

# Operating Instructions

Liquid Crystal Video Monitor

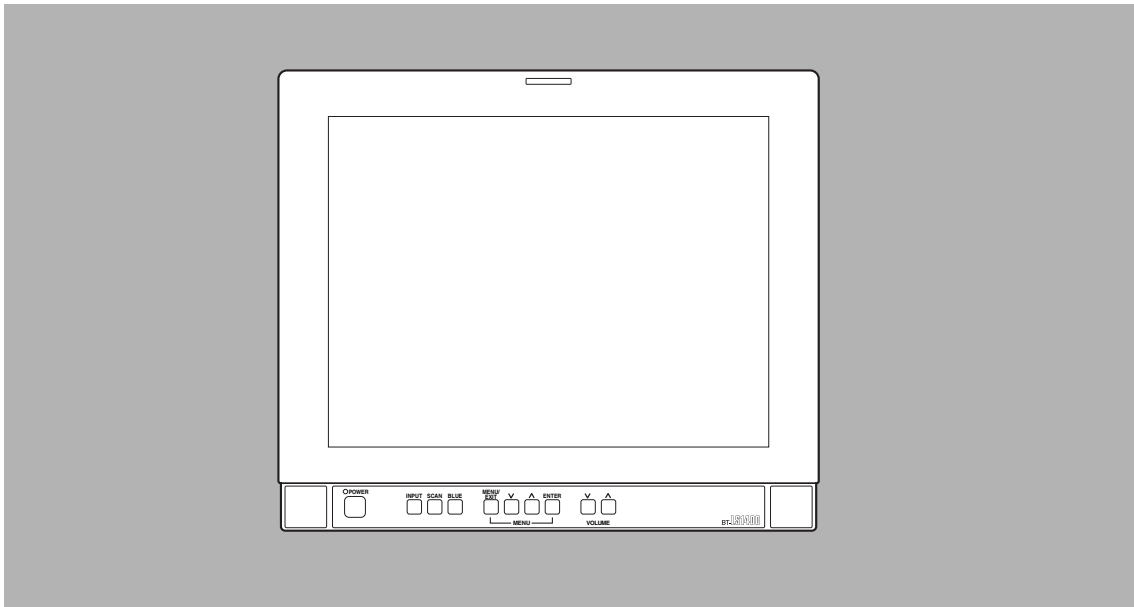

BT-LS1400P



## Panasonic®

Before attempting to connect, operate or adjust this product, please read these instructions completely.

# For your safety

|   |   |   |
|---|---|---|
|    | <b>CAUTION</b><br>RISK OF ELECTRIC SHOCK<br>DO NOT OPEN |  |
| CAUTION: TO REDUCE THE RISK OF ELECTRIC SHOCK,<br>DO NOT REMOVE COVER (OR BACK).<br>NO USER SERVICEABLE PARTS INSIDE.<br>REFER TO SERVICING TO QUALIFIED SERVICE PERSONNEL. |   |   |



The lightning flash with arrowhead symbol, within an equilateral triangle, is intended to alert the user to the presence of uninsulated "dangerous voltage" within the product's enclosure that may be of sufficient magnitude to constitute a risk of electric shock to persons.



The exclamation point within an equilateral triangle is intended to alert the user to the presence of important operating and maintenance (service) instructions in the literature accompanying the appliance.

## **WARNING:**

**TO REDUCE THE RISK OF FIRE OR SHOCK HAZARD, DO NOT EXPOSE THIS EQUIPMENT TO RAIN OR MOISTURE AND KEEP THIS EQUIPMENT AWAY FROM ALL LIQUIDS—USE AND STORE ONLY IN LOCATIONS WHICH ARE NOT EXPOSED TO THE RISK OF DRIPPING OR SPLASHING LIQUIDS, AND DO NOT PLACE ANY LIQUID CONTAINERS ON TOP OF THE EQUIPMENT.**

## **CAUTION:**

**TO REDUCE THE RISK OF FIRE OR SHOCK HAZARD AND ANNOYING INTERFERENCE, USE THE RECOMMENDED ACCESSORIES ONLY.**

## **CAUTION:**

**TO REDUCE THE RISK OF FIRE OR SHOCK HAZARD, REFER MOUNTING OF THE OPTIONAL UNIT TO AUTHORIZED SERVICE PERSONNEL.**

## **FCC Note:**

This device complies with Part 15 of the FCC Rules. To assure continued compliance follow the attached installation instructions and do not make any unauthorized modifications.

This equipment has been tested and found to comply with the limits for a class A digital device, pursuant to Part 15 of the FCC Rules. These limits are designed to provide reasonable protection against harmful interference when the equipment is operated in a commercial environment. This equipment generates, uses, and can radiate radio frequency energy and, if not installed and used in accordance with the instruction manual, may cause harmful interference to radio communications. Operation of this equipment in a residential area is likely to cause harmful interference in which case the user will be required to correct the interference at his own expense.

## **Notice (U.S.A. only):**

**This product has a fluorescent lamp that contains a small amount of mercury.**

**It also contains lead in some components. Disposal of these materials may be regulated in your community due to environmental considerations.**

**For disposal or recycling information please contact your local authorities, or the Electronics Industries Alliance:**

**<<http://www.eiae.org>.>**

## **CAUTION:**

**Do not install or place this unit in a bookcase, built-in cabinet or any other confined space in order to maintain adequate ventilation. Ensure that curtains and any other materials do not obstruct the ventilation to prevent risk of electric shock or fire hazard due to overheating.**

 indicates safety information.

# For your safety

---

■ **THIS APPARATUS MUST BE GROUNDED**

To ensure safe operation the three-pin plug must be inserted only into a standard three-pin power outlet which is effectively grounded through normal household wiring.

Extension cords used with the equipment must be three-core and be correctly wired to provide connection to the ground. Incorrectly wired extension cords can be extremely hazardous.

The fact that the equipment operates satisfactorily does not imply that it is grounded, and the installation is not necessarily safe. For your safety, if in any doubt about the effective grounding of the equipment or power outlet, please consult a qualified electrician.

**CAUTION:**

**THE SOCKET-OUTLET SHALL BE INSTALLED NEAR THE EQUIPMENT AND SHALL BE EASILY ACCESSIBLE.**

**CAUTION:**

**THIS APPARATUS CAN BE OPERATED AT A VOLTAGE OF 120 V OR ON THE RANGE OF 220 – 240 V AC. OPERATION AT A VOLTAGE IN THE RANGE OF 220 – 240 V AC IS NOT INTENDED FOR U.S.A.**

**CAUTION:**

**OPERATION AT A VOLTAGE IN THE RANGE OF 220 – 240 V AC MAY REQUIRE THE USE OF A DIFFERENT AC PLUG.**

**PLEASE CONTACT EITHER A LOCAL OR FOREIGN PANASONIC DISTRIBUTOR FOR ASSISTANCE IN SELECTING AN ALTERNATE AC PLUG.**

 indicates safety information.

## Contents

---

|  |           |
|--|-----------|
| <b>For your safety .....</b>                           | <b>2</b>  |
| <b>Precautions for use .....</b>                       | <b>4</b>  |
| <b>Outline drawings of front and side panels .....</b> | <b>4</b>  |
| <b>Introduction .....</b>                              | <b>5</b>  |
| <b>Parts and their functions (front panel) .....</b>   | <b>5</b>  |
| <b>Parts and their functions (rear panel) .....</b>    | <b>6</b>  |
| <b>How to use the on-screen menus .....</b>            | <b>7</b>  |
| <b>REMOTE specifications .....</b>                     | <b>10</b> |
| <b>About the stand .....</b>                           | <b>11</b> |
| <b>Rack mounting .....</b>                             | <b>11</b> |
| <b>Maintenance .....</b>                               | <b>12</b> |
| <b>Specifications .....</b>                            | <b>13</b> |

# Precautions for use

---

This product has been specially designed for commercial use. As such, it should be used and operated only by persons with related expertise.

- The liquid crystal parts are fabricated using high-precision technology. The screen has effective pixels that cover more than 99.99% of its area, but pixels may be missing or remain permanently lighted (red, blue and/or green) in less than 0.01% of the area. This is not indicative of malfunctioning.
- The LCD panel has been specially finished.  
Do not wipe it with hard cloths or rub it heavily as this will damage the surface of the panel.
- If a still image is displayed continuously for a long period of time, the image may be burnt onto the screen for some time. (The shadow of the image will usually disappear after moving images are displayed for while.)
- The response speed and brightness of the liquid crystals will vary with the surrounding temperature.

## Outline drawings of front and side panels

---

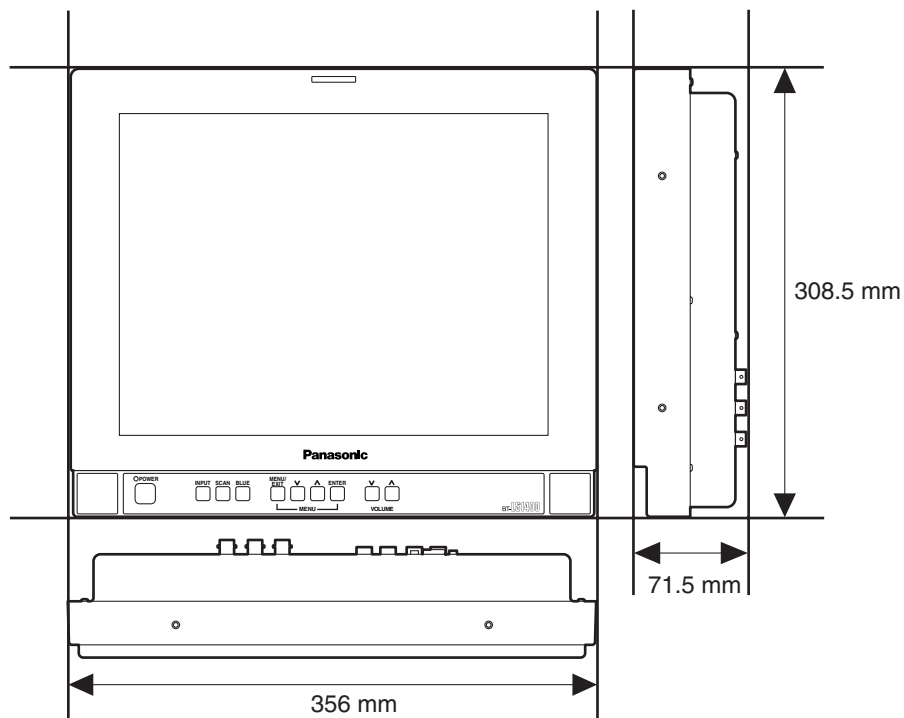

# Introduction

The BT-LS1400 commercial-use LCD video monitor features a 14 v-type LCD screen, a slim and lightweight design, and a wide angle of view. Its connectors support not only standard NTSC signal input but S-Video, 480i, P component signal input and SD SDI (optional) input as well.

## ■ Wide angle of view

By using an LCD screen with a wide angle of view, exceptional image visibility is assured across wide angle ranges in both the top-bottom and left-right directions.

## ■ Color temperature, gamma correction

The color temperature complies with the D65 and D93 standards while gamma correction is set to the 2.2 curve.

## ■ Mode settings

Users can choose between three modes: the image production mode (BROADCAST), the general user image-receiving mode (GENERAL), and the user setting mode (USER).

## ■ Functions

This monitor is equipped with a blue-only function for adjusting the hue, and an underscanning function for displaying the whole screen.

## ■ REMOTE connector

This enables parallel remote input control which in turn makes it possible to select functions.

# Parts and their functions (front panel)

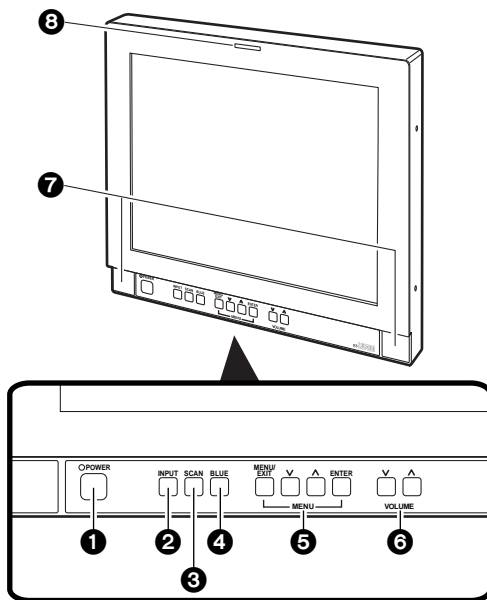

## ① Power switch

This is the main power switch. When the power is ON, the LED (green) above the switch lights.

## ② INPUT selector button

This is used to select the signal input, and each time it is pressed, the input is switched in the following sequence: LINE A → LINE B → CMPNT → SDI → LINE A.

### <Note>

The SDI signal input can be selected only when the BT-YA210G, available as an optional accessory, is installed.

## ③ SCAN button

**UNDER SCAN:** At this setting, signals in the video signal standard area can be viewed.

**OVER SCAN:** This setting provides overscanning of around 8% so that about 85% of the video signal standard area is displayed.

Overscanning displays are used by consumer products although their scanning ratio differs from product to product.

## ④ BLUE ONLY button

The chroma and phase can be adjusted more accurately using SMPTE color bars when this button is pressed.

## ⑤ MENU selector buttons

These are used to display the menus and perform the adjustments and settings.

**MENU/EXIT:** Press this button to exit the menu display and menu. Further, if this button is pressed after the menu item has been selected, the menu will be exited with the item entered.

**^ v:** Press these buttons to move the cursor up or down or to select menu items.

**ENTER:** Press this button to select menu items or enter settings.

## ⑥ Volume controls

The volume level is altered by pressing the up (^) and down (v) buttons.

## ⑦ Speaker

## ⑧ Tally lamp

The lamp (red) lights due to remote control operation. See "REMOTE specifications" (page 10) for details.

# Parts and their functions (rear panel)

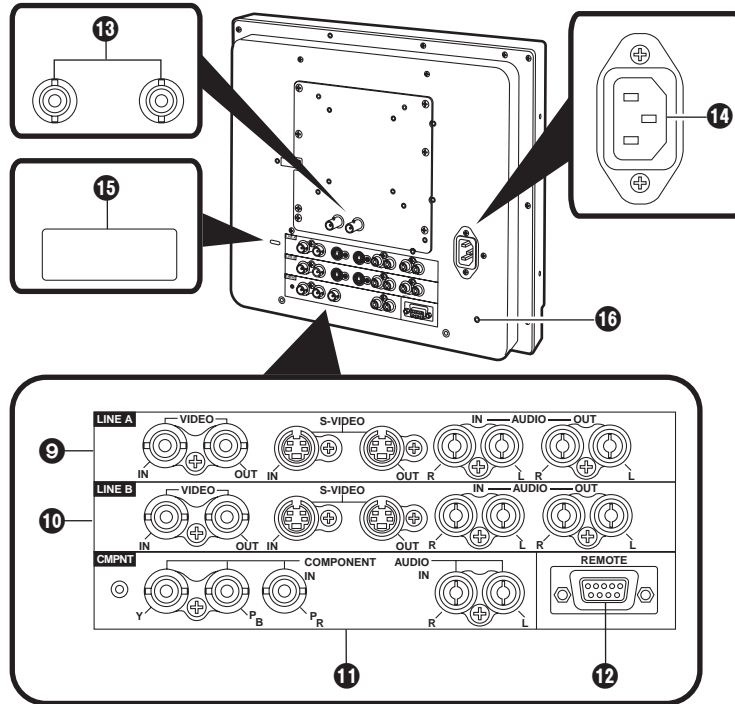

## 9 LINE-A

These connectors are for composite signal and S-video signal and audio signal input. Priority is given to the S-video signal for input.

## 10 LINE-B

These connectors are for composite signal and S-video signal and audio signal input. Priority is given to the S-video signal for input.

## 11 CMPNT

These connectors are for component signal input and audio signal input. When the option SDI input unit BT-YA210G is installed, these connectors are also used for SDI audio input.

### <Note>

It is recommended to use the Y CMPNT connector for input of monochrome signals.

## 12 REMOTE connector

This 9-pin, D-sub connector is for remote control purposes.

## 13 SD-SDI connectors (optional)

These are SD-SDI input connectors (BNC) with active thru output.

## 14 AC IN power socket

This is the AC power socket. Connect the accessory power cord here.

## 15 Security lock

This can be used to connect a commercially-available theft-prevention cable (manufactured by Kensington). This security lock is compatible with the Microsaver Security System from Kensington.

Contact details for this company are given below.

KensingtonTechnology Group ACCO Brrands Inc.

2855 Campus Drive San Mateo, CA 94403 USA

Tel (650)572-2700

Fax(650)572-9675

<http://www.kensington.com/>

<http://www.gravis.com/>

NOTE: information given above may be changed in future.

## 16 Screw hole for cable clamp

This screw hole is for attaching the clamp for the power cord. Refer to the following when attaching the clamp.

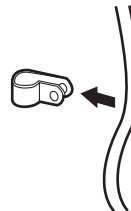

Place the power cord in the accessory clamp.

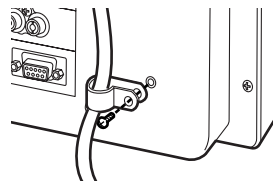

Fix the clamp to the monitor using the screw provided.

# How to use the on-screen menus

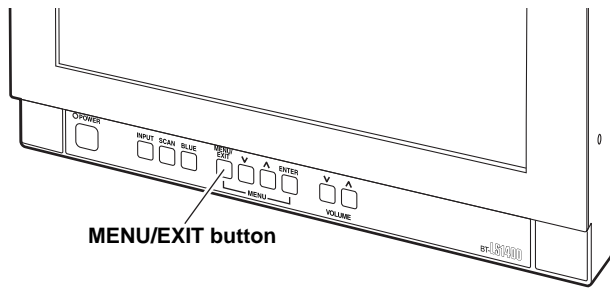

Press the MENU/EXIT button to display the main menu on the screen.

## ■ Menus

The following items appear on the main menu.

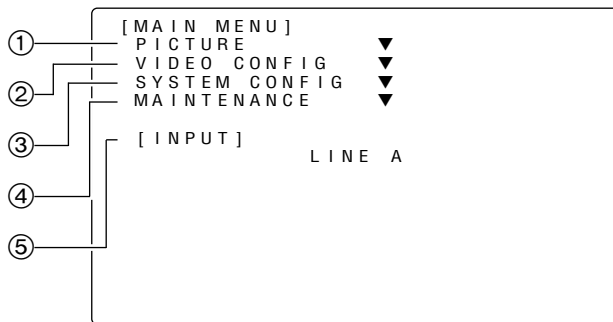

- ① **PICTURE**  
This menu is used to perform the settings relating to the picture.
- ② **VIDEO CONFIG**  
This menu is used to perform aspect and component input level settings.
- ③ **SYSTEM CONFIG**  
This menu is used to set the backlight brightness, status displays, input switching skip and REMOTE ON or OFF.
- ④ **MAINTENANCE**  
This menu is used to display the running time of the LCD monitor.
- ⑤ **[INPUT]**  
The currently selected signal—whether LINE A, LINE B, CMPNT or SDI (optional)—is displayed here.

# How to use the on-screen menus

## ● PICTURE menu

The menu items shown below appear when the PICTURE menu is selected on the main menu.

|                  |           |
|------------------|-----------|
| [ PICTURE MENU ] |           |
| MODE             | BROADCAST |
| CONTRAST         | 60        |
| BRIGHT           | 30        |
| CHROMA           | 30        |
| PHASE            | 30        |
| SHARPNESS        | 30        |
| AI               | OFF       |
| NR               | OFF       |
| COLOR TEMP       | D93       |
| 3D Y/C           | OFF       |
| [ LOAD FACTORY ] |           |

### MODE

The video mode is selected here.

- **BROADCAST**  
This mode is set at the factory to best suit broadcast operations.
- **GENERAL**  
This mode applies the dynamic settings which were set at the factory for generally receiving images.
- **USER**  
This mode enables the mode set by the user to be established. BROADCAST is the factory setting.

### CONTRAST

The contrast can be adjusted here in line with the conditions of the indoor work environment.

### BRIGHT

The black level can be adjusted here.

### CHROMA

The chroma level can be adjusted here.

Use the blue-only function to adjust the level while viewing the SMPTE color bars.

### PHASE

The phase can be adjusted here.

Use the blue-only function to adjust the level while viewing the SMPTE color bars.

### SHARPNESS

The appropriate sharpness in line with the signal characteristics can be set here.

### AI

Dynamic images can be received when this is set to ON.

### NR

This is set to ON when the signal-to-noise ratio for the video signals received is problematic.

### COLOR TMP

The color temperature can be adjusted here.

The color temperature is adjusted to comply with the D65 and D93 standards at the factory.

For consumer products, the color temperature is normally set higher.

### 3D Y/C

This is for the 3-dimensional Y/C separation function.

The picture quality is different when the function is ON and when it is OFF.

### LOAD FACTORY

This is selected when the factory settings are to be restored.

### <Notes>

When any changes are made to the settings on this menu, the changes also take effect for the settings of other linked video signals for some of the video signals which have been selected. How the changes are linked is explained below.

- Any changes made to the settings when the LINE A signal has been selected will also be made to the LINE B signal. Conversely, any changes made to the settings when the LINE B signal has been selected will also be made to the LINE A signal.
- When the optional SDI input unit (BT-YA210G) is installed, any changes made to the settings when the CMPNT 480i signal is selected will also be made to the SDI signal. Conversely, any changes made to the settings when the SDI signal is selected will also be made to the CMPNT 480i signal.



# How to use the on-screen menus

---

## ● VIDEO CONFIG menu

The menu items shown below appear when the VIDEO CONFIG menu is selected on the main menu.

```
[ VIDEO CONFIG ]
ASPECT          16:9
COMPONENT LEVEL SMPTE
```

### ASPECT

An aspect ratio of 4:3 or 16:9 can be set.

The underscanning function cannot be used when 16:9 has been selected.

### COMPONENT LEVEL

The component input level is selected here. This menu item appears only when the component signal has been selected as the input signal.

- **SMPTE**

Select this when signals from a DVD or MII VTR are supplied.

- **B75**

Select this when signals with a 7.5% setup level are supplied from a Betacam VTR.

---

## ● SYSTEM CONFIG menu

The menu items shown below appear when the SYSTEM CONFIG menu is selected on the main menu.

```
[ SYSTEM CONFIG ]
BACKLIGHT          60
STATUS DISPLAY CONTINUE
[ INPUT SELECT ]
LINE B             ON
CMPNT              ON
SDI                ON
REMOTE            OFF
```

### INPUT SELECT

#### LINE B

By setting this item to OFF, LINE B can be skipped.

#### CMPNT

By setting this item to OFF, CMPNT can be skipped.

#### SDI

By setting this item to OFF, SDI can be skipped. This item is valid only when the optional SDI input unit (BT-YA210G) is installed.

### REMOTE

External control is set to ON or OFF here.

### BACKLIGHT

The backlight brightness is adjusted to a value from 0 to 60 here. 60 is the factory setting.

### STATUS DISPLAY

The information displays during input switching and input signal system display are set here.

- **CONTINUE**

The information remains displayed. This is the factory setting.

- **3 SEC OFF**

The information is displayed for 3 seconds, after which it is cleared from the display.

- **OFF**

No information is displayed.

# How to use the on-screen menus

## ● MAINTENANCE menu

The menu item shown below appears when the MAINTENANCE menu is selected on the main menu.

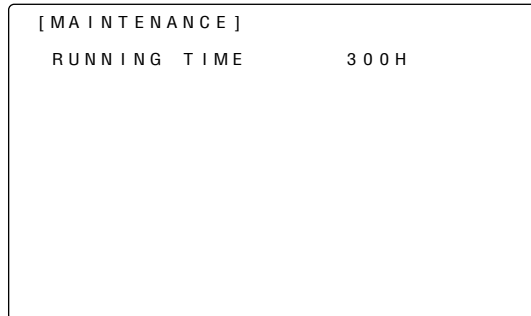

### RUNNING TIME

The total running time of the monitor is displayed here (in hours).

## REMOTE specifications

In order to perform REMOTE operations, select ON as the setting for the REMOTE menu item on the SYSTEM CONFIG menu.

The functions for REMOTE operations can be switched by opening or shorting the pins corresponding to the functions to pin 5 (ground). There are two kinds of operations: level operations and edge operations.

**Level operations** : The functions are operational while the pins are shorted to pin 5 (GND).

**Edge operations** : The functions become operational when the pins are transferred from an open-circuited to short-circuited state vis-à-vis pin 5 (GND).

The following four functions can be controlled externally.

- **Input switching function (edge operations)**  
This switches the input from LINE A, LINE B, CMPNT or SDI. The SDI signal input can be selected only when the BT-YA210G, available as an optional accessory, is installed. The input signals which have been set to OFF (which are to be skipped) under the INPUT SIGNAL menu item on the SYSTEM CONFIG menu will not be displayed, thus making it impossible for them to be selected.
- **Aspect ratio switching function (level operations)**  
This switches the aspect ratio.
- **Standby function (level operations)**  
This blacks out the monitor while the power is on in order to prevent images from being burned onto the screen.
- **Tally function (level operations)**  
This enables the tally lamp to light up red.  
The tally lamp operates regardless of whether ON or OFF is selected as the REMOTE menu item setting.

Connector (9P)

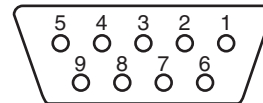

| Pin No. | Signal                          |
|---------|---------------------------------|
| 1       | Input switching function        |
| 2       | Aspect ratio switching function |
| 3       | Standby function                |
| 4       | Tally function                  |
| 5       | GND                             |
| 6       | —                               |
| 7       | —                               |
| 8       | —                               |
| 9       | —                               |

# About the stand

The stand attached to the unit can be tilted forward 10° and back 20°.

When tilting the monitor, firmly press down on the stand and grasp the top part of the monitor.

Further, it is recommended to secure the stand using the screw holes when it is to be permanently located.

**<Note>**

Take care not to catch your fingers or hands when tilting the stand.

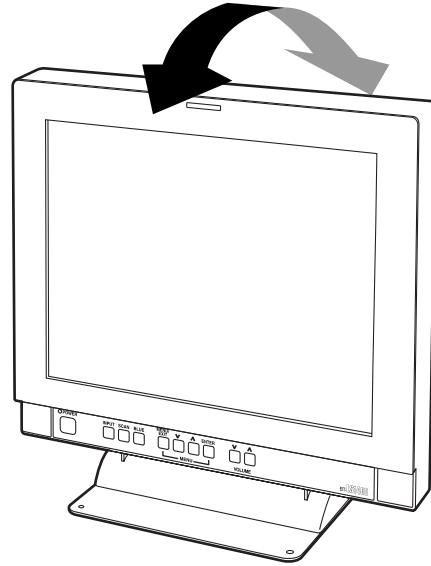

# Rack mounting

The unit can be mounted into a 19-inch standard rack (height: 7U size) if the optional rack-mounting adaptors (BT-MA1400G) are used. Refer to the following when attaching the adaptors.

- 1** Remove the stand from the main monitor unit.

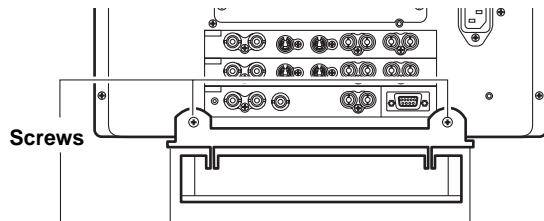

- 2** Remove the six screws from the monitor.

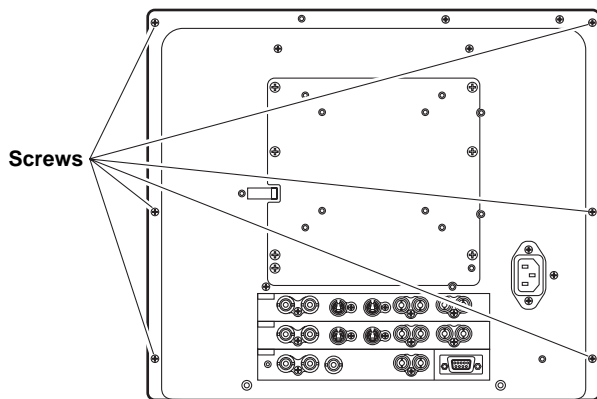

- 3** Attach the BT-MA1400G rack mount adaptor using the two screws which were removed in step 1 and six screws which were removed in step 2.

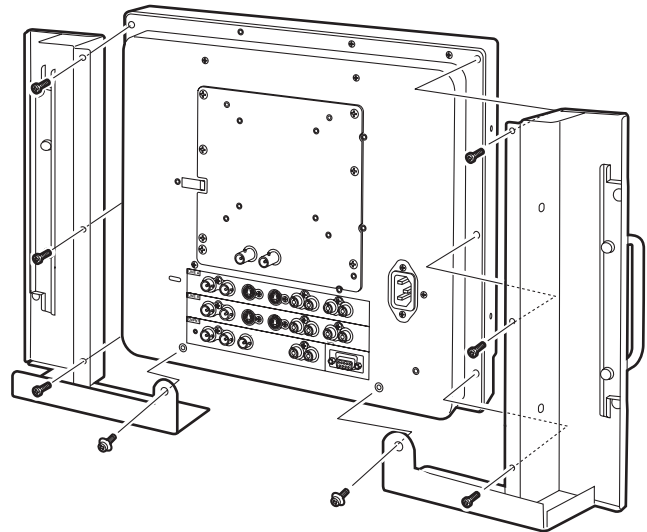

**<Note>**

Keep the temperature inside the rack to between +41 °F (5 °C) and +95 °F (35 °C).

# Maintenance

---

- **Wipe off any dust or dirt on the monitor and LCD panel with a soft cloth.**

For stubborn dirt or stains, wipe the monitor and LCD panel with a cloth that has been lightly dampened with well-diluted kitchen detergent and wrung out thoroughly, then finish it off with a dry cloth. The monitor may malfunction if even one drop of water gets into the internals.

- **Do not spray detergent or other cleaners directly on the monitor or LCD panel.**

The monitor may malfunction if even one drop of water gets into the internals.

# Specifications

---

## [GENERAL]

|  |
|--|
| <b>Power supply:</b> AC 100 V to 240 V, 50-60 Hz |
| <b>Power consumption:</b> 0.98 A to 0.54 A       |

 indicates safety information.

### Dimensions (W×H×D):

14 × 12-1/8 × 2-13/16 inch (main unit only)  
(356 × 308.5 × 71.5 mm)  
14 × 13-3/8 × 7-3/8 inch (with monitor stand)  
(356 × 340 × 187 mm)

### Weight:

10.5 lbs (4.6 kg) (main unit only)  
12.4 lbs (5.6 kg) (with monitor stand)

### Ambient operating temperature:

41 °F to 95 °F (5°C to 35°C)

### Ambient operating humidity:

20% to 80% (no condensation)

### Ambient temperature for storage:

-4 °F to 140 °F (-20°C to +60°C)

### Ambient humidity for storage:

10% to 90% (no condensation)

## [Panel]

### Number of pixels:

921,600 (640 (H) x 480 (V) ,RGB)

### Angle of view:

Top-bottom direction: 160°;  
left-right direction: 160°

### Screen dimensions (W×H):

288 × 217 (mm) (4:3 aspect)

## [Video signal input]

### LINE A:

NTSC composite (BNC)  
1.0 Vp-p  
S video signals (S connector prioritized)  
Y: 1.0 Vp-p C: 0.268 Vp-p

### LINE B:

NTSC composite (BNC)  
1.0 Vp-p  
S-video signals (S connector prioritized)  
Y: 1.0 Vp-p C: 0.268 Vp-p

### CMPNT:

Y: 1.0 Vp-p PbPr: 0.7 Vp-p  
(BNC, 480/59.94i, 480/59.94P)

### SDI (optional):

Component serial digital (BNC, 480/59.94i)

## [Video signal output]

### LINE A:

Loop-through output, 75 Ω automatic termination  
(BNC, S connector)

### LINE B:

Loop-through output, 75 Ω automatic termination  
(BNC, S connector)

### SDI (optional):

Buffer output (BNC, 480/59.94i)

## [Audio input]

### LINE A:

L/R input (RCA, phono pin), 0.5 Vrms

### LINE B:

L/R input (RCA, phono pin), 0.5 Vrms

### CMPNT:

L/R input (RCA, phono pin), 0.5 Vrms

### SDI (optional):

Audio signals for CMPNT input

## [Audio output]

### LINE A:

Loop-through output, L/R (RCA, phono pin)

### LINE B:

Loop-through output, L/R (RCA, phono pin)

### Speakers:

Stereo (1 W + 1 W)

## [Other]

### REMOTE:

D-sub, 9 pin

## [Accessories provided with the monitor]

Power cable × 1

Operating Instructions × 1

Cable clamp × 1

Screw for cable clamp × 1

# *Memo*

# *Memo*

---

# Panasonic

**PANASONIC BROADCAST & TELEVISION SYSTEMS COMPANY**  
UNIT COMPANY OF MATSUSHITA ELECTRIC CORPORATION OF AMERICA

**Executive Office:**

One Panasonic Way 4E-7, Secaucus, NJ 07094 (201) 348-7000

**EASTERN ZONE:**

One Panasonic Way 4E-7, Secaucus, NJ 07094 (201) 348-7621

**Southeast Region:**

1225 Northbrook Parkway, Ste 1-160, Suwanee, GA 30024 (770) 338-6835

**Central Region:**

1707 N Randall Road E1-C-1, Elgin, IL 60123 (847) 468-5200

**WESTERN ZONE:**

3330 Cahuenga Blvd W., Los Angeles, CA 90068 (323) 436-3500

**Government Marketing Department:**

52 West Gude Drive, Rockville, MD 20850 (301) 738-3840

**Broadcast PARTS INFORMATION & ORDERING:**

9:00 a.m. – 5:00 p.m. (EST) (800) 334-4881/24 Hr. Fax (800) 334-4880

Emergency after hour parts orders (800) 334-4881

**TECHNICAL SUPPORT:**

Emergency 24 Hour Service (800) 222-0741

**Panasonic Canada Inc.**

5770 Ambler Drive, Mississauga, Ontario L4W 2T3 (905) 624-5010

**Panasonic de Mexico S.A. de C.V.**

Av angel Urraza Num. 1209 Col. de Valle 03100 Mexico, D.F. (52) 1 951 2127

**Panasonic Sales Company**

**Division of Matsushita Electric of Puerto Rico Inc.**

San Gabriel Industrial Park, 65th Infantry Ave., Km. 9.5, Carolina, Puerto Rico 00630 (787) 750-4300

