



Hedge Clipper

Operator's Manual

MODEL

HC-150

Serial Number 07001001 - 07999999

WARNING  **DANGER**



The muffler or catalytic muffler and surrounding cover may become extremely hot.

Always keep clear of exhaust and muffler area, otherwise serious personal injury may occur.



WARNING



The engine exhaust from this product contains chemicals known to the State of California to cause cancer, birth defects or other reproductive harm.



WARNING  **DANGER**

Read rules for safe operation and all instructions carefully. ECHO provides this Operator's Manual and a Safety Manual. Both must be read and understood for proper and safe operation.

INTRODUCTION

Welcome to the ECHO family. This ECHO product was designed and manufactured to provide long life and on-the-job dependability. Read and understand this manual. You will find it easy to use and full of helpful operating tips and SAFETY messages.

THE OPERATOR'S MANUAL

Read and understand this manual before operation. Keep it in a safe place for future reference. It contains specifications and information for operation, starting, stopping, maintenance, storage, and assembly specific to this product.

THE SAFETY MANUAL

Read and understand this manual before operation. Keep it in a safe place for future reference. It explains possible hazards involved with the use of this product and what measures you should take to make their use safer.

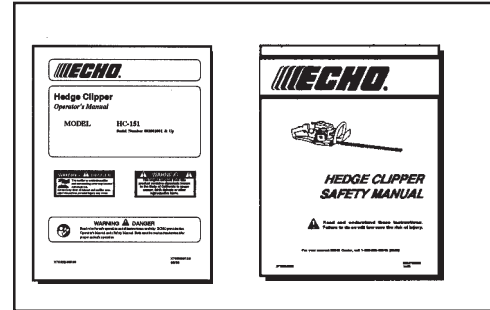



TABLE OF CONTENTS

Introduction	2	- Stopping Engine	13
- The Operator's Manual	2	- Hedge Trimming	14
- The Safety Manual	2	Maintenance	14
Manual Safety Symbols and Important Information	3	- Skill Levels	14
Safety	3	- Maintenance Intervals	15
- Decals	3	- Air Filter	16
- International Symbols	4	- Fuel Filter	16
Safety Instructions	4	- Spark Plug	17
- Personal Conditions and Safety Equipment	4	- Cooling System	17
- Extended Operation/Extreme Conditions	5	- Exhaust System	18
- Equipment	5	- Carburetor Adjustment	19
- Safe Operation	6	- Lubrication	20
Emissions Control	6	- Sharpening Blades	21
Description	7	Troubleshooting	22
- Contents	7	Storage	23
Specifications	9	Servicing Information	24
Assembly	10	- Parts	24
- Install Blade Stiffener	10	- Service	24
- Remove Blade Stiffener	10	- ECHO Consumer Product Support	24
Pre-Operation	11	- Warranty Card	24
- Fuel	11	- Additional or Replacement Manuals	24
Operation	12		
- Starting Cold Engine	12		
- Starting Warm Engine	13		

Specifications, descriptions and illustrative material in this literature are as accurate as known at the time of publication, but are subject to change without notice. Illustrations may include optional equipment and accessories, and may not include all standard equipment.

MANUAL SAFETY SYMBOLS AND IMPORTANT INFORMATION

Throughout this manual and on the product itself, you will find safety alerts and helpful, informational messages preceded by symbols or key words. The following is an explanation of those symbols and key words and what they mean to you.

 This symbol accompanied by the words **WARNING** and **DANGER** calls attention to an act or condition that can lead to serious personal injury to operator and bystanders.

 The circle with the slash symbol means whatever is shown within the circle is prohibited.

 **IMPORTANT**

 **NOTE**

IMPORTANT
The enclosed message provides information necessary for the protection of the unit.

NOTE
This enclosed message provides tips for use, care and maintenance of the unit.

SAFETY

DECALS

Locate these safety decals on your unit. Make sure the decals are legible and that you understand and follow the instructions on them. If a decal cannot be read, a new one can be ordered from your ECHO dealer. See PARTS ORDERING instructions for specific information.

Hot Decal (near muffler)

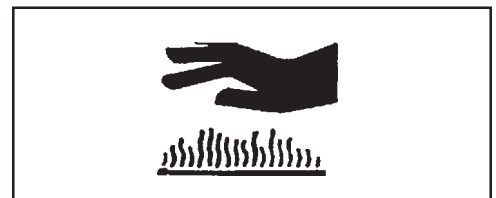

P/N 89016006361

Right Front Handle Guard

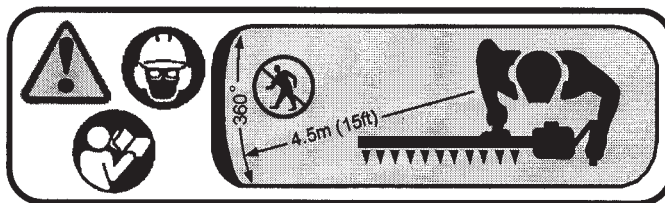

P/N X505000270



P/N X505000290

INTERNATIONAL SYMBOLS

Symbol form/shape	Symbol description/application	Symbol form/shape	Symbol description/application
	Read and understand owners manual.		Fuel and oil mixture
	Wear eyes, ears and head protection		Finger Severing
	Emergency stop		Hot Surface
	Wear hand protection. Use two handed.		DO NOT smoke near fuel.
	Choke Control "Cold Start" Position (Choke Closed)	Ignition 	Ignition ON/OFF
	Choke Control "Run" Position (Choke Open)		Do not operate without guards in place.

Symbol form/shape	Symbol description/application	Symbol form/shape	Symbol description/application
	Carburetor adjustment - Low speed mixture		Carburetor adjustment - High speed mixture
	Safety/Alert		Carburetor adjustment - Idle speed
	Avoid all power lines. This unit is not insulated against electrical current.		Do not operate closer than 15 M (50 ft.) from electrical hazards.
	Plan retreat path from falling objects.		Primer bulb
	DO NOT allow flames or sparks near fuel.		Wear slip resistant foot wear.
		Keep bystanders at least 4.5 meters (15 feet) away.	

SAFETY INSTRUCTIONS

PERSONAL CONDITION AND SAFETY EQUIPMENT

WARNING DANGER

Users of this product risk injury to themselves and others if the unit is used improperly and/or safety precautions are not followed. Proper clothing and safety gear must be worn when operating unit.

Physical Condition

Your judgment and physical dexterity may not be good:

- if you are tired or sick,
- if you are taking medication,
- if you have taken alcohol or drugs.

Operate unit only if you are physically and mentally well.

Eye Protection

Wear eye protection that meets ANSI Z87.1 or CE requirements whenever you operate the unit.

Hand Protection

Wear no-slip, heavy-duty work gloves to improve your grip on the handle. Gloves also reduce the transmission of machine vibration to your hands.

Hearing Protection

ECHO recommends wearing hearing protection whenever unit is used.

Proper Clothing

Wear snug fitting, durable clothing:

- Pants should have long legs, shirts with long sleeves.
- DO NOT WEAR SHORTS,
- DO NOT WEAR TIES, SCARVES, and JEWELRY.

Wear sturdy work shoes with nonskid soles:

- DO NOT WEAR OPEN TOED SHOES,
- DO NOT OPERATE UNIT BAREFOOTED.

Keep long hair away from engine and blower intake.

Retain hair with cap or net.

Hot Humid Weather

Heavy protective clothing can increase operator fatigue, which may lead to heat stroke. Schedule heavy work for early morning or late afternoon hours when temperatures are cooler.

EXTENDED OPERATION/EXTREME CONDITIONS

Vibration and Cold

It is believed that a condition called Raynaud's Phenomenon, which affects the fingers of certain individuals, may be brought about by exposure to vibration and cold. Exposure to vibration and cold may cause tingling and burning sensations, followed by loss of color and numbness in the fingers. The following precautions are strongly recommended, because the minimum exposure, which might trigger the ailment, is unknown.

- Keep your body warm, especially the head, neck, feet, ankles, hands, and wrists.
- Maintain good blood circulation by performing vigorous arm exercises during frequent work breaks, and also by not smoking.
- Limit the hours of operation. Try to fill each day with jobs where operating the unit or other hand-held power equipment is not required.
- If you experience discomfort, redness, and swelling of the fingers followed by whitening and loss of feeling, consult your physician before further exposing yourself to cold and vibration.

Repetitive Stress Injuries

It is believed that overusing the muscles and tendons of the fingers, hands, arms, and shoulders may cause soreness, swelling, numbness, weakness, and extreme pain in those areas. Certain repetitive hand activities may put you at a high risk for developing a Repetitive Stress Injury (RSI). An extreme RSI condition is Carpal Tunnel Syndrome (CTS), which could occur when your wrist swells and squeezes a vital nerve that runs through the area. Some believe that prolonged exposure to vibration may contribute to CTS. CTS can cause severe pain for months or even years.

To reduce the risk of RSI/CTS, do the following:

- Avoid using your wrist in a bent, extended, or twisted position. Instead try to maintain a straight wrist position. Also, when grasping, use your whole hand, not just the thumb and index finger.
- Take periodic breaks to minimize repetition and rest your hands.
- Reduce the speed and force with which you do the repetitive movement.
- Do exercise to strengthen the hand and arm muscles.
- Immediately stop using all power equipment and consult a doctor if you feel tingling, numbness, or pain in the fingers, hands, wrists, or arms. The sooner RSI/CTS is diagnosed, the more likely permanent nerve and muscle damage can be prevented.

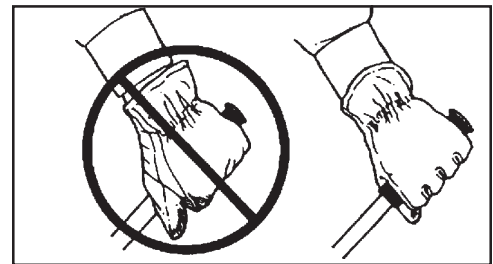

EQUIPMENT

WARNING  DANGER

Use only ECHO approved attachments. Serious injury may result from the use of a non-approved attachment combination. ECHO, INC. will not be responsible for the failure of cutting devices, attachments, or accessories which have not been tested and approved by ECHO. Read and comply with all safety instructions listed in this manual and safety manual.

- Check unit for loose/missing nuts, bolts, and screws. Tighten and/or replace as needed.
- Inspect fuel lines, tank and area around carburetor for fuel leaks. DO NOT operate unit if leaks are found.
- Inspect hand guard for damage. Replace if damaged or missing.
- Check that the blade assembly is firmly attached and in safe operating condition. Dull, loose or damaged blades should not be used.

SAFE OPERATION

WARNING DANGER

Do not operate this product indoors or in inadequately ventilated areas. Engine exhaust contains poisonous emissions and can cause serious injury or death.

Read the Manuals

- Provide all users of this equipment with the Operator's Manual and Safety Manual for instructions on Safe Operation.

Clear the Work Area

- Spectators and fellow workers must be warned, and children and animals prevented from coming nearer than 15 m (50 ft.) while the unit is in use.

Keep a Firm Grip

- Hold the front and rear handles with both hands, with thumbs and fingers encircling the handles.

Keep a Solid Stance

- Maintain footing and balance at all times. Do not stand on slippery, uneven or unstable surfaces. Do not work in odd positions or on ladders. Do not over reach.

Avoid Hot Surfaces

- Keep exhaust area clear of flammable debris. Avoid contact during and immediately after operation.

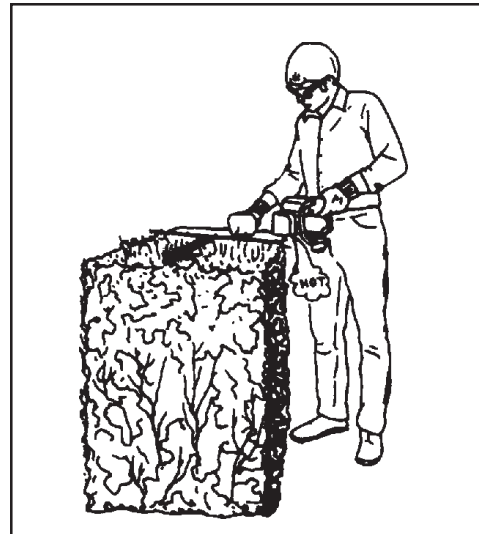

WARNING DANGER

Never perform blade maintenance procedures while engine is running.

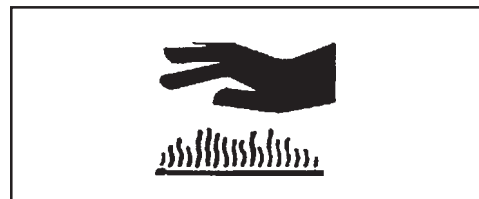

EMISSION CONTROL

EPA Phase 2

The emission control system for this engine is EM (Engine Modification).

Emission Control Label (located on Engine) (EXAMPLE ONLY, information on label varies by FAMILY).

IMPORTANT ENGINE INFORMATION

ENGINE FAMILY: 4EHXS.0214ED DISPLACEMENT: 21.2 cc
EMISSION COMPLIANCE PERIOD : 300 HRS.
THIS ENGINE MEETS U.S. EPA PHA 2 EMISSION REGULATIONS FOR SMALL NON ROAD ENGINE. REFER TO OWNER'S MANUAL FOR MAINTENANCE SPECIFICATIONS AND ADJUSTMENTS.



PRODUCT EMISSION DURABILITY

The 300 hour emission durability compliance period is the time span selected by the manufacturer certifying the engine emissions output meets applicable emissions regulations, provided that approved maintenance procedures are followed as listed in the Maintenance Section of this manual.



DESCRIPTION

After opening the carton, check for damage. Immediately notify your retailer or ECHO Dealer of damaged or missing parts. Use the contents list to check for missing parts.

CONTENTS

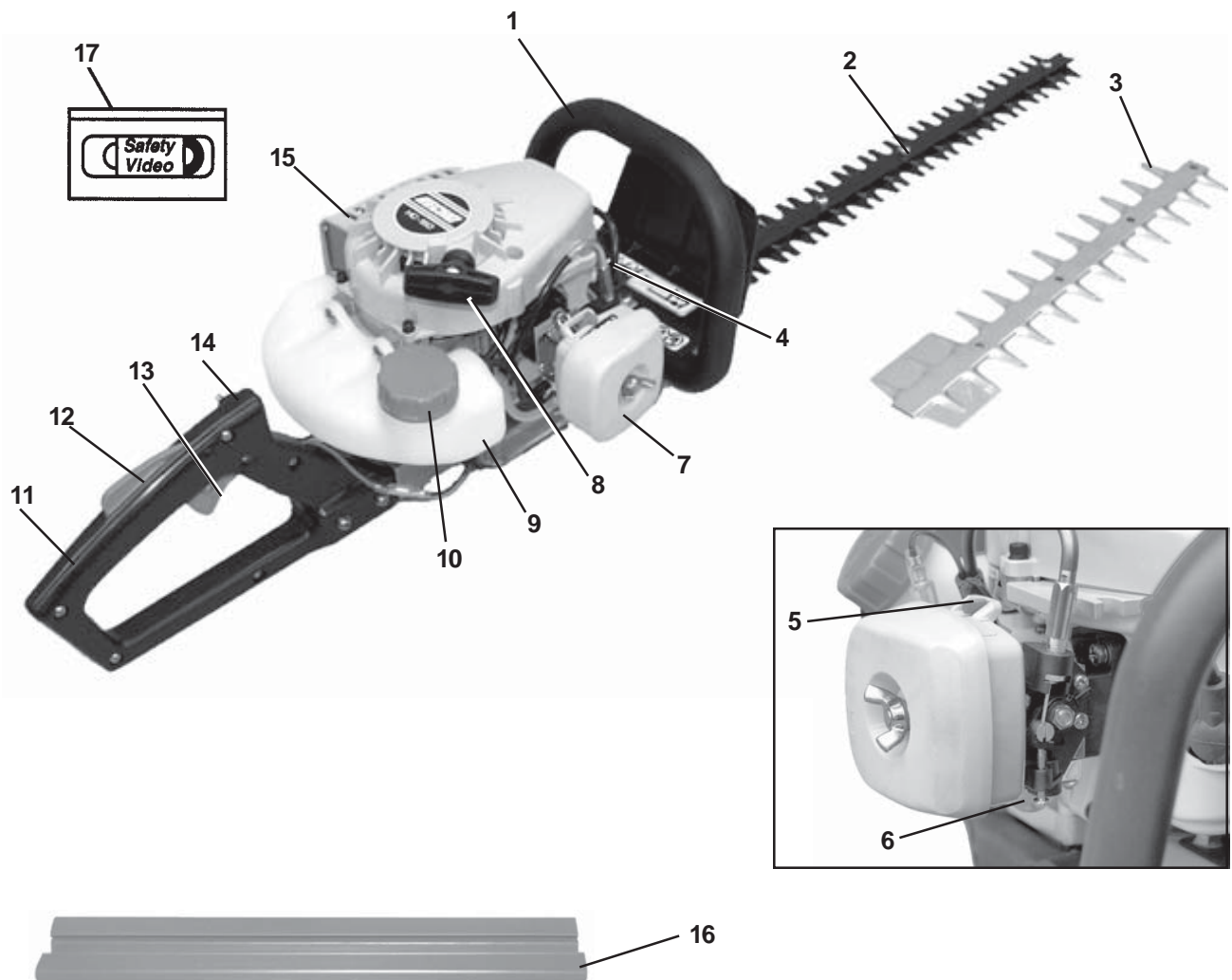
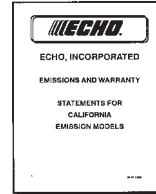
- 1 - Hedge Clipper Assembly
- 1 - Operator's Manual
- 1 - Safety Manual
- 1 - Warranty Statement
- 1 - Warranty Registration Card
- 1 - T-Wrench 13 x 19
- 1 - Blade Stiffener
- 4 - Blade Locknuts
- 4 - Stiffener Washers
- 1 - Echo Power Blend™ 2-stroke oil sample
- 1 - Blade Cover



1. **FRONT HANDLE / GUARD** - Comfortable, textured finish provides anti-slip grip for front hand. Guard protects hand from the blades. Warning decals are located on guard.
2. **BLADES** - Double reciprocating blades mounted to a blade support bar. The blades are double sided, capable of cutting on either side.
3. **BLADE STIFFENER** - Attaches to top of blades and guides material being cut into blades.
4. **SPARK PLUG** - Provides spark to ignite fuel mixture.
5. **CHOKE** - The choke control lever is located on the front of the air cleaner case. Move choke lever to "COLD START" () to close the choke for Cold Starting. Move choke lever to "RUN" () position to open choke.
6. **PRIMER BULB** - Pumping primer bulb before starting engine draws fresh fuel from the fuel tank priming the carburetor for starting. Pump primer bulb until fuel is visible and flows freely in the clear fuel tank return line. Pump bulb an additional 4 or 5 times.
7. **AIR CLEANER** - Contains replaceable filter element.
8. **RECOIL STARTER HANDLE** - Pull handle slowly until recoil starter engages, then quickly and firmly. **DO NOT** pull rope all the way out or allow the handle to snap back, damage to the starter will occur.
9. **FUEL TANK** - Contains fuel and fuel filter.
10. **FUEL TANK CAP** - Covers and seals fuel tank opening.
11. **REAR HANDLE** - Contains Stop Switch, Throttle Lockout and Throttle Trigger.
12. **THROTTLE TRIGGER LOCKOUT** - This lever must be depressed before Throttle Trigger can be activated.
13. **THROTTLE TRIGGER** - Spring loaded to return to idle when released. Trigger Lockout must be depressed fully before Throttle Trigger will move. During acceleration, depress gradually for best operating technique.
14. **STOP SWITCH** - "TOGGLE SWITCH" located on the left side of the rear handle. Move switch UP to RUN, DOWN to STOP.
15. **SPARK ARRESTOR - CATALYTIC MUFFLER / MUFFLER** - The muffler or catalytic muffler controls exhaust noise and emission. The spark arrestor screen prevents hot, glowing particles of carbon from leaving the muffler. Keep exhaust area clear of flammable debris.
16. **BLADE COVER** - Used to cover blades during transportation or storage. Remove blade cover before using unit.
17. **SAFETY VIDEO** - (Not included with unit) P/N 99922202800 English version only is available at a cost of \$5.00 from ECHO, INC. or any authorized ECHO dealer. The video overviews safety precautions and proper operating techniques and is supplemental to the Safety Manual. Read and understand the Safety Manual for complete information on safe operation.

SPECIFICATIONS

MODEL	HC-150
Length	1,040mm (41.0 in.)
Width	240mm (9.45 in.)
Height	200mm (7.87 in.)
Weight, dry	4.8kg (10.7 lb.)
Type of Engine	Air cooled, two-stroke, single cylinder, gasoline engine
Displacement	21.2 cc (1.29 cu.in.)
Bore	32.2 mm (1.27 in.)
Stroke	26.0 mm (1.02 in.)
Exhaust System	Spark Arrestor Muffler
Carburetor	Zama w/purge
Ignition System	Flywheel Magneto, Capacitor discharge ignition
Spark Plug	BPMR-8Y (Gap 0.65 mm (0.026 in.))
Fuel	Mixed Fuel - gasoline and oil
Fuel/Oil Ratio	50:1 two-stroke air cooled engine oil
Gasoline	89 Octane unleaded. DO NOT use fuel containing methyl alcohol, more than 10% ethyl alcohol or 15% MTBE.
Oil	Power Blend™ Premium Universal 2-Stroke Oil
Fuel Tank Capacity	0.5 lit. (16.9 fl. oz)
Starter System	Automatic Recoil Starter
Clutch	Centrifugal Type
Gear Case Ratio	5.88:1
Cutter	Double Reciprocating Blade, Double Edge
Length	490 mm (19.3 in.)
Pitch	35 mm (1.38 in.)
Height	21 mm (0.83 in.)
Idle Speed (RPM)	2,400 - 3,200
Wide Open Throttle (RPM)	10,000 - 11,000

IMPORTANT

This spark ignition system complies with Canadian ICES-002

ASSEMBLY

NOTE

For normal cutting, Echo strongly recommends the blade stiffener be installed. In extreme conditions, such as commercial cutting, or when cutting thick and/or dense branches, efficiency may be increased by trimming without the blade stiffener.

Tools required: (2) 10 mm Wrenches

Parts Required: Blade Stiffener, Blade Lock Nuts (P/N 43302206460), Washers

WARNING DANGER

Hedge Clipper blades are very sharp. Wear gloves to protect hands.

IMPORTANT

Follow blade bolt adjustment instructions exactly. Failure to do so could result in damage to blades or gearbox.

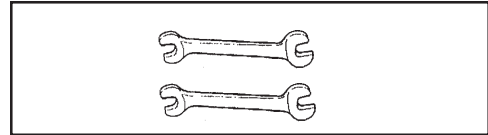

INSTALL BLADE STIFFENER

1. Disconnect spark plug wire.
2. Remove first four blade locknuts (A) closest to handle. Do not remove blade bolts.
3. Tighten blade bolts (B) until snug, then loosen ½ turn.
4. Install blade stiffener. Secure with washers and new locknuts (A). Do not allow blade bolts to turn.

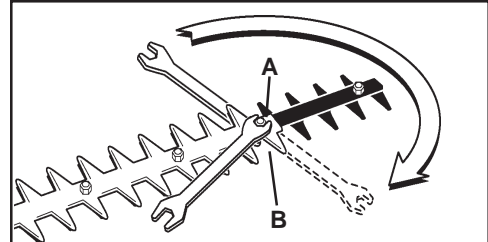

NOTE

Use new locknuts every time blade stiffener is installed.

BLADE STIFFENER REMOVAL

1. Disconnect spark plug wire.
2. Remove blade stiffener locknuts (A). Do not remove blade bolts.
3. Remove blade stiffener
4. Tighten blade bolts (B) until snug, then loosen ½ turn.
5. Secure blades with new locknuts (A). Do not allow blade bolts to turn.

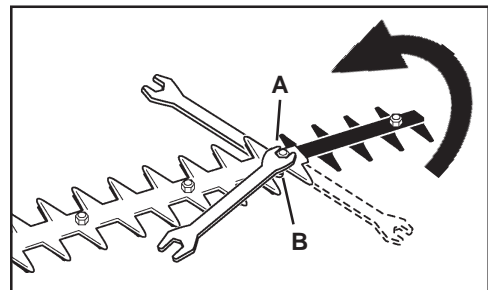

PRE-OPERATION

FUEL

Fuel Requirements

Gasoline - Use 89 Octane [R+M/2] (mid grade or higher) gasoline known to be good quality. Gasoline may contain up to 15% MTBE (methyl tertiary-butyl ether). Gasohol containing methyl (wood) alcohol is **NOT** approved.

Two Stroke Oil - A two-stroke engine oil meeting ISO-L-EGD (ISO/CD 13738) and J.A.S.O. **FC** Standards must be used. Echo brand premium Power Blend™ Universal 2-Stroke Oil meets these standards. Engine problems due to inadequate lubrication caused by failure to use an ISO-L-EGD and J.A.S.O. **FC** certified oil, such as Echo premium Power Blend™, will void the two-stroke engine warranty. (Emission related parts only are covered for two years, regardless of two-stroke oil used, per the statement listed in the Emission Defect Warranty Explanation.)

IMPORTANT

Echo premium Power Blend™ Universal 2-Stroke Oil may be mixed at 50:1 ratio for application in all Echo engines sold in the past regardless of ratio specified in those manuals.

Mixing Instructions

1. Fill an approved fuel container with half of the required amount of gasoline.
2. Add the proper amount of 2-stroke oil to gasoline.
3. Close container and shake to mix oil with gasoline.
4. Add remaining gasoline and remix.
5. Install fuel container cap and wipe any spilled fuel from container and surrounding area.

Handling Fuel

WARNING **DANGER**

Fuel is **VERY** flammable. Use extreme care when mixing, storing or handling or serious personal injury may result.

- Use an approved fuel container.
- **DO NOT** smoke near fuel.
- **DO NOT** allow flames or sparks near fuel.
- Fuel tanks/cans may be under pressure. Always loosen fuel caps slowly allowing pressure to equalize.
- **NEVER** refuel a unit when the engine is **HOT!**
- **NEVER** refuel a unit with the engine running.
- **DO NOT** fill fuel tanks indoors. **ALWAYS** fill fuel tanks outdoors over bare ground.
- Securely tighten fuel cap after refueling.
- Inspect for fuel leakage. If fuel leakage is found, do not start or operate unit until leakage is repaired.

IMPORTANT

Spilled fuel is a leading cause of hydrocarbon emissions. Some states may require the use of automatic fuel shut-off containers to reduce fuel spillage. Contact your ECHO dealer for ordering information.

After Refueling

- Wipe any spilled fuel from the unit.
- Move at least 3 m (10 ft.) from refueling location before starting the engine.

After use

- **DO NOT** store a unit with fuel in its tank. Leaks can occur. Return unused fuel to an approved fuel storage container.

Storage - Fuel storage laws vary by locality. Contact your local government for the laws affecting your area. As a precaution, store fuel in an approved, airtight container. Store in a well-ventilated, unoccupied building, away from sparks and flames. Do not store fuel longer than 30 days.

IMPORTANT

Stored fuel ages. Do not mix more fuel than you expect to use in thirty (30) days, ninety (90) days when a fuel stabilizer is added.

IMPORTANT

Stored two-stroke fuel may separate. **ALWAYS** shake fuel container thoroughly before each use.

OPERATION

NOTE

The blade cover is used for transportation and storage. Remove blade cover before using the unit.

STARTING COLD ENGINE

1. *Stop Switch*

Move stop switch (A) away from the STOP position.

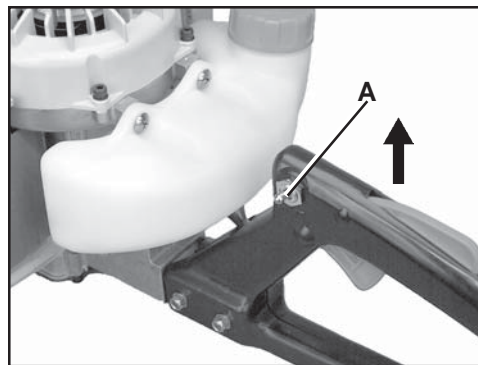

2. *Choke*

Move choke (B) to the Cold Start (|←|) (CLOSED) position.

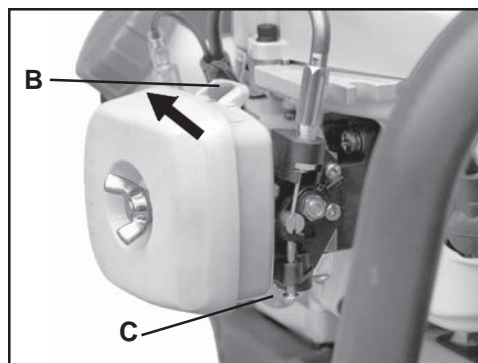

3. *Primer*

Pump primer bulb (C) until fuel is visible and flows freely in the clear fuel tank return line. Pump bulb an additional 4 or 5 times.

4. *Recoil Starter*

Lay the unit on a flat, clear area. Grip the front handle securely with one hand, and pull the recoil starter handle (D) until engine fires (or 5 pulls maximum).

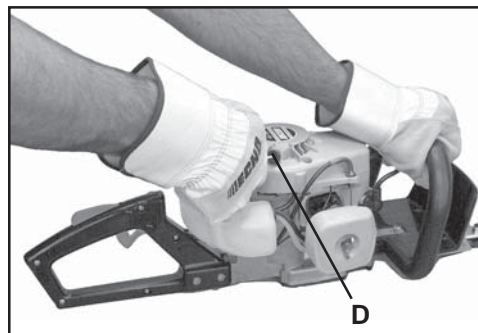

5. *Choke*

After engine fires or 5 pulls, move choke (B) to the RUN (|↑|) (OPEN) position. Restart engine if necessary and allow unit to warm up at idle for several minutes.

NOTE

If engine does not start with choke in "Run" position after 5 pulls, repeat instructions 2 - 5.

WARNING DANGER

The blades should not move at idle. If blades move, readjust carburetor according to "Carburetor Adjustment" instructions in this manual or see your ECHO Dealer, otherwise serious personal injury may result.

6. *Throttle Trigger*

After engine warm-up, grip the handle to depress the throttle trigger lockout, and gradually depress throttle trigger to increase engine RPM to operating speed.

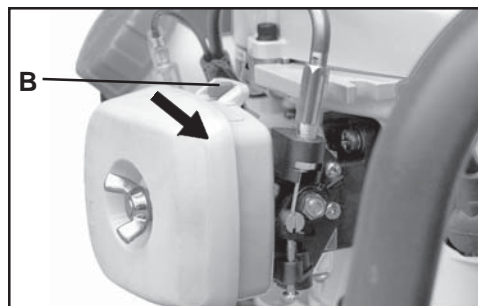

STARTING WARM ENGINE

The starting procedure is the same as Cold Start except DO NOT close the choke.

WARNING DANGER

The blades should not move at idle. If blades move, readjust carburetor according to "Carburetor Adjustment" instructions in this manual or see your ECHO Dealer, otherwise serious personal injury may result.

1. *Stop Switch*
Move stop switch (A) away from the STOP position.
2. *Primer*
Pump primer bulb (C) until fuel is visible and flows freely in the clear fuel tank return line. Pump bulb an additional 4 or 5 times.
3. *Recoil Starter*
Place the unit on a flat, clear area. Grip the front handle securely with one hand, and pull the recoil starter handle (D) until engine starts.

NOTE

If engine does not start after 5 pulls, use Cold Start Procedure.

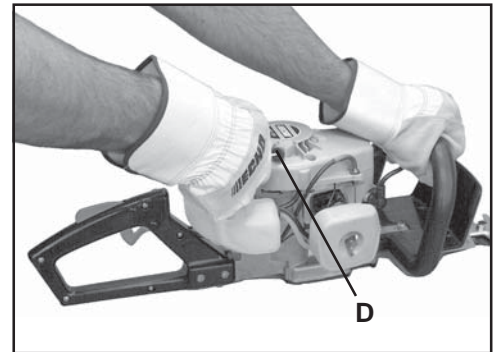
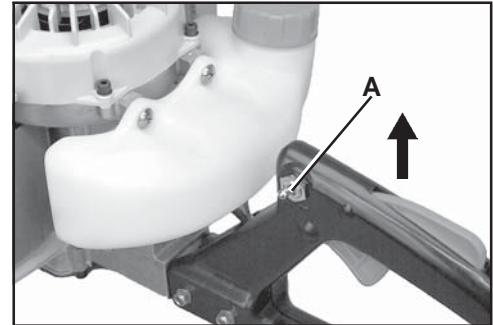

STOPPING ENGINE

1. *Throttle*
Release throttle and allow engine to return to idle before shutting off engine.
2. *Stop Switch*
Move stop switch (A) to STOP position.

WARNING DANGER

If engine does not stop when stop switch is moved to STOP position, close choke - COLD START position - to stall engine. Have your ECHO dealer repair stop switch before using hedge clipper again.

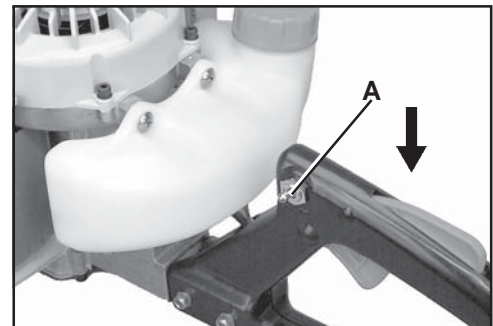

HEDGE TRIMMING

NOTE

This unit is designed to cut shrubs and hedges with branches no larger than 6 mm (1/4 in.) in diameter.

1. Hold trimmer firmly and squeeze throttle trigger to accelerate engine.
2. Tilt trimmer so cutting teeth are angled slightly toward the hedge or shrub and proceed to cut.

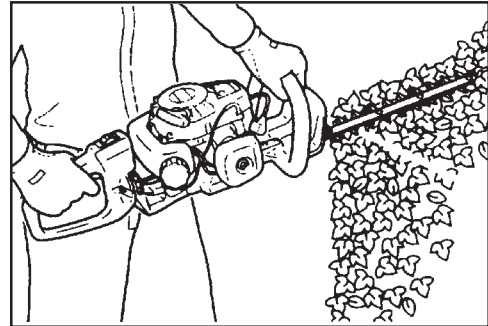

WARNING DANGER

Never remove hands from unit when blades are moving.

WARNING DANGER

The engine continues running even when the blades have stopped due to an obstruction. If this occurs, stop the engine, disconnect ignition cable and remove the obstruction.

MAINTENANCE

Your ECHO unit is designed to provide many hours of trouble free service. Regular scheduled maintenance will help your unit achieve that goal. If you are unsure or are not equipped with the necessary tools, you may want to take your unit to an ECHO Service Dealer for maintenance. To help you decide whether you want to DO-IT-YOURSELF or have the ECHO Dealer do it, each maintenance task has been graded. If task is not listed, see your ECHO Dealer for repairs.

SKILL LEVELS

- Level 1**= Easy to do. Most required tools come with unit.
- Level 2**= Moderate difficulty. Some specialized tools may be required.
- Level 3**= Experience required. Specialized tools are required. Echo recommends that the unit be returned to your ECHO dealer for service.

ECHO offers **REPOWER™** Maintenance Kits and Parts to make your maintenance job easier. Just below each task heading are listed the various part numbers required for that task. See your ECHO dealer for these parts.

MAINTENANCE INTERVALS

COMPONENT/ SYSTEM	MAINTENANCE PROCEDURE	REQ'D SKILL LEVEL	DAILY OR BEFORE USE	EVERY REFUEL	3 MONTHS OR 90 HOURS	6 MONTHS OR 270 HOURS	YEARLY 600 HOURS
Recommended Echo Dealer Maintenance Procedures							
Carburetor	Inspect/Clean/Replace	3				I / C (1)	R (1)
Cylinder Exhaust Port	Inspect/Clean/Decarbon	3			I / C		
Sharpen Blades	Inspect/Clean	3	I (3)				
Do-It-Yourself Maintenance Procedures							
Air Filter	Inspect/Clean/Replace	1	I / C		R*		
Choke	Inspect/Clean	2	I / C				
Fuel Filter	Inspect/Replace	1			I		R *
Fuel Line	Inspect/Replace	1	I *	I			
Cooling System	Inspect/Clean	2	I / C				
Muffler Spark Arrestor	Inspect/Replace	2			I *		
Gear Housing	Grease	2	I (2)				
Blades	Inspect/Clean	1	I / C (3)				
Recoil Starter Rope	Inspect/Clean	1	I / C *				
Fuel Leaks	Inspect	1	I *	I *			
Spark Plug	Inspect/Clean	2			I / C	R *	
Screws/Nuts/Bolts	Inspect/Tighten/Replace	1	I / R *				

MAINTENANCE PROCEDURE LETTER CODES: I = INSPECT, R = REPLACE, C = CLEAN

IMPORTANT NOTE - Time intervals shown are maximum. Actual use and your experience will determine the frequency of required maintenance.

MAINTENANCE PROCEDURE NOTES:

(1) Replacement will be required for Commercial use after 600 hours. For Consumer use, cleaning every 6 months is required.

(2) Apply ECHO[®] LUBE[™] every 15 - 25 hours of use.

(3) Inspect blade and clean and sharpen as needed. Lubricate blades periodically during use.

* All recommendations to replace are based on the finding of damage or wear during inspection.

AIR FILTER

Level 1.

Tools required: 25 or 50 mm (1 or 2 in.) cleaning brush

Parts required: 90008REPOWER™ AIR & FUEL FILTER KIT

1. Close choke (Cold Start Position []). This prevents dirt from entering the carburetor throat when the air filter is removed. Brush accumulated dirt from the air cleaner area.
2. Remove the air cleaner cover. Clean and inspect the element for damage. If element is fuel soaked and very dirty, replace.
3. If element can be cleaned and reused, be certain it:
 - still fits the cavity in the air cleaner cover.
 - is installed with the original side out.

NOTE

Carburetor adjustment may be needed after air filter cleaning/replacement.

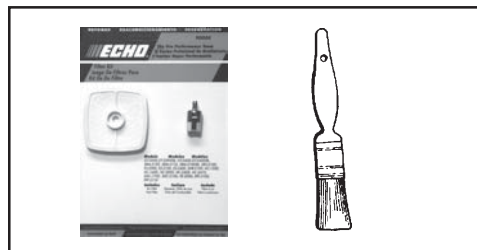

FUEL FILTER

Level 1.

Tools required: 200-250 mm (8-10 in.) length of wire with one end bent into a hook, clean rag, funnel, and an approved fuel container

Parts required: 90008REPOWER™ AIR & FUEL FILTER KIT

WARNING DANGER

Fuel is **VERY** flammable. Use extreme care when mixing, storing or handling.

1. Use a clean rag to remove loose dirt from around fuel cap and empty fuel tank.
2. Use the “fuel line hook” to pull the fuel line and filter from the tank.
3. Remove the filter from the line and install the new filter.

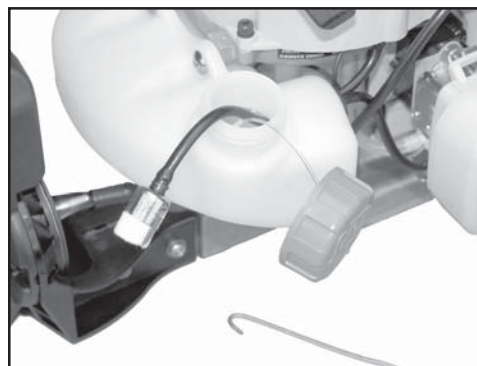

SPARK PLUG

Level 2.

Tools required: T-wrench, Feeler gauge, Soft metal brush

Parts required: Spark Plug, NGK BPMR-8YP/NA425000000

1. Remove spark plug and check for fouling, worn and rounded center electrode.
2. Clean the plug or replace with a new one. DO NOT sand blast to clean. Remaining sand will damage engine.
3. Adjust spark plug gap by bending outer electrode.
4. Tighten spark plug to 145-155 kg/cm (125-135 in. lb.).

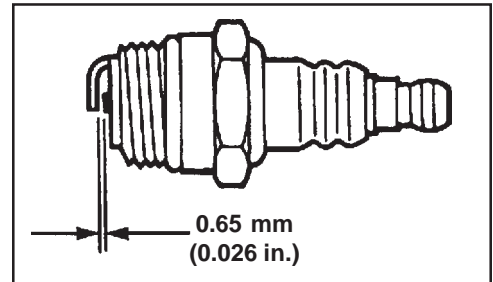
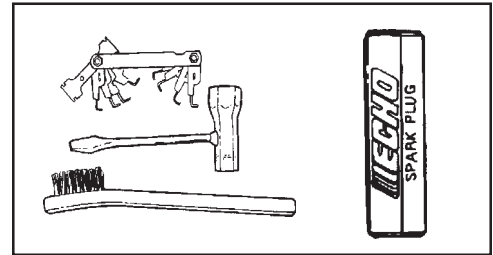

COOLING SYSTEM CLEANING

Level 2.

Tools required: 3 mm Hex wrench, 25 or 50 mm (1 or 2 in.) cleaning brush

Parts required: None if you are careful.

IMPORTANT

To maintain proper engine operating temperatures, cooling air must pass freely through the cylinder fin area. This flow of air carries combustion heat away from the engine.

Overheating and engine seizure can occur when:

- Air intakes in the crankcase are blocked, preventing cooling air from reaching the cylinder.
- Dust and grass build up on the outside of the cylinder. This build up insulates the engine and prevents the heat from leaving.

Removal of crankcase cooling passage blockages or cleaning of cooling fins is considered "Normal Maintenance." Any failure attributed to lack of maintenance is not warranted.

1. Remove spark plug lead and spark plug.
2. Remove (4) starter cover hex socket bolts and starter.

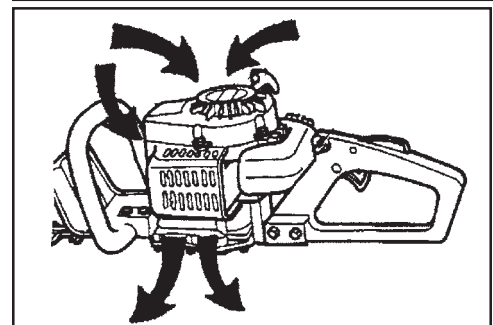
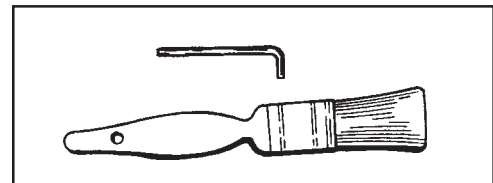

3. Remove bottom right (A) and bottom left (B) hex socket bolts from cylinder cover.
4. Remove heat shield bolt (C) from the muffler cover.
5. Carefully pull cylinder cover forward disengaging muffler gasket tabs and ignition lead and lay aside.
6. Loosely install spark plug to keep debris out of the cylinder. Use brush to remove dirt from cylinder fins.

IMPORTANT

DO NOT use a metal scraper to remove dirt from the cylinder fins.

7. Assemble components in reverse order.

NOTE

When installing the cylinder cover, be certain the muffler gasket tabs (D) are locked into the muffler grill slots and the stop switch lead is seated in the rubber grommet.

Cylinder Exhaust Port

Level 3.

IMPORTANT

The cylinder exhaust port must be inspected and cleaned of excess carbon every 3 months or 90 hours of operation in order to maintain this engine within the emissions durability period. ECHO strongly recommends that you return your unit to your ECHO dealer for this important maintenance service.

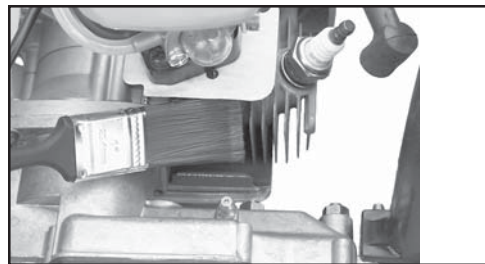
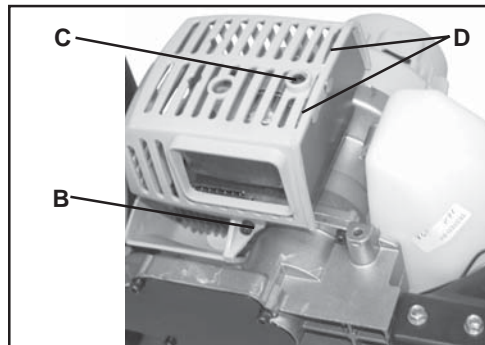
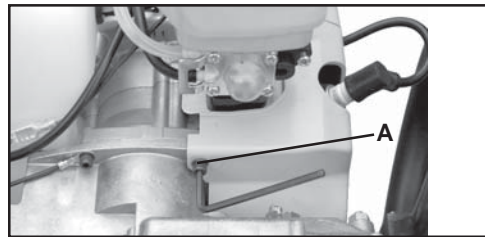

EXHAUST SYSTEM

Spark Arrestor Screen

Level 2.

Tools required: 3 mm Hex wrench, Cross Head Screwdriver, Soft metal brush

Parts required: Screen P/N 14586240630, Gasket P/N 14586642031

1. Remove engine cover. See “Cleaning Cooling System” for step by step instructions.
2. Place piston at Top Dead Center (TDC) to prevent carbon/dirt from entering cylinder.
3. Remove exhaust guide (A), gasket (B), and screen (C) from muffler body.
4. Clean carbon deposits from muffler components.

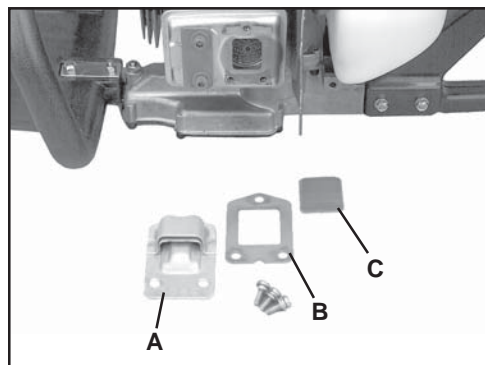
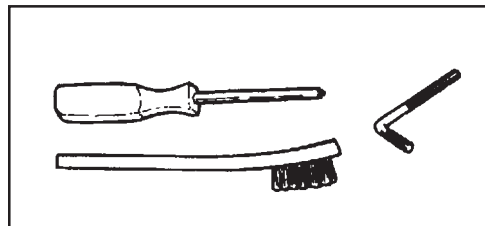

5. Replace screen if it is cracked, plugged or has holes burned through.
6. Assemble components in reverse order.

NOTE

When installing the cylinder cover, be certain the muffler gasket tabs (D) are locked into the muffler grill slots and the stop switch lead is seated in the rubber grommet.

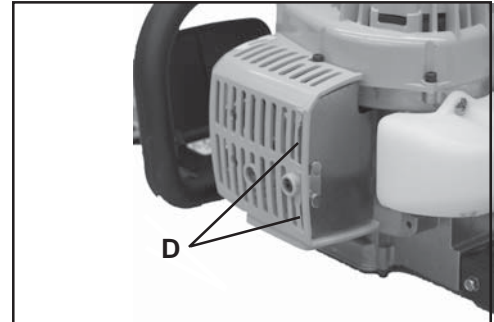

CARBURETOR ADJUSTMENT

Engine Break-In

New engines must be operated a minimum duration of two tanks of fuel break-in before carburetor adjustments can be made. During the break-in period your engine performance will increase and exhaust emissions will stabilize. Idle speed can be adjusted as required.

High Altitude Adjustment

High altitude adjustment is not required for proper operation of this engine.

Level 2.

Tools required: Screwdriver, Tachometer (ECHOP/N99051130017).

Parts required: None.

NOTE

Every unit is run at the factory and the carburetor is set in compliance with emission regulations. This carburetor does not have acceleration and high-speed adjustment needles.

1. Check idle speed and reset if necessary. If a tachometer is available, idle speed screw (A) should be set to the specifications found on page 9 "Specifications" of this manual. Turn idle screw (A) clockwise to increase idle speed; counter clockwise to decrease idle speed.

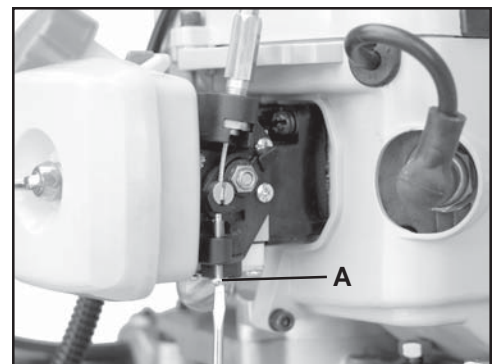
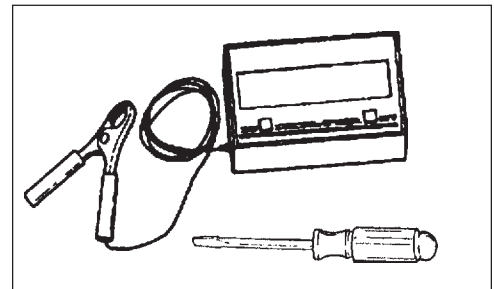

WARNING **DANGER**

When carburetor adjustment is completed, the cutting attachment should not move at idle, otherwise serious personal injury may result.

LUBRICATION

Blades

Level 1.

Tools required: Clean rag, 25 or 50 mm (1 or 2 in.) cleaning brush

Parts required: 20W Engine Oil (lubrication), 50-50 mixture of kerosene and 20W oil (cleaning).

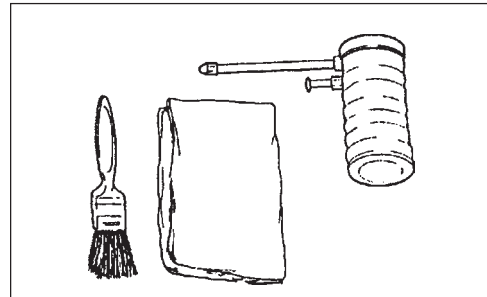

WARNING DANGER

Hedge Clipper Blades are very sharp. Wear gloves to protect hands.

1. Disconnect spark plug wire from spark plug.
2. Brush loose debris from blade and coat both sides of blade with the 50-50 cleaning mixture.
3. Allow cleaning mixture to soften the remaining gummy residue then wipe it from the blade.
4. Apply clean oil to the entire length of the blade. Be certain the blade bolts are lubricated.
5. Wipe excess oil from the blade before putting the unit back in service.

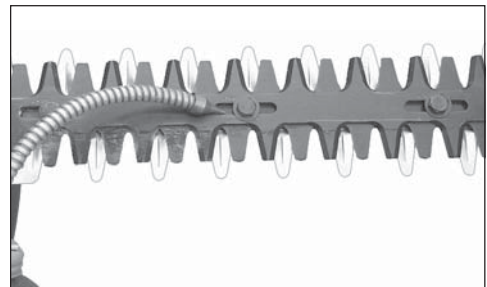
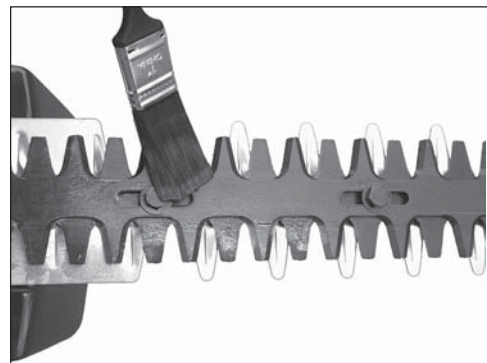

Gear Box Assembly

Level 1.

Tools required: Grease Gun, Clean rag

Parts required: ECHO® LUBE™ 14 oz. (P/N 91015) or Lithium Based Grease.

1. Clean dirt from the grease fitting (A).
2. Carefully pump grease into fitting (A). **DO NOT** force grease. Too much pressure will force grease past seals and cause damage. Apply 1-2 pumps of grease every 15-25 hours of operation.
3. Wipe excess grease from around grease fitting.

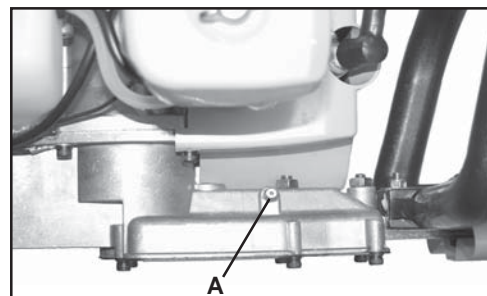

SHARPENING BLADES

Level 3.

Tools required: (2) 10 mm Wrenches, Flat file, Screwdriver

Parts required: None

WARNING DANGER

Hedge Clipper Blades are very sharp. Wear gloves to protect hands.

1. Disconnect spark plug wire.
2. Remove blade stiffener (see “Blade Stiffener Install/ Remove instructions”).
3. Slide blades to midpoint cutting position using slots (A) on bottom of blade. Do not pry against cutting edges.
4. File each edge carefully. Follow the original shape of the blade.

IMPORTANT

If a power grinder is used **DO NOT** allow blade to over heat.

5. Install blade stiffener (see “Blade Stiffener Install/ Remove instructions”).
6. Lubricate blades (see “Lubrication instructions”).

IMPORTANT

Blades should only be removed and reinstalled by an Authorized ECHO Servicing Dealer, otherwise premature wear or internal damage may occur.

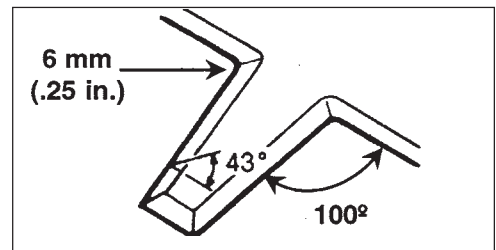
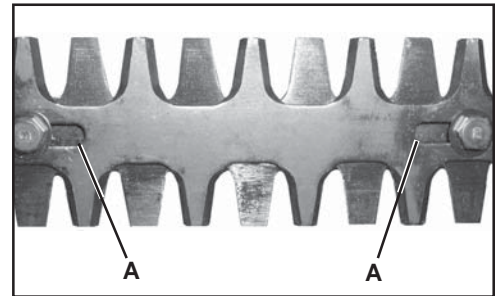
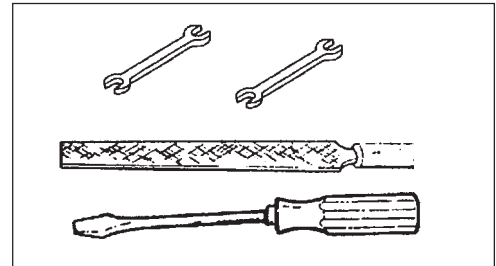

TROUBLESHOOTING

ENGINE PROBLEM TROUBLESHOOTING CHART

Problem	Check	Status	Cause	Remedy
Engine cranks - starts hard/ doesn't start	Fuel at carburetor	No fuel at carburetor	Fuel strainer clogged Fuel line clogged Carburetor	Clean or replace Clean or replace See your Echo dealer
	Fuel at cylinder	No fuel at cylinder	Carburetor	See your Echo dealer
		Muffler wet with fuel	Fuel Mixture too rich	Open choke Clean/replace air filter Adjust carburetor See your Echo dealer
	Spark at end of plug wire	No spark	Stop switch off Electrical problem Interlock switch	Turn switch to ON See your Echo dealer See your Echo dealer
	Spark at plug	No spark	Spark gap incorrect Covered with carbon Fouled with fuel Plug defective	Adjust to .65mm (0.026 in.) Clean or replace Clean or replace Replace plug
Engine runs, but dies or does not accelerate properly	Air filter	Air filter dirty	Normal wear	Clean or replace
	Fuel filter	Fuel filter dirty	Contaminants/residues in fuel	Replace
	Fuel vent	Fuel vent plugged	Contaminants/residues in fuel	Clean or replace
	Spark Plug	Plug dirty/worn	Normal wear	Clean and adjust or replace
	Carburetor	Improper adjustment	Vibration	Adjust
	Cooling System	Cooling system dirty/plugged	Extended operation in dirty/dusty locations	Clean
	Spark Arrestor Screen	Spark arrestor screen plugged	Normal wear	Replace
Engine does not crank	N/A	N/A	Internal engine problem	See your Echo dealer

WARNING  **DANGER**

Fuel vapors are **extremely** flammable and may cause fire and/or explosion. **Never** test for ignition spark by grounding spark plug against cylinder; otherwise serious personal injury may result.

STORAGE

WARNING  **DANGER**

During operation the muffler or catalytic muffler and surrounding cover become hot. Always keep exhaust area clear of flammable debris during transportation or when storing, otherwise serious personal injury may result.

Long Term Storage (over 30 days)

Do not store your unit for a prolonged period of time (30 days or longer) without performing protective storage maintenance which includes the following:

1. Store unit in a dry, dust free place, out of the reach of children.

WARNING  **DANGER**

Do not store in enclosure where fuel fumes may accumulate or reach an open flame or spark, otherwise serious personal injury may result.

- | | |
|---|--|
| <ol style="list-style-type: none"> 2. Place the stop switch in the "OFF" position. 3. Remove accumulation of grease, oil, dirt and debris from exterior of unit. 4. Perform all periodic lubrication and services that are required. 5. Apply clean oil to the entire length of the blade. Be certain the blade bolts are lubricated. 6. Install blade cover on blades. 7. Tighten all the screws and nuts. 8. Drain the fuel tank completely and pull the recoil starter handle several times to remove fuel from the carburetor. | <ol style="list-style-type: none"> 9. Remove the spark plug and pour 7cc (1/4 oz.) of fresh, clean, two-stroke engine oil into the cylinder through the spark plug hole. <ol style="list-style-type: none"> A. Place a clean cloth over the spark plug hole. B. Pull the recoil starter handle 2-3 times to distribute the oil inside the engine. C. Observe the piston location through the spark plug hole. Pull the recoil handle slowly until the piston reaches the top of its travel and leave it there. 10. Install the spark plug (do not connect ignition cable). |
|---|--|

IMPORTANT

Always store and transport hedge clippers in a stable, horizontal position. Support gear case and cutting blades to prevent excessive flexing, which may cause damage to these components. Always install blade cover when transporting or storing unit.

SERVICING INFORMATION

PARTS

Genuine ECHO Parts and ECHO REPOWER™ Parts and Assemblies for your ECHO products are available only from an Authorized ECHO Dealer. When you do need to buy parts **always** have the Model Number and Serial Number of the unit with you. You can find these numbers on the engine housing. For future reference, write them in the space provided below.

Model Number _____ Serial Number _____

SERVICE

An Authorized ECHO Service Dealer must perform Service of this product during the warranty period. For the name and address of the Authorized ECHO Service Dealer nearest you, ask your retailer or call: 1-800-432-ECHO (3246). Dealer information is also available on our Web Site. When presenting your unit for Warranty service/repairs, proof of purchase is required.

ECHO CONSUMER PRODUCT SUPPORT

If you require assistance or have questions concerning the application, operation or maintenance of this product you may call the ECHO Consumer Product Support Department at 1-800-673-1558 from 8:30 am to 4:30 pm (Central Standard Time) Monday through Friday. Before calling, please know the model and serial number of your unit to help your Consumer Product Support Representative.

WARRANTY REGISTRATION

You may register your Echo equipment using the warranty registration card or register on-line at www.echo-usa.com. Registering provides a direct link between you and Echo if we find it necessary to contact you.

ADDITIONAL OR REPLACEMENT MANUALS

Safety Manuals in English/Spanish or English/French are available, free of charge, from your ECHO dealer or at www.echo-usa.com.

Operator's and Parts Manuals are available by:

- Downloading free from www.echo-usa.com
- Purchasing from your Echo Dealer.
- Manuals are available by sending a written request stating the model number and serial number of your Echo unit, part number of the manual, your name and address, and mail to the address below.

Safety Videos are available from your Echo dealer. A \$5.00 shipping charge will be required for each video.

Available Parts Catalog

HC-150

Serial Number 07001001 - 07999999

Part Number 99922203278

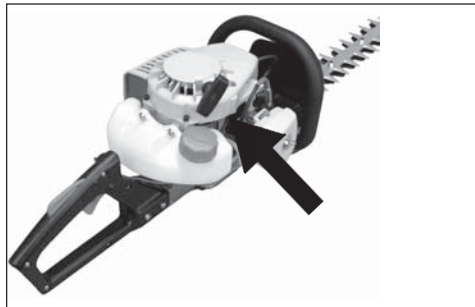

DEALER?

Call

1-800-432-ECHO

or

www.echo-usa.com

CONSUMER PRODUCT SUPPORT

1-800-673-1558

8:30 - 4:30 Mon - Fri C.S.T.



ECHO®

ECHO, INCORPORATED

400 OAKWOOD ROAD
LAKE ZURICH, IL 60047

www.echo-usa.com