

# marantz®

Slim Line Plasma Monitor

## PD4298HD

**USER MANUAL  
MANUEL UTILISATEUR  
MANUAL DE USUARIO**

---

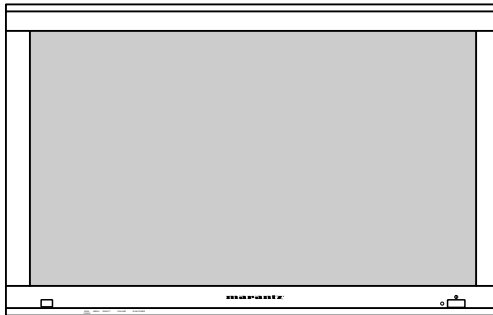

**READ THE INSTRUCTIONS INSIDE CAREFULLY.  
KEEP THIS USER MANUAL FOR FUTURE REFERENCE.**

For future reference, record the serial number of your monitor.

**SERIAL NO.** \_\_\_\_\_

The serial number is located on the rear of the monitor.

**NOTE:**

The information in this manual is subject to change without notice. The manufacturer assumes no responsibility for any errors that may appear in this manual.

**TRADEMARK ACKNOWLEDGEMENT**

VGA and XGA are registered trademarks of International Business Machines Corporation.

APPLE and Macintosh are registered trademarks of Apple Computer, Inc.

VESA is a trademark of a nonprofit organization, Video Electronics Standard Association.

All brand or product names are trademarks or registered trademarks of their respective holders.

---

**REMARQUE:**

Les particularités de l'écran couleur à plasma sont les suivantes.

Les informations contenues dans ce manuel peuvent être modifiées sans préavis. Le constructeur n'accepte aucune responsabilité pour les erreurs qui peuvent éventuellement apparaître dans ce manuel.

**MARQUES DÉPOSÉES**

VGA et XGA sont des marques déposées d'International Business Machines Corporation.

APPLE et Macintosh sont des marques déposées d'Apple Computer Inc.

VESA est une marque déposée d'une organisation sans but lucratif, La Video Electronics Standard Association.

Toutes les marques ou noms de produit sont des marques de commerce ou des marques déposées de leur dépositaire respectif.

---

**NOTA:**

La información contenida en este manual está sujeta a cambios sin previo aviso. El fabricante no será responsable de los errores que puedan aparecer en este manual.

**RECONOCIMIENTO DE MARCAS**

VGA y XGA son marcas registradas de International Business Machines Corporation.

APPLE y Macintosh son marcas registradas de Apple Computer, Inc.

VESA es una marca comercial de una organización sin fines de lucro, Video Electronics Standard Association.

Todas las marcas y nombres de productos son marcas comerciales o registradas de sus respectivos titulares.

---

# SAFETY GUIDELINES

This monitor is designed to be safe to use. However, due to high voltage of about 400 V, fire or serious injury may occur unless you use this monitor in correct way. You are strongly suggested to follow the instruction shown below in order to avoid such injury.



**Keep the safety guideline**

**Do not use the monitor if it fails**

**If you find something unusual ,**

- ☆ If smoke comes out,
- ☆ If there is a strange smell,
- ☆ If water enters the case,
- ☆ If you drop the monitor or damage the cabinet,



- ① Turn off the monitor
- ② Disconnect the power plug from the mains
- ③ Request for repair

Warning and Caution are indicated in this guide and monitor itself.



Fire or electric shock may cause death or serious injury unless you follow the instruction.



Electric shock or other accidents may cause serious injury or damage of your properties.

# SAFETY GUIDELINES(continued)



Fire or electric shock may cause death or serious injury unless you follow the instruction below.

● **If something smells strange or smoke comes from the monitor:**

Turn off the monitor and disconnect the power plug from the mains immediately.

Contact service center after confirming that the smoking has stopped.

If you continue to operate the monitor with such abnormal condition, it may cause fire or you may receive an electric shock.

● **Do not drop water or a foreign substance on to the monitor.**

If you drop water or a foreign substance on to the monitor, it may cause fire or an electric shock.

If it happens turn off the monitor and disconnect the power plug from the mains and ask service center for instruction.

● **Do not put the monitor on an unstable place.**

If you put the monitor on an uneven or unstable place, it may fall down and you may be injured.

Put the monitor on a flat surface strong enough to take the weight.

● **Do not apply shock to the monitor.**

If no picture, glass broken, smoke or something is smelling after applying shock to the monitor, turn off the monitor and disconnect the power plug from the mains immediately. Then, call the service center.

If you continue to operate the monitor with such abnormal conditions, it may cause fire or you may receive an electric shock.

● **Do not disassemble or modify the monitor.**

There is high voltage portion inside of the monitor. Disassembling or modification of the monitor may cause fire or electric shock.

● **Do not use the monitor in wet environment.**

If you use the monitor in a wet place such as bath or shower room, it may cause fire or electric shock. Using the monitor beside a window when snowing or raining or by a seaside are not recommended.

● **Do not damage or modify the power cord.**

If you put something heavy on the power cord or pull, squeeze, heat the cord, it may be damaged and it may cause fire or electric shock.

If the power cord is damaged, call service center.



Fire or electric shock may cause death or serious injury unless you follow the instruction.

● **The enclosed power cord must be used!**

Failure to do so may cause electric shock hazard or fire hazard.

In **USA/Canada**, use a UL LISTED/CSA LABELLED or CERTIFIED power cord set meeting the following specifications :

Rating: min. 125V, 10A , Length: max. 3.0m , Type: SVT or SJT

Plug type: NEMA 5-15P figure, Parallel blade, Grounding type

In **Europe or 200V area**, a proper European standard approved power cord is to be used with this monitor.

For a rated current up to 6 A, a type not lighter than H05VV-F 3G 0.75 mm<sup>2</sup> or H05VVH2-F 3G 0.75 mm<sup>2</sup> must be used.

● **Use only the correct voltage power outlet with safety ground connection!**

100 - 120 V for USA, Canada, etc.

200 - 240 V for Europe, etc.

(This monitor will automatically adjust to the input voltage 100 - 120 / 200 - 240V.)

● **Be careful of power cord connection!**

Before inserting the plug of the power cord into a socket of the correct voltage, check that the connection portion of the power cord is clean (with no dust). Then, insert the plug of power cord into the socket firmly, otherwise it may cause electric shock or fire hazard.

● **Do not touch the power plug when lightning is close to you.**

You may receive an electric shock.

● **Do not touch the power plug with wet hands.**

You may receive an electric shock.

● **Do not obstruct a ventilation hole.**

If you obstruct a ventilation hole during the operation of the monitor or just after switching off the power, it may cause a fire or electric shock due to heating up the monitor.

- Do not put the monitor screen side up.
- Do not put the monitor on a shelf or in a cabinet.
- Do not put the monitor on a carpet or mattress.
- Do not cover the monitor with a cloth.

# SAFETY GUIDELINES(continued)



Electric shock or other accidents may cause serious injury or damage to your property.

ENGLISH

● **Disconnect the power plug from the mains when you move the monitor.**

Moving the monitor without disconnecting the power plug from the mains may damage the cord and cause a fire or electric shock. You are advised to move the monitor with two persons.

Handle with care when you move the monitor, particularly take care of glass screen.

● **When you disconnect the power plug.**

You have to grasp the power plug itself, do not pull the power cord.

If you pull the power cord, you may damage it and it may cause a fire or an electric shock.

Do not touch the power plug just after disconnecting it from the mains or you may receive electric shock.

● **Disconnect the power plug from the mains when you don't use the monitor for a long time.**

This is just for your safety.

● **Do not put the monitor in atmosphere with soot, steam, high humidity, and dust.**

It may cause a fire or electric shock.

● **Do not put the monitor in high temperature atmosphere.**

Do not put the monitor in the place exposed to the direct rays of the sun for a long period of time. Heat may cause a fire, transformation, or melting of the monitor.

● **Do not put things on the monitor.**

Do not put things on the monitor or give some shock to the monitor.

The monitor may fall down or drop from a desk. And it may cause injury.



You may have serious injury or your property may be damaged unless you follow the instruction below.

● **Do not bundle the power cord.**

It will be heated up or it may cause a fire.

■ **Caution for 200 - 240V operation only**

This equipment relies on the protective devices in the building installation for short - circuit and over - current protection. Refer to the following table for the suitable number and location of the protective devices which should be provided in the building installation.

**INFORMATIVE EXAMPLES OF PROTECTIVE DEVICES IN SINGLE - PHASE EQUIPMENT OR SUB - ASSEMBLIES**

	Protection against	Minimum number of fuses or circuit - breaker poles	Location
Case A: Equipment to be connected to POWER SYSTEMS with earthed neutral reliably identified, except for Case C below.	Earth faults	1	Phase conductor
	Overcurrent	1	Either of the two conductors
Case B: Equipment to be connected to any supply, including IT POWER SYSTEMS and supplies with reversible plugs, except for Case C below.	Earth faults	2	Both conductors
	Overcurrent	1	Either of the two conductors
Case C: Equipment to be connected to 3 - wire power systems with earthed neutral reliably identified.	Earth faults	2	Each phase conductor
	Overcurrent	2	Each phase conductor

Verify that the protective devices in the building installation meets the conditions in the table prior to installing the equipment.

■ **Remove the power cord for complete isolation!**

For complete isolation from the mains, remove the power cord from the monitor or from the wall socket.

# SAFETY GUIDELINES(continued)

## Precautions

### ● Installation environment

Do not obstruct a ventilation hole.

Do not put the monitor on carpet or blanket, or near a curtain which has a possibility of obstructing a ventilation hole of the monitor.

Do not put the monitor in the following places.

- ◆ Hot places such as near heater, place exposed to the direct rays of the sun.
- ◆ A place where the temperature is widely changing.
- ◆ Places with soot, dust or high humidity.
- ◆ Poor air ventilation place.
- ◆ Place near fire.
- ◆ A wet place such as bathroom, or shower room.
- ◆ Place where you can trip over it.
- ◆ Always vibrating or strongly vibrating places.
- ◆ Distorted or unstable places.

### ● How to view the monitor.

If you use the monitor in too dark a room, your eyes may become tired.

Please use it in a reasonably bright room.

Avoid direct rays of the sun to the screen in order to prevent eye fatigue.

Your eyes will get fatigued after viewing the monitor for long.

Relax your eyes by viewing away from the monitor from time to time.

Please watch the monitor in downward direction.

### ● Note on Afterimages (Burn-in)

The plasma monitor illuminates phosphor to display images. The phosphor has a finite illumination life. After extended periods of illumination, the brightness of the phosphor would be degraded to such extent that stationary images would burn into that part of the screen as grayed-out images.

Tips to prevent such burn-in are:

- Do not display images having sharp brightness differences or high-contrast images, such as monochrome characters and graphic patterns, for long.
- Do not leave stationary images appearing for long, but try to refresh them at appropriate intervals of time, or try to move them using screen saver function.



---

### ● How to clean the monitor.

Before cleaning the monitor, turn off the monitor and disconnect the power plug from the mains.

When cleaning the monitor, do not spray directly the screen or cabinet with cleaner. Use a clean, dust free, dry and soft cloth. If it is not enough, then use a cloth with non-alcoholic or non-ammoniac detergent.

Do not rub the surface of the screen with ball-point-pen or screw-driver etc.

### ● Precautions for the monitor

- Use the attached signal-cable when you connect the monitor with PC equipment. Do not use other signal-cables.
- Confirm the connector is fixed tightly when the signal cable is connected. Also confirm the screws on the connector are tightened.
- Plug the power cord of the monitor into a different socket from that for other equipment, such as Radio etc..
- Use a plug with ground terminal and make sure that it connects to the ground.

### ● Precautions for Radio

- Keep the monitor away from Radio.
- Adjust Radio antennas in order for the monitor not to receive interference.
- The antenna cable of Radio should be kept away from the monitor.
- Use a coaxial cable for antenna.

You can check if this monitor influences Radio receivers by turning off all other equipment other than the monitor.

If you can find a problem receiving Radio when using the monitor, check the instructions mentioned above.

### ● Precaution during transportation

Please pay attention when you transport this monitor because it is heavy.

Furthermore, use the specific carton box and its packaging materials when the monitor is transported.

# SAFETY GUIDELINES(continued)

ENGLISH

## ■ FCC (Federal Communications Commission) STATEMENT WARNING

For model PD4298HD

**WARNING:** This equipment has been tested and found to comply with the limits for a Class B digital device, pursuant to Part 15 of the FCC Rules. These limits are designed to provide reasonable protection against harmful interference in a residential installation. This equipment generates, uses, and can radiate radio frequency energy and, if not installed and used in accordance with the instructions, may cause harmful interference to radio communications. However, there is no guarantee that interference will not occur in a particular installation. If this equipment does cause harmful interference to radio or television reception, which can be determined by turning the equipment off and on, the user is encouraged to try to correct the interference by one or more of the following measures:

- Reorient or relocate the receiving antenna.
- Increase the separation between the equipment and receiver.
- Connect the equipment into an outlet on a circuit different from that to which the receiver is connected.
- Consult the dealer or an experienced radio / TV technician for help.

**Instructions to Users:** This equipment complies with the requirements of FCC (Federal Communication Commission) regulations, provided that following conditions are met. Video inputs : The input signal amplitude must not exceed the specified level.

**CAUTION:** Changes or modifications not expressly approved by the party responsible for compliance could void the user's authority to operate the equipment.

### Declaration of Conformity

According to 47CFR, Part 2 and 15 for

**Class B Personal Computers and**

**Peripherals; and / or**

**CPU Boards and Power Supplies used**

**with Class B Personal Computers:**

**We:** Mrantz America, Inc.

**Located at:** 440 Medinah Road Roselle, IL 60712 U.S.A.

**Telephone:** 630-307-3100

Declare under sole responsibility that the product identified herein, complies with 47CFR Part 2 and 15 of the FCC rules as a Class B digital device. Each product marketed, is identical to the representative unit tested and found to be compliant with the standards. Records maintained continue to reflect the equipment being produced can be expected to be within the variation accepted, due to quantity production and testing on a statistical basis as required by 47CFR §2.909. Operation is subject to the following two conditions: (1) This device may not cause harmful interference, and (2) This device must accept any interference received, including interference that may cause undesired operation. The above named party is responsible for ensuring that the equipment complies with the standards of 47CFR § 15.101 to 15.109.

**Trade name:** Plasma Display Monitor

**Model Number:** PD4298HD

# CONTENTS

SAFETY GUIDELINES .....	i
CONTENTS .....	1
FEATURES .....	2
INSTALLATION INSTRUCTIONS.....	3
Standard accessories .....	3
Installation .....	3
Anti-tumble measures.....	3
Component Names .....	4
Installation and Cabling .....	6
Handling the Remote Controller.....	8
OPERATING INSTRUCTIONS .....	9
Turning Power On and Off .....	9
Input Selection .....	10
Volume Adjustment .....	10
Contrast Adjustment .....	11
Sound Mute .....	11
Input Signal Status Display .....	11
On-Screen Display System .....	12
Displays According to Selected DISPLAY AREA (RGB Input) ...	17
OTHER FEATURES .....	18
Automatic Store .....	18
Reset (Settings Initialization) .....	19
Signal Check .....	19
Displays by Selecting the DISPLAY SIZES (Video input) .....	20
Power Save Mode .....	21
Sound Mode .....	21
TROUBLESHOOTING .....	22
Symptoms That Seemingly Appear to be Failures .....	22
Actions to Correct Abnormal Displays .....	24
PRODUCT SPECIFICATIONS .....	26
General Specifications .....	26
Signal Input .....	27
Recommended Signal List .....	28

# FEATURES

The following features are provided by the color Plasma Display Monitor.

## Large-screen, high-definition plasma display panel

The 42-inch color plasma display panel, with a resolution of 1024 (H) x 1024(V) pixels, creates a high-definition, large-screen (aspect ratio : 16:9) and low-profile flat display. Free from electromagnetic interferences from geomagnetic sources and ambient power lines, the panel produces high-quality display images free from color misconvergence and display distortion.

## Multimedia input support

The monitor comes complete with a mini-D-sub terminal and a BNC terminal for RGB input and with a composite/S terminal and a component terminal for video input, and even with stereo audio input terminals. It allows hooking up with a number of devices, from PCs to video gear.

## Multiscan converter and Flexible Control LSI

The multiscan converter provides a broad multiscan range of signals, from video signals (15 kHz) to PC analog video signals. Flexible Control LSI provides better video quality by processing video signal.

## Easy-to-use remote controller

The remote controller included eases the work of setting display controls. Further, the on-screen display system, displays the status of signal reception and display control settings in an easy-to-view fashion.

## Power saving system

Power saver feature saves power consumption automatically when input signals are not available. The monitor can be set to cut the power consumption to 5 W or below when video signal input is no longer available.

## Notes about This Manual

- The information in this manual is subject to change without notice.
- While meticulous care has been taken in the preparation of this manual, you are requested to notify your dealer or us should you have any comments, views or questions about our product.
- Fully understand the prerequisites to using the product, such as hardware and software specifications and constraints, in using the product. We are not held liable for damages caused by improper handling of the product.
- Reproduction of this manual in whole or in part without our prior written permission is prohibited.
- The product names mentioned in this manual may be trademarks or registered trademarks of their respective owners.

# INSTALLATION INSTRUCTIONS

## Standard accessories

- This product is complete with the display monitor, plus the accessories shown below.
  - If any of these accessories is missing, please contact your dealer.



Instruction manual  
(this book)



Remote-control  
transmitter



Warranty card



Power cable



Signal cable, mini-  
D-sub 15-pin

- Read the user's manual (this book) and the warranty card carefully and keep them in a safe place for handy reference.
- Retain the packing materials for use in future shipping or relocation.

## Installation

- To preserve the performance of this product and to maintain safety, always use one of the special mount units for installation.



### WARNING

- Use one of the special mount units to install this product. A mount of insufficient strength or inadequate design can cause overturning or dropping and result in fire, electrical shock or injury. Please note that our company assumes absolutely no responsibility for personal injuries or property damage caused by use of other mount units or improper installation.



### CAUTION

- Installation of the wall mount unit and ceiling mount unit can be dangerous, so do not attempt this work yourself. Ask your dealer to provide the name of a qualified installer.
- Consult your dealer before attempting to install this monitor on the desk-top stand.
- In order to prevent an internal temperature increase, maintain a space of 10cm or more between the sides and other objects such as walls, etc., so that the ventilation holes are not blocked.\*

## Anti-tumble measures



### CAUTION

- Have this unit mounted in a stable place. Take measures to prevent it from tumbling down to avoid possible physical injury.

## Securing to a wall or pillar

- 1) After positioning, the hooks included with the Desk-top Stand through the holes located on both ends (left and right) at the top and fasten with M4 screws, as shown in the diagram.

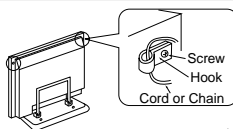

- 2) Using a commercially available cord, chain and clamp, secure the set to a firm wall or pillar.

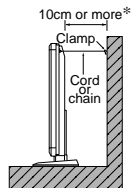

## Securing desktop

- 1) Using wood screws (two), fasten the set to the clamping screw holes on the rear of the stand as shown.
- 2) Using commercially available wood screws, secure the set firmly in position.

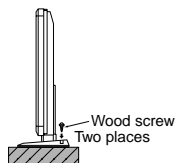

# INSTALLATION INSTRUCTIONS (continued)

ENGLISH

## Component Names

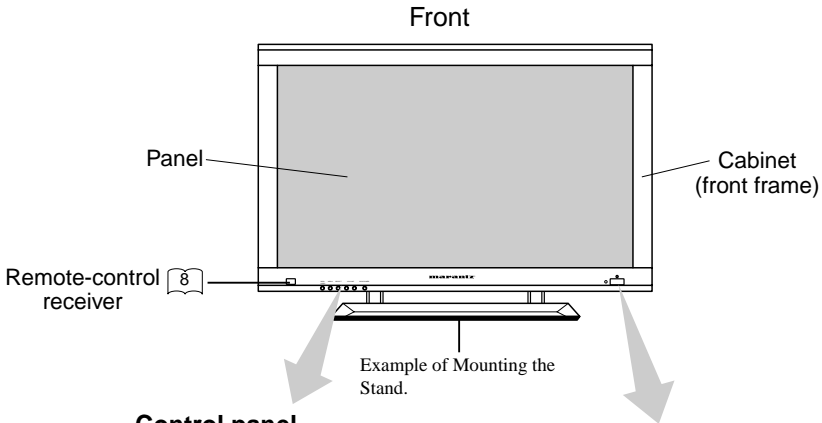

### Control panel

- Adjustment buttons are located on the bottom.

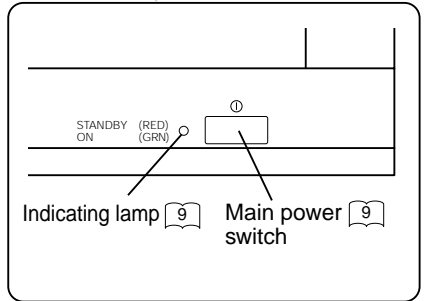
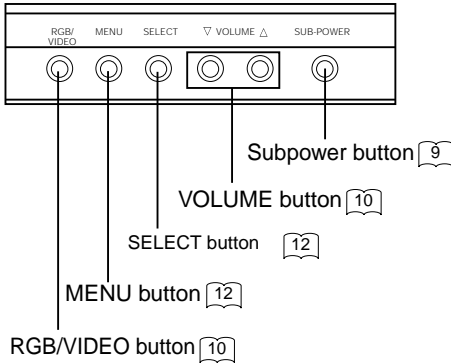
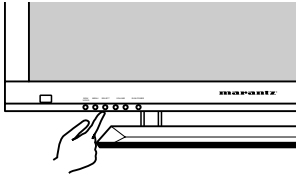

Rear

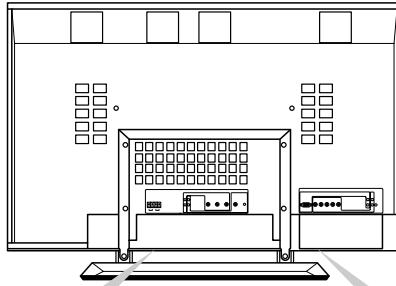

External device connection terminals

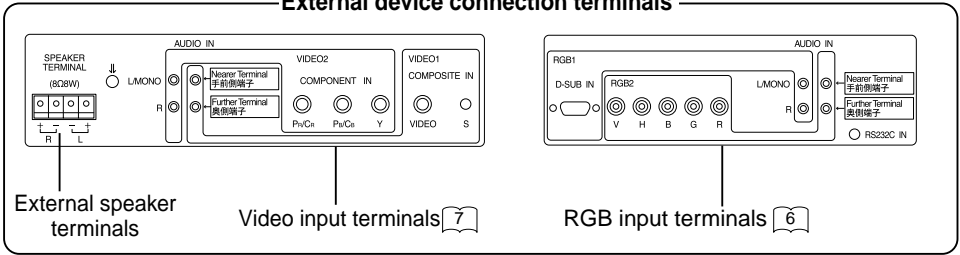

Remote controller

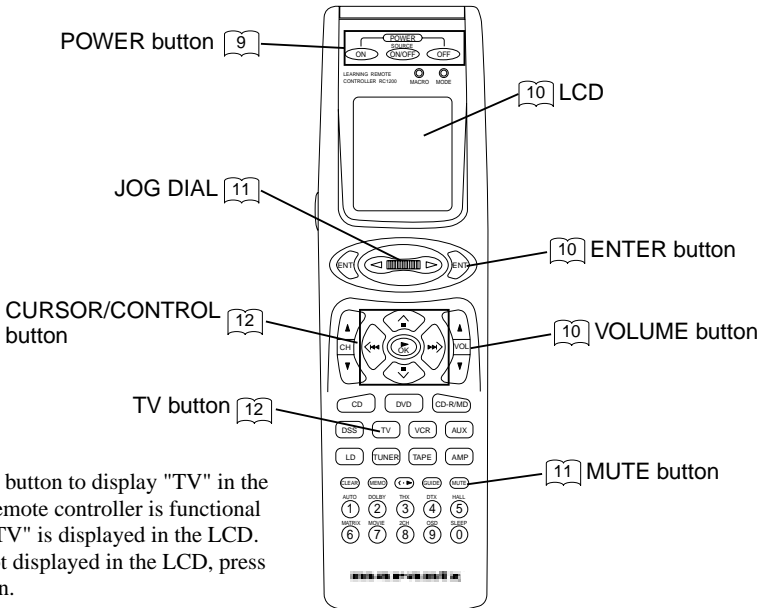

Press the TV button to display "TV" in the LCD. The remote controller is functional only when "TV" is displayed in the LCD. If "TV" is not displayed in the LCD, press the TV button.

# INSTALLATION INSTRUCTIONS (continued)

## Installation and Cabling

### Connecting to a PC

- Read SAFETY GUIDELINES ( [i](#) to [viii](#) ) carefully to ensure maximum safety before proceeding to these steps:
  - 1) Make sure that the display signals produced by your PC meet the specifications of this product.
    - For the specifications of this product, see Product Specifications ( [26](#) to [27](#) ).
  - 2) Choose an appropriate site and install the product on a level table where the stand is secure.
    - Install the monitor to have ready access to a power socket.
  - 3) Make sure that your PC's power switch is off.
  - 4) Interconnect the signal input terminal (RGB1) on the monitor rear panel and the display signal output terminal of the PC to each other using the signal cable included.
    - Optional cables are needed to connect to the RGB2 input and audio input terminals.
    - If the signal cable included does not match your PC, consult your dealer after reading the section "Signal Input". [27](#)
  - 5) Insert one end of the power cable included into the rear-panel power cable connector and the other end into a mains.
  - 6) Turn on the monitor, then the PC to make sure that a display image appears on the monitor screen.
    - For instructions on turning on the monitor and adjusting its display images, see "Operating Instructions" ( [9](#) to [17](#) ).

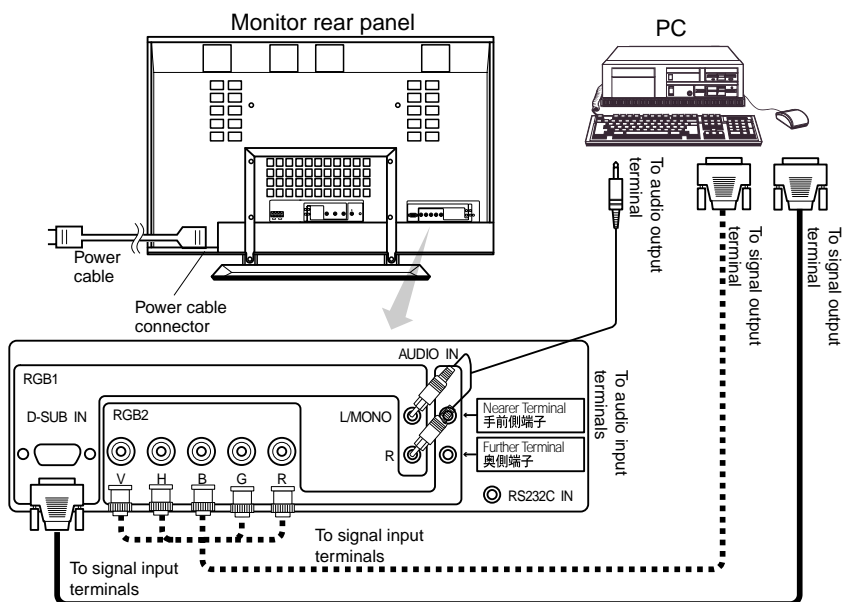



## Connecting to Video Equipment

(such as a Laser Disc player, a DVD player, a DSS, or a Video Camera)

- Read SAFETY GUIDELINES ( [ 1 ] to [ viii ] ) carefully to ensure maximum safety before proceeding to these steps:
  - 1) Choose an appropriate site and install the product on a level table where the stand is secure.
    - Install the monitor to have ready access to a power socket available.
  - 2) Make sure that the video equipment's power switch is off.
  - 3) Interconnect the signal input terminal on the monitor rear panel and the video equipment's signal output terminal to each other using an optional cable.
  - 4) Insert one end of the power cable included into the rear-panel power cable connector and the other end into a power socket.
  - 5) Turn on the monitor, then the video equipment's to make sure that a display image appears on the monitor screen.
    - For instructions on turning on the monitor and adjusting its display images, see "Operating Instructions" ( [ 9 ] to [ 17 ] ).

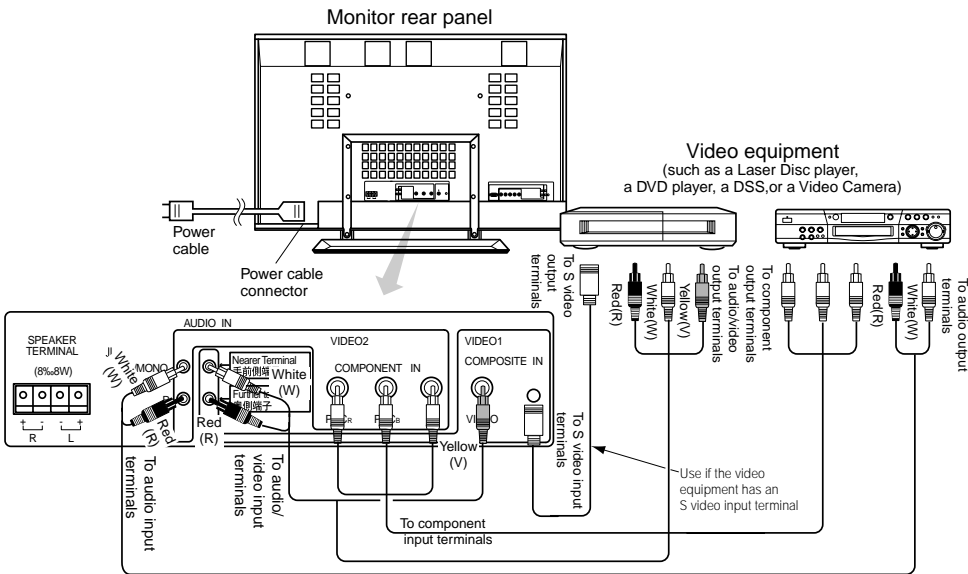

- If video equipment with an S video output terminal is used, cabling by the S video cable is recommended to provide finer video quality. (If an S video input terminal and a video input terminal connect to the monitor at the same time, S video input would govern.)

# INSTALLATION INSTRUCTIONS (continued)

## Handling the Remote Controller

### Loading Batteries

The life of the batteries used with the remote control unit is about 6 months with normal use. Also be sure to replace batteries earlier when you notice that they are getting weak. Do not use alkaline, manganese, nickel-cadmium (Ni-Cd) or other different types of batteries together.

- 1) Remove the back cover.
- 2) Insert the new batteries (AA type) with correct (+) and (-) polarity.
- 3) Close until it clicks.

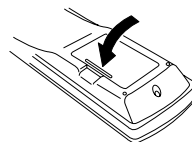
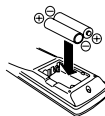
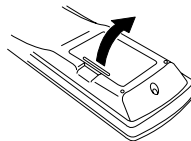

### Handling the Remote Controller

- Use the remote controller within about 15 feet from front of the unit's remote-control receiver and within 30 degrees on both sides.

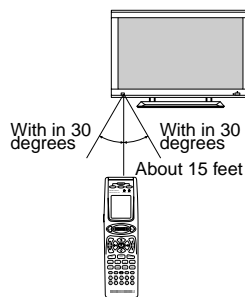

 <b>CAUTIONS</b>	<ul style="list-style-type: none"> <li>■ Do not use new and old batteries together. The batteries could explode or leak, resulting in fires, physical injury, or stains.</li> <li>■ When loading batteries, observe their correct polarities as marked on the product. If loaded in the wrong direction, the batteries could explode or leak, resulting in fires, physical injury, or stains.</li> </ul>
<b>TIPS</b>	<ul style="list-style-type: none"> <li>■ Do not drop or impact the remote controller.</li> <li>■ Do not splash the remote controller with water or put it on a wet object to avoid possible failures.</li> <li>■ Before leaving the remote controller out of use for an extended period of time, remove the batteries from it.</li> <li>■ If the remote controller begins to lack responsiveness, replace the batteries.</li> <li>■ Strong light such as direct sunlight impinging on the photoreceptor of the remote control can cause operational failure. Position this unit to avoid direct contact with such light.</li> </ul>

# OPERATING INSTRUCTIONS

## Turning Power On and Off

- To turn on the main unit power supply, main unit the MAIN POWER switch (Ⓢ) of the main unit to ON and then press the SUB POWER button or the POWER ON or POWER SOURCE ON/OFF button of the remote controller.
- To turn off the main unit power supply, press the SUB POWER button of the main unit or the POWER OFF or POWER SOURCE ON/OFF button of the remote controller, then main unit the MAIN POWER switch (Ⓢ) to OFF.
- For normal operations, leave the MAIN POWER switch (Ⓢ) main unit to ON and use the SUB POWER button or the POWER ON or POWER SOURCE ON/OFF button of the remote controller to turn the power on and off.

Indicating lamp	Power status	Operating
Off	Off	When the MAIN POWER switch Ⓢ is set to OFF.
Lights red	Off (standby)	When the MAIN POWER switch Ⓢ is set to ON and POWER OFF or POWER SOURCE ON/OFF button of the remote controller or the SUB POWER button on the main unit located at the front part of the bottom plate is off.
Lights or blinks green	On	When the MAIN POWER switch Ⓢ is set to ON and POWER ON or POWER SOURCE ON/OFF button of the remote controller or the sub power button on the main unit located at the front part of the bottom plate is on.

When the indicating lamp blinks in green or the message “POWER SAVE” or “OUT OF FREQUENCY” appears on the screen, there is something unusual about the status of reception. See “Symptoms That Seemingly Appear to be Failures.” 

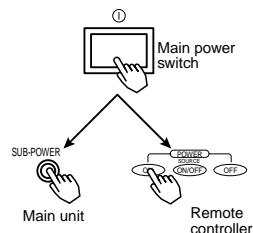

<b>TIPS</b>	<ul style="list-style-type: none"> <li>■ Avoid repeatedly turning the monitor on and off at short time intervals. <ul style="list-style-type: none"> <li>● Failures might result from such operation.</li> </ul> </li> <li>■ Turn off the main power switch (Ⓢ) before leaving the monitor out of use for an extended period of time.</li> <li>■ If a power failure occurs while the main unit is running, it would be powered on upon recovery from the failure. Turn off the unit main power switch before leaving the main unit.</li> </ul>
-------------	--

# OPERATING INSTRUCTIONS (continued)

Press the TV button to display "TV" in the LCD. The remote controller is functional only when "TV" is displayed in the LCD. If "TV" is not displayed in the LCD, press the TV button.

ENGLISH

## Input Selection

- Turn the remote controller jog dial to choose an input signal (VIDEO1, VIDEO2, RGB1, or RGB2) and press the ENT button. Turn the remote controller jog dial to choose INPUT and press the ENT button, or press the main unit RGB/VIDEO button to switch through VIDEO1, VIDEO2, RGB1, and RGB2 in this order.

- When the same signal is input to RGB1 and RGB2, the phase may in some cases shift slightly but this is not a malfunction. In such case, readjust the PHASE of the one being used.

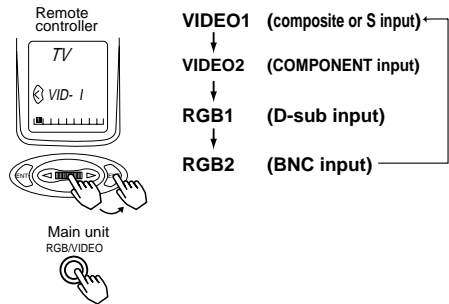

## Volume Adjustment

- While the on-screen display system is not on display, press the remote controller VOLUME button (VOL) ▲ or ▼ (or the main unit VOLUME button ▲ or ▼) to adjust the sound volume.

- The adjustment status will be displayed as guidance while you press these buttons.

- While the guidance is on display, press ▲ to turn up the volume.
- While the guidance is on display, press ▼ to turn down the volume.

- You can also adjust the sound volume setting via the on-screen display system. 12

- The sound volume adjustment mode will exit when no keys are entered for 5 seconds. (The adjustment status guidance will disappear automatically.)

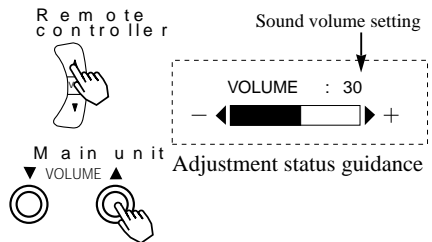

## Sound Mute

- Press the remote controller MUTE button to mute the sound temporarily.

- When you press the button, [MUTE] (pink) and the status of volume setting will be displayed in a guidance image.

- While the sound is muted, press the VOLUME button ▼ to turn down the volume.
    - While the sound is muted, press the VOLUME button ▲ to cancel the mute.

- You can also adjust the sound volume setting of the mute via the on-screen display system. 

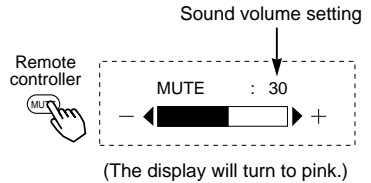

- Press the remote controller MUTE button once again and the mute will be canceled and the guidance will change to VOLUME (blue), enabling the volume to be heard.

- When MUTE is used, the guide display will continue for 5 sec. and then turn off.

## Input Signal Status Display

- Turn the remote controller jog dial to choose RECALL and press the ENT button to show the input signal state on the screen.
- Choose RECALL once again and press the ENT button to exit the screen.

- The contrast adjustment mode will exit when no keys are entered for 5 seconds.

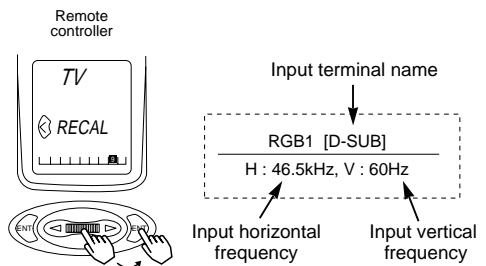

# OPERATING INSTRUCTIONS (continued)

ENGLISH

## On-Screen Display System

- Either turn the remote controller jog dial to choose MENU and press the ENT button or press the main unit MENU button to open the Main Menu. The adjustment menu lets you program multiple adjustments or settings by using the CURSOR/CONTROL buttons (on the remote controller, the  $\wedge$ ,  $\vee$ ,  $\langle$ ,  $\rangle$  buttons; on the main unit, the SELECT and VOLUME  $\blacktriangle$  and  $\blacktriangledown$  buttons).

- Press the SELECT button of the main unit ( $\wedge$  or  $\vee$  key of the remote controller) to select an item by moving the pink text.
- Press the VOLUME button and the  $\blacktriangle$  and  $\blacktriangledown$  keys of the main unit ( $\langle$  or  $\rangle$  key of the remote controller) to adjust or set the selected item, or to switch the menu.
- When a choice is followed by “:”, it indicates that the choice can be adjusted or changed.
- When a choice is followed by  $\blacktriangleright$ , a menu can be opened by pressing the remote-controller CURSOR/CONTROL button  $\rangle$  or the main unit SELECT button and VOLUME button  $\blacktriangle$ .
- When [RETURN] is selected, press the remote-controller button CURSOR/CONTROL ( $\langle$  or the main unit SELECT button and VOLUME button  $\blacktriangledown$ ) to exit to the original menu
- For information on adjusting and setting choices, see 13 to 16.

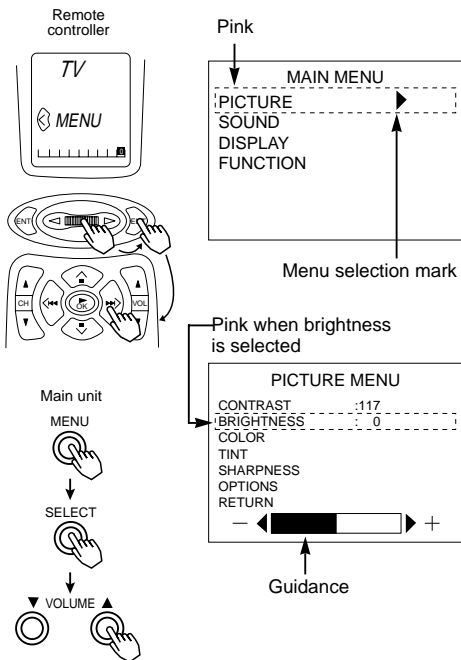





- Press the MENU button once again to exit the Main Menu.
  - The Main Menu will close automatically when no keys are entered for 10 seconds.

<b>Useful knowledge</b>	<ul style="list-style-type: none"> <li>■ It is recommended that, when inputting a computer signal to the main unit to get a grasp of the overall image, the DISPLAY AREA of a 1024 x 768 VESA display at 75Hz be set to FULL with SCAN set to INT. 14</li> <li>■ Flicker can occur when a personal computer signal is input. If the vertical frequency is less than 75Hz, it is recommended that the vertical frequency be increased (upper limit: 75Hz).</li> </ul>
-------------------------	--

<b>HINTS</b>	<ul style="list-style-type: none"> <li>■ Burn-in (residual image) can occur if the same image is displayed for an extended time. To reduce this possibility, change the display contents at suitable intervals.</li> <li>■ If special images created on a PC or any other equipment (such as those composed of a checker-flag pattern) are displayed across the screen, the hue may be varied depending on the contrast or brightness setting.</li> </ul>
--------------	---

# Adjustment Item List

Menu item	Selected characters	Adjustment item			Setup hint	
M A I N	PICTURE (if RGB is selected)	CONTRAST	Contrast	Narrows the gap between brightness and darkness.	Broadens the gap between brightness and darkness.	Adjust for maximum visibility to suit the ambient brightness.
		BRIGHTNESS	Brightness	Black is subdued for increased overall darkness.	Black is set off for increased overall brightness.	Adjust to prevent black from spreading across the screen.
		OPTIONS	COLOR SELECT	Color temperature	WARM ↓ NORM ↑ COOL	WARM ↑ NORM ↓ COOL
	GAMMA		Gamma correction	1.0 ↑ 2.2 ↓ 2.8	1.0 ↓ 2.2 ↑ 2.8	Normally set to 2.2.
	VIDEO LEVEL		Input signal level	Set to 0.7 V.	Set to 1.0 V.	Normally set to 0.7 V. If white is found to spread across the screen, set to 1.0 V.
	PICTURE (if VIDEO is selected)	CONTRAST	Contrast	Narrows the gap between brightness and darkness.	Broadens the gap between brightness and darkness.	Adjust for maximum visibility to suit the ambient brightness.
		BRIGHTNESS	Brightness	Black is subdued for increased overall darkness.	Black is set off for increased overall brightness.	Adjust for visibility to suit the darkness of black hair.
		COLOR	Color (color density)	Lightens colors.	Darkens colors.	Adjust for desired density, somewhat for lighter colors for a natural look.
		TINT	Tint	Enhances red and weakens green.	Enhances green and weakens red.	Adjust for a nice looking skin color.
		SHARPNESS	Sharpness	Softens display images.	Sharpens display images.	Normally set to middle, and towards - for increased softness.
	OPTIONS	COLOR SELECT	Color temperature	WARM ↓ NORM ↑ COOL	WARM ↑ NORM ↓ COOL	Normally set to COOL.
		GAMMA	Gamma correction	1.0 ↑ 2.2 ↓ 2.8	1.0 ↓ 2.2 ↑ 2.8	Normally set to 2.2.
		VIDEO LEVEL	Input signal level	NORMAL ↑ +10% ↓ +20%	NORMAL ↓ +10% ↑ +20%	Normally set to NORMAL. If white is found to spread across the screen, set to +10% or +20%.
	SOUND	VOLUME	Sound volume	Turns down the volume.	Turns up the volume.	Adjust for the desired sound volume. 
		BALANCE	Sound balance	Enhances left-side sound.	Enhances right-side sound.	Adjust to taste.
TREBLE		Treble	Suppresses treble.	Enhances treble.		
BASS		Bass	Suppresses bass.	Enhances bass.		
MUTE LEVEL		Mute volume	Turns down the sound volume. Minimum 0.	Turns up the sound volume. Maximum pre-mute sound volume.	Sets the sound volume for when the MUTE button is pressed. 	

# OPERATING INSTRUCTIONS (continued)

## Adjustment Item List (continued)

ENGLISH

Menu item	Selected characters	Adjustment item			Setup hint
M A I N	DISPLAY AREA	VGA APPLE 13-inch	NORMAL ↔ FULL		Set to FULL to display images across the screen for gaining an overview of the overall images.  A schematic view of the display is shown on <b>17</b> .
		SVGA XGA SXGA(60) APPLE 16-inch 19-inch	FULL ↑ UP/LF ↑ UP/RI ↑ DW/LF ↑ DW/RI ↑ CENTER	FULL ↓ UP/LF ↓ UP/RI ↓ DW/LF ↓ DW/RI ↓ CENTER	
		SXGA(75)	FULL		
	H.POSITION	Horizontal position			Adjust the left-side display position.
	V.POSITION	Vertical position			Adjust the vertical display position.
	CLOCK	Dot clock frequency	Reduces the dot clock frequency (shrinks the right side). 	Increases the dot clock frequency (expands the right side). 	Adjust for maximum character clarity. <b>24</b>
PHASE	Dot clock phase	Slows the dot clock phase (shifts slightly to left). 	Advances the dot clock phase (shifts slightly to right). 	Adjust for clear character visibility. <b>25</b>	
SCAN (*)	Scan system	INT ↔ P.SCAN		Setting INT when FULL display is not possible while receiving an signal above SVGA makes text easier to view.	
DISPLAY INIT.	INITIALIZE	Display initialization	Clears all DISPLAY MENU adjustment values and exits to the DISPLAY MENU.	Exits to the DISPLAY MENU, without clearing the menu adjustment values.	Clear the user signal preset data. <b>19</b>
DISPLAY (if VIDEO is selected)	DISPLAY SIZE	Display size	4:3 → FULL ↑ PANOR. ↑ MOVIE1 ↓ MOVIE2	4:3 ← FULL ↓ PANOR. ↓ MOVIE1 ↑ MOVIE2	Select to suit the aspect ratio of the video software.
	V.POSITION	Vertical position MOVIE1/MOVIE2			Adjust the vertical position when subtitles cannot be read.
	V.SIZE	Vertical size MOVIE1/MOVIE2			Adjust until the black band (blanking) at the top and bottom is no longer visible.



\* Displayed only when FULL is selected as the DISPLAY AREA.

- The display mode is stored in memory separately for video and component video.
- Componet/S signal (video1 input) and componet (SD1 480I) signal applicable for all modes.
- For component (HD1: 480P) signals, the display mode is selectable among 4:3, MOVIE1, and FULL.
- For component (HD3: 1035I, 1080I) signals, the display mode is not selectable.

**14** ● If an S1 or S2 image is input from the video 1S image, the S1 image would be set to FULL, and the S2 image would be set to MOVIE1.



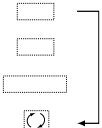
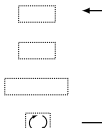

## Adjustment Item List (continued)

Menu item		Selected characters	Adjustment item			Setup hint	
M A I N	FUNCTION (if RGB is selected)	LANGUAGE	Language selection	ENG.(English) ↑ FRA.(French) ↑ ESP.(Español) ←	ENG.(English) ↓ FRA.(French) ↓ ESP.(Español) ←	The default is ENG (English).	
		AUTO FREQ.	Input status automatic display	Set to OFF The frequency of a new signal is not displayed received.	Set to ON. The frequency of a new signal is displayed as it is received.	Set to OFF if you find the frequency display appearing upon signal change embarrassing.	
		INTERPOLATION	Enlargement	Set to DOUBLE.	Set to LINEAR.	Set to DOUBLE to see characters or images crisp or to LINEAR to view them smooth.	
	SCREEN SAVER	SCREEN SAVER	A. Burn-in reduction function	Set to OFF.	Set to ON.	Set to ON when burn-in is bothersome.	
		MOVING MODE	Screen shift mode select			Set the desired shift mode.	
		MOVING DOTS	Screen shift amount select	Reduces the amount of movement.	Increases the amount of movement.	Adjust as desired.	
		MOVING TIMER	Shift time interval select	Reduces the time interval.	Increases the time interval.	Shift time can be set from 1 min. to 60 min. (Use zero (0) to check the shift range. Shift time will be approx. 1 sec.)	
	FUNCTION (if VIDEO is selected)	LANGUAGE	Language selection	ENG.(English) ↑ FRA.(French) ↑ ESP.(Español) ←	ENG.(English) ↓ FRA.(French) ↓ ESP.(Español) ←	The default is ENG. (English).	
		AUTO FREQ.	Input status automatic display	Set to OFF The frequency of a new signal is not displayed received.	Set to ON. The frequency of a new signal is displayed as it is received.	Set to OFF if you find the frequency display appearing upon signal change annoying.	
		LINE INTP.	Line correction	Set to OFF.	Set to ON.	Set to ON when playing a 3D-video disc. Set to OFF in most cases.	
		3D COMB	Three-dimensional Y/C separation	Set to OFF.	Set to ON.	Set to OFF if video images appear unnatural. Set to ON in most cases.	
		COMPONENT	COMPONENT SD1	480I signal color matrix	Set to Cb/Cr to suit the Y/Cb/Cr signals.	Set to Pb/Pr to suit the Y/Pb/Pr signals.	The default is
COMPONENT SD2			European SDTV signal color matrix	Y/Cb/Cr			
COMPONENT HD1			480P signal color matrix	Y/Pb/Pr			
COMPONENT HD2			720P signal color matrix	Y/Pb/Pr			
COMPONENT HD3	1080I signal color matrix		Y/Pb/Pr				

# OPERATING INSTRUCTIONS (continued)

## Adjustment Item List (continued)

ENGLISH

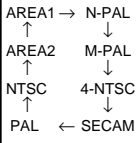
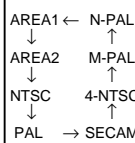
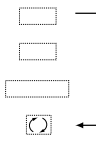
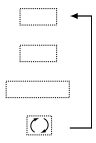
Menu item		Selected characters	Adjustment item			Setup hint
M A I N	FUNCTION (if VIDEO is selected)	VIDEO SYSTEM	Color system setting			Switch the color system to suit the input system in video input mode (VIDEO1). ● Normally, set to AREA1. The input signal system will be automatically recognized to display input images on the screen (Japan, Europe, and North America). (Choose AREA2 in South America.) ● If the input signal contains much noise or has a low level (AREA1, 2) and the operation is found erratic, set to match the input system.
		SCREEN SAVER	A. Burn-in reduction function	Set to OFF.	Set to ON.	Set to ON when burn-in is bothersome.
	SCREEN SAVER	MOVING MODE	Screen shift mode select			Set the desired shift mode.
		MOVING DOTS	Screen shift amount select	Reduces the amount of movement.	Increases the amount of movement.	Adjust as desired.
		MOVING TIMER	Shift time interval select	Reduces the time interval.	Increases the time interval.	Shift time can be set from 1 min. to 60 min. (Use zero (0) to check the shift range. Shift time will be approx. 1 sec.)

- Be sure to use MOVING TIMER 0 to verify the range of movement of SCREEN SAVER before running it. If image voids are of concern, adjust the image with MOVING MODE and MOVING DOTS.
- SCREEN SAVER does not eliminate baking completely but alleviates baking by refreshing display images at appropriate intervals of time.

*Displays According to Selected DISPLAY AREA (RGB Input)*

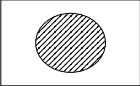
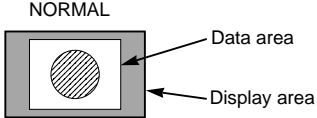
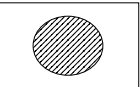
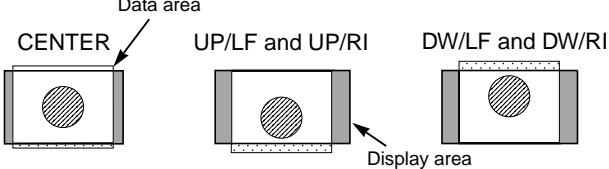
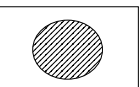
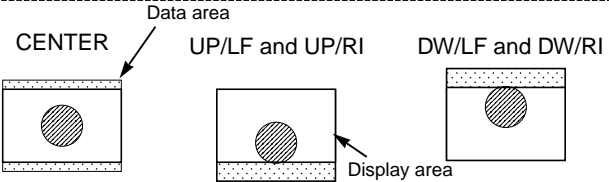
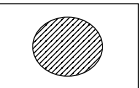
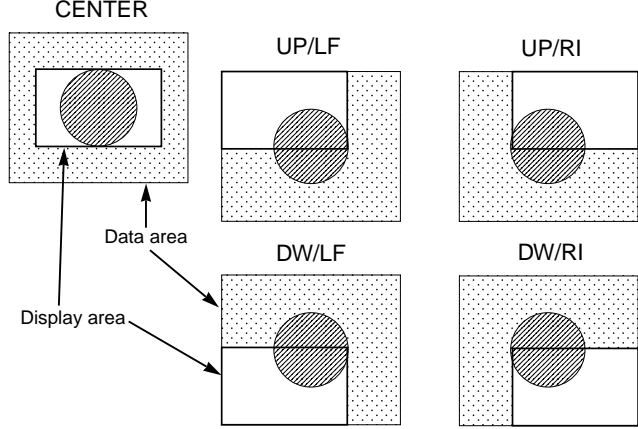
Resolution	Overall display	Others (Partial display)
VGA (640X480)	FULL 	NORMAL 
SVGA (800X600)	FULL 	
XGA (1024X768)	FULL 	
* SXGA (1280X1024)	FULL 	

\* Only FULL display is possible with SXGA (1280 x 1024) - 75Hz.  
Overall display (FULL) fills the display area with data; therefore, compression (interpolation) and expansion processing will be performed.

# OTHER FEATURES

## Automatic Store

- Approximately 1 sec. after adjustment is completed, the adjustments will be recorded as shown in the table below.

Item	Display	Registration condition	Reproduction condition
Sound volume Sound balance Treble Bass Mute volume Input status automatic display Enlargement Line correction Three-dimensional Y/C separation HD signal Language selection	VOLUME BALANCE TREBLE BASS MUTE LEVEL AUTO FREQ. INTERPOLATION LINE INTP. 3D COMB COMPONENT LANGUAGE	One set can be recorded.	During normal signal reception.
Brightness Contrast Color temperature Gamma correction Input signal level	BRIGHTNESS CONTRAST COLOR SELECT GAMMA VIDEO LEVEL	One set can be recorded during common RGB1, RGB2 input; one set of two can be recorded during normal signal reception with common VIDEO 1, VIDEO 2 input.	During normal signal reception.
Color Tint Sharpness	COLOR TINT SHARPNESS	One set can be recorded during common VIDEO 1, VIDEO 2 input.	During normal signal reception.
Display area Display size Horizontal position Vertical position Dot clock frequency Dot clock phase Vertical size	DISPLAY AREA DISPLAY SIZE H.POSITION V.POSITION CLOCK PHASE V. SIZE	One group can be recorded for each signal mode.	During recording and when the same signal mode is detected.

- The previously recorded items will be lost.
- The signal mode can be identified by the horizontal/vertical sync frequency and the sync signal polarity. Different signals with which all the elements are the same or similar will be handled as the same signal.
- Contents that can be recorded are supplied for each signal mode for RGB 1 and RGB 2 input, and for VIDEO 1 or VIDEO 2 input. Because of this, adjustment may not be appropriate when contents recorded with RGB 1 (or RGB 2) is received with RGB 2 (or RGB 1), and when contents recorded with VIDEO 1 (or VIDEO 2) is received with VIDEO 2 (or VIDEO 1) in the same signal mode.

## Reset (Settings Initialization)

- The shown to the right will be displayed when the CURSOR/CONTROL button is used to select DISPLAY and moreover DISPLAY INT is selected from the On-screen Display System <sup>12</sup>. If the ◀ button (select YES) of the CURSOR/CONTROL button is pressed at this time, the user adjustment values in the table below for the signal currently being received will be deleted and the factory settings will be restored.

INITIALIZE ?  
YES ◀ NO

- Pressing the ▶ button (select NO) cancels deletion and returns the DISPLAY menu.

DISPLAY menu item	Display	Application
H.POSITION	H.POSITION	RGB1, RGB2
V.POSITION	V.POSITION	RGB1, RGB2, VIDEO1, VIDEO2
CLOCK	CLOCK	RGB1, RGB2
PHASE	PHASE	RGB1, RGB2
Scan system	SCAN	RGB1, RGB2
Vertical size	V. SIZE	VIDEO1, VIDEO2
Display area	DISPLAY AREA	RGB1, RGB2
Display size	DISPLAY SIZE	VIDEO1, VIDEO2

## Signal Check

- The status of signal reception is checked automatically and the result is displayed on the screen.

Status	Display	Action
Signals are received normally.	<ul style="list-style-type: none"> <li>The input terminal and the horizontal and vertical frequencies are displayed in a guidance image.</li> </ul>	-
A sync signal could not be detected.	<ul style="list-style-type: none"> <li>The guidance message "POWER SAVE" is displayed for about 5 seconds.</li> <li>In the event of continued absence of a sync signal, the power indicating lamp flickers and the monitor enters power save mode.</li> </ul>	<ul style="list-style-type: none"> <li>Check the power switch of the PC and its status of connection.</li> </ul>
The input signal does not meet display specifications or erratic.	<ul style="list-style-type: none"> <li>The guidance message "OUT OF FREQUENCY" is displayed for about 5 seconds.</li> </ul>	<ul style="list-style-type: none"> <li>Check the input signal specifications once again.</li> </ul>

RGB1 [D-SUB]  
H : 46.5kHz, V : 60Hz

Either VIDEO or S VIDEO is displayed on VIDEO input.

POWER SAVE

OUT OF FREQUENCY

# OTHER FEATURES (continued)

## Displays by Selecting the DISPLAY SIZE (Video input)

ENGLISH

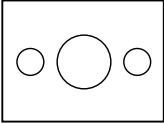
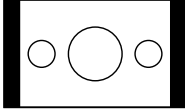
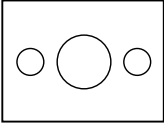
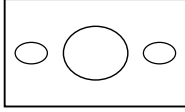
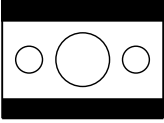
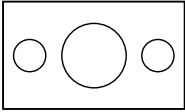
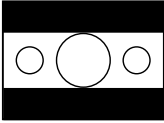
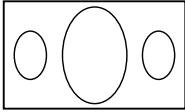
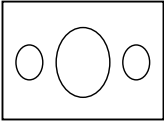
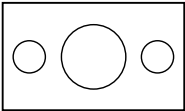
When you want to	Set the display size to	Input signal (4:3 signal)	Display screen	Remarks
Play a 4:3 image in a 16:9 screen faithfully.	4:3			Blanking occurs on both sides.
Play a 4:3 image in a 16:9 screen with the height and width of the middle of the screen enlarged on equal scales and with both sides appearing somewhat enlarged.	PANOR. (Panoramic)			
The 16:9 VISTA size image in the 4:3 image is faithfully reproduced on the 16:9 screen.	MOVIE1			<ul style="list-style-type: none"> <li>● The 4:3 image is called a letterbox image.</li> <li>● In some cases, some slight blanking may remain at the top and bottom.</li> </ul>
The 21:9 Cinema size image in the 4:3 image is expanded vertically on the 16:9 screen.	MOVIE2			In some cases, some slight blanking may remain at the top and bottom.
Play a 4:3 image faithfully in a 16:9 screen in the standard vertical size and horizontally squeezed.*	FULL			*An image with an aspect ratio of 16:9 shrunk horizontally to 4:3 to display in a 4:3 screen

### HINTS

#### Using a wide-screen monitor

- This monitor has a screen mode selection feature. If an incompatible screen mode is selected to play certain software, such as a TV program, the image would appear different from the original. Take this into consideration when making screen mode choices.
- Use of this monitor in its enlarged display mode with the wide feature enabled in coffee shops, hotels and other establishments for commercial or public viewing purposes could infringe on the copyright holder's right protected by Copyright Law.
- When a normal 4:3 image is displayed over the entire screen in the PANOR. mode, not the Wide mode, parts of the periphery of the image may disappear and/or appear distorted in some cases. Use the 4:3 mode to view images, according to the manufacturer's concept.

# TROUBLESHOOTING

## Power Save Mode

- When the RGB input jack is selected
- When this main unit is connected to a VESA DPMS computer, the Power Save (Off) mode can be set to be activated automatically when the computer is not being used to reduce power consumption by this main unit.

RGB sync signal	Horizontal	Yes	No	Yes	No
	Vertical	Yes	Yes	No	No
Video signal		Active (normal display)		Blank (no video)	
Operation mode		On		Off <sup>1)</sup>	
Indicating lamp		Lights green		Blinks green	
Power consumption		450W (standard)		5W or less	

- 1) Either turn the remote controller jog dial to choose MENU and press the ENT button or press the main unit MENU button. Otherwise, press the CURSOR/CONTROL buttons to switch to the sound mode. 

## ■ When the Video Input jack is selected

- When there is no video signal input, the power-saving system operates to reduce the power consumed by the main unit.

Video signal	Yes	No
Operation mode	On	Off <sup>1)</sup>
Screen display	Normal display	Blank (no video)
Indicating lamp	Lights green	Blinks green
Power consumption	450W (standard)	5W or less

- 1) Either turn the remote controller jog dial to choose MENU and press the ENT button or press the main unit MENU button. Otherwise, press the CURSOR/CONTROL buttons to switch to the sound mode. 

## Sound Mode

- While the power saver feature  is in the off mode, either turn the remote controller jog dial to choose MENU and press the ENT button or press the main unit MENU button to exit the off mode and enable sound output.

- When the monitor enters sound mode, it displays a mode indication on the screen.

- In sound mode, sound volume can be adjusted.

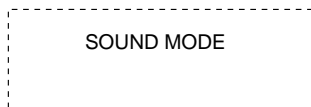

- Press the remote controller jog dial to choose MENU and press the ENT button or press the main unit MENU button to cancel sound mode.

- Power save mode  is enabled when sound mode is canceled.

- If an input signal is available, the monitor displays the input signal by canceling sound mode automatically.

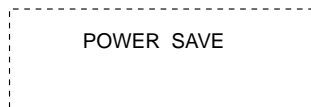





























# TROUBLESHOOTING (continued)

## Symptoms That Seemingly Appear to be Failures

- Make the checks suggested below depending on the symptoms observed. If the symptoms remain uncorrected, contact your dealer.

	<b>WARNING</b>	■ Customer servicing can be hazardous.
---	----------------	--

Symptom	Point to check	See page
<ul style="list-style-type: none"> <li>● The screen appears blank with the power-indicating lamp off.</li> </ul> 	→ Check the way the power cable is connected. → Press the power switch.	  
<ul style="list-style-type: none"> <li>● The message "POWER SAVE" is displayed.</li> <li>● The screen appears blank with the power indicating lamp flickering in green.</li> </ul>  	No sync signal is detected. → Check the way the signal cable is connected. → Make sure that the switch of the computer, imaging equipment, etc., is turned on. → Make sure the computer is not in the power-save mode. → Check to see if the input selection matches the connection terminal.	    
<ul style="list-style-type: none"> <li>● The message "OUT OF FREQUENCY" is displayed.</li> </ul> 	An input signal is not received normally. → Check to see if the input signal matches the monitor specifications. → Check the way the signal cable is connected.	  
<ul style="list-style-type: none"> <li>● The power indicating lamp is normally lit but the screen appears blank.</li> </ul> 	→ Check the contrast and brightness settings (adjust them for higher contrast and brightness). → Check the way the signal cable is connected.	   
<ul style="list-style-type: none"> <li>● The display image appears flowing slantwise.</li> <li>● Text displayed across the screen appears vertically streaked, with the characters in vertical columns blurred.</li> </ul>  	→ Adjust the dot clock frequency and phase. (Adjust the dot clock frequency first, the dot clock phase next.)	 
<ul style="list-style-type: none"> <li>● Text displayed across the screen appears blurred.</li> <li>● A fine pattern flickers when displayed on the screen.</li> </ul>  	→ Adjust the dot clock phase for the clearest viewing.	 
<ul style="list-style-type: none"> <li>● The remote controller does not work.</li> </ul>	→ Check to see if the batteries are loaded in the remote controller in opposite direction. → Check to see if the batteries in the remote controller are OK.	



Symptom	Point to check	See page
<ul style="list-style-type: none"> <li>● Flicker causes stripes to move up and down (during personal computer signal input).</li> </ul>	→ When the vertical frequency of the personal computer is lower than 75Hz, try increasing the frequency (upper limit: 75Hz). This may improve the situation in some cases.	—
<ul style="list-style-type: none"> <li>● The temperature of the display panel surface is high.</li> </ul>	→ The plasma display panel is lighting the phosphors by the discharge of internal radiation. In some cases, this may cause the temperature of the panel surface to increase. Please note that this is not a malfunction.	—
<ul style="list-style-type: none"> <li>● There are locations on the screen that are different from the periphery (*). *Points that do not light, points with brightness different from that of the periphery, points with color different from that of the periphery, etc.</li> </ul>	→ High-precision technology is used to manufacturing the plasma display panel but, in some cases, there are minor defects in some parts of the screen. Please note that this is not a malfunction.	—
<ul style="list-style-type: none"> <li>● Vertical stripes appear, depending on the screen contents.</li> </ul>	→ The plasma display panel is lighting the phosphors by the discharge of internal radiation. Depending on the screen contents, in rare cases this may cause vertical stripes to appear because of failure to light. Please note that this is not a malfunction.	—
<ul style="list-style-type: none"> <li>● Coarse horizontal stripes appear in FULL display.( durning personal computer signal input)</li> </ul>	→ A visual illusion may cause it. Adjusting the phase will reduce the horizontal stripes.	—

# TROUBLESHOOTING (continued)

## Actions to Correct Abnormal Displays

ENGLISH

- Depending on the kind of system equipment used, images may not be displayed normally. In this case, make the adjustments suggested below.

Symptom 1	Text displayed across the screen appears vertically streaked, with some characters blurred (display 1). The display image appears flowing (display 2) (RGB input).
Example	<p>Display 1</p> <p>Vertical streaks are blurred.</p> <p>Before adjustment some characters are blurred.</p> <p>After adjustment All characters appear crisp now.</p> <p>Adjust [25].</p>
Adjustment procedure	<ol style="list-style-type: none"> <li>1) Either turn the remote controller jog dial to choose MENU and press the ENT button or press the main unit MENU button to open the adjustment menu.</li> <li>2) Press CURSOR/CONTROL button <math>\curvearrowright</math> several times to choose DISPLAY.</li> <li>3) Press <math>\rangle</math> to open the DISPLAY menu.</li> <li>4) Press <math>\curvearrowright</math> several times to choose CLOCK. (Adjust the clock by displaying a fine pattern, such as a character string, or vertical streak pattern across the screen.)</li> <li>5) Press <math>\rangle</math> or <math>\langle</math> to make the text appear uniform across the screen.</li> <li>6) If the text appears blurred across the screen, make the adjustment instructed in Symptom 2. [25]</li> </ol>

- The display image may be momentarily disturbed during clock adjustment but this is not a failure.

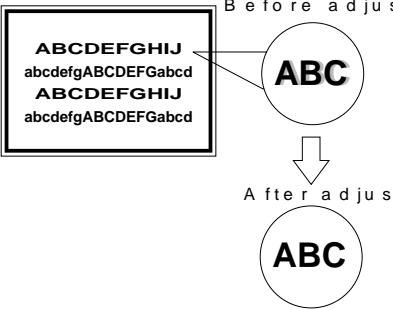
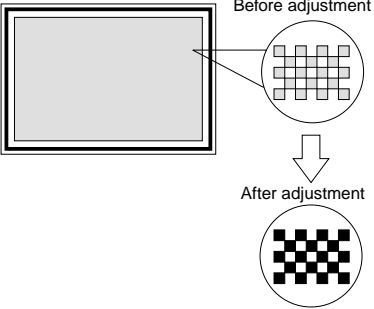
Symptom 2	Text displayed across the screen appears blurred in its entirety (display 2). A fine pattern flickers when displayed on the screen (display 3).	
Example	<p>Display 2</p> 	<p>Display 3</p> 
Adjustment procedure	<ol style="list-style-type: none"> <li>1) Either turn the remote controller jog dial to choose MENU and press the ENT button or press the main unit MENU button to open the adjustment menu.</li> <li>2) Press CURSOR/CONTROL button <math>\curvearrowright</math> several times to choose DISPLAY.</li> <li>3) Press <math>\curvearrowright</math> to open the DISPLAY menu.</li> <li>4) Press <math>\curvearrowright</math> several times to choose PHASE. (Adjust the phase by displaying a fine pattern, such as a character string, or vertical streak pattern across the screen.)</li> </ol>	
	5) Press $\curvearrowright$ or $\curvearrowleft$ to make the text appear clean across the screen.	5) Press $\curvearrowright$ or $\curvearrowleft$ to make the text appear without flickering.

# PRODUCT SPECIFICATIONS

■ Product specifications and designs are subject to change without notice.

ENGLISH

## General Specifications

Type		PD4298HD	
Panel	Display dimensions	Approx. 42 inches (922 mm (H), vertical 522 mm (V), diagonal 1059 mm)	
	Resolution	1024 (H) x 1024 (V) pixels	
Input signals	Input terminals	RGB input	VIDEO input
		RGB two-line two input terminals (D-sub 15-pin) (BNC) RGB audio two-line two input terminals (left, right)	Video 1 video input terminal Video 1 audio input terminal (left, right) Video 1 S video input terminal Video 2 video input terminal (Y) (Pb/Cb) (Pr/Cr) Video 2 audio input terminals (left, right)
	Video signals	0.7 V/1.0 Vp, analog RGB (horizontal: 24k to 80k, vertical: 50 Hz to 75 Hz)	NTSC, 480i, 480p, 720p, 1080i PAL, PAL M/N, (SECAM)
	Sync signals	H/V separate, TTL level	-
		H/V composite, TTL level	-
Sync on green, 0.3 Vp-p		-	
Recommended Signal	16 modes 	-	
Audio output terminal	8W + 8W (EIAJ)		
Input power	AC100 - 120 / 200 - 240V(automatically selected) 5A / 2.5A Power consumption 450W (typ.)		
External dimensions	1,041 (W) x 648 (H)x 89 (D) (mm) (excluding the stand)		
Mass	34 kg (excluding the stand)		
Ambient conditions	Temperature	Operating: 5°C to 35°C, Storage : 0°C to 40°C	
	Relative humidity	Operating: 20% to 80%, Storage : 20% to 90% (non-condensing)	

■ The monitor takes at least 30 minutes to attain the status of optimal picture quality.

## Signal Input

### ● RGB terminal (D-sub 15-pin connector)

Pin	Input signal
1	R. video
2	G. video or sync on green
3	B. video
4	No connection
5	No connection
6	R.GND
7	G.GND
8	B.GND
9	No connection
10	GND
11	No connection
12	No connection
13	H. sync or H/V composite sync
14	V.sync.
15	No connection

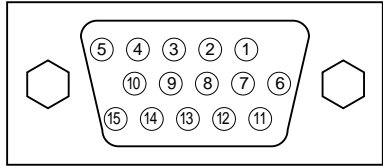

- When different kinds of input signals are simultaneously input to the monitor via a graphics board or the like, the monitor will automatically select the signals in the following priority order:

Sync signal type	Priority
H/V separate sync.	1
H/V composite sync.	2
sync.on Green	3

### ● RGB terminal (BNC connector)



V.sync.



H. sync or H/V composite sync



B. video



G. video or sync on green



R. video

### ● S-input connector pin specifications

Pin	Input signal
1	Y
2	Y-GND
3	C
4	C-GND
Frame	GND

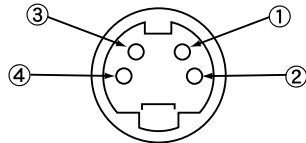

### ● Serial connector pin specifications (for service use)

Pin	Input signal	Remarks
1	NC	
2	RXD0	Unit ← PC
3	TXD0	Unit → PC
4	GND	
5	NC	
6	GND	
7	NC	
8	NC	
Frame	GND	GND

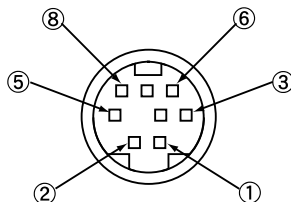

# PRODUCT SPECIFICATIONS (continued)

## Recommended Signal List

ENGLISH

- The following are recommended for use with this monitor (RGB input):

No.	Signal mode			Horizontal frequency (Hz)	Dot clock frequency (Hz)	Remarks
	Signal name	Resolution	Vertical frequency (Hz)			
1	VGA	640 X 400	70.08	31.47	25.18	
2		640 X 480	59.94	31.47	25.18	
3	VESA	640 X 480	72.81	37.86	31.50	
4		640 X 480	75.00	37.50	31.50	
5		800 X 600	56.25	35.16	36.00	
6		800 X 600	60.32	37.88	40.00	
7		800 X 600	72.19	48.08	50.00	
8		800 X 600	75.00	46.88	49.50	
9		1024 X 768	60.00	48.36	65.00	
10		1024 X 768	70.07	56.48	75.00	
11		1024 X 768	75.03	60.02	78.75	
12		1280 X 1024	60.02	63.98	108.00	
13		1280 X 1024	75.03	79.98	135.00	Full display only
14	Apple	640 X 480	66.67	35.00	30.24	
15		832 X 624	74.55	49.73	57.28	
16		1024 X 768	74.93	60.24	80.00	

- The type of video board or connecting cable used may not allow for correct displays Set H.POSITION, V.POSITION, CLOCK and PHASE.
- The monitor may fail to display an animation image correctly when a signal having a vertical frequency of 60 Hz or higher is input to it.
- The monitor differentiates the signal modes according to the horizontal and vertical frequencies and the horizontal and vertical sync signal polarities. Note that different signals having all these elements alike may be handled as the same signal.
- Displaying images with more than 512 lines of vertical resolution at Full display (compressed display) can result in the interpolation of stripes. Take care that especially Full displays with a resolution of 1280 x 1024 can result in a completely black or white screen, depending on the pattern.
- Use of this monitor with the input signal timings specified below is recommended. A predefined setting may not be reproduced correctly with an extremely long front porch or back porch or with an extremely short data display time.

		Front porch	Sync width	Back porch	Blanking width
Horizontal timing	Horizontal frequency 24 kHz to 52 kHz	0.1 μs or more	1.0-3.8 μs	1.2 μs or more	3.5 μs or more
	Horizontal frequency 52 kHz to 80 kHz	0.1 μs or more	0.8-3.0 μs	1.1 μs or more	2.3 μs or more
Vertical timing		9 μs or more	100 μs or more	400 μs or more	450 μs or more

## **Marantz America, Inc.**

---

440 Medinah Road  
Roselle, IL 60172

Telephone : 630-307-3100  
Fax : 630-307-2687