

# marantz®

## Model PD5001 User Guide

---

Plasma Monitor

# IMPORTANT SAFETY INSTRUCTIONS

## Read before operating equipment

1. Read these instructions.
2. Keep these instructions.
3. Heed all warnings.
4. Follow all instructions.
5. Do not use this apparatus near water.
6. Clean only with a dry cloth.
7. Do not block any of the ventilation openings. Install in accordance with the manufacturer's instructions.
8. Do not install near any heat sources such as radiators, heat registers, stoves, or other apparatus (including amplifiers) that produce heat.
9. Do not defeat the safety purpose of the polarized or grounding-type plug. A polarized plug has two blades with one wider than the other. A grounding type plug has two blades and third grounding prong. The wide blade or third prong are provided for your safety. If the provided plug does not fit into your outlet, consult an electrician for replacement of the obsolete outlet.
10. Protect the power cord from being walked on or pinched particularly at plugs, convenience receptacles, and the point where they exit from the apparatus.
11. Only use attachments/accessories specified by the manufacturer.
12.  Use only with the cart, stand, tripod, bracket, or table specified by the manufacturer, or sold with the apparatus. When a cart is used, use caution when moving the cart/apparatus combination to avoid injury from tip-over.
13. Unplug this apparatus during lightning storms or when unused for long periods of time.
14. Refer all servicing to qualified service personnel. Servicing is required when the apparatus has been damaged in any way, such as power-supply cord or plug is damaged, liquid has been spilled or objects have fallen into the apparatus, the apparatus has been exposed to rain or moisture, does not operate normally, or has been dropped.

### (Additional Safety Information)

15. This product may contain lead or mercury. Disposal of these materials may be regulated due to environmental considerations.  
For disposal or recycling information, please contact your local authorities or the Electronic Industries Alliance: [www.eiae.org](http://www.eiae.org).
16. **Damage Requiring Service** - The appliance should be serviced by qualified service personnel when:
  - A. The power supply cord or the plug has been damaged; or
  - B. Objects have fallen, or liquid has been spilled into the appliance; or
  - C. The appliance has been exposed to rain; or
  - D. The appliance does not appear to operate normally or exhibits a marked change in performance; or
  - E. The appliance has been dropped, or the enclosure damaged.
17. **Tilt/Stability** - All televisions must comply with recommended international global safety standards for tilt and stability properties of its cabinets design.
  - Do not compromise these design standards by applying excessive pull force to the front, or top, of the cabinet which could ultimately overturn the product.
  - Also, do not endanger yourself, or children, by placing electronic equipment/toys on the top of the cabinet. Such items could unsuspectingly fall from the top of the set and cause product damage and/or personal injury.
18. **Wall Mounting** - The appliance should be mounted to a wall only as recommended by the manufacturer.
19. **Power Lines** - An outdoor antenna should be located away from power lines.
20. **Outdoor Antenna Grounding** - If an outside antenna is connected to the receiver, be sure the antenna system is grounded so as to provide some protection against voltage surges and built up static charges. Section 810 of the National Electric Code, ANSI/NFPA No. 70- 1984, provides information with respect to proper grounding of the mats and supporting structure grounding of the lead-in wire to an antenna-discharge unit, size of grounding connectors, location of antenna-discharge unit, connection to grounding electrodes and requirements for the grounding electrode.
21. **Objects and Liquid Entry** - Care should be taken so that objects do not fall and liquids are not spilled into the enclosure through openings.

Apparatus shall not be exposed to dripping or splashing and that no objects filled with liquids, such as vases, shall be placed on apparatus.

### WARNING

To reduce the risk of fire or electric shock, do not expose this apparatus to rain or moisture.

# PRÉCAUTIONS IMPORTANTES DE SÉCURITÉ

## A lire avant de faire fonctionner l'appareil

1. Lire ces instructions.
2. Garder ces instructions.
3. Respecter tous les avertissements.
4. Suivre toutes les instructions.
5. Ne pas utiliser cet appareil près de l'eau.
6. Nettoyer seulement avec un chiffon sec.
7. Ne pas boucher les ouvertures d'aération. Installer selon les instructions du fabricant.
8. Ne pas installer près d'une source de chaleur telle qu'un radiateur, une bouche de chauffage, une cuisinière ou d'autre matériel (y compris des amplificateurs) qui produit de la chaleur.
9. Ne pas contourner la sécurité fournie par la fiche polarisée ou la fiche de mise à la terre. Une fiche polarisée possède deux lames dont une plus large que l'autre. Une fiche de mise à la terre possède deux lames et une broche de mise à la terre. La lame large ou la broche est fournie pour votre sécurité. Si la fiche fournie ne va pas dans la prise, demander à un électricien de remplacer la prise démodée.
10. Protéger le cordon d'alimentation en ne pas marchant dessous ni le coinçant, en particulier près des fiches, des prises et de l'endroit où le cordon rejoint de l'appareil.
11. N'utiliser que des accessoires préconisés par le fabricant.
12.  Utiliser seulement avec le chariot, meuble, trépied, support ou table spécifié par le fabricant ou vendu avec l'appareil. En utilisant un chariot, au moment de déplacer le chariot/téléviseur, bien faire attention pour éviter des blessures dues au renversement éventuel.
13. Débrancher cet appareil pendant des orages ou lorsqu'il ne sera pas utilisé pendant longtemps.
14. Consulter un technicien agréé de service après vente pour toute réparation.  
Le service après vente est nécessaire lorsque l'appareil a été endommagé de quelque façon que ce soit, telle que lorsque le cordon d'alimentation ou la fiche est endommagé, du liquide renversé, un objet tombé dans l'appareil, l'exposition de l'appareil à la pluie ou l'humidité, lorsque l'appareil ne fonctionne pas normalement ou lorsqu'on a laissé tomber l'appareil.

### (Informations de Sécurité Supplémentaires)

15. Ce produit peut contenir un plomb ou du mercure. La mise à rebut de ces matières pourrait être réglementée pour des raisons de protection de l'environnement. Pour s'informer sur la mise à rebut ou le recyclage, veuillez se mettre en contact avec les autorités locales ou l'Electronic Industries Alliance: [www.eiae.org](http://www.eiae.org).
16. **Dommages qu'il faut faire réparer** - Il faut faire réparer l'appareil par un technicien qualifié lorsque:
  - A. Le cordon d'alimentation en électricité ou la fiche a été endommagé; ou
  - B. On a laissé tomber des objets ou du liquide dans l'appareil;
  - C. On a exposé l'appareil à la pluie; ou
  - D. L'appareil ne paraît pas marcher normalement ou présente de grands changements d'opération; ou
  - E. On a laissé tomber l'appareil ou endommager le coffret.
17. Tous les téléviseurs doivent être conformes aux normes inter-nationales de sécurité préconisées pour les propriétés de stabilité et d'inclinaison dans la conception des meubles.
  - Ne pas compromettre ces normes de conception en tirant excessivement sur le devant ou le haut du meuble, ce qui risque éventuellement de renverser le produit.
  - De plus, ne pas se mettre en danger, ni mettre les enfants en danger en plaçant du matériel électronique ou des jouets sur le meuble. De tels articles pourraient tomber malencontreusement du haut du téléviseur et endommager le produit et/ou blesser des gens.
18. **Montage au mur ou au plafond** - Il faut monter l'appareil à un mur ou plafond uniquement en suivant les recommandations du fabricant.
19. **Lignes de transmission** - Il faut situer une antenne extérieure à l'écart des lignes de transmission d'électricité.
20. **Mise à terre de l'antenne extérieure** - Si une antenne extérieure est reliée au récepteur, assurez-vous que le système d'antenne est bien mis à la terre pour protéger contre les sauts de tension et l'accumulation des charges d'électricité statique.  
La section 810 du National Electric Code, ANSI/NFPA No. 70-1984, fournit des renseignements sur la mise à la terre du mât et de sa structure de soutien, du fil d'entrée à un appareil de décharge/antenne, sur la grosseur des conducteurs de mise à terre, sur l'emplacement d'un appareil de décharge/antenne, sur la mise à la terre vers les électrodes de terre, ainsi que sur les recommandations sur les électrodes de terre.
21. **Entrée des objets et des liquides** - Evitez de laisser tomber des objets ou des liquides par les ouverture de l'enclos.

Ne pas exposer l'appareil aux projections ou aux écoulement d'eau et ne jamais poser un récipient contenant du liquide, un vase par exemple, sur l'appareil.





### AVERTISSEMENT

Pour réduire les risques d'incendie ou d'électrocution, ne jamais exposer cet appareil à la pluie ou à l'humidité.

# Important Information

## Precautions

Please read this manual carefully before using your plasma monitor and keep the manual handy for future reference.

	<b>CAUTION</b> RISK OF ELECTRIC SHOCK DO NOT OPEN	
<p><b>CAUTION:</b> TO REDUCE THE RISK OF ELECTRIC SHOCK, DO NOT REMOVE COVER. NO USER-SERVICEABLE PARTS INSIDE. REFER SERVICING TO QUALIFIED SERVICE PERSONNEL.</p>		
	<p>This symbol warns the user that uninsulated voltage within the unit may have sufficient magnitude to cause electric shock. Therefore, it is dangerous to make any kind of contact with any part inside of this unit.</p>	
	<p>This symbol alerts the user that important literature concerning the operation and maintenance of this unit has been included. Therefore, it should be read carefully in order to avoid any problems.</p>	

<b>WARNING</b>
<p>TO PREVENT FIRE OR SHOCK HAZARDS, DO NOT EXPOSE THIS UNIT TO RAIN OR MOISTURE. ALSO DO NOT USE THIS UNIT'S POLARIZED PLUG WITH AN EXTENSION CORD RECEPTACLE OR OTHER OUTLETS, UNLESS THE PRONGS CAN BE FULLY INSERTED. REFRAIN FROM OPENING THE CABINET AS THERE ARE HIGH-VOLTAGE COMPONENTS INSIDE. REFER SERVICING TO QUALIFIED SERVICE PERSONNEL.</p>

## Warnings and Safety Precaution

This plasma monitor is designed and manufactured to provide long, trouble-free service. No maintenance other than cleaning is required. Please see the section "Plasma monitor cleaning procedure".

The plasma display panel consists of fine picture elements (cells) with more than 99.99 percent active cells. There may be some cells that do not produce light or remain lit. For operating safety and to avoid damage to the unit, read carefully and observe the following instructions.

To avoid shock and fire hazards:

1. Provide adequate space for ventilation to avoid internal heat build-up. Do not cover rear vents or install the unit in a closed cabinet or shelves.  
If you install the unit in an enclosure, make sure there is adequate space at the top of the unit to allow hot air to rise and escape. If the monitor becomes too hot, the overheat protector will be activated and the monitor will be turned off. If this happens, turn off the power to the monitor and unplug the power cord. If the room where the monitor is installed is particularly hot, move the monitor to a cooler location, and wait for 60 minutes to cool the monitor. If the problem persists, contact your dealer for service.
2. Do not use this unit's polarized plug with extension cords or outlets unless the prongs can be completely inserted.
3. Do not expose the unit to water or moisture.
4. Avoid damage to the power cord, and do not attempt to modify the power cord.
5. Unplug the power cord during electrical storms or if the unit will not be used over a long period.
6. Do not open the cabinet which has potentially dangerous high voltage components inside. If the unit is damaged in this way the warranty will be void. Moreover, there is a serious risk of electric shock.
7. Do not attempt to service or repair the unit. The manufacturer is not liable for any bodily harm or damage caused if unqualified persons attempt service or open the back cover. Refer all service to authorized Service Centers.
8. This equipment shall be connected to a MAIN outlet with a protective earth-ground connection.
9. The outlet shall be installed near the equipment and shall be easily accessible.

To avoid damage and prolong operating life:

1. Use only with 100 V to 240 V 50 Hz/60 Hz AC power supply. Continued operation at line voltages greater than 100 V to 240 V AC will shorten the life of the unit, and might even cause a fire hazard.
2. Handle the unit carefully when installing it and do not drop.
3. Set the unit away from heat, excessive dust, and direct sunlight.
4. Protect the inside of the unit from liquids and small metal objects. In case of accident, unplug the power cord and have it serviced by an authorized Service Center.
5. Do not hit or scratch the panel surface as this causes flaws on the surface of the screen.
6. For correct installation and mounting it is strongly recommended to use a trained, authorized dealer.
7. As is the case with any phosphor-based display (like a CRT monitor, for example) light output will gradually decrease over the life of a Plasma Display Panel.
8. To avoid sulfurization it is strongly recommended not to place the unit in a dressing room in a public bath or hot spring bath.
9. Do not use in a moving vehicle, as the unit could drop or topple over and cause injuries.
10. Do not place the unit on its side, upside-down or with the screen facing up or down, to avoid combustion or electric shock.
11. To prevent a fire hazard, do not place any naked flame sources (such as a lighted candle) on the equipment.

Plasma monitor cleaning procedure:

1. Use a soft dry cloth to clean the front panel and bezel area. Never use solvents such as alcohol or thinner to clean these surfaces.
2. Clean plasma ventilation areas with a vacuum cleaner with a soft brush nozzle attachment.
3. To ensure proper ventilation, cleaning of the ventilation areas must be carried out monthly. More frequent cleaning may be necessary depending on the environment in which the plasma monitor is installed.

Recommendations to avoid or minimize image retention:

Like all phosphor-based display devices and all other gas plasma displays, plasma monitors can be susceptible to image retention under certain circumstances. Certain operating conditions, such as the continuous display of a static image over a prolonged period of time, can result in image retention if proper precautions are not taken. To protect your investment in this plasma monitor, please adhere to the following guidelines and recommendations for minimizing the occurrence of image retention:

- \* Always enable and use your computer's screen saver function during use with a computer input source.
- \* Display a moving image whenever possible.
- \* Change the position of the menu display from time to time.
- \* Always power down the monitor when you are finished using it.

If the plasma monitor is in long term use or continuous operation take the following measures to reduce the likelihood of image retention:

- \* Lower the Brightness and Contrast levels as much as possible without impairing image readability.
- \* Display an image with many colors and color gradations (i.e. photographic or photo-realistic images).
- \* Create image content with minimal contrast between light and dark areas, for example white characters on black backgrounds. Use complementary or pastel color whenever possible.
- \* Avoid displaying images with few colors and distinct, sharply defined borders between colors.

Plasma monitor driving sound

The panel of the Plasma monitor is composed of extremely fine pixels and these pixels emit light according to received video signals. This principle may cause you to hear a buzz or electrical hum coming from the Plasma monitor. Also note that the rotation speed of the cooling fan motor increases when the ambient temperature of the Plasma monitor becomes high. You may hear the sound of the motor at that time.

### Note:

The following items are not covered by the warranty.

- Image retention
- Panel generated sound, examples: Fan motor noise, and electrical circuit humming /glass panel buzzing.

Contact your dealer for other recommended procedures that will best suit your particular application needs.

# Recommandations importantes

## Précaution

Veillez lire avec attention ce manuel avant d'utiliser le moniteur à plasma et le conserver accessible pour s'y référer ultérieurement.



**ATTENTION**  
RISQUE D'ELECTROCUTION  
NE PAS OUVRIR



**ATTENTION:** POUR EVITER TOUT RISQUE D'ELECTROCUTION, NE PAS OUVRIR LE BOITIER. A L'INTERIEUR, AUCUNE PIECE NE NECESSITE L'INTERVENTION DE L'UTILISATEUR. EN CAS DE PROBLEME, S'ADRESSER A UN REPARATEUR SPECIALISTE.



Ce symbole est une mise en garde contre les risques d'électrocution que présentent certaines parties dépourvues d'isolation à l'intérieur de l'appareil. Il est donc dangereux d'établir le moindre contact avec ces parties.



Ce symbole avertit l'utilisateur que d'importantes informations sont fournies sur le fonctionnement ou l'entretien de cet appareil. De ce fait, il faut lire attentivement ces instructions pour éviter tout problème.

## AVERTISSEMENT

AFIN D'EVITER TOUT RISQUE D'INCENDIE OU D'ELECTROCUTION, NE PAS EXPOSER CET APPAREIL A LA PLUIE OU A L'HUMIDITE. NE PAS BRANCHER LA PRISE D'ALIMENTATION POLARISEE DANS UNE PRISE MURALE AVEC UNE RALLONGE OU UN ADAPTATEUR MULTIPRISE SI LES FICHES NE PEUVENT ETRE INSEREES COMPLETEMENT. EVITER D'OUVRIR LE BOITIER CAR CELUI-CI PROTEGE DES COMPOSANTS FONCTIONNANT A HAUTE TENSION. EN CAS DE PROBLEME, S'ADRESSER A UN REPARATEUR SPECIALISTE.

## Avertissements et précautions de sécurité

Ce moniteur à plasma a été conçu et fabriqué pour une utilisation fiable et durable. Il ne nécessite aucun entretien en dehors du nettoyage. Voir la section "Méthode de nettoyage du moniteur à plasma" plus loin.

Le panneau à affichage plasma est constitué de fines particules d'images (cellules) dont plus de 99,99 % sont actives. Certaines d'entre elles ne produisent pas de lumière ou restent allumées.

Pour des raisons de sécurité et pour éviter d'endommager l'appareil, lire attentivement les instructions suivantes.

Pour éviter les risques d'électrocution et d'incendie:

1. Laisser suffisamment d'espace autour de l'appareil pour la ventilation et éviter toute augmentation excessive de la température interne. Ne pas couvrir les fentes d'aération ou installer l'appareil dans un endroit trop exigu.  
Si vous installez l'appareil dans un espace clos, assurez-vous qu'il y ait suffisamment d'espace au dessus pour permettre l'air chaud de s'élever et de s'évacuer.  
Si la température du moniteur devient excessive, la protection contre les surchauffes entrera en action et coupera l'alimentation. Dans ce cas, éteindre l'appareil et débrancher le câble d'alimentation. Si la température de la pièce dans laquelle se trouve le moniteur est particulièrement élevée, déplacer celui-ci dans un endroit plus frais et attendre environ 60 minutes qu'il refroidisse. Si le problème persiste, prendre contact avec votre revendeur.
2. Ne pas raccorder la prise d'alimentation polarisée de ce périphérique à une rallonge ou une prise murale si les fiches ne peuvent pas être complètement insérées.
3. Ne pas exposer cet appareil à la pluie ou à l'humidité.
4. Eviter d'endommager le câble d'alimentation et ne pas le modifier.
5. Débrancher le câble d'alimentation électrique pendant les orages ou les longues périodes d'inactivité.
6. Ne pas ouvrir le boîtier protégeant les parties dangereuses fonctionnant hauts voltages. Si l'appareil est endommagé de cette manière, la garantie sera annulée. De plus, les risques d'électrocution grave sont grands.
7. Ne pas essayer d'intervenir ou de réparer l'appareil. Le fabricant décline toute responsabilité en cas de blessure corporelle ou de dégâts matériels résultant d'une opération d'entretien quelconque effectuée par des personnes non qualifiées ou résultant de l'ouverture du couvercle arrière. S'adresser au service après-vente autorisé.
8. Cet équipement doit être connecté à une prise secteur (MAIN) équipée d'une mise à la terre.
9. La prise secteur doit se trouver près de l'équipement et doit être facile d'accès.

Pour éviter tout dommage et assurer une utilisation durable:

1. Utiliser seulement une alimentation en courant de 100 V à 240 V 50 Hz/60 Hz. Toute utilisation prolongée avec un courant supérieur à 100 V à 240 V risque de diminuer la durée de vie de l'appareil et même de provoquer un incendie.
2. Manipuler l'appareil avec précautions lors de son installation, ne pas le laisser tomber.
3. L'installer loin de toute source de chaleur ou de poussière. Ne pas l'exposer au soleil.
4. Eviter la pénétration de liquides ou petits objets métalliques l'intérieur de l'appareil. En cas d'incident de ce genre, débrancher le câble d'alimentation électrique et confier le moniteur à un service après-vente agréé.
5. Ne pas cogner ou rayer la surface de l'écran, des déformations de l'image en résulteraient.
6. Pour un montage et une installation correcte, il est fortement recommandé de faire appel à un revendeur agréé et qualifié.
7. Comme c'est le cas pour tout affichage à base de phosphore (comme un moniteur CRT, par exemple), la puissance de lumière baisse graduellement au cours de la vie du panneau d'affichage à plasma.
8. Pour éviter tout risque de sulfuration, il est fortement conseillé de ne pas installer l'appareil dans un vestiaire, un bain public ou un bain de source thermale.
9. Ne pas utiliser dans un véhicule en marche car l'unité pourrait tomber ou glisser et provoquer des blessures.
10. Pour éviter l'inflammation ou les chocs électriques, ne pas placer l'unité sur la tranche, à l'envers ou avec l'écran vers le bas ou vers le haut.
11. Pour éviter les risques d'incendie, ne placez aucune flamme nue (telle qu'une bougie allumée) sur l'appareil.

Méthode de nettoyage du moniteur à plasma:

1. Nettoyer le panneau avant et le cadre en procédant à l'aide d'un chiffon doux et sec. Ne jamais utiliser de solvants du type alcool ou diluant pour le nettoyage de ces surfaces.
2. Nettoyer les prises d'aération du plasma en procédant à l'aide d'une brosse à poils doux fixée à un aspirateur.
3. Pour garantir la bonne ventilation du moniteur, nettoyer les prises d'air tous les mois. Un nettoyage plus fréquent peut s'avérer nécessaire selon les conditions environnantes dans lesquelles le moniteur à plasma est utilisé.

Pour éviter les risques de brûlage du luminophore, les mesures suivantes sont recommandées:

Comme tous les périphériques d'affichage à base luminophore et tous les autres affichages gaz plasma, les moniteurs plasma peuvent être sujets au brûlage du luminophore dans certaines circonstances. Certaines conditions d'utilisation, telles que l'affichage continu d'une image statique pour une durée prolongée, peuvent causer le brûlage du luminophore si aucune précaution n'est prise. Pour protéger votre investissement dans ce moniteur à plasma, veuillez suivre les directives et les conseils suivantes pour minimiser l'occurrence du marquage de l'écran:

- \* S'assurer de mettre en marche et d'utiliser l'économiseur d'écran chaque fois que c'est possible, pendant l'utilisation avec une source d'entrée venant d'un ordinateur.
  - \* Afficher une image en mouvement aussi souvent que possible.
  - \* Changer la position de l'affichage de menu de temps à autre.
  - \* Toujours couper l'alimentation après la fin de l'utilisation du moniteur.
- Si le moniteur à plasma est en usage continu ou de longue durée, prendre les mesures suivantes afin d'éviter l'occurrence le brûlage du luminophore:
- \* Abaisser le niveau de l'image (contraste, luminance) autant que possible, sans faire perdre la lisibilité de l'image.
  - \* Afficher une image avec de nombreuses couleurs et graduations de couleur (par ex. des images photo-graphiques ou photo-réalistes).
  - \* Créer un contenu d'image avec un contraste minimal entre les zones sombres et les zones claires, par exemple des caractères blancs sur un fond noir. Utiliser des couleurs complémentaires ou pastels le plus souvent possible.
  - \* Eviter d'afficher des images avec peu de couleurs et des limites nettes et clairement définies entre les couleurs.

Son de fonctionnement du moniteur plasma

Le panneau du moniteur plasma est composé de pixels extrêmement fins et ces pixels émettent de la lumière en fonction des signaux vidéo reçus. Ce principe peut créer un bourdonnement ou un ronflement électrique venant du moniteur plasma. Veuillez également noter que la vitesse de rotation du ventilateur de refroidissement peut augmenter lorsque la température ambiante du moniteur plasma augmente. Lorsque cela se produit, il est possible que vous entendiez le moteur du ventilateur.

### Remarque:

Les éléments suivants ne sont pas couverts par la garantie.

- Rémanence
- Sons générés par le panneau, par exemple : Bruit du moteur de ventilateur, ronflement du circuit électrique / bourdonnement du panneau de verre.

Contactez un revendeur agréé ou un revendeur de marque pour d'autres procédures qui conviendront le mieux à vos besoins particuliers.



# Important Information

## Warning

Not for use in a computer room as defined in the Standard for the Protection of Electronic Computer/ Data Processing Equipment ANSI/NFPA 75.

This equipment has been tested and found to comply with the limits for a Class B digital device, pursuant to Part 15 of the FCC Rules. These limits are designed to provide reasonable protection against harmful interference in a residential installation. This equipment generates, uses, and can radiate radio frequency energy and, if not installed and used in accordance with the instructions, may cause harmful interference to radio communications. However, there is no guarantee that interference will not occur in a particular installation. If this equipment does cause harmful interference to radio or television reception, which can be determined by turning the equipment off and on, the user is encouraged to try to correct the interference by one or more of the following measures:

- Reorient or relocate the receiving antenna.
- Increase the separation between the equipment and receiver.
- Connect the equipment into an outlet on a circuit different from that to which the receiver is connected.
- Consult the dealer or an experienced radio / TV technician for help.

This Class B digital apparatus complies with Canadian ICES-003.

### NOTE:

When you use an RGB cable (not supplied), use an RGB cable including the ferrite core (not supplied) on both ends of the cable. If you do not this, this monitor will not conform to mandatory FCC standards.

### NOTE:

When you use the power cable (supplied), use the supplied ferrite cores. Set the ferrite cores (supplied) on both ends of the power cable (supplied), and then use the bands (supplied) to fasten the ferrite cores (supplied) to the power cable (supplied). If you do not this, this monitor will not conform to mandatory FCC standards.

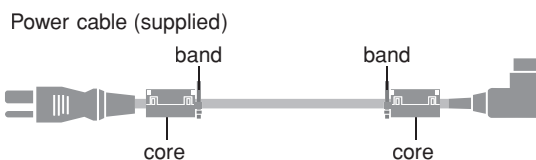

### NOTE:

When you use a remote cable (not supplied), use the supplied ferrite core. Wind the remote cable (not supplied) around the ferrite core (supplied) once, and then fasten the catch. If you do not this, this monitor will not conform to mandatory FCC standards.

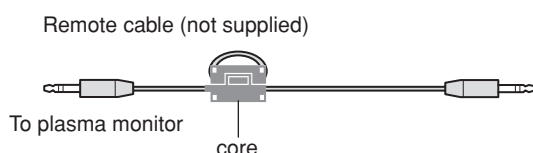

## Caution

This model is for use with the following optional accessories. Use with other optional accessories is capable of resulting in instability causing possible injury.

Manufacturer's name: D&M Holdings Inc.  
Stand: AS4250 for PD5001

Please contact Marantz America, Inc. for approved optional accessories.

### WARNING

This product equipped with a three-wire grounding (earthed) plug - a plug that has a third (grounding) pin. This plug only fits a grounding-type power outlet. If you are unable to insert the plug into an outlet, contact a licensed electrician to replace the outlet with a properly grounded one. Do not defeat the safety purpose of the grounding plug.

### Operating Environment: PD5001

Operating environment temperature and humidity: 0 °C to +40 °C (+32 °F to +104 °F); less than 80 %RH (cooling vents not blocked)

Do not install this unit in a poorly ventilated area, or in locations exposed to high humidity or direct sunlight (or strong artificial light)



### A NOTE ABOUT RECYCLING

This product's packaging materials are recyclable and can be reused. This product and the accessories packed together are the applicable product to the WEEE directive except batteries.

Please dispose of any materials in accordance with your local recycling regulations.

When discarding the unit, comply with your local rules or regulations.

Batteries should never be thrown away or incinerated but disposed of in accordance with your local regulations concerning chemical wastes.

EUROPE ONLY

### CAUTION

When disposing of used batteries, please comply with governmental regulations or environmental public instruction's rules that apply in your country/area.

# Recommandations importantes

## Avertissement

Ne pas utiliser dans une salle d'ordinateurs telle que définie dans la Norme pour la protection des ordinateurs électroniques/appareils de traitement des données ANSI/NFPA75.

Cet appareil a été testé et trouvé conforme avec les limites des appareils numériques de classe B, conformément à l'article 15 du règlement FCC. Ces limites sont conçues pour offrir une protection raisonnable contre les interférences nuisibles dans une installation résidentielle. Cet appareil génère, utilise et peut émettre de l'énergie radiofréquence et, s'il n'est pas installé et utilisé selon les instructions, peut causer des interférences nuisibles aux communications radio. Cependant, il n'y a aucune garantie que de telles interférences ne se produisent pas pour une installation particulière. Si cet appareil causait des interférences nuisibles à la réception radio ou télévisée, ce qui peut être déterminé en mettant l'appareil hors et sous tension, vous êtes encouragé à essayer de corriger ces interférences à l'aide de l'une ou plusieurs mesures suivantes:

- Réorientez ou déplacez l'antenne réceptrice.
- Augmentez l'espace entre l'appareil et le récepteur.
- Connectez l'appareil sur une prise secteur appartenant à un circuit différent de celui sur lequel le récepteur est connecté.
- Consultez votre revendeur ou un technicien radio/télévision expérimenté.

Cet appareil numérique de la classe B est conforme à la norme NMB-003 du Canada.

### REMARQUE :

Lorsque vous utilisez un câble RGB (non fourni), utilisez un câble RGB comprenant une âme en ferrite (non fourni) à ses deux extrémités. Sinon, ce moniteur ne sera pas conforme aux normes FCC obligatoires.

### REMARQUE :

Lorsque vous utilisez le câble d'alimentation (fourni) utilisez les âmes en ferrite fournies. Placez les âmes en ferrite (fournies) aux deux extrémités du câble d'alimentation (fourni) puis utilisez les colliers (fournis) pour fixer les âmes en ferrite (fournies) au câble d'alimentation (fourni). Sinon, ce moniteur ne sera pas conforme aux normes FCC obligatoires.

Câble d'alimentation (fourni)



### REMARQUE :

Lorsque vous utilisez un câble télécommande (non fourni), utilisez l'âme en ferrite fournie. Enroulez le câble télécommande (non fourni) autour de l'âme en ferrite (fournie) une fois, puis serrez la fermeture. Sinon, ce moniteur ne sera pas conforme aux normes FCC obligatoires.

Câble à distance (non fourni)

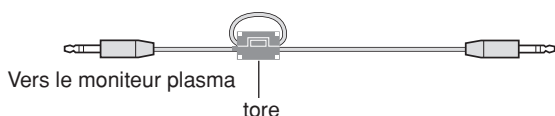

## Attention

Ce modèle peut être utilisé avec les accessoires optionnels suivants. L'utilisation de ce modèle avec d'autres accessoires optionnels peut entraîner une instabilité qui peut causer des blessures.

Nom du fabricant : D&M Holdings Inc.

Support: AS4250 para PD5001

Veillez contacter Marantz America, Inc. pour obtenir la liste des accessoires optionnels agréés.

### AVERTISSEMENT

Cet appareil est muni d'une fiche de mise à la terre (masse) à trois fils. Comme la fiche présente une troisième broche (de terre), elle ne peut se brancher que sur une prise de courant, prévue pour une mise à la terre. Si vous n'arrivez pas à insérer la fiche dans la prise de courant, contactez un électricien qualifié pour faire remplacer la prise par une qui soit mise à la terre. N'annulez pas la fonction de sécurité que procure cette fiche de mise à la terre.

### Milieu de fonctionnement: PD5001

Température et humidité du milieu de fonctionnement: De 0 °C à +40 °C (de +32 °F à +104 °F); Humidité relative inférieure à 80 % (orifices de ventilation non obstrués) N'installez pas l'appareil dans un endroit mal ventilé ou un lieu soumis à une forte humidité ou en plein soleil (ou à une forte lumière artificielle).



### REMARQUE CONCERNANT LE RECYCLAGE

Le matériel d'emballage de cet appareil est recyclable et peut être réutilisé. Cet appareil et les accessoires qui sont emballés avec celui-ci sont conformes, à l'exception des piles, à la directive DEEE (relative aux déchets d'équipements électriques et électroniques).

Jetez ce matériel conformément aux réglementations de recyclage locales.

Pour mettre l'appareil au rebut, respectez les règles ou réglementations locales.

Les piles ne doivent jamais être jetées ou incinérées, mais être mises au rebut conformément aux réglementations locales concernant les déchets chimiques.

L'EUROPE UNIQUEMENT

### ATTENTION

Lorsque vous disposez de piles / batteries usées, veuillez vous conformer aux normes gouvernementales ou environnementales en vigueur dans votre pays ou région.

# Contents

IMPORTANT SAFETY INSTRUCTIONS .....	1
PRÉCAUTIONS IMPORTANTES DE SÉCURITÉ .....	2
Important Information .....	3
Recommandations importantes .....	4
Important Information .....	5
Recommandations importantes .....	6
Contents .....	7
Contents of the Package .....	7
Options .....	7
Installation .....	8
Ventilation Requirements for enclosure mounting .....	8
Cable Management .....	9
Using the remote control .....	9
Battery Installation and Replacement .....	9
Operating Range .....	9
Part Names and Function .....	10
Front View .....	10
Rear View/ Terminal Board .....	12
PD5001 .....	12
Remote Control .....	14
Basic Operations .....	15
POWER .....	15
To turn the unit ON and OFF: .....	15
VOLUME .....	15
To adjust the sound volume: .....	15
MUTE .....	15
To mute the audio: .....	15
DISPLAY .....	15
To check the settings: .....	15
DIGITAL ZOOM .....	15
OFF TIMER .....	15
To set the off timer: .....	15
To check the remaining time: .....	15
To cancel the off timer: .....	15
WIDE Operations .....	16
Wide Screen Operation (manual) .....	16
When viewing videos or digital video discs .....	16
Wide Screen Operation with Computer Signals .....	17
SPLIT SCREEN Operations .....	18
Showing a couple of pictures on the screen at the same time ..	18
Operations in the Side-by-side mode .....	18
Operations in the Picture-in-picture mode .....	19
Selecting the input signals to be displayed .....	19
Zooming in on a specific input .....	19
Adjusting the OSM controls .....	19
OSM (On Screen Menu) Controls .....	20
Menu Operations .....	20
Menu Tree .....	21
Picture Settings Menu .....	23
Storing picture settings .....	23
Adjusting the picture .....	23
Reducing noise in the picture .....	23
Setting the color temperature .....	24
Adjusting the color to the desired level .....	24
Setting the picture to suit the movie .....	24
Setting the picture mode according to the brightness of the room ..	24
Changing the Gamma Curve .....	25
Making the Low Tone adjustments .....	25
Adjusting the pedestal level (black level) .....	25
Adjusting the colors .....	25
Audio Settings Menu .....	26
Adjusting the treble, bass and left/right balance and	
audio input select .....	26
Setting the allocation of the audio and DVD/HD connectors ..	26
Image Adjust Settings Menu .....	26
Adjusting the Position, Size, Fine Picture,	
Picture Adj and Underscan .....	26
SET UP Settings Menu .....	27
Setting the language for the menus .....	27
Checking the signal being transmitted to DVD/HD1 terminal ..	27

Checking the signal being transmitted to PC/RGB terminal ...	27
Setting high definition images to the suitable screen size ...	27
Setting a computer image to the correct RGB select screen ...	27
Setting the black level for HDMI signal .....	28
Setting the video signal format .....	28
Setting the background color when no signal is being input ...	28
Setting the gray level for the sides of the screen .....	29
Setting the screen size for S1/S2 video input .....	29
Turning on/off the menu display .....	29
Setting the position of the menu .....	29
Remote ID .....	30
Resetting to the default values .....	30
Function Settings Menu .....	30
Setting the menu mode .....	30
Setting the power management for computer images .....	30
ON/STANDBY indicator .....	31
Setting the Input Skip .....	31
Removing the sub screen area when there is	
no input signal detected for the sub screen .....	31
Displaying the entire image during	
DIGITAL ZOOM operations .....	31
Displaying still images in the sub screen .....	31
Reducing image retention .....	32
Setting Closed Caption .....	33
Reducing the brightness of Closed Caption .....	34
Setting the power on mode .....	34
Signal Information Menu .....	34
Checking the frequencies, polarities of input signals,	
and resolution .....	34
External Control .....	35
Application .....	35
Connections .....	35
Type of connector: D-Sub 9-pin male .....	35
Communication Parameters .....	35
External Control Codes (Reference) .....	35
Pin Assignments .....	35
mini D-Sub 15-pin connector (Analog) .....	35
1/8 Stereo Mini Jack (not supplied) for REMOTE IN/OUT ...	35
Connection with STB .....	36
Troubleshooting .....	37
Specifications: PD5001 .....	41
Table of Signals Supported .....	42
Supported resolution: PD5001 .....	42
Computer input signals supported by this system .....	42

## Contents of the Package

- Plasma monitor (× 1)
- Power cord (× 1, 3 m/9.8 feet)
- Remote control (× 1)
- AAA Batteries (× 2, Manganese battery for remote control)
- User guide
- Ferrite cores for power cord (× 2), bands for power cord (× 2)
- Ferrite core for remote cable (× 2)
- Cable clampers (× 3), beads bands (× 3)
- Warranty card (× 2)

## Options

- Wall mount unit
- Tilt mount unit
- Tabletop Stand



# Installation

You can attach your optional mounts or stand to the plasma monitor in one of the following two ways:

- \* While it is upright. (See Drawing A)
- \* As it is laid down with the screen face down (See Drawing B). Lay the protective sheet, which was wrapped around the monitor when it was packaged, beneath the screen surface so as not to scratch the screen face.
- \* Do not touch or hold the screen face when carrying the unit.

- **This device cannot be installed on its own. Be sure to use a stand or original mounting unit. (Wall mount unit, Stand, etc.)**
- **For correct installation and mounting it is strongly recommended to use a trained, authorized dealer.**  
**Failure to follow correct mounting procedures could result in damage to the equipment or injury to the installer.**  
**Product warranty does not cover damage caused by improper installation.**

## CAUTION

- **Install the device following the manual of the optional unit.**
- **Install the device on the stable and even place where it is strong enough to stand the weight.**
- **Use the specified clasps for installing.**
- **After installation, make sure to take measurements to prevent falling.**
- **Make sure to move or install the device with another person(s).**

\* Use only a mounting kit or stand recommended by the manufacturer and listed as an accessory.

Drawing A

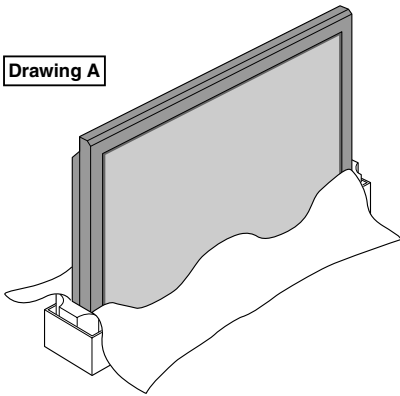

Drawing B

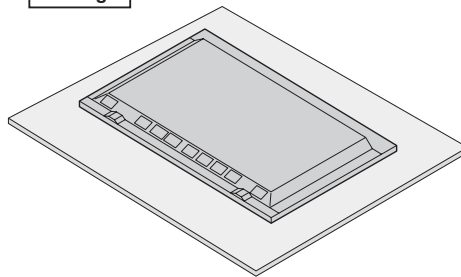

## Ventilation Requirements for enclosure mounting

To allow heat to disperse, leave space between surrounding objects as shown on the diagram when installing.

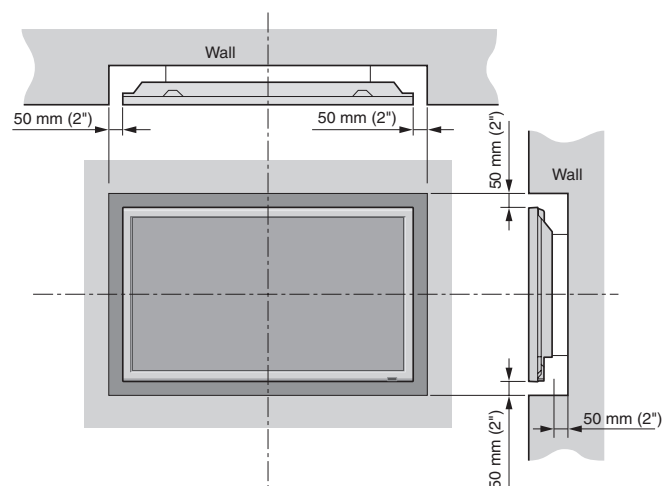

## Cable Management

Using the cable clampers and beads bands provided with the plasma display; Bundle the signal and audio cables at the back of the unit to connect to the display.

PD5001

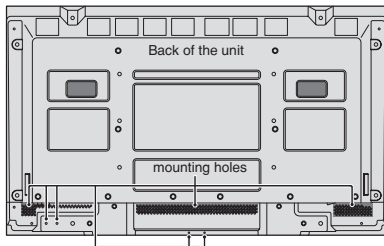

### To attach

Insert ① into a mounting hole, then snap ② into the back of ① to fix the clammer.

Clampers are designed to be difficult to undo once in place. Please attach carefully. Cables can be routed to the right or left.

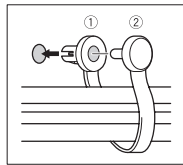

Bunch separated cables together and secure them with the provided beads bands.

Do not allow excessive stress to be placed on the ends of cables.

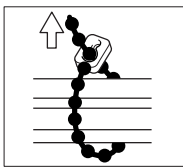

### To detach

Using pliers, twist the clammer 90° and pull it outward. In some cases the clammer may have deteriorated over time and may get damaged when removed.

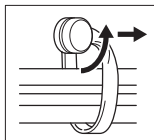

## Using the remote control

### Battery Installation and Replacement

Designated batteries:

Please use size AAA (R03) or AAA (LR03).

Insert the 2 “AAA” batteries, making sure to set them in with the proper polarity.

1. Press and open the cover.

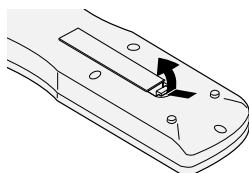

2. Align the batteries according to the ⊕ and ⊖ indication inside the case.

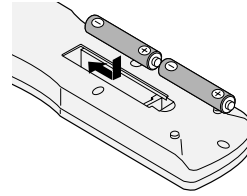

3. Replace the cover.

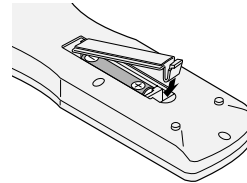

## Operating Range

\* Use the remote control within a distance of about 7 m/ 23 ft. from the front of the monitor’s remote control sensor and at horizontal and vertical angles of up to approximately 30°.

\* The remote control operation may not function if the monitor’s remote control sensor is exposed to direct sunlight or strong artificial light, or if there is an obstacle between the sensor and the remote control.

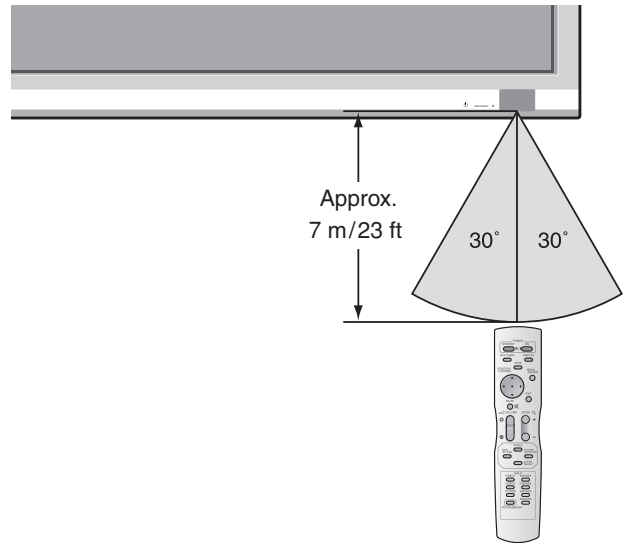

### CAUTION

- Use only the specified batteries.
- Make sure to insert the batteries correctly according to the indications of ⊕ and ⊖ .
- Do not drop or mishandle the remote control.
- Do not get the remote control wet. If the remote control gets wet, wipe it dry immediately.
- Avoid heat and humidity.
- When not using the remote control for a long period, remove the batteries.
- Do not use new and old batteries together, or use different types together.
- Do not take apart the batteries, heat them, or throw them into a fire.

# Part Names and Function

## Front View

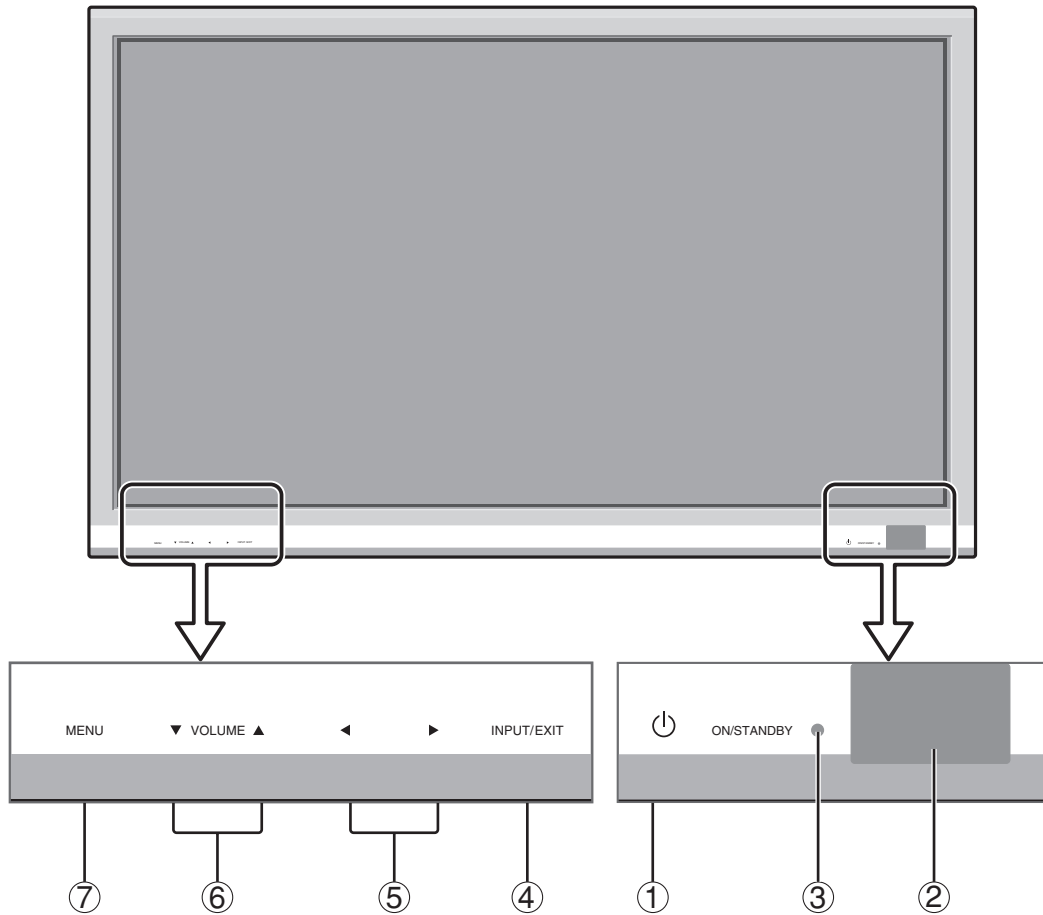

- ① **Power**  
Turns the monitor's power on and off.
- ② **Remote sensor window**  
Receives the signals from the remote control.
- ③ **ON/STANDBY indicator**  
When the power is on ..... Lights green.  
When the power is in the standby mode ... Lights red.
- ④ **INPUT / EXIT**  
Switches the input.  
Functions as the EXIT buttons in the On-Screen Menu (OSM) mode.
- ⑤ **◀ and ▶**  
Enlarges or reduces the image. Functions as the CURSOR (◀/▶) buttons in the On-Screen Menu (OSM) mode.
- ⑥ **VOLUME ▼ and ▲**  
Adjusts the volume. Functions as the CURSOR (▼/▲) buttons in the On-Screen Menu (OSM) mode.
- ⑦ **MENU**  
Sets the On-Screen Menu (OSM) mode and displays the main menu.

### **WARNING**

The Power on/off switch does not completely disconnect power from the display.

## Rear View/ Terminal Board

PD5001

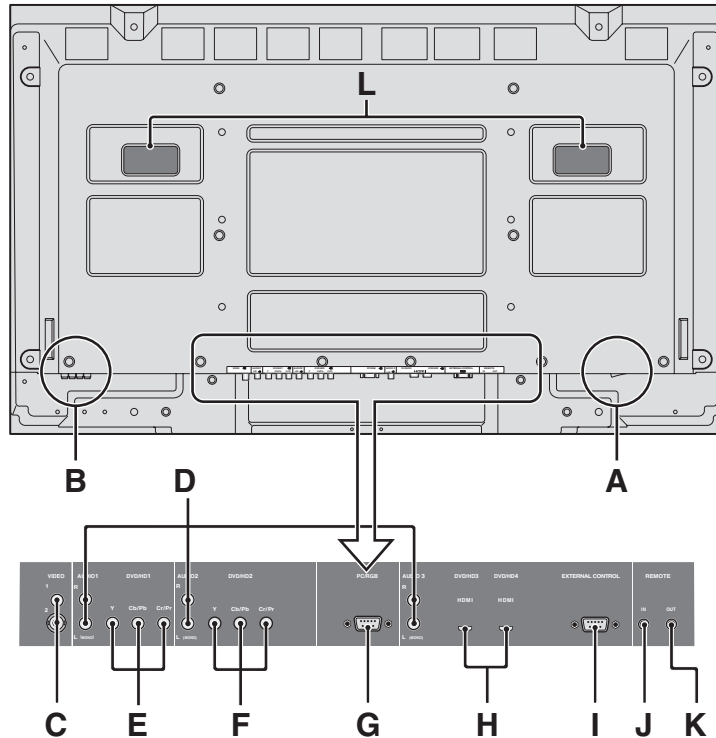

### A AC IN

Connect the included power cord here.

### B EXT SPEAKER L and R

Connect speakers (optional) here. Maintain the correct polarity. Connect the  $\oplus$  (positive) speaker wire to the  $\oplus$  EXT SPEAKER terminal and the  $\ominus$  (negative) speaker wire to the  $\ominus$  EXT SPEAKER terminal on both LEFT and RIGHT channels.

Please refer to your speaker's owner's manual.

### C VIDEO1, 2 (RCA, S-Video)

Connect VCR's, DVD's or Video Cameras, etc. here.

### D AUDIO1, AUDIO2, AUDIO3

These are audio input terminals.

The input is selectable. Set which video image corresponds to the audio input from the audio menu screen.

### E DVD/HD1

Connect DVD's, High Definition or Laser Discs, etc. here.

### F DVD/HD2

You can connect DVDs, High Definition sources, Laser Discs, etc. here.

### G PC/RGB (D-Sub)

Connect an analog RGB signal from a computer, etc. here.

### H DVD/HD3, DVD/HD4 (HDMI)

Connect a digital signal from a source with a HDMI output. See "Specifications" on "Model Information".

### I EXTERNAL CONTROL (D-Sub)

This terminal is used when operating and controlling the monitor externally with a control system (by RS-232C).

### J REMOTE IN

### K REMOTE OUT

Use these terminals to control external equipment.

### L Handles

Use when installing or carrying the plasma monitor.

**HDMI**<sup>TM</sup>  
HIGH-DEFINITION MULTIMEDIA INTERFACE

HDMI, the HDMI logo and High-Definition Multimedia Interface are trademarks or registered trademarks of HDMI Licensing LLC.

## Remote Control

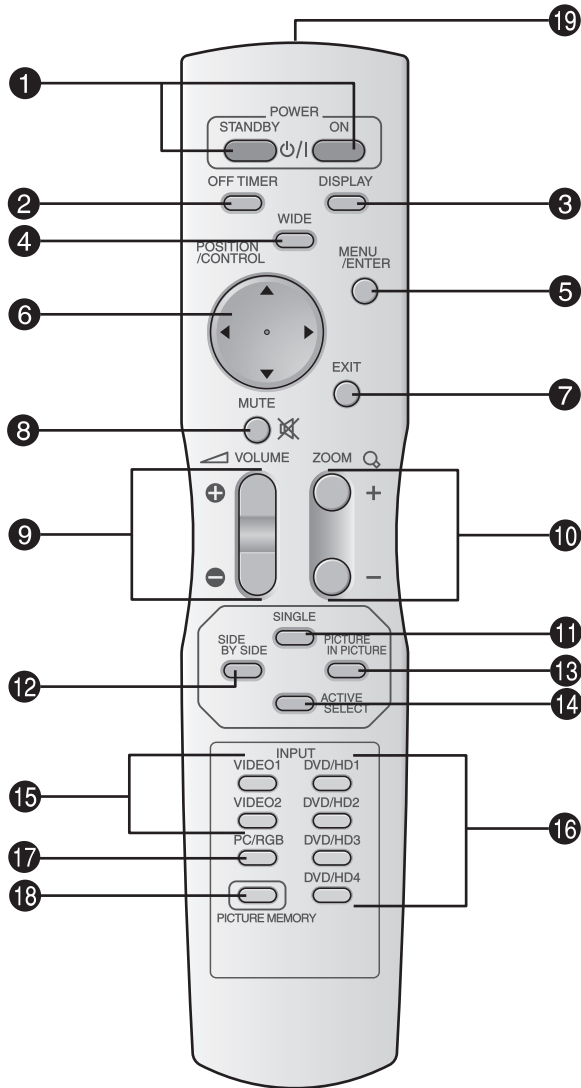

### 1 POWER ON/STANDBY

Switches the power on/standby.  
(This does not operate when the ON/STANDBY indicator of the plasma is off.)

### 2 OFF TIMER

Activates the off timer for the unit.

### 3 DISPLAY

Displays the source settings on the screen.

### 4 WIDE

Automatically detects the signal and sets the aspect ratio.

WIDE button is not active for all signals.

### 5 MENU/ENTER

Press this button to access the OSM controls.  
Press this button during the display of the main menu to go to the sub menu.

### 6 CURSOR (▲ / ▼ / ◀ / ▶)

Use these buttons to select items or settings and to adjust settings or switch the display patterns.

### 7 EXIT

Press this button to exit the OSM controls in the main menu. Press this button during the display of the sub menu to return to the previous menu.

### 8 MUTE

Mutes the audio.

### 9 VOLUME (+ /-)

Adjusts the audio volume.

### 10 ZOOM (+ /-)

Enlarges or reduces the image.

### 11 SINGLE

Cancels the split screen mode.

### 12 SIDE BY SIDE

Press this button to show a couple of pictures in the side-by-side mode.

### 13 PICTURE IN PICTURE

Press this button to show a couple of pictures in the picture-in-picture mode.

### 14 ACTIVE SELECT

Press this button to make the desired picture activate during split screen mode.  
When the PICTURE FREEZE function is operating, this button can be used to display still images on the sub screen.

### 15 VIDEO1, 2

Press this button to select VIDEO as the source.  
VIDEO can also be selected using the INPUT/EXIT button on the monitor.

### 16 DVD/HD1, 2, 3, 4

Press this button to select DVD/HD as the source.  
DVD/HD can also be selected using the INPUT/EXIT button on the monitor.

### 17 PC/RGB

Press this button to select PC/RGB as the source.  
PC/RGB can also be selected using the INPUT/EXIT button on the monitor.

### 18 PICTURE MEMORY

Switches sequentially between picture memory settings 1 to 6.

### 19 Remote control signal transmitter

Transmits the remote control signals.



# Basic Operations

## POWER

### To turn the unit ON and OFF:

1. Plug the power cord into an active AC power outlet.
2. Press the Power button (on the unit).  
The monitor's ON/STANDBY indicator turns red and the standby mode is set.
3. Press the POWER ON button (on the remote control) to turn on the unit.  
The monitor's ON/STANDBY indicator will light up (green) when the unit is on.
4. Press the POWER STANDBY button (on the remote control) or the Power button (on the unit) to turn off the unit.  
The monitor's ON/STANDBY indicator turns red and the standby mode is set (only when turning off the unit with the remote control).

## VOLUME

### To adjust the sound volume:

1. Press and hold the VOLUME ⊕ button (on the remote control or the unit) to increase to the desired level.
2. Press and hold the VOLUME ⊖ button (on the remote control or the unit) to decrease to the desired level.

## MUTE

### To mute the audio:

Press the MUTE button on the remote control to mute the audio; press again to restore.

## DISPLAY

### To check the settings:

1. The screen changes each time the DISPLAY button is pressed.
2. If the button is not pressed for approximately three seconds, the menu turns off.

## DIGITAL ZOOM

Digital zoom specifies the picture position and enlarges the picture.

1. (Be sure ZOOM NAV is off.)  
Press the ZOOM (+ or -) button to display magnifying glass. ( 🔍 )

### To change the size of the picture:

Press the ZOOM+ button and enlarge the picture.  
A press of the ZOOM- button will reduce the picture and return it to its original size.

### To change the picture position:

1. Select the position with the ▲▼◀▶ buttons.
2. Press the EXIT button to delete the pointer.

## OFF TIMER

### To set the off timer:

The off timer can be set to turn the power off after 30, 60, 90 or 120 minutes.

1. Press the OFF TIMER button to start the timer at 30 minutes.
2. Press the OFF TIMER button to the desired time.
3. The timer starts when the menu turns off.

→ 30 → 60 → 90 → 120 → 0

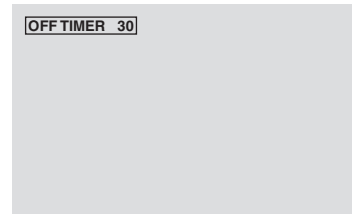

### To check the remaining time:

1. Once the off timer has been set, press the OFF TIMER button once.
2. The remaining time is displayed, then turns off after a few seconds.
3. When five minutes remain the remaining time appears until it reaches zero.

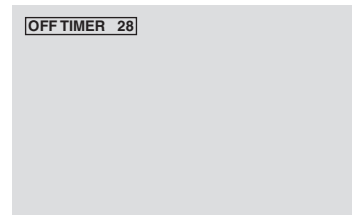

### To cancel the off timer:

1. Press the OFF TIMER button twice in a row.
2. The off timer is canceled.



### Note:

*After the power is turned off with the off timer ... A slight current is still supplied to the monitor. When you are leaving the room or do not plan to use the system for a long period of time, turn off the power to the monitor.*

# WIDE Operations

## Wide Screen Operation (manual)

With this function, you can select one of seven screen sizes.

### When viewing videos or digital video discs

1. Press the WIDE button on the remote control.
2. *Within 3 seconds ...*

Press the WIDE button again.

The screen size switches as follows:

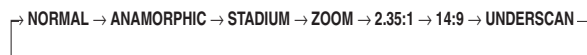

When a 720P or 1080I signal is input:

ANAMORPHIC ↔ 2.35:1

When displaying enhanced split screen:

NORMAL ↔ ANAMORPHIC

### NORMAL size screen (4:3)

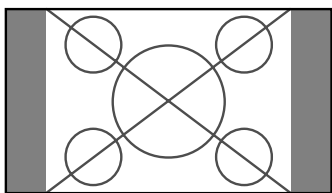

The normal size screen is displayed.

\* The picture has the same size as video pictures with a 4 : 3 aspect ratio.

### ANAMORPHIC size screen

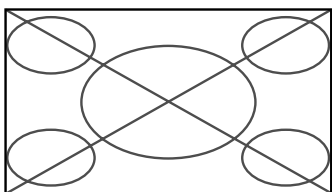

The image is expanded in the horizontal direction.

\* Images compressed in the horizontal direction ("squeezed images") are expanded in the horizontal direction and displayed on the entire screen with correct linearity. (Normal images are expanded in the horizontal direction.)

### STADIUM size screen

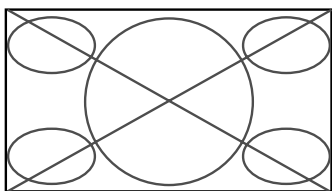

The picture is expanded in the horizontal and vertical directions at different ratios.

\* Use this for watching normal video programs (4:3) with a wide screen.

### ZOOM size screen

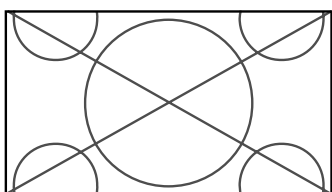

The picture is expanded in the horizontal and vertical direction, maintaining the original proportions.

\* Use this for theater size (wide) movies, etc.

### 2.35:1 size screen

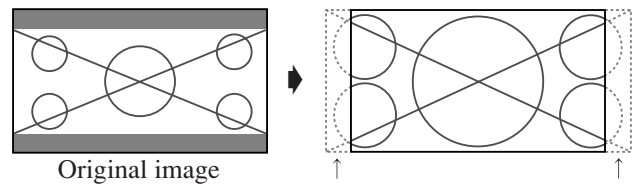

Information is lost on both sides.

The squeezed film image is expanded to fulfill the entire screen at a ratio of 2.35:1. Black bands do not appear at the top and bottom but information is lost on the left and right margins.

• This feature is available when the input signal is video, component (480I, 480P, 576I, 576P, 720P, 1080I) or RGB (525P or 625P signal from a scan converter).

\* If black bands appear on the top and bottom in the full size screen, select the 2.35:1 size screen to fill the screen and avoid image retention.

### 14:9 size screen

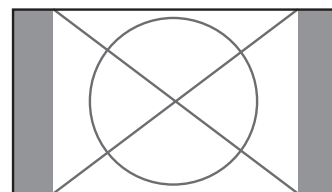

The image is displayed at a 14:9 aspect ratio.

\* This feature is available when the input signal is video, component (480I, 480P, 576I, 576P) or RGB (525P or 625P signal from a scan converter).

### UNDERSCAN size screen

Set "UNDERSCAN" to "ON" in the "IMAGE ADJUST".

Typical televisions crop the image (i.e., overscan). In order to restore the entire image, select UNDERSCAN.

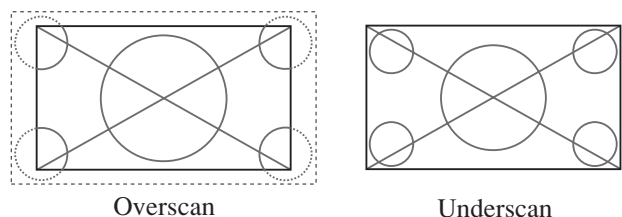

\* Picture noise or black border may appear near the edge of screen depending on the connected component.

\* The continuous display in this screen size over a prolonged period of time may result in image retention.

\* When Macrovision signal is input, the brightness may change.

### Note:

Do not allow 4:3 content to be displayed for extended periods of time without using gray bars. This can cause image retention.

## Wide Screen Operation with Computer Signals

Switch to the wide screen mode to expand the 4 : 3 image to fill the entire screen.

1. Press the WIDE button on the remote control.
2. *Within 3 seconds ...*

Press the WIDE button again.

The screen size switches as follows:

→ NORMAL → ANAMORPHIC → ZOOM →

When displaying enhanced split screen:

NORMAL ↔ ANAMORPHIC

NORMAL size screen (4:3 or SXGA 5:4)

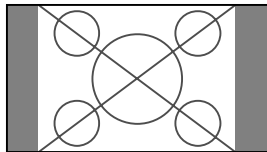

The picture has the same size as the normal computer image.

ANAMORPHIC size screen

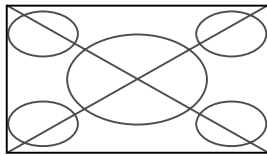

The image is expanded in the horizontal direction.

ZOOM size screen

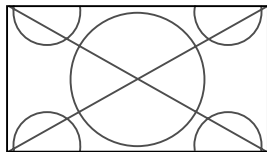

When wide signals are input.

ANAMORPHIC size screen

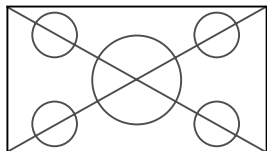

### Information

#### ■ Supported resolution

See page 39, 42 and 45 for details on the display output of the various VESA signal standards supported by the monitor.

■ **When 852 (848) dot × 480 line wide VGA\* signals with a vertical frequency of 60 Hz and horizontal frequency of 31.7 (31.0) kHz are input**

Select an appropriate setting for RGB SELECT mode referring to the “Table of Signals Supported” on page 39, 42 and 45.

\* “VGA”, “SVGA” and “SXGA” are registered trademarks of IBM, Inc. of the United States.

#### **Note:**

*Do not allow 4:3 content to be displayed for extended periods of time without using gray bars. This can cause image retention.*

# SPLIT SCREEN Operations

## Showing a couple of pictures on the screen at the same time

\* There may be some RGB-input signals that may not be displayed as not all signals are supported.

1. Press the button to select a screen mode from among single mode, side-by-side, and picture-in-picture.

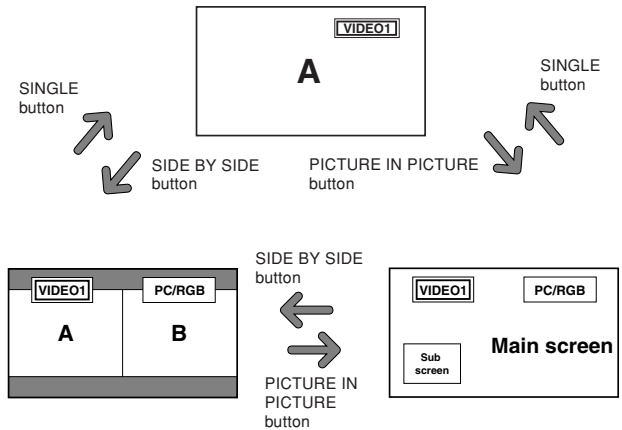

**Note:**  
Picture A and B on the above screen are not always of the same height.

**Information**  
Split screen operations may not function depending on the combination of input signals. In the table below, "○" means Yes, "×" means No.

		Pictures displayed on the right/main screen (Select1)						
		VIDEO1	VIDEO2	DVD/HD1	DVD/HD2	DVD/HD3	DVD/HD4	PC/RGB
Pictures displayed on the left/sub screen (Select2)	VIDEO1	×	×	○	○	○	○	○
	VIDEO2	×	×	○	○	○	○	○
	DVD/HD1	○	○	×	○	○	○	○
	DVD/HD2	○	○	○	×	○	○	○
	DVD/HD3	○	○	○	○	×	×	○
	DVD/HD4	○	○	○	○	×	×	○
	PC/RGB	○	○	○	○	○	○	×

■ Split screen operations may not function depending on the frequency of the RGB signals.

## Operations in the Side-by-side mode

To change the picture size, press the cursor ◀▶ or ▼ button.

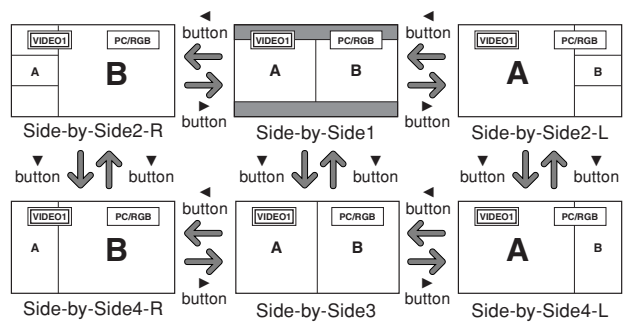

To swap the picture on the right and the left, press the cursor ▲ button.

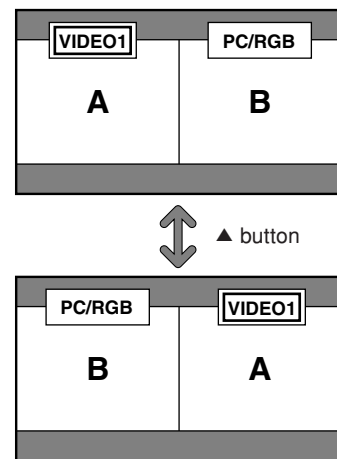

To make the desired picture active, press the ACTIVE SELECT button.

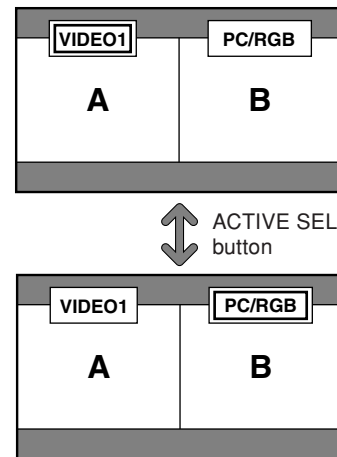

## Operations in the Picture-in-picture mode

To move the position of the sub screen, press the cursor ◀ or ▶ button.

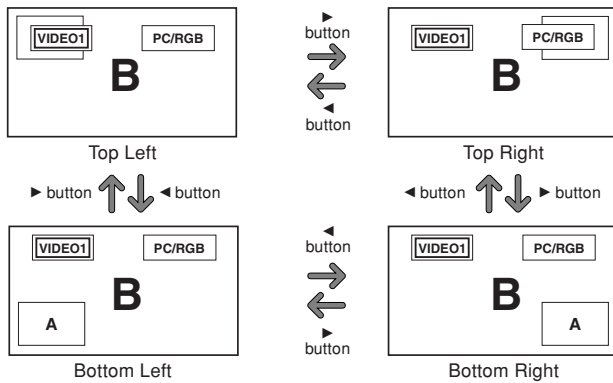

To change the size of the sub screen, press the ▼ button.

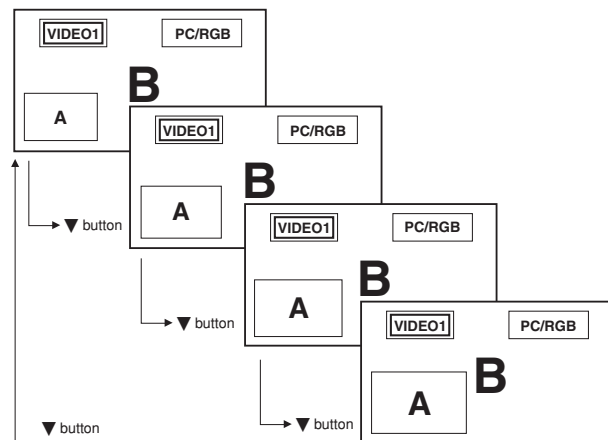

To make the desired picture active, press the ACTIVE SELECT button.

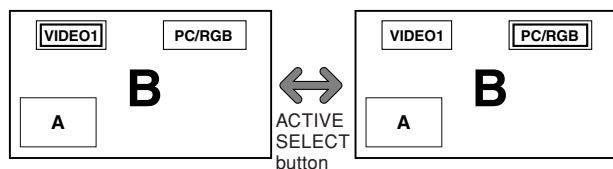

## Selecting the input signals to be displayed

1. Press the ACTIVE SELECT button to make the desired picture active.
2. Press the PC/RGB, VIDEO1, 2 or DVD/HD1, 2, 3, 4 button to change the selection of the input signal. The INPUT/EXIT button on the monitor can also be used to change the selection.

## Zooming in on a specific input

1. Press the ACTIVE SELECT button to make the desired picture active.
2. Use the ZOOM (+ or -) button to enlarge the picture. For details, see "DIGITAL ZOOM" on page 15.

## Adjusting the OSM controls

1. Press the ACTIVE SELECT button to make the desired picture active.
2. Press the MENU/ENTER button to display the MAIN MENU.
3. Adjust the setting to your preference. For details, see "OSM (On Screen Menu) Controls" on page 20.

### Note:

*During enhanced split screen, some functions of OSM controls are not available.*



# OSM (On Screen Menu) Controls

## Menu Operations

The following describes how to use the menus and the selected items.

1. Press the MENU/ENTER button on the remote control to display the MAIN MENU.

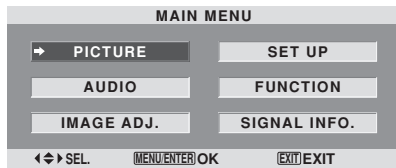

2. Press the cursor buttons ▲ ▼ on the remote control to highlight the menu you wish to enter.
3. Press the MENU/ENTER button on the remote control to select a sub menu or item.

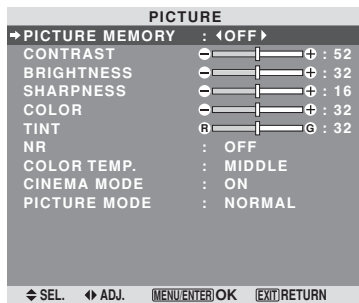

4. Adjust the level or change the setting of the selected item by using the cursor buttons ◀ ▶ on the remote control.

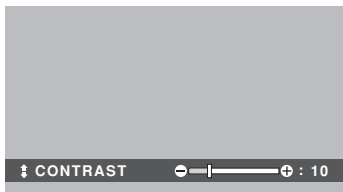

5. The adjustments or settings are then stored in memory. The change is stored until another change is made.
6. Repeat steps 2 – 5 to adjust an additional item, or press the EXIT button on the remote control to return to the main menu.

\* When adjusting using the bar at the bottom of the screen, press the ◀ or ▶ button within 5 seconds. If not, the current setting is stored and the previous screen appears.

**Note:** The main menu disappears by pressing the EXIT button.

## Information

### Advanced menu mode

When “ADVANCED OSM” is set to “ON” in the FUNCTION menu, full menu items will be shown.

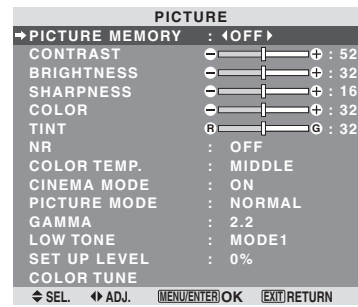

\* The actual screen may be different from the ones in this manual.

## Menu Tree

■ : Shaded areas indicate the default value.

←→+ : Press the ◀ or ▶ button to adjust.

▭ : Menu items in a ruled box are available when the ADVANCED OSM is set to ON.

Main menu	Sub menu	Sub menu 2	Sub menu 3	Sub menu 4	RESET	REFERENCE	
PICTURE	PICTURE MEMORY	OFF/MEMORY1-6			YES	23	
	CONTRAST	←→+ 0←52→72			YES	23	
	BRIGHTNESS	←→+ 0←32→64			YES	23	
	SHARPNESS	←→+ 0←16→32			YES	23	
	COLOR	←→+ 0←32→64			YES	23	
	TINT	R←→G 0←32→64			YES	23	
	NR	OFF/NR-1/NR-2/NR-3			YES	23	
	COLOR TEMP.	LOW/MIDDLE LOW/MIDDLE/HIGH			YES	24	
	WHITE BALANCE	GAIN RED	←→+ 0←40→70			YES	24
		GAIN GREEN	←→+ 0←40→70			YES	24
		GAIN BLUE	←→+ 0←40→70			YES	24
		BIAS RED	←→+ 0←40→70			YES	24
		BIAS GREEN	←→+ 0←40→70			YES	24
		BIAS BLUE	←→+ 0←40→70			YES	24
		RESET	OFF←→ON			YES	24
		CINEMA MODE	ON←→OFF			YES	24
	PICTURE MODE	DEFAULT/THEATER1/THEATER2/NORMAL/BRIGHT			YES	24	
	<u>GAMMA</u>	2.1←→2.2←→2.3←→2.4			YES	25	
	<u>LOW TONE</u> *3	MODE1←→MODE2			YES	25	
	<u>SET UP LEVEL</u>	0%←→3.75%←→7.5%			YES	25	
	<u>COLOR TUNE</u>	RED	Y←→M 0←32→64			YES	25
		GREEN	C←→Y 0←32→64			YES	25
		BLUE	M←→C 0←32→64			YES	25
		YELLOW	G←→R 0←32→64			YES	25
		MAGENTA	R←→B 0←32→64			YES	25
		CYAN	B←→G 0←32→64			YES	25
		RESET	OFF←→ON			YES	25

Main menu	Sub menu	Sub menu 2	Sub menu 3	Sub menu 4	RESET	REFERENCE
AUDIO	BASS	←→+ 0←13→26			YES	26
	TREBLE	←→+ 0←13→26			YES	26
	BALANCE	L←→R -22←0→+22			YES	26
	AUDIO INPUT1	VIDEO 1-2 / DVD/HD 1-4 / PC/RGB			YES	26
	AUDIO INPUT2	VIDEO 1-2 / DVD/HD 1-4 / PC/RGB			YES	26
	AUDIO INPUT3	VIDEO 1-2 / DVD/HD 1-4 / PC/RGB			YES	26
	DVD/HD3 INPUT	INPUT 1-3 / HDMI			YES	26
	DVD/HD4 INPUT	INPUT 1-3 / HDMI			YES	26

Main menu	Sub menu	Sub menu 2	Sub menu 3	Sub menu 4	RESET	REFERENCE
IMAGE ADJ.	ASPECT MODE	ZOOM/NORMAL/ANAMORPHIC/STADIUM/14.9:2.35:1/UNDERSCAN			—	26
	V-POSITION	←→+ -64←0→+64			YES	26
	H-POSITION	←→+ -128←0→+127			YES	26
	V-HEIGHT	←→+ 0←→64			YES	26
	H-WIDTH	←→+ 0←→64			YES	26
	AUTO PICTURE	ON←→OFF*2			NO	26
	FINE PICTURE*1	←→+ *2 0←→64			YES	26
	PICTURE ADJ.*1	←→+ *2 0←→64			YES	26
<u>UNDERSCAN</u>	ON←→OFF			YES	26	

Main menu	Sub menu	Sub menu 2	Sub menu 3	Sub menu 4	RESET	REFERENCE
SET UP	LANGUAGE	ENGLISH/DEUTSCH/FRANÇAIS/ESPAÑOL/ITALIANO/SVENSKA/РУССКИЙ/PORTUGUÊS			NO	27
	<u>DVD/HD1 INPUT</u>	COMPONENT			YES	27
	<u>D-SUB INPUT</u>	RGB			YES	27
	<u>HD SELECT</u>	1080i/1035i/540P			NO	27
	<u>RGB SELECT</u>	AUTO			YES	27
	<u>HDMI SET UP</u>	LOW←→HIGH			NO	28
	<u>COLOR SYSTEM</u>	AUTO/3.58NTSC/4.43 NTSC/PAL/PAL 60/PAL-N/PAL-M/SECAM			NO	28
	<u>BACK GROUND</u>	BLACK/GRAY			YES	28
	<u>GRAY LEVEL</u>	0←→3←→15			YES	29
	<u>S1/S2</u>	AUTO←→OFF			YES	29
	<u>DISPLAY OSM</u>	ON←→OFF			YES	29
	<u>OSM ADJ.</u>	TOP LEFT←→TOP CENTER←→TOP RIGHT←→BTM LEFT←→BTM CENTER←→BTM RIGHT			YES	29
	<u>REMOTE ID</u>	ALL←→1←→4			YES	30
	ALL RESET	ON←→OFF			—	30

Main menu	Sub menu	Sub menu 2	Sub menu 3	Sub menu 4	RESET	REFERENCE	
FUNCTION	ADVANCED OSM	ON↔OFF			YES	30	
	POWER MGT.	ON↔OFF			YES	30	
	INPUT SKIP	ON↔OFF			YES	31	
	SUB. PICTURE	SUB. P DETECT	OFF↔AUTO			YES	31
		DISPLAY	FADE↔NORMAL			YES	31
		SUB. P RATE	20%↔100%			YES	31
		ZOOM NAV	OFF↔S BY S↔BTM LEFT↔BTM RIGHT↔TOP RIGHT↔TOP LEFT			YES	31
		PICTURE FREEZE	OFF↔S BY S1↔S BY S2↔BTM LEFT↔BTM RIGHT↔TOP RIGHT↔TOP LEFT			YES	31
	PDP SAVER	MANUAL/AUTO	PEAK BRIGHT	100%/75%/50%/25%		YES	32
			ORBITER	OFF/AUTO1/AUTO2		YES	32
			INVERSE/WHITE	OFF/INVERSE/WHITE		YES	33
			SCREEN WIPER	ON/OFF		YES	33
			SOFT FOCUS	OFF/LEVEL1-4		YES	33
			OSM ORBITER	ON/OFF		YES	33
			OSM CONTRAST	LOW/NORMAL		YES	33
		CLOSED CAPTION	OFF/CAPTION1-4/TEXT1-4			YES	33
		CAPTION CONT	LOW/NORMAL			YES	34
		PWR. ON MODE	INPUT	LAST / VIDEO 1-2 / DVD/HD 1-4 / PC/RGB / MULTI			YES
	VOLUME		LAST↔0↔42			YES	34

Main menu	Sub menu	Sub menu 2	Sub menu 3	Sub menu 4	RESET	REFERENCE
SIGNAL INFO.					—	34

\*1 Only when AUTO PICTURE is OFF.

\*2 PC/RGB only

\*3 “LOW TONE” is only for 50 inch type.

### Information

#### ■ Restoring the factory default settings

Select “ALL RESET” under the SET UP menu. Note that this also restores other settings to the factory defaults.

## Picture Settings Menu

### Storing picture settings

This function allows you to store in memory the current input signal and PICTURE menu settings and to recall these settings when necessary.

There are six picture memories, and notes of up to 15 characters can be added to each.

Example: Storing picture settings at MEMORY1

On "PICTURE MEMORY" of "PICTURE" menu, select "MEMORY1", then press the MENU/ENTER button.

The "PICTURE MEMORY" screen appears.

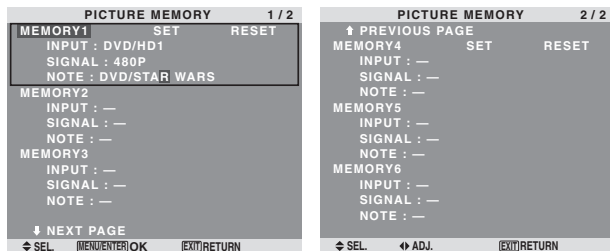

#### Information

##### PICTURE MEMORY Settings

OFF: Picture memory not used.

MEMORY1 to 6: Picture memory with the specified number used. Maximum memories are 6, not depending on inputs.

##### Setting the memory

- Use the ▲ and ▼ button to select the desired memory place, MEMORY1 to MEMORY6.
- Use the ◀ and ▶ buttons to select "SET", then press the MENU/ENTER button.
- If necessary, input a note.

##### Resetting the memory

Use the ▲ and ▼ button to select the desired memory place, MEMORY1 to MEMORY6, then use the ◀ and ▶ buttons to select "RESET", and finally press the MENU/ENTER button.

The memory is cleared, and "—" is displayed in the "INPUT", "SIGNAL" and "NOTE" columns.

##### Inputting notes

- Use the ◀ and ▶ buttons to select "NOTE", then press the MENU/ENTER button.
- Input the note.
  - Use the ▲ and ▼ button to select the character.
  - Use the ◀ and ▶ buttons to move the cursor.
  - Use the EXIT button to delete the character at the cursor position.
- When you have finished inputting the note, press the MENU/ENTER button.

## Adjusting the picture

The contrast, brightness, sharpness, color and tint can be adjusted as desired.

Example: Adjusting the contrast

On "CONTRAST" of "PICTURE" menu, adjust the contrast.

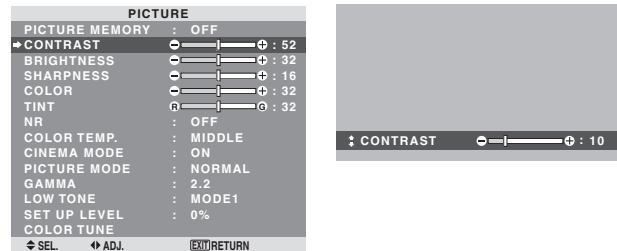

**Note:** If "CAN NOT ADJUST" appears ...

When trying to enter the PICTURE submenu, make sure PICTURE MODE is not set to DEFAULT.

#### Information

##### Picture adjustment screen

CONTRAST: Changes the picture's white level.

BRIGHTNESS: Changes the picture's black level.

SHARPNESS: Changes the picture's sharpness. Adjusts picture detail of VIDEO display.

COLOR: Changes the color density.

TINT: Changes the picture's tint. Adjust for natural colored skin, background, etc.

##### Adjusting the computer image

Only the contrast and brightness can be adjusted when a computer signal is connected.

##### Restoring the factory default settings

Select "DEFAULT" under the "PICTURE MODE" settings.

## Reducing noise in the picture

Use these settings if the picture has noise due to poor reception or when playing video tapes on which the picture quality is poor.

Example: Setting "NR-3"

On "NR" of "PICTURE" menu, select "NR-3".

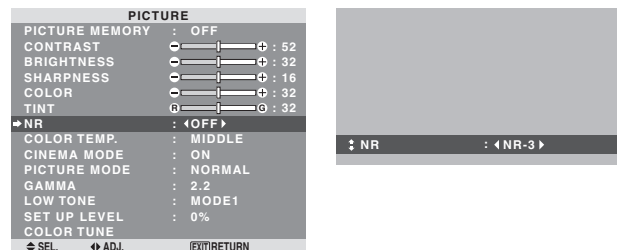

#### Information

##### NR

\* "NR" stands for Noise Reduction.

\* This function reduces noise in the picture.

##### Types of noise reduction

There are three types of noise reduction. Each has a different level of noise reduction.

The effect becomes stronger as the number increases (in the order NR-1 → NR-2 → NR-3).

OFF: Turns the noise reduction function off.

## Setting the color temperature

Use this procedure to set color tone produced by the plasma display.

Example: Setting "HIGH"

On "COLOR TEMP." of "PICTURE" menu, select "HIGH".

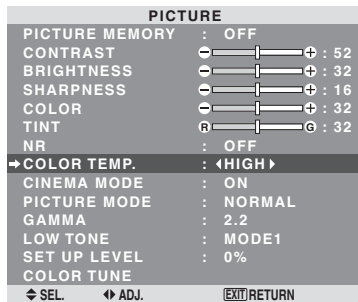

### Information

#### ■ Setting the color temperature

LOW: More red

MIDDLE LOW: Slightly red

MIDDLE: Standard (slightly bluer)

HIGH: More blue

## Adjusting the color to the desired level

Use this procedure to adjust the white balance for each color temperature to achieve the desired color quality.

Example: Adjusting the "GAIN RED" of "HIGH" color temperature

On "COLOR TEMP." of "PICTURE" menu, select "HIGH", then press the MENU/ENTER button.

The "WHITE BALANCE" screen appears.

On "GAIN RED", adjust the white balance.

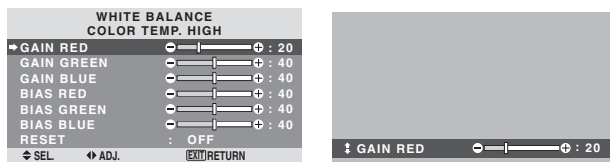

### Information

#### ■ Adjusting the white balance

GAIN R/G/B: White balance adjustment for white level

BIAS R/G/B: White balance adjustment for black level

RESET: Resets settings to the factory default values.

Use ◀ and ▶ buttons to select "ON", then press the MENU/ENTER button.

#### ■ Restoring the factory default settings

Select "RESET" under the WHITE BALANCE menu.

## Setting the picture to suit the movie

The film image is automatically discriminated and projected in an image mode suited to the picture.

[NTSC, PAL, PAL60, 480I (60 Hz), 525I (60 Hz), 576I (50 Hz), 625I (50 Hz), 1035I (60 Hz), 1080I (60 Hz) only]

Example: Setting the "CINEMA MODE" to "OFF"

On "CINEMA MODE" of "PICTURE" menu, select "OFF".

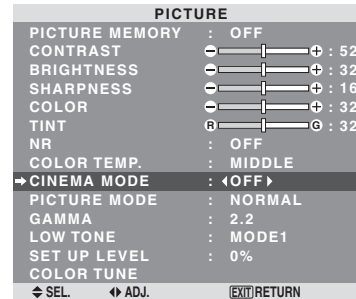

### Information

#### ■ CINEMA MODE

ON: Automatic discrimination of the image and projection in cinema mode.

OFF: Cinema mode does not function.

## Setting the picture mode according to the brightness of the room

There are four picture modes that can be used effectively according to the environment in which you are viewing the display.

Example: Setting the "THEATER1" mode

On "PICTURE MODE" of "PICTURE" menu, select "THEATER1".

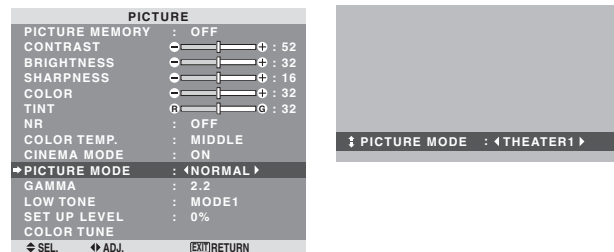

### Information

#### ■ Types of picture modes

THEATER1, 2: Set this mode when watching video in a dark room.

This mode provides darker, finer pictures, like the screen in movie theaters.

For a darker image, select THEATER2.

NORMAL: Set this mode when watching video in a bright room.

BRIGHT: This mode provides brighter pictures than NORMAL.

This mode provides dynamic pictures with distinct differences between light and dark sections.

DEFAULT: Use this to reset the picture to the factory default settings.

ISF-DAY and ISF-NIGHT: This mode is displayed only when an ISF dealer performs a maintenance. Please contact Marantz America, Inc. for details.



## Changing the Gamma Curve

This feature adjusts the brightness of the midtone areas while keeping shadows and highlights unchanged.

Example: Setting "2.3"

Set "ADVANCED OSM" to "ON" in the FUNCTION menu.

On "GAMMA" of "PICTURE" menu, select "2.3".

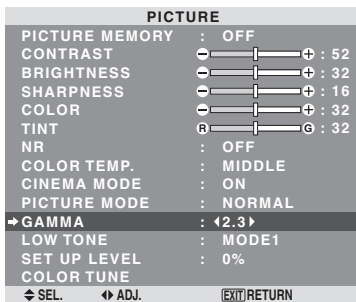

### Information

#### ■ GAMMA settings

The picture becomes darker as the number increases (in the sequence of 2.1, 2.2, 2.3, 2.4).

\* These values are approximate.

## Making the Low Tone adjustments

You can select the tone reproduction from 2 modes. This function is effective especially for dark images.

\* This function is available only for 50 inch type.

Example: Setting "MODE2"

Set "ADVANCED OSM" to "ON" in the FUNCTION menu.

On "LOW TONE" of "PICTURE" menu, select "MODE2".

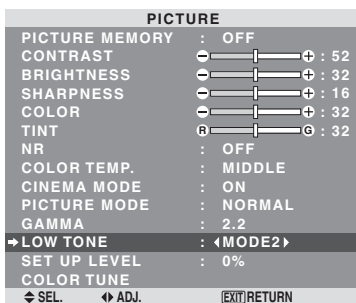

## Adjusting the pedestal level (black level)

This feature adjusts the video black level in a video image.

Example: Setting "3.75%"

Set "ADVANCED OSM" to "ON" in the FUNCTION menu.

On "SET UP LEVEL" of "PICTURE" menu, select "3.75%".

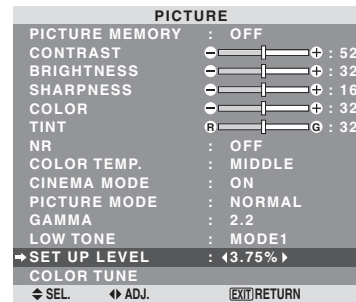

### Information

#### ■ SET UP LEVEL settings

0%: Normal status

3.75%: 3.75 % lower than normal

7.5%: 7.5 % lower than normal

## Adjusting the colors

Use this procedure to adjust hue and color density for red, green, blue, yellow, magenta and cyan without changing the white point.

You can accentuate the green color of trees, the blue of the sky, etc.

Example: Adjusting the color tune for blue

Set "ADVANCED OSM" to "ON" in the FUNCTION menu.

On "PICTURE" menu, select "COLOR TUNE", then press the MENU/ENTER button.

The "COLOR TUNE" screen appears.

On "BLUE" of "COLOR TUNE", adjust the color tune.

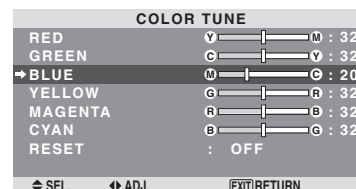

### Information

#### ■ COLOR TUNE settings

RED: Adjusts hue of Red

GREEN: Adjusts hue of Green

BLUE: Adjusts hue of Blue

YELLOW: Adjusts hue of Yellow

MAGENTA: Adjusts hue of Magenta

CYAN: Adjusts hue of Cyan

RESET: Resets settings to the factory default value.

Use ◀ and ▶ buttons to select "ON", then press the MENU/ENTER button.

## Audio Settings Menu

### Adjusting the treble, bass and left/right balance and audio input select

The treble, bass and left/right balance can be adjusted to suit your tastes.

Example: Adjusting the bass

On "BASS" of "AUDIO" menu, adjust the bass.

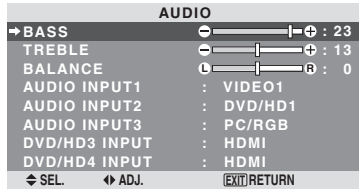

**Note :** If "CAN NOT ADJUST" appears...  
Set "AUDIO INPUT" on the AUDIO menu correctly.

#### Information

##### ■ Audio settings menu

**BASS:** Controls the level of low frequency sound.  
**TREBLE:** Controls the level of high frequency sound.  
**BALANCE:** Controls the balance of the left and right channels.

### Setting the allocation of the audio and DVD/HD connectors

Setting the AUDIO1-3 and DVD/HD3-4 connectors to the desired input.

Example: Setting "AUDIO INPUT1" to "VIDEO2"

On "AUDIO INPUT1" of "AUDIO" menu, select "VIDEO2".

The available sources depend on the settings of input.

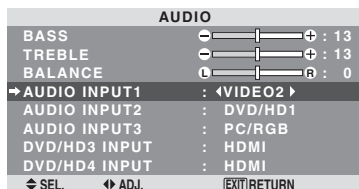

#### Information

An input cannot be selected as the channel for more than one input terminal.

## Image Adjust Settings Menu

### Adjusting the Position, Size, Fine Picture, Picture Adj and Underscan

The position of the image can be adjusted and flickering of the image can be corrected.

Example: Adjusting the vertical position in the normal mode

On "V-POSITION" of "IMAGE ADJUST" menu, adjust the position.

The mode switches as follows each time the ◀ or ▶ button is pressed:

**NORMAL** ↔ **ANAMORPHIC**

\* The mode can also be switched by pressing the WIDE button on the remote control.

\* The settings on the IMAGE ADJUST menu are not preset at the factory.

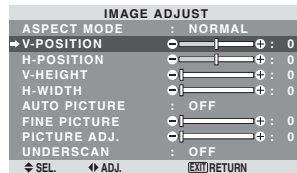

#### Information

##### ■ When "AUTO PICTURE" is "OFF"

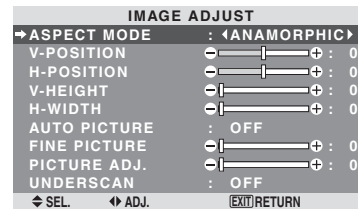

When Auto Picture is off, the Fine Picture and the Picture ADJ. items are displayed so that you can adjust them.

##### ■ Adjusting the Auto Picture

**ON:** The Picture ADJ., Fine Picture and Position adjustments are made automatically.

Not available for digital ZOOM.

**OFF:** The Picture ADJ., Fine Picture and Position adjustments are made manually.

\* If FINE PICTURE can't be adjusted, set Auto Picture to OFF and adjust manually.

##### ■ Adjusting the position of the image

**V-POSITION:** Adjusts the vertical position of the image.

**H-POSITION:** Adjusts the horizontal position of the image.

**V-HEIGHT:** Adjusts the vertical size of the image. (Not available for STADIUM mode)

**H-WIDTH:** Adjusts the horizontal size of the image. (Not available for STADIUM mode)

**FINE PICTURE\*:** Adjusts for flickering.

**PICTURE ADJ.\*:** Adjusts for striped patterns on the image (i.e. vertical banding).

\* The Picture ADJ. and Fine Picture features are available only when the "Auto Picture" is off.

\* The AUTO PICTURE, FINE PICTURE and PICTURE ADJ. are available only for PC/RGB signals.

But, these features are not available for moving pictures on VIDEO, DVD/HD or PC/RGB.

##### ■ Setting the Underscan

Set "ADVANCED OSM" to "ON" in the FUNCTION menu.

**ON:** UNDERSCAN can be selected in ASPECT MODE.

**OFF:** UNDERSCAN cannot be selected in ASPECT MODE.

\* Selectable only when video signal is input.

## SET UP Settings Menu

### Setting the language for the menus

The menu display can be set to one of eight languages.

Example: Setting the menu display to "DEUTSCH"

On "LANGUAGE" of "SET UP" menu, select "DEUTSCH".

SET UP	
→ LANGUAGE	: <DEUTSCH>
DVD/HD1 INPUT	: COMPONENT
D-SUB INPUT	: RGB
HD SELECT	: 1080I
RGB SELECT	: AUTO
HDMI SET UP	: HIGH
COLOR SYSTEM	: AUTO
BACK GROUND	: GRAY
GRAY LEVEL	: 3
S1/S2	: OFF
DISPLAY OSM	: ON
OSM ADJ.	: TOP LEFT
REMOTE ID	: ALL
ALL RESET	: OFF
◀ SEL.	▶ ADJ. [EXIT] RETURN

#### Information

##### ■ Language settings

ENGLISH .....	English	ITALIANO .....	Italian
DEUTSCH .....	German	SVENSKA .....	Swedish
FRANÇAIS .....	French	РУССКИЙ .....	Russian
ESPAÑOL .....	Spanish	PORTUGUÊS .....	Portuguese

### Checking the signal being transmitted to DVD/HD1 terminal

Set "ADVANCED OSM" to "ON" in the FUNCTION menu.

Use this to confirm the signal being transmitted to DVD/HD1 terminal.

It is set to COMPONENT and can not be adjusted.

SET UP	
LANGUAGE	: ENGLISH
→ DVD/HD1 INPUT	: COMPONENT
D-SUB INPUT	: RGB
HD SELECT	: 1080I
RGB SELECT	: AUTO
HDMI SET UP	: HIGH
COLOR SYSTEM	: AUTO
BACK GROUND	: GRAY
GRAY LEVEL	: 3
S1/S2	: OFF
DISPLAY OSM	: ON
OSM ADJ.	: TOP LEFT
REMOTE ID	: ALL
ALL RESET	: OFF
CAN NOT ADJUST	

### Checking the signal being transmitted to PC/RGB terminal

Set "ADVANCED OSM" to "ON" in the FUNCTION menu.

Use this to confirm the signal being transmitted to the PC/RGB terminal.

It is set to RGB and can not be adjusted.

SET UP	
LANGUAGE	: ENGLISH
DVD/HD1 INPUT	: COMPONENT
→ D-SUB INPUT	: RGB
HD SELECT	: 1080I
RGB SELECT	: AUTO
HDMI SET UP	: HIGH
COLOR SYSTEM	: AUTO
BACK GROUND	: GRAY
GRAY LEVEL	: 3
S1/S2	: OFF
DISPLAY OSM	: ON
OSM ADJ.	: TOP LEFT
REMOTE ID	: ALL
ALL RESET	: OFF
CAN NOT ADJUST	

### Setting high definition images to the suitable screen size

Use this procedure to set whether the number of vertical lines of the input high definition image is 1080I or 1035I or 540P.

Example: Setting the "HD SELECT" mode to "1035I"

Set "ADVANCED OSM" to "ON" in the FUNCTION menu.

On "HD SELECT" of "SET UP" menu, select "1035I".

SET UP	
LANGUAGE	: ENGLISH
DVD/HD1 INPUT	: COMPONENT
D-SUB INPUT	: RGB
→ HD SELECT	: <1035I>
RGB SELECT	: AUTO
HDMI SET UP	: HIGH
COLOR SYSTEM	: AUTO
BACK GROUND	: GRAY
GRAY LEVEL	: 3
S1/S2	: OFF
DISPLAY OSM	: ON
OSM ADJ.	: TOP LEFT
REMOTE ID	: ALL
ALL RESET	: OFF
◀ SEL.	▶ ADJ. [EXIT] RETURN

#### Information

##### ■ HD SELECT modes

These 3 modes are not displayed in correct image automatically.

1080I: Standard digital broadcasts

1035I: Japanese "High Vision" signal format

540P: Special Digital broadcasts (for example : DTC100)

### Setting a computer image to the correct RGB select screen

With the computer image, select the RGB Select mode for a moving image such as (video) mode, wide mode or digital broadcast.

Example: Setting the "RGB SELECT" mode to "852 × 480"

Set "ADVANCED OSM" to "ON" in the FUNCTION menu.

On "RGB SELECT" of "SET UP" menu, select "852 × 480".

SET UP	
LANGUAGE	: ENGLISH
DVD/HD1 INPUT	: COMPONENT
D-SUB INPUT	: RGB
HD SELECT	: 1080I
→ RGB SELECT	: <852 × 480>
HDMI SET UP	: HIGH
COLOR SYSTEM	: AUTO
BACK GROUND	: GRAY
GRAY LEVEL	: 3
S1/S2	: OFF
DISPLAY OSM	: ON
OSM ADJ.	: TOP LEFT
REMOTE ID	: ALL
ALL RESET	: OFF
◀ SEL.	▶ ADJ. [EXIT] RETURN

## Information

### ■ RGB SELECT modes

**AUTO:** Select the suitable mode for the specifications of input signals as listed in the table "Computer input signals supported by this system" on page 39, 42 and 45.

**The others:** The available resolutions are shown.

See page 39, 42 and 45 for the details of the above settings.

## Setting the black level for HDMI signal

Set the black level.

Example: Setting the "HDMI SET UP" mode to "LOW"

Set "ADVANCED OSM" to "ON" in the FUNCTION menu.

On "HDMI SET UP" of "SET UP" menu, select "LOW".

SET UP	
LANGUAGE	: ENGLISH
DVD/HD1 INPUT	: COMPONENT
D-SUB INPUT	: RGB
HD SELECT	: 1080I
RGB SELECT	: AUTO
→HDMI SET UP	: <LOW>
COLOR SYSTEM	: AUTO
BACK GROUND	: GRAY
GRAY LEVEL	: 3
S1/S2	: OFF
DISPLAY OSM	: ON
OSM ADJ.	: TOP LEFT
REMOTE ID	: ALL
ALL RESET	: OFF
◀SEL.	▶ADJ. [EXIT]RETURN

## Information

### ■ HDMI SET UP settings

**LOW:** When connected to the PC signal.

**HIGH:** When connected to the SET TOP BOX, DVD etc. Change "HIGH" into "LOW" if the black level appears gray.

## Setting the video signal format

Use these operations to set the color systems of composite video signals or Y/C input signals.

Example: Setting the color system to "3.58 NTSC"

Set "ADVANCED OSM" to "ON" in the FUNCTION menu.

On "COLOR SYSTEM" of "SET UP" menu, select "3.58NTSC".

SET UP	
LANGUAGE	: ENGLISH
DVD/HD1 INPUT	: COMPONENT
D-SUB INPUT	: RGB
HD SELECT	: 1080I
RGB SELECT	: AUTO
HDMI SET UP	: HIGH
→COLOR SYSTEM	: <3.58NTSC>
BACK GROUND	: GRAY
GRAY LEVEL	: 3
S1/S2	: OFF
DISPLAY OSM	: ON
OSM ADJ.	: TOP LEFT
REMOTE ID	: ALL
ALL RESET	: OFF
◀SEL.	▶ADJ. [EXIT]RETURN

## Information

### ■ Video signal formats

Different countries use different formats for video signals. Set to the color system used in your current country.

**AUTO:** The color systems are automatically identified and the format is set accordingly.

**PAL:** This is the standard format used mainly in the United Kingdom and Germany.

**SECAM:** This is the standard format used mainly in France and Russia.

**4.43 NTSC, PAL60:** This format is used for videos in countries using PAL and SECAM video signals.

**3.58 NTSC:** This is the standard format used mainly in the United States and Japan.

**PAL-M:** This is the standard format used mainly in Brazil.

**PAL-N:** This is the standard format used mainly in Argentina.

## Setting the background color when no signal is being input

The color displayed on the background when there is no signal can be set to gray.

Example: Setting "BACK GROUND" to "BLACK"

Set "ADVANCED OSM" to "ON" in the FUNCTION menu.

On "BACK GROUND" of "SET UP" menu, select "BLACK".

SET UP	
LANGUAGE	: ENGLISH
DVD/HD1 INPUT	: COMPONENT
D-SUB INPUT	: RGB
HD SELECT	: 1080I
RGB SELECT	: AUTO
HDMI SET UP	: HIGH
COLOR SYSTEM	: AUTO
→BACK GROUND	: <BLACK>
GRAY LEVEL	: 3
S1/S2	: OFF
DISPLAY OSM	: ON
OSM ADJ.	: TOP LEFT
REMOTE ID	: ALL
ALL RESET	: OFF
◀SEL.	▶ADJ. [EXIT]RETURN

## Information

### ■ BACK GROUND Settings

**BLACK:** Sets the background color to black.

**GRAY:** Sets the background color to gray.

Setting this makes it easier to see that there is no signal.

## Setting the gray level for the sides of the screen

Use this procedure to set the gray level for the parts on the screen on which nothing is displayed when the screen is set to the 4:3 size.

Example: Setting "GRAY LEVEL" to "5"

Set "ADVANCED OSM" to "ON" in the FUNCTION menu.

On "GRAY LEVEL" of "SET UP" menu, select "5".

SET UP		
LANGUAGE	: ENGLISH	
DVD/HD1 INPUT	: COMPONENT	
D-SUB INPUT	: RGB	
HD SELECT	: 1080I	
RGB SELECT	: AUTO	
HDMI SET UP	: HIGH	
COLOR SYSTEM	: AUTO	
BACK GROUND	: GRAY	
→ GRAY LEVEL	: <5>	
S1/S2	: OFF	
DISPLAY OSM	: ON	
OSM ADJ.	: TOP LEFT	
REMOTE ID	: ALL	
ALL RESET	: OFF	
↵ SEL.	↔ ADJ.	EXIT/RETURN

### Information

#### ■ GRAY LEVEL settings

This adjusts the brightness of the black (the gray level) for the sides of the screen.

The standard is 0 (black). The level can be adjusted from 0 to 15. The factory setting is 3 (dark gray).

## Setting the screen size for S1/S2 video input

If the S-video signal contains screen size information, the image will be automatically adjusted to fit the screen when S1/S2 is set to AUTO.

This feature is available only when an S-video signal is input via the VIDEO2 terminal.

Example: Setting "S1/S2" to "AUTO"

Set "ADVANCED OSM" to "ON" in the FUNCTION menu.

On "S1/S2" of "SET UP" menu, select "AUTO".

SET UP		
LANGUAGE	: ENGLISH	
DVD/HD1 INPUT	: COMPONENT	
D-SUB INPUT	: RGB	
HD SELECT	: 1080I	
RGB SELECT	: AUTO	
HDMI SET UP	: HIGH	
COLOR SYSTEM	: AUTO	
BACK GROUND	: GRAY	
GRAY LEVEL	: 3	
S1/S2	: OFF	
→ DISPLAY OSM	: <OFF>	
OSM ADJ.	: TOP LEFT	
REMOTE ID	: ALL	
ALL RESET	: OFF	
↵ SEL.	↔ ADJ.	EXIT/RETURN

### Information

#### ■ DISPLAY OSM settings

ON: The informations on screen size, volume control, etc. will be shown.

OFF: The informations on screen size, volume control, etc. will not be shown.

The DISPLAY button on the remote control will not function either.

## Setting the position of the menu

Adjusts the position of the menu when it appears on the screen.

Example: Set the position to "TOP CENTER"

Set "ADVANCED OSM" to "ON" in the FUNCTION menu.

On "OSM ADJ." of "SET UP" menu, select "TOP CENTER".

SET UP		
LANGUAGE	: ENGLISH	
DVD/HD1 INPUT	: COMPONENT	
D-SUB INPUT	: RGB	
HD SELECT	: 1080I	
RGB SELECT	: AUTO	
HDMI SET UP	: HIGH	
COLOR SYSTEM	: AUTO	
BACK GROUND	: GRAY	
GRAY LEVEL	: 3	
S1/S2	: OFF	
DISPLAY OSM	: ON	
→ OSM ADJ.	: <TOP CENTER>	
REMOTE ID	: ALL	
ALL RESET	: OFF	
↵ SEL.	↔ ADJ.	EXIT/RETURN

### Information

#### ■ OSM ADJ. settings

TOP LEFT	TOP CENTER	TOP RIGHT
BTM LEFT	BTM CENTER	BTM RIGHT

### Information

#### ■ S1/S2 settings

AUTO: Adjusts the screen size automatically according to the S1/S2 video signal.

F

## Turning on/off the menu display

When this is set to OFF, the menu will not be displayed even if you press the MENU/ENTER button.

Example: Turning the DISPLAY OSM off

Set "ADVANCED OSM" to "ON" in the FUNCTION menu.

On "DISPLAY OSM" of "SET UP" menu, select "OFF".

## Remote ID

Set the remote code to adapt the plasma monitor to the remote control.

Example: Setting to "1"

Set "ADVANCED OSM" to "ON" in the FUNCTION menu.

On "REMOTE ID" of "SET UP" menu, select "1".

SET UP	
LANGUAGE	: ENGLISH
DVD/HD1 INPUT	: COMPONENT
D-SUB INPUT	: RGB
HD SELECT	: 1080I
RGB SELECT	: AUTO
HDMI SET UP	: HIGH
COLOR SYSTEM	: AUTO
BACK GROUND	: GRAY
GRAY LEVEL	: 3
S1/S2	: OFF
DISPLAY OSM	: ON
OSM ADJ.	: TOP LEFT
→ REMOTE ID	: <1>
ALL RESET	: OFF
◀ SEL.	▶ ADJ. [EXIT] RETURN

- Press and hold the POWER ON button, and release the button when the indication saying that the code is set is displayed. Or, press and hold the POWER STANDBY button, and release the button when the power is turned off.

### Information

#### ■ REMOTE ID setting

ALL: The remote code is not set.

1 to 4: The specified remote code is applied.

## Resetting to the default values

Use these operations to restore all the settings (PICTURE, AUDIO, IMAGE ADJUST, SET UP, etc.) to the factory default values.

Refer to page 21 for items to be reset.

On "ALL RESET" of "SET UP" menu, select "ON", then press the MENU/ENTER button.

SET UP		ALL RESET	
LANGUAGE	: ENGLISH	SETTING NOW	
DVD/HD1 INPUT	: COMPONENT		
D-SUB INPUT	: RGB		
HD SELECT	: 1080I		
RGB SELECT	: AUTO		
HDMI SET UP	: HIGH		
COLOR SYSTEM	: AUTO		
BACK GROUND	: GRAY		
GRAY LEVEL	: 3		
S1/S2	: OFF		
DISPLAY OSM	: ON		
OSM ADJ.	: TOP LEFT		
REMOTE ID	: ALL		
→ ALL RESET	: <ON>		
◀ SEL.	▶ ADJ. [EXIT] RETURN		

When the "SETTING NOW" screen disappears, then all the settings are restored to the default values.

## Function Settings Menu

### Setting the menu mode

This allows you to access the complete menu.

Example: Setting "ON"

On "ADVANCED OSM" of "FUNCTION" menu, select "ON".

FUNCTION	
→ ADVANCED OSM	: <ON>
POWER MGT.	: OFF
INPUT SKIP	: OFF
SUB. PICTURE	
ZOOM NAV	: BTM LEFT
PICTURE FREEZE	: S BY S1
PDP SAVER	: MANUAL
CLOSED CAPTION	: OFF
CAPTION CONT	: LOW
PWR. ON MODE	
◀ SEL.	▶ ADJ. [EXIT] RETURN

### Information

#### ■ ADVANCED OSM settings

ON: All of the menu items are available for advanced users.

OFF: Some of the menu items are not available (e.g.FUNCTION).

## Setting the power management for computer images

This energy-saving (power management) function automatically reduces the monitor's power consumption if no operation is performed for a certain amount of time.

Example: Turning the power management function on

Set "ADVANCED OSM" to "ON" in the FUNCTION menu.

On "POWER MGT." of "FUNCTION" menu, select "ON".

FUNCTION	
ADVANCED OSM	: OFF
→ POWER MGT.	: <ON>
INPUT SKIP	: OFF
SUB. PICTURE	
ZOOM NAV	: BTM LEFT
PICTURE FREEZE	: S BY S1
PDP SAVER	: MANUAL
CLOSED CAPTION	: OFF
CAPTION CONT	: LOW
PWR. ON MODE	
◀ SEL.	▶ ADJ. [EXIT] RETURN

### Information

#### ■ Power management function

\* The power management function automatically reduces the monitor's power consumption if the computer's keyboard or mouse is not operated for a certain amount of time. This function can be used when using the monitor with a computer.

\* If the computer's power is not turned on or if the computer and selector tuner are not properly connected, the system is set to the off state.

\* For instructions on using the computer's power management function, refer to the computer's operating instructions.

#### ■ Power management settings

ON: In this mode the power management function is turned on.

OFF: In this mode the power management function is turned off.

#### ■ Power management function and ON/STANDBY indicator

The ON/STANDBY indicator indicates the status of the power management function. See page 31 for indicator status and description.



## ON/STANDBY indicator

Power management mode	ON/STANDBY indicator	Power management operating status	Description	Turning the picture back on
On	Green	Not activated.	Horizontal and vertical synchronizing signals are present from the computer.	Picture already on.
Off	Red	Activated.	Horizontal and/or vertical synchronizing signals are not sent from the computer.	Operate the keyboard or mouse. The picture reappears.

### Setting the Input Skip

When this is ON, signals which are not present will be skipped over and only pictures whose signals are being transmitted will be displayed.

This setting is valid only for the INPUT/EXIT button on the unit.

Example: Set to "ON"

Set "ADVANCED OSM" to "ON" in the FUNCTION menu.

On "INPUT SKIP" of "FUNCTION" menu, select "ON".

FUNCTION	
ADVANCED OSM	: OFF
POWER MGT.	: OFF
→ INPUT SKIP	: <ON>
SUB. PICTURE	
ZOOM NAV	: BTM LEFT
PICTURE FREEZE	: S BY S1
PDP SAVER	: MANUAL
CLOSED CAPTION	: OFF
CAPTION CONT	: LOW
PWR. ON MODE	
← SEL.	↔ ADJ. EXIT/RETURN

### Information

#### ■ INPUT SKIP settings

OFF: Regardless of the presence of the signal, scan and display all signals.

ON: If no input signal is present, skip that signal.

\* "SETTING NOW" will appear during the input search.

### Removing the sub screen area when there is no input signal detected for the sub screen

This function automatically removes the black frame of the sub screen when there is no sub screen input signal. This feature is available only when the picture-in-picture mode is selected.

Example: Setting "DISPLAY" to "FADE"

Set "ADVANCED OSM" to "ON" in the FUNCTION menu.

On "SUB. PICTURE" of "FUNCTION" menu, press the MENU/ENTER button.

The "SUB. PICTURE" screen appears.

Adjust the items.

SUB. PICTURE	
SUB. P DETECT	: AUTO
→ DISPLAY	: <FADE>
SUB. P RATE	: 100%
← SEL.	↔ ADJ. EXIT/RETURN

### Information

#### ■ SUB. PICTURE Function

\* Loss of the input signal means a condition in which the video signal and the sync signal are not present.

\* Under conditions in which the sub screen has disappeared, the ZOOM NAV and PICTURE FREEZE functions will not work. The WIDE button will not function either.

#### ■ SUB. P DETECT setting

AUTO: The black frame disappears 3 seconds after the input signal is lost.

OFF: Turns off the SUB. PICTURE function.

#### ■ DISPLAY setting

NORMAL: The sub screen is displayed consistently.

FADE: The sub screen fades in.

#### ■ SUB. P RATE setting

Set the transparency of the sub screen.

### Displaying the entire image during DIGITAL ZOOM operations

Use this function to display the entire image within the sub screen together with an enlarged image on the main screen.

Example: Setting "ZOOM NAV" to "S BY S"

Set "ADVANCED OSM" to "ON" in the FUNCTION menu.

On "ZOOM NAV" of "FUNCTION" menu, select "S BY S".

FUNCTION	
ADVANCED OSM	: OFF
POWER MGT.	: OFF
INPUT SKIP	: OFF
SUB. PICTURE	
→ ZOOM NAV	: <S BY S>
PICTURE FREEZE	: S BY S1
PDP SAVER	: MANUAL
CLOSED CAPTION	: OFF
CAPTION CONT	: LOW
PWR. ON MODE	
← SEL.	↔ ADJ. EXIT/RETURN

### Information

#### ■ ZOOM NAV Function

\* This feature does not function during multi screen mode.

\* This feature does not function while PICTURE FREEZE is operating.

\* Providing a 2-screen display will cancel this function.

#### ■ ZOOM NAV settings

OFF: Will not show the entire image on the sub screen.

S BY S: Will show the entire image on the sub screen of side-by-side mode.

BTM LEFT~TOP LEFT: Will show the entire image on the sub screen of picture-in-picture mode.

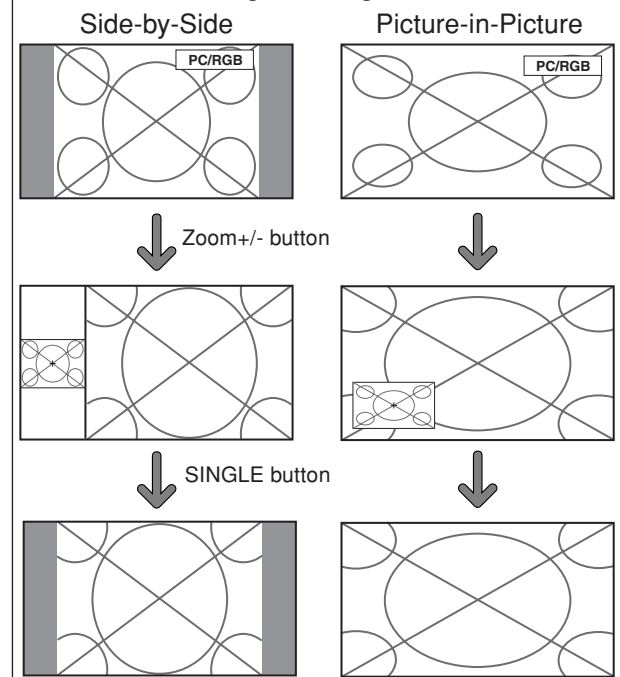

### Displaying still images in the sub screen

This feature enables display in the sub screen of still images captured by pressing the ACTIVE SELECT button.

Example: Setting "PICTURE FREEZE" to "BTM LEFT"

Set "ADVANCED OSM" to "ON" in the FUNCTION menu.  
 On "PICTURE FREEZE" of "FUNCTION" menu, select "BTM LEFT".

FUNCTION	
ADVANCED OSM	: OFF
POWER MGT.	: OFF
INPUT SKIP	: OFF
SUB. PICTURE	
ZOOM NAV	: BTM LEFT
→ PICTURE FREEZE	: ◀BTM LEFT▶
PDP SAVER	: MANUAL
CLOSED CAPTION	: OFF
CAPTION CONT	: LOW
PWR. ON MODE	
◀SEL.	▶ADJ. EXIT/RETURN

**Information**

■ PICTURE FREEZE Function

- \* This feature does not function during multi screen mode.
- \* Digital zoom is not available while this function is operating.
- \* A further press of the ACTIVE SELECT button while this function is operating will cancel this function.
- \* Providing a 2-screen display will cancel this function.

■ PICTURE FREEZE settings

OFF: Will not show the still image.  
 S BY S1, 2: The still images captured by pressing the ACTIVE SELECT button will be shown on the sub screen of side-by-side mode.  
 BTM LEFT~TOP LEFT: The still images captured by pressing the ACTIVE SELECT button will be shown on the sub screen of picture-in-picture mode.

Side-by-Side

Picture-in-Picture

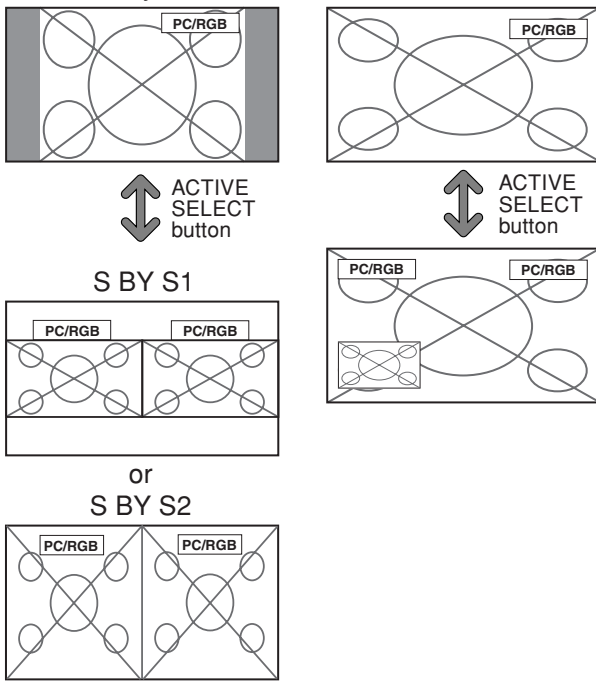

**Reducing image retention**

The brightness of the screen, the position of the picture, positive/negative mode and screen wiper are adjusted to reduce image retention.

Set "ADVANCED OSM" to "ON" in the FUNCTION menu.  
 On "PDP SAVER" of "FUNCTION" menu, select "MANUAL", then press the MENU/ENTER button.  
 The "PDP SAVER" screen appears.

PDP SAVER	
→ PEAK BRIGHT	: ◀100▶
ORBITER	: AUTO1
INVERSE/WHITE	: OFF
SCREEN WIPER	: OFF
SOFT FOCUS	: OFF
OSM ORBITER	: ON
OSM CONTRAST	: LOW
◀SEL.	▶ADJ. EXIT/RETURN

**Information**

■ When set to AUTO

Set automatically, as described below.  
 PEAK BRIGHT: 100%  
 ORBITER: AUTO1 or AUTO2  
 INVERSE/WHITE: OFF  
 SCREEN WIPER: OFF  
 SOFT FOCUS: OFF  
 OSM ORBITER: ON  
 OSM CONTRAST: LOW

**PEAK BRIGHT**

Use this to activate the brightness limiter.  
 Example: Setting "PEAK BRIGHT" to "75%"  
 On "PEAK BRIGHT" of "PDP SAVER" menu, select "75%".

PDP SAVER	
→ PEAK BRIGHT	: ◀75▶
ORBITER	: AUTO1
INVERSE/WHITE	: OFF
SCREEN WIPER	: OFF
SOFT FOCUS	: OFF
OSM ORBITER	: ON
OSM CONTRAST	: LOW
◀SEL.	▶ADJ. EXIT/RETURN

**Information**

■ PEAK BRIGHT settings

100%: The brightness of the screen is adjusted automatically to suit the picture quality.  
 75%, 50%, 25%: Sets maximum brightness. The brightness level decreases in the order of 75%, 50%, 25%. 25% provides minimum brightness.  
 \* These values are approximate.

**ORBITER**

Use this to set the picture shift.  
 Example: Setting "ORBITER" to "AUTO2"  
 On "ORBITER" of "PDP SAVER" menu, select "AUTO2".

PDP SAVER	
PEAK BRIGHT	: 100%
→ ORBITER	: ◀AUTO2▶
INVERSE/WHITE	: OFF
SCREEN WIPER	: OFF
SOFT FOCUS	: OFF
OSM ORBITER	: ON
OSM CONTRAST	: LOW
◀SEL.	▶ADJ. EXIT/RETURN

**Information**

■ ORBITER settings

OFF: Orbiter mode does not function. This is the default setting when PC/RGB is input.  
 AUTO1: The picture moves around the screen intermittently, making the picture smaller. This is the default setting when a Video or a DVD/HD signal is input. Set to "OFF" when these signals are not used.  
 AUTO2: The picture moves around the screen

intermittently, making the picture bigger.

\* When a Video or a DVD/HD signal is input, the AUTO1 and 2 functions will affect only the moving picture and will not make the screen smaller or bigger.

## INVERSE/WHITE

Use this to set the inverse mode or to display a white screen.

Example: Setting "INVERSE/WHITE" to "WHITE"

On "INVERSE/WHITE" of "PDP SAVER" menu, select "WHITE".

PDP SAVER	
PEAK BRIGHT	: 100%
ORBITER	: AUTO1
→ INVERSE/WHITE	: <WHITE >
SCREEN WIPER	: OFF
SOFT FOCUS	: OFF
OSM ORBITER	: ON
OSM CONTRAST	: LOW
← SEL.	↔ ADJ. [EXIT] RETURN

### Information

#### ■ INVERSE/WHITE Settings

OFF: Inverse/white mode does not function.

INVERSE: The picture is displayed alternately between positive image and negative image.

WHITE: The entire screen turns white.

## SCREEN WIPER

When this is set to ON, a white vertical bar moves repeatedly from the left and of the screen to the right end at a constant speed.

Example: Setting "SCREEN WIPER" to "ON"

On "SCREEN WIPER" of "PDP SAVER" menu, select "ON".

PDP SAVER	
PEAK BRIGHT	: 100%
ORBITER	: AUTO1
INVERSE/WHITE	: OFF
→ SCREEN WIPER	: <ON >
SOFT FOCUS	: OFF
OSM ORBITER	: ON
OSM CONTRAST	: LOW
← SEL.	↔ ADJ. [EXIT] RETURN

### Information

#### ■ SCREEN WIPER

ON: The white vertical bar appears.

OFF: Screen wiper mode does not function.

## SOFT FOCUS

Reduces edges and softens the image.

Example: Setting "SOFT FOCUS" to "LEVEL2"

On "SOFT FOCUS" of "PDP SAVER" menu, select "LEVEL2".

PDP SAVER	
PEAK BRIGHT	: 100%
ORBITER	: AUTO1
INVERSE/WHITE	: OFF
SCREEN WIPER	: OFF
→ SOFT FOCUS	: <LEVEL2 >
OSM ORBITER	: ON
OSM CONTRAST	: LOW
← SEL.	↔ ADJ. [EXIT] RETURN

### Information

#### ■ SOFT FOCUS settings

OFF: Turns the SOFT FOCUS function off.

LEVEL1, 2, 3, 4: Activates the SOFT FOCUS setting.

The higher numbers create a softer image.

"SHARPNESS" can not be adjusted on the "PICTURE" menu.

## OSM ORBITER

Use this to set OSM menu shift.

Example: Setting "OSM ORBITER" to "OFF"

On "OSM ORBITER" of "PDP SAVER" menu, select "OFF".

PDP SAVER	
PEAK BRIGHT	: 100%
ORBITER	: AUTO1
INVERSE/WHITE	: OFF
SCREEN WIPER	: OFF
SOFT FOCUS	: OFF
→ OSM ORBITER	: <OFF >
OSM CONTRAST	: LOW
← SEL.	↔ ADJ. [EXIT] RETURN

### Information

#### ■ OSM ORBITER settings

ON: The position of the menu will be shifted by eight dots each time OSM is displayed.

OFF: OSM will be displayed at the same position.

## OSM CONTRAST

Use this to reduce the brightness of OSM menu.

Example: Setting "OSM CONTRAST" to "NORMAL"

On "OSM CONTRAST" of "PDP SAVER" menu, select "NORMAL".

PDP SAVER	
PEAK BRIGHT	: 100%
ORBITER	: AUTO1
INVERSE/WHITE	: OFF
SCREEN WIPER	: OFF
SOFT FOCUS	: OFF
OSM ORBITER	: ON
→ OSM CONTRAST	: <NORMAL >
← SEL.	↔ ADJ. [EXIT] RETURN

### Information

#### ■ OSM CONTRAST settings

NORMAL: OSM brightness is set to normal.

LOW: OSM brightness is set to lower.

## Setting Closed Caption

This function sets several closed caption modes that allows text to be superimposed in the active video.

Example: Setting "CAPTION2"

Set "ADVANCED OSM" to "ON" in the FUNCTION menu.

On "CLOSED CAPTION" of "FUNCTION" menu, select "CAPTION2".

FUNCTION	
ADVANCED OSM	: OFF
POWER MGT.	: OFF
INPUT SKIP	: OFF
SUB. PICTURE	
ZOOM NAV	: BTM LEFT
PICTURE FREEZE	: S BY S1
PDP SAVER	: MANUAL
→ CLOSED CAPTION	: <CAPTION2 >
CAPTION CONT	: LOW
PWR. ON MODE	
← SEL.	↔ ADJ. [EXIT] RETURN

**Information**

**■ CLOSED CAPTION settings**

OFF: This exits the closed caption mode.  
 CAPTION1~4: Text is superimposed.  
 TEXT1~4: Text is displayed in full screen.  
 A closed caption signal may not be decoded in the following signature;  
 1. when a video tape has been dubbed.  
 2. when the signal reception is weak.  
 3. when the signal reception is nonstandard.  
 When using closed captioned channel or the text mode, the text screen always appears.  
 When there is no signal, however, the text screen will not display text characters.

**Reducing the brightness of Closed Caption**

Use this to reduce the brightness of Closed Caption.  
 Example: Setting "NORMAL"  
 Set "ADVANCED OSM" to "ON" in the FUNCTION menu.  
 On "CAPTION CONT" of "FUNCTION" menu, select "NORMAL".

FUNCTION	
ADVANCED OSM	: OFF
POWER MGT.	: OFF
INPUT SKIP	: OFF
SUB. PICTURE	
ZOOM NAV	: BTM LEFT
PICTURE FREEZE	: S BY S1
PDP SAVER	: MANUAL
CLOSED CAPTION	: OFF
→ CAPTION CONT	: <NORMAL>
PWR. ON MODE	
↔ SEL.	↔ ADJ. [EXIT] RETURN

**Information**

**■ CAPTION CONT settings**

NORMAL: Closed Caption brightness is set to normal.  
 LOW: Closed Caption brightness is set to lower.

**Setting the power on mode**

This function sets the input mode and the sound volume at the time the power is switched on.  
 Example: Setting the input mode to "VIDEO2"  
 Set "ADVANCED OSM" to "ON" in the FUNCTION menu.  
 On "FUNCTION" menu, select "PWR.ON MODE", then press the MENU/ENTER button.  
 The "PWR.ON MODE" screen appears.  
 On "INPUT" of "PWR.ON MODE" menu, select "VIDEO2".  
 The available inputs depend on the setting of input.

PWR. ON MODE	
→ INPUT	: <VIDEO2>
VOLUME	: 22
↔ SEL.	↔ ADJ. [EXIT] RETURN

**Information**

**■ INPUT settings**

LAST: Last mode (the input that was last selected at the time the power was switched off).  
 VIDEO1, 2: VIDEO input mode.  
 DVD/HD1~4: DVD/HD input mode.  
 PC/RGB: PC/RGB input mode.  
 MULTI: Multi screen mode.

**■ To set MULTI INPUT**

- Set the INPUT button to "MULTI", then press the MENU/ENTER button.

The "MULTI SCREEN SETTING" will appear on the screen.

- Use the ▲ and ▼ buttons to select "MULTI MODE", then use the ◀ and ▶ buttons to choose from "SIDE BY SIDE1~3" and "PICTURE IN PICTURE (BOTTOM LEFT~TOP LEFT)".
- Use the ▲ and ▼ buttons to select "MAIN"/"SUB" and "LEFT"/"RIGHT", then use the ◀ and ▶ buttons to choose from "VIDEO1~2", "DVD/HD1~4" and "PC/RGB".

**PICTURE IN PICTURE**

PWR. ON MODE MULTI SCREEN SETTING	
→ MULTI MODE	: <BOTTOM RIGHT>
INPUT MODE	
MAIN	: VIDEO1
SUB	: DVD/HD1
↔ SEL.	↔ ADJ. [EXIT] RETURN

**SIDE BY SIDE**

PWR. ON MODE MULTI SCREEN SETTING	
→ MULTI MODE	: <SIDE BY SIDE1>
INPUT MODE	
LEFT	: VIDEO1
RIGHT	: DVD/HD1
↔ SEL.	↔ ADJ. [EXIT] RETURN

**■ VOLUME settings**

LAST: Last mode (the volume that was last selected at the time the power was switched off).  
 0 to 42: The level of sound volume.

**Signal Information Menu**

**Checking the frequencies, polarities of input signals, and resolution**

Use this function to check the frequencies and polarities of the signals currently being input from a computer, etc.  
 On "MAIN MENU", select "SIGNAL INFO.", then press the MENU/ENTER button.  
 The "SIGNAL INFORMATION" is displayed.

SIGNAL INFORMATION	
H. FREQUENCY	: 48.4KHz
V. FREQUENCY	: 60.0Hz
H. POLARITY	: NEGATIVE
V. POLARITY	: NEGATIVE
MEMORY	: 24
RESOLUTION	: 1024 x 768
[EXIT] RETURN	

PC: MEMORY will be displayed.  
 Others: MODE will be displayed.

# External Control

# Pin Assignments

## Application

These specifications cover the communications control of the plasma monitor by external equipment.

## Connections

Connections are made as described below.

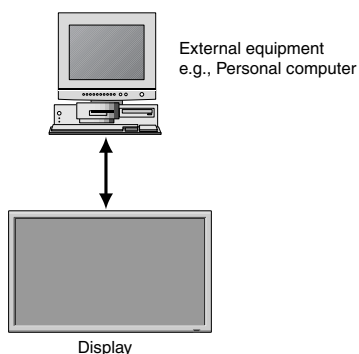

Connector on the plasma monitor side: EXTERNAL CONTROL connector.

Use a crossed (reverse) cable.

Type of connector: D-Sub 9-pin male

Pin No.	Pin Name	Pin No.	Pin Name
1	No Connection	6	DSR (DCE side ready)
2	RXD (Receive data)	7	RTS (Ready to send)
3	TXD (Transmit data)	8	CTS (Clear to send)
4	DTR (DTE side ready)	9	No connection
5	GND		

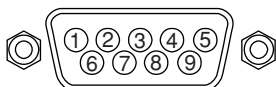

## Communication Parameters

- |                          |              |
|--------------------------|--------------|
| (1) Communication system | Asynchronous |
| (2) Interface            | RS-232C      |
| (3) Baud rate            | 9600 bps     |
| (4) Data length          | 8 bits       |
| (5) Parity               | Odd          |
| (6) Stop bit             | 1 bit        |
| (7) Communication code   | Hex          |

## External Control Codes (Reference)

FUNCTION		CODE DATA								
Power ON		9FH	80H	60H	4EH	00H	CDH			
OFF		9FH	80H	60H	4FH	00H	CEH			
Input Switch	Video1 (RCA)	DFH	80H	60H	47H	01H	08H			
	Video2 (S-Video)	DFH	80H	60H	47H	01H	02H	09H		
	DVD/HD1 (RCA)	DFH	80H	60H	47H	01H	05H	0CH		
	DVD/HD2 (RCA)	DFH	80H	60H	47H	01H	06H	0DH		
	DVD/HD3 (HDMI)	DFH	80H	60H	47H	01H	0EH	15H		
	PC/RGB (mini D-sub 15-pin)	DFH	80H	60H	47H	01H	07H	0EH		
	DVD/HD4 (HDMI)	DFH	80H	60H	47H	01H	1AH	21H		
Audio Mute	ON	9FH	80H	60H	3EH	00H	BDH			
	OFF	9FH	80H	60H	3FH	00H	BEH			
Picture Mode	NORMAL	DFH	80H	60H	0AH	01H	01H	CBH		
	THEATER 1	DFH	80H	60H	0AH	01H	02H	CCH		
	THEATER 2	DFH	80H	60H	0AH	01H	03H	CDH		
	DEFAULT	DFH	80H	60H	0AH	01H	04H	CEH		
	BRIGHT	DFH	80H	60H	0AH	01H	05H	CFH		
Screen Mode	STADIUM	DFH	80H	60H	51H	01H	02H	13H		
	ZOOM	DFH	80H	60H	51H	01H	03H	14H		
	NORMAL	DFH	80H	60H	51H	01H	04H	15H		
	ANAMORPHIC	DFH	80H	60H	51H	01H	05H	16H		
	UNDERSCAN	DFH	80H	60H	51H	01H	08H	19H		
	14 : 9	DFH	80H	60H	51H	01H	09H	1AH		
	2.35 : 1	DFH	80H	60H	51H	01H	0AH	1BH		
Auto Picture	ON	DFH	80H	60H	7FH	03H	03H	09H	00H	4DH
	OFF	DFH	80H	60H	7FH	03H	03H	09H	01H	4EH
Cinema Mode	ON	DFH	80H	60H	C1H	01H	01H	82H		
	OFF	DFH	80H	60H	C1H	01H	02H	83H		

**Note:** Contact your local dealer for a full list of the External Control Codes if needed.

## mini D-Sub 15-pin connector (Analog)

PC/RGB

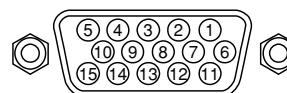

Pin No.	Signal (Analog)
1	Red
2	Green or sync-on-green
3	Blue
4	No connection
5	Ground
6	Red ground
7	Green ground
8	Blue ground
9	No connection
10	Sync signal ground
11	No connection
12	Bi-directional DATA (SDA)
13	Horizontal sync or Composite sync
14	Vertical sync
15	Data clock

## 1/8 Stereo Mini Jack (not supplied) for REMOTE IN/OUT

Plasma monitor REMOTE IN

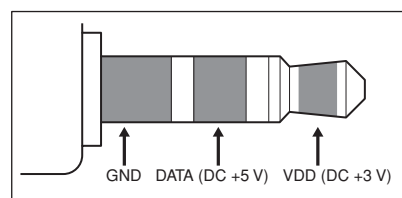

Plasma monitor REMOTE OUT

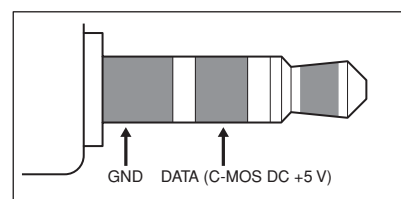

# Connection with STB

---

Following is the connection example of STB (Set-top Box) using the REMOTE IN/OUT connectors of the plasma monitor. Consult your dealer about the actual connection and operation.

## \* Connection Example

- STB has the REMOTE IN connector.
- The pin assignment of the REMOTE IN connector of STB is same as that of 1/8 stereo mini cable connected to the REMOTE OUT connector (Page 35).
- The transmit frequency of the remote control of STB is 37.9 kHz (Typical).

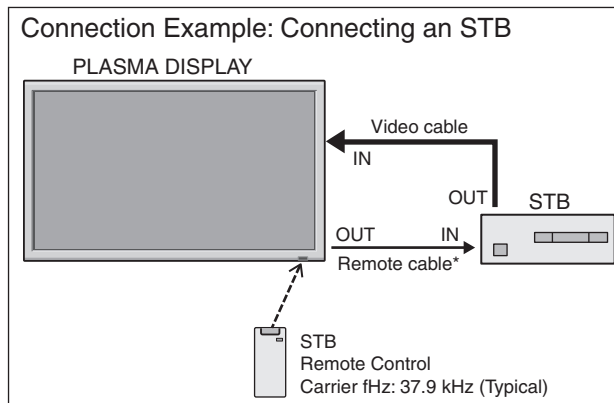

\* The 1/8 Stereo Mini cable must be purchased separately.



# Troubleshooting

If the picture quality is poor or there is some other problem, check the adjustments, operations, etc., before requesting service.

Symptom	Checks	Remedy
The unit emits a crackling sound.	<ul style="list-style-type: none"> <li>• Are the image and sound normal?</li> </ul>	<ul style="list-style-type: none"> <li>• If there are no abnormalities in the image and sound, the noise is caused by the cabinet reacting to changes in temperature. This will not affect performance.</li> </ul>
Picture is disturbed. Sound is noisy. Remote control operates erroneously.	<ul style="list-style-type: none"> <li>• Is a connected component set directly in front or at the side of the display?</li> </ul>	<ul style="list-style-type: none"> <li>• Leave some space between the display and the connected components.</li> </ul>
The remote control does not work.	<ul style="list-style-type: none"> <li>• Are the remote control's batteries worn out?</li> </ul>	<ul style="list-style-type: none"> <li>• Replace both batteries with new ones.</li> </ul>
Monitor's power does not turn on when the remote control's power button is pressed.	<ul style="list-style-type: none"> <li>• Is the monitor's power cord plugged into a power outlet?</li> </ul>	<ul style="list-style-type: none"> <li>• Plug the monitor's power cord into a power outlet.</li> </ul>
	<ul style="list-style-type: none"> <li>• Are all the monitor's indicators off?</li> </ul>	<ul style="list-style-type: none"> <li>• Press the power button on the monitor to turn on the power.</li> </ul>
	<ul style="list-style-type: none"> <li>• Are the remote control's batteries worn out?</li> </ul>	<ul style="list-style-type: none"> <li>• Replace both batteries with new ones.</li> </ul>
Monitor does not operate when the remote control's buttons are pressed.	<ul style="list-style-type: none"> <li>• Is the remote control pointed at the monitor, or is there an obstacle between the remote control and the monitor?</li> </ul>	<ul style="list-style-type: none"> <li>• Point the remote control at the monitor's remote control sensor when pressing buttons, or remove the obstacle.</li> </ul>
	<ul style="list-style-type: none"> <li>• Is direct sunlight or strong artificial light shining on the monitor's remote control sensor?</li> </ul>	<ul style="list-style-type: none"> <li>• Eliminate the light by closing curtains, pointing the light in a different direction, etc.</li> </ul>
	<ul style="list-style-type: none"> <li>• Are the remote control's batteries worn out?</li> </ul>	<ul style="list-style-type: none"> <li>• Replace both batteries with new ones.</li> </ul>
No sound or picture is produced.	<ul style="list-style-type: none"> <li>• Is the monitor's power cord plugged into a power outlet?</li> </ul>	<ul style="list-style-type: none"> <li>• Plug the monitor's power cord into a power outlet.</li> </ul>
Picture appears but no sound is produced.	<ul style="list-style-type: none"> <li>• Is the volume set at the minimum?</li> </ul>	<ul style="list-style-type: none"> <li>• Increase the volume.</li> </ul>
	<ul style="list-style-type: none"> <li>• Is the mute mode set?</li> </ul>	<ul style="list-style-type: none"> <li>• Press the remote control's MUTE button.</li> </ul>
	<ul style="list-style-type: none"> <li>• Are the speakers properly connected?</li> </ul>	<ul style="list-style-type: none"> <li>• Connect the speakers properly.</li> </ul>
	<ul style="list-style-type: none"> <li>• Is AUDIO INPUT set correctly?</li> </ul>	<ul style="list-style-type: none"> <li>• Set AUDIO INPUT on the AUDIO menu correctly.</li> </ul>
Poor picture with VIDEO signal input.	<ul style="list-style-type: none"> <li>• Improper control setting.</li> <li>• Local interference.</li> <li>• Cable interconnections.</li> <li>• Input impedance is not correct level.</li> </ul>	<ul style="list-style-type: none"> <li>• Adjust picture control as needed.</li> <li>• Try another location for the monitor.</li> <li>• Be sure all connections are secure.</li> </ul>
Poor picture with RGB signal input.	<ul style="list-style-type: none"> <li>• Improper control setting.</li> <li>• Incorrect 15 PIN connector pin connections.</li> </ul>	<ul style="list-style-type: none"> <li>• Adjust picture controls as needed.</li> <li>• Check pin assignments and connections.</li> </ul>
Tint is poor or colors are weak.	<ul style="list-style-type: none"> <li>• Are the tint and colors properly adjusted?</li> </ul>	<ul style="list-style-type: none"> <li>• Adjust the tint and color (under PICTURE).</li> </ul>
Nothing appears on screen.	<ul style="list-style-type: none"> <li>• Is the computer's power turned on?</li> </ul>	<ul style="list-style-type: none"> <li>• Turn on the computer's power.</li> </ul>
	<ul style="list-style-type: none"> <li>• Is a source connected?</li> </ul>	<ul style="list-style-type: none"> <li>• Connect source to the monitor.</li> </ul>
	<ul style="list-style-type: none"> <li>• Is the power management function in the standby or off mode?</li> </ul>	<ul style="list-style-type: none"> <li>• Operate the computer (move the mouse, etc.).</li> </ul>
Part of picture is cut off or picture is not centered.	<ul style="list-style-type: none"> <li>• Is the position adjustment appropriate?</li> </ul>	<ul style="list-style-type: none"> <li>• Adjust the IMAGE ADJUST properly.</li> </ul>
Image is too large or too small.	<ul style="list-style-type: none"> <li>• Is the screen size adjustment appropriate?</li> </ul>	<ul style="list-style-type: none"> <li>• Press the WIDE button on the remote control and adjust properly.</li> </ul>
Picture is unstable.	<ul style="list-style-type: none"> <li>• Is the computer's resolution setting appropriate?</li> </ul>	<ul style="list-style-type: none"> <li>• Set to the proper resolution.</li> </ul>
ON/STANDBY indicator is lighted in red.	<ul style="list-style-type: none"> <li>• Horizontal and / or vertical sync signal is not present when the Intelligent Power Manager control is on.</li> </ul>	<ul style="list-style-type: none"> <li>• Check the input signal.</li> </ul>
ON/STANDBY indicator is blinking in red.	<ul style="list-style-type: none"> <li>• The temperature inside the main unit has become too high and has activated the protector.</li> </ul>	<ul style="list-style-type: none"> <li>• Promptly switch off the power of the main unit and wait until the internal temperature drops. See*1.</li> </ul>
ON/STANDBY indicator is blinking in green and red, or green.	<p style="text-align: center;">—————</p>	<ul style="list-style-type: none"> <li>• Promptly switch off the power of the main unit. See *2.</li> </ul>

**\*1 Overheat protector**

If the monitor becomes too hot, the overheat protector will be activated and the monitor will be turned off. If this happens, turn off the power to the monitor and unplug the power cord. If the room where the monitor is installed is particularly hot, move the monitor to a cooler location and wait for the monitor to cool for 60 minutes. If the problem persists, contact your dealer.

**\*2 In the following case, power off the monitor immediately and contact your dealer or authorized Service Center.**

The monitor turns off 5 seconds after powering on and then the ON/STANDBY indicator blinks. It indicates that the power supply circuit, plasma display panel, temperature sensor, or one or more fans have been damaged.

**NOTE: Pixel defect**

Plasma is one of the most advanced technologies for consumer products. The panel is made by high precision technology, however some pixel defects may be found on the Plasma display panel. We are trying our best to control the quality in order to reduce the number of defective pixels. It is almost impossible to have zero pixel defects, even using the most advanced technology. This is not a problem only for Marantz, but all Plasma manufacturers. Therefore we have to note that the warranty does not cover the Plasma display panel for pixel defects. We appreciate your understanding.

# Specifications: PD5001

<b>Screen Size</b>	43.5 inches(H) × 24.4 inches(V) 1104 mm(H) × 621 mm(V) diagonal 50 inches
<b>Aspect Ratio</b>	16 : 9
<b>Resolution</b>	1365 pixels(H) × 768 pixels(V)
<b>Pixel Pitch</b>	0.032 inches(H) × 0.032 inches(V) 0.81 mm(H) × 0.81 mm(V)
<b>Signals</b>	
Synchronization Range	Horizontal : 15.5 kHz to 110.0 kHz (automatic : step scan) Vertical : 50.0 Hz to 120.0 Hz (automatic : step scan)
Input Signals	RGB, NTSC (3.58/4.43), PAL (B,G,M,N), PAL60, SECAM, HD*1, DVD*1
<b>Input Terminals</b>	
<b>PC/RGB</b>	
Visual 1 (Analog)	mini D-sub 15-pin × 1
<b>Video</b>	
Visual 1	RCA × 1
Visual 2	S-Video: DIN 4-pin × 1
<b>DVD/HD</b>	
Visual 1	RCA-pin (Y, Cb/Pb, Cr/Pr) × 1*1
Visual 2	RCA-pin (Y, Cb/Pb, Cr/Pr) × 1*1
HDMI	HDMI connector × 2*2
<b>Audio</b>	Stereo RCA × 3 (Selectable)
<b>External Control</b>	D-sub 9-pin × 1 (RS-232C)
<b>Remote In</b>	Mini jack × 1
<b>Remote Out</b>	Mini jack × 1
<b>Sound output</b>	9 W+9 W at 6 ohm
<b>Power Supply</b>	AC100 V to 240 V 50 Hz/60 Hz
<b>Current Rating</b>	5.0 A (maximum)
<b>Power Consumption</b>	340 W (typical)
<b>Dimensions</b>	48.1 inches(W) × 29.0 inches(H) × 3.9 inches(D) 1222 mm(W) × 736 mm(H) × 99 mm(D)
<b>Weight</b>	78.3 lbs / 35.5 kg (without stand)
<b>Environmental Considerations</b>	
Operating Temperature	0 °C to 40 °C / 32 °F to 104 °F
Humidity	20 % to 80 % (no condensation)
Storage Temperature	-10 °C to 50 °C / 14 °F to 122 °F
Humidity	10 % to 90 % (no condensation)
<b>Other Features</b>	Motion compensated 3D Scan Converter (NTSC, PAL, 480I, 576I, 525I, 625I, 1035I, 1080I), 2-3 pull down Converter (NTSC, 480I, 525I, 1035I, 1080I (60 Hz)), 2-2 pull down Converter (PAL, 576I, 625I, NTSC, 480I, 525I), Digital Zooming (100 % to 900 % Selectable), Self Diagnosis via RS232C, PDP Saver (PEAK BRIGHT, ORBITER, INVERSE, WHITE, SCREEN WIPER, SOFT FOCUS, etc.), Color Temperature Select (high/middle/middle low/low, user has 4 memories), Auto Picture Adjust, Input Skip, Color Tune, Gamma Correction (4 modes), Plug and play (DDC1, DDC2b, HDMI: E-DDC), Enhanced Split Screen, etc.
<b>Accessories</b>	Power cord (× 1), Remote control (× 1), AAA batteries (× 2), Manuals (User guide), Ferrite cores for power cord (× 2), bands for power code (× 2), Cable clampers (× 3), beads bands (× 3), Ferrite core for remote cable (× 2), Warranty card
<b>Regulations</b>	UL 60065, CAN/CSA-C22.2 No.60065-03, FCC class B, ICES-003 class B

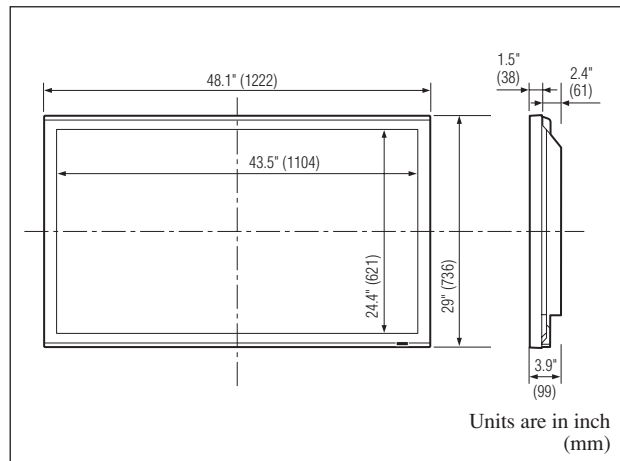

The features and specifications may be subject to change without notice.

**\*1 DVD/HD input signals supported on this system.**

480P (60 Hz)	480I (60 Hz)	525P (60 Hz)
525I (60 Hz)	576P (50 Hz)	576I (50 Hz)
625P (50 Hz)	625I (50 Hz)	720P (60 Hz)
720P (50 Hz)	1035I (60 Hz)	1080I (50 Hz)
1080I (60 Hz)	1080P (50 Hz)	1080P (60 Hz)

**\*2 HDMI input signals supported on this system.**

**Supported Signals**

- 640 × 480P @ 59.94/60 Hz
- 1280 × 720P @ 59.94/60 Hz
- 1920 × 1080I @ 59.94/60 Hz
- 720 × 480P @ 59.94/60 Hz
- 1440 (720) × 480I @ 59.94/60 Hz
- 1920 × 1080I @ 50 Hz
- 720 × 576P @ 50 Hz
- 1440 (720) × 576I @ 50 Hz
- 1280 × 720P @ 50 Hz

**Note:** In some cases a signal on the plasma monitor may not be displayed properly. The problem may be an inconsistency with standards from the source equipment (DVD, Set-top box, etc...). If you do experience such a problem please contact Marantz America, Inc. and also the manufacturer of the source equipment.

# Table of Signals Supported

## Supported resolution: PD5001

- When the screen mode is NORMAL, each signal is converted to a 1024 dots×768 lines signal. (Except for \*2,3)
- When the screen mode is ANAMORPHIC, each signal is converted to a 1365 dots×768 lines signal. (Except for \*2)

## Computer input signals supported by this system

Model Signal Type	Dots × lines	Vertical frequency (Hz)	Horizontal frequency (kHz)	Sync Polarity		Presence		Screen mode		RGB select*4	Memory
				Horizontal	Vertical	Horizontal	Vertical	NORMAL (4:3)	ANAMORPHIC (16:9)		
NEC PC-9800	640×400	70.1	31.5	NEG	NEG	YES	YES	--	YES	--	4
	720×400	70.1	31.5	NEG	NEG	YES	YES	--	YES	720×400	82
IBM PC/AT compatible computers	640×480	59.9	31.5	NEG	NEG	YES	YES	YES	YES	640×480	5
		72.8	37.9	NEG	NEG	YES	YES	YES	YES	--	7
		75.0	37.5	NEG	NEG	YES	YES	YES	YES	--	8
		85.0	43.3	NEG	NEG	YES	YES	YES	YES	--	9
		100.4	51.1	NEG	NEG	YES	YES	YES	YES	--	41
		120.4	61.3	NEG	NEG	YES	YES	YES	YES	--	42
	720×400	85.1	37.9	NEG	POS	YES	YES	--	YES	--	73
	848×480	60.0	31.0	POS	POS	YES	YES	--	YES	848×480	19
	852×480*1	60.0	31.7	NEG	NEG	YES	YES	--	YES	852×480	17
	800×600	56.3	35.2	POS	POS	YES	YES	YES	YES	800×600	11
		60.3	37.9	POS	POS	YES	YES	YES	YES	--	12
		72.2	48.1	POS	POS	YES	YES	YES	YES	--	13
		75.0	46.9	POS	POS	YES	YES	YES	YES	--	14
		85.1	53.7	POS	POS	YES	YES	YES	YES	--	15
		99.8	63.0	POS	POS	YES	YES	YES	YES	--	43
		120.0	75.7	POS	POS	YES	YES	YES	YES	--	44
	1024×768	60.0	48.4	NEG	NEG	YES	YES	YES*2	YES	1024×768	24
		70.1	56.5	NEG	NEG	YES	YES	YES*2	YES	1024×768	25
		75.0	60.0	POS	POS	YES	YES	YES*2	YES	1024×768	26
		85.0	68.7	POS	POS	YES	YES	YES*2	YES	--	27
		100.6	80.5	NEG	NEG	YES	YES	YES*2	YES	--	45
	1152×864	75.0	67.5	POS	POS	YES	YES	YES	YES	1152×864	51
		60.0	53.7	POS	NEG	YES	YES	YES	YES	1152×864	84
		72.0	64.9	POS	NEG	YES	YES	YES	YES	--	85
	1280×768	56.2	45.1	POS	POS	YES	YES	--	YES	1280×768	52
		59.8	48.0	POS	NEG	YES	YES	--	YES	1280×768	80
		69.8	56.0	NEG	POS	YES	YES	--	YES	1280×768	66
	1280×800*7	59.8	49.7	NEG	POS	YES	YES	--	YES	1280×800	21
	1280×854	60.0	53.1	NEG	NEG	YES	YES	--	YES	1280×854	37
		60.0	60.0	POS	POS	YES	YES	YES	YES	--	63
	1280×960	85.0	85.9	POS	POS	YES	YES	YES	YES	--	64
		60.0	47.7	POS	POS	YES	YES	--	YES*2	1360×765	22
	1360×768	60.0	47.7	POS	POS	YES	YES	--	YES*2	1360×768	22
	1376×768	59.9	48.3	NEG	POS	YES	YES	--	YES	1376×768	53
	1280×1024	60.0	64.0	POS	POS	YES	YES	YES*3	YES	1280×1024	29
		75.0	80.0	POS	POS	YES	YES	YES*3	YES	--	30
		85.0	91.1	POS	POS	YES	YES	YES*3	YES	--	40
		100.1	108.5	POS	POS	YES	YES	YES*3	YES	--	47
	1400×1050*7	60.0	65.3	NEG	POS	YES	YES	YES	YES	1400×1050	131
		74.9	82.3	NEG	POS	YES	YES	YES	YES	--	71
		85.0	93.9	NEG	POS	YES	YES	YES	YES	--	72
	1680×1050*7	60.0	65.3	NEG	POS	YES	YES	--	YES	1680×1050	38
	1600×1200	60.0	75.0	POS	POS	YES	YES	YES	YES	1600×1200	54
		65.0	81.3	POS	POS	YES	YES	YES	YES	--	55
		70.0	87.5	POS	POS	YES	YES	YES	YES	--	56
		75.0	93.8	POS	POS	YES	YES	YES	YES	--	57
		85.0	106.3	POS	POS	YES	YES	YES	YES	--	58
1920×1200*7	59.9	74.6	NEG	POS	YES	YES	--	YES	1920×1200	81	
1920×1200RB*7	60.0	74.0	NEG	POS	YES	YES	--	YES	1920×1200RB	88	
Apple Macintosh*5	640×480	66.7	35.0	Sync on G	Sync on G	--	--	YES	YES	--	6
	832×624	74.6	49.7	Sync on G	Sync on G	--	--	YES	YES	--	16
	1024×768	74.9	60.2	Sync on G	Sync on G	--	--	YES*2	YES	--	28
	1152×870	75.1	68.7	Sync on G	Sync on G	--	--	YES	YES	--	39
	1440×900*7	59.9	55.9	NEG	POS	YES	YES	--	YES	--	89

Model	Dots × lines	Vertical frequency (Hz)	Horizontal frequency (kHz)	Sync Polarity		Presence		Screen mode		RGB select*4	Memory
				Horizontal	Vertical	Horizontal	Vertical	NORMAL (4:3)	ANAMORPHIC (16:9)		
Work Station (EWS4800)	1280 × 1024	60.0	64.6	NEG	NEG	YES	YES	YES*3	YES	1280 × 1024	29
		71.2	75.1	NEG	NEG	YES	YES	YES*3	YES	--	48
Work Station (HP)	1280 × 1024	72.0	78.1	--	--	--	--	YES*3	YES	--	59
Work Station (SUN)	1152 × 900	66.0	61.8	C Sync	C Sync	--	--	YES	YES	--	60
		76.0	71.7	C Sync	C Sync	--	--	YES	YES	--	61
	1280 × 1024	76.1	81.1	C Sync	C Sync	--	--	YES*3	YES	--	30
Work Station (SGI)	1024 × 768	60.0	49.7	--	--	--	--	YES*2	YES	1024 × 768	62
	1280 × 1024	60.0	63.9	--	--	--	--	YES*3	YES	1280 × 1024	29
IDC-3000G											
PAL625P	768 × 576	50.0	31.4	NEG	NEG	YES	YES	YES*6	YES*6	--	31
NTSC525P	640 × 480	59.9	31.5	NEG	NEG	YES	YES	YES*6	YES*6	525P	32

\*1 Only when using a graphic accelerator board that is capable of displaying 852 × 480.

\*2 The picture is displayed in the original resolution.

\*3 The aspect ratio is 5:4. This signal is converted to a 960 dots × 768 lines signal.

\*4 Normally the RGB select mode suite for the input signals is set automatically. If the picture is not displayed properly, set the RGB mode prepared for the input signals listed in the table above.

\*5 To connect the monitor to Macintosh computer, use the monitor adapter (D-Sub 15-pin) to your computer's video port.

\*6 Other screen modes (ZOOM and STADIUM) are available as well.

\*7 CVT standard compliant.

**NOTE:**

- While the input signals comply with the resolution listed in the table above, you may have to adjust the position and size of the picture or the fine picture because of errors in synchronization of your computer.
- When a 1280 dots × 1024 lines signal or 1600 dots × 1200 lines signal is input to the monitor, the picture will be compressed.
- This monitor has a resolution of 1365 dots × 768 lines. It is recommended that the input signal should be XGA, wide XGA, or equivalent.
- With digital input some signals are not accepted.
- The sync may be disturbed when a nonstandard signal other than the aforementioned is input.
- If you are connecting a composite sync signal, use the HD terminal.

• “IBM PC/AT” and “XGA” are registered trademarks of International Business Machines, Inc. of the United States.

• “Apple Macintosh” is a registered trademark of Apple Computer, Inc. of the United States.

## DECLARATION OF CONFORMITY

This device complies with Part 15 of FCC Rules. Operation is subject to the following two conditions. (1) This device may not cause harmful interference, and (2) this device must accept any interference received, including interference that may cause undesired operation.

<b>U.S. Responsible Party:</b>	<b>Marantz America, Inc.</b>
<b>Address:</b>	<b>100 Corporate Drive, Mahwah, NJ, 07430, U.S.A.</b>
<b>Tel. No.:</b>	<b>630-741-0300</b>

Type of Product: Plasma Monitor

Equipment Classification: Class B Peripheral

Models: PD5001

*We hereby declare that the equipment specified above conforms to the technical standards as specified in the FCC Rules.*

**[www.marantz.com](http://www.marantz.com)**

You can find your nearest authorized distributor or dealer on our website.

**marantz**<sup>®</sup> is a registered trademark.