

Network Monitor

N1742L

N1742LP

N1942L

Make sure to read the **Important Precautions** before using the product.

Keep the User's Guide(CD) in an accessible place for future reference.

See the label attached on the product and give the information to your dealer when you ask for service.

With LG Network Monitor, some PC programs may not be compatible or need to be modified due to different kind of operation.

Please check the compatibility in advance, before purchasing or installing the software. LG do not have any kind of legal liability on this matter.

!!! Thank for selecting LGE products !!!

- Please make sure the following items are included with your monitor. If any items are missing, contact your dealer.



User's Guide/Cards

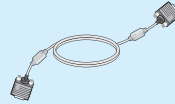

15-pin D-Sub Signal Cable

(To set it up, this signal cable may be attached to this product before shipping out.)



Power Cord

(Depending on the country)

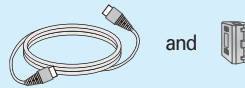

Lan cable and EMI Core

(These items are not included for all models.)

IMPORTANT

- This accessories may look different from those shown here.
- User must use shielded signal interface cables (D-sub 15 pin cable, LAN cable) with ferrite cores to maintain standard compliance for the product.

Important Precautions

This unit has been engineered and manufactured to ensure your personal safety, however improper use may result in potential electrical shock or fire hazards. In order to allow the proper operation of all safeguards incorporated in this display, observe the following basic rules for its installation, use, and servicing.

On Safety

Use only the power cord supplied with the unit. In case you use another power cord, make sure that it is certified by the applicable national standards if not being provided by the supplier. If the power cable is faulty in any way, please contact the manufacturer or the nearest authorized repair service provider for a replacement.

The power supply cord is used as the main disconnection device. Ensure that the socket-outlet is easily accessible after installation.

Operate the display only from a power source indicated in the specifications of this manual or listed on the display. If you are not sure what type of power supply you have in your home, consult with your dealer.

Overloaded AC outlets and extension cords are dangerous. So are frayed power cords and broken plugs. They may result in a shock or fire hazard. Call your service technician for replacement.

As long as this unit is connected to the AC wall outlet, it is not disconnected from the AC power source even if the unit is turned off.

Do not Open the Display:

- There are no user serviceable components inside.
- There are Dangerous High Voltages inside, even when the power is OFF.
- Contact your dealer if the display is not operating properly.

To Avoid Personal Injury :

- Do not place the display on a sloping shelf unless properly secured.
- Use only a stand recommended by the manufacturer.
- Do not drop an object on or apply impact to the product. Do not throw any toys or objects on the product screen.
It can cause injury to human, problem to product and damage the display.

To Prevent Fire or Hazards:

- Always turn the display OFF if you leave the room for more than a short period of time. Never leave the display ON when leaving the house.
- Keep children from dropping or pushing objects into the display's cabinet openings. Some internal parts carry hazardous voltages.
- Do not add accessories that have not been designed for this display.
- When the display is to be left unattended for an extended period of time, unplug it from the wall outlet.
- In the presence of thunder and lightning, never touch the power cord and signal cable because it can be very dangerous. It can cause electric shock.

On Installation

Do not allow anything to rest upon or roll over the power cord, and do not place the display where the power cord is subject to damage.

Do not use this display near water such as near a bathtub, washbowl, kitchen sink, laundry tub, in a wet basement, or near a swimming pool.

Displays are provided with ventilation openings in the cabinet to allow the release of heat generated during operation. If these openings are blocked, built-up heat can cause failures which may result in a fire hazard. Therefore, NEVER:

- Block the bottom ventilation slots by placing the display on a bed, sofa, rug, etc.
- Place the display in a built-in enclosure unless proper ventilation is provided.
- Cover the openings with cloth or other material.
- Place the display near or over a radiator or heat source.

Do not rub or strike the Active Matrix LCD with anything hard as this may scratch, mar, or damage the Active Matrix LCD permanently.

Do not press the LCD screen with your finger for a long time as this may cause some afterimages.

Some dot defects may appear as Red, Green or Blue spots on the screen. However, this will have no impact or effect on the display performance.

If possible, use the recommended resolution to obtain the best image quality for your LCD display. If used under any mode except the recommended resolution, some scaled or processed images may appear on the screen. However, this is characteristic of the fixed-resolution LCD panel.

Leaving a fixed image on the screen for a long time may cause damage to the screen and cause image burn-in. Make sure to use a screen saver on the product. Burn-in and related problems are not covered by the warranty on this product.

Do not shock or scratch the front and sides of the screen with metallic objects. Otherwise, it may cause damage to the screen.

Make sure the panel faces forward and hold it with both hands to move. If you drop the product, the damaged product can cause electric shock or fire. Contact an authorized the service center for repair.

Avoid high temperatures and humidity.

On Cleaning

- Unplug the display before cleaning the face of the display screen.
- Use a slightly damp (not wet) cloth. Do not use an aerosol directly on the display screen because over-spraying may cause electrical shock.
- When cleaning the product, unplug the power cord and scrub gently with a soft cloth to prevent scratching. Do not clean with a wet cloth or spray water or other liquids directly onto the product. An electric shock may occur. (Do not use chemicals such as benzene, paint thinners or alcohol)
- Spray water onto a soft cloth 2 to 4 times, and use it to clean the front frame; wipe in one direction only. Too much moisture may cause staining.

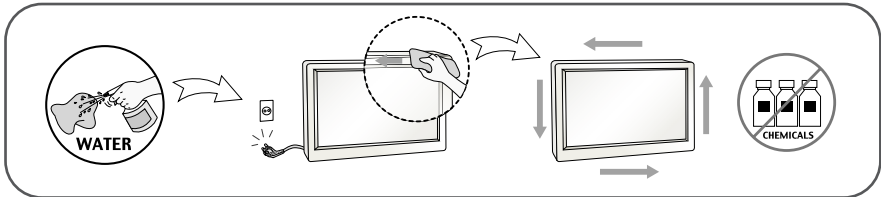

On Repacking

- Do not throw away the carton and packing materials. They make an ideal container in which to transport the unit. When shipping the unit to another location, repack it in its original material.

On Disposal (Only, Hg lamp used LCD Monitor)

- The fluorescent lamp used in this product contains a small amount of mercury.
- Do not dispose of this product with general household waste.
- Disposal of this product must be carried out in accordance to the regulations of your local authority.

- Before setting up the monitor, ensure that the power to the monitor, the computer system, and other attached devices is turned off.

Connecting the stand

1. Place the monitor with its front facing downward on a soft cloth.
2. Assemble the Stand Body into the product in the correct direction as shown in the picture. Make sure you push it until you hear it “click”.

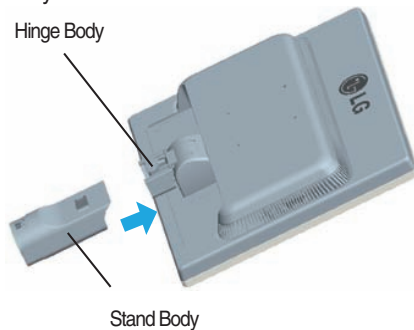

3. Assemble the Stand Base(Front, Rear) into the Stand Body in the correct direction.

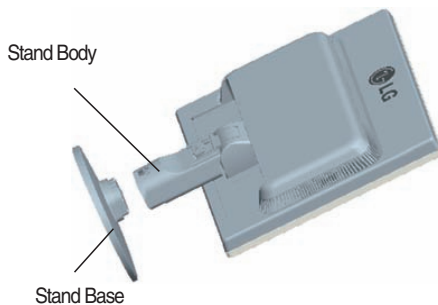

4. Tie down the base lock to perpendicularity direction.
5. Once assembled take the monitor up carefully and face the front side.

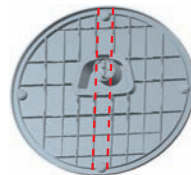

Important

- This illustration depicts the general model of connection. Your monitor may differ from the items shown in the picture.
- Do not carry the product upside down holding only the stand base. The product may fall and get damaged or injure your foot.

Disassembling the stand

1. Put a cushion or soft cloth on a flat surface.

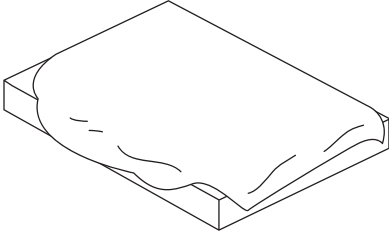

2. Place the monitor face Down on the cushion or soft cloth.



3. Change your lock on the product as it follows and turn it in the arrow direction.

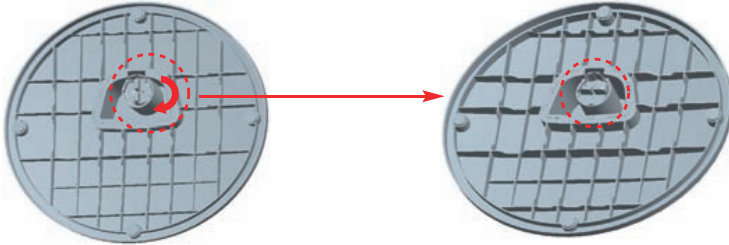

If you can't release the stand base even the locking knob is at a release position, Please push the indicated knob down and retry it.

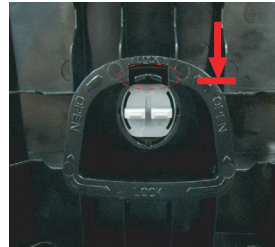

4. Pull out the Stand to remove.

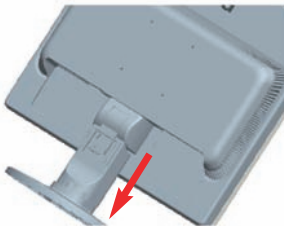

Connecting the Display

5. Pushing the PUSH button, Take the stand base from stand body.

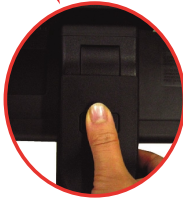
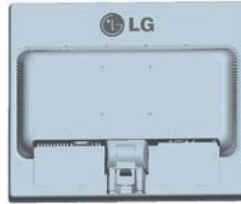

Good Position



Bad Position

Warning:
You can hurt your finger.

- Before setting up the monitor, ensure that the power to the monitor, the computer system, and other attached devices is turned off.

Positioning your display

1. Adjust the position of the panel in various ways for maximum comfort.
 - Tilt Range : -5° ~ 20°

- When adjusting the angle of the screen, do not put your finger(s) in between the head of the monitor and the stand body. You can hurt your finger(s).

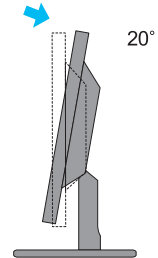
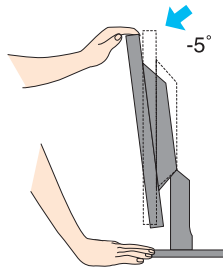

Ergonomic

It is recommended that in order to maintain an ergonomic and comfortable viewing position, the forward tilt angle of the monitor should not exceed 5 degrees.

Using the Computer

NOTE

- This is a simplified representation of the rear view.
- This rear view represents a general model; your display may differ from the view as shown.

1. **A** Connect D-sub(RGB Analog) Cable (PC)
B Connect D-sub(RGB Analog) Cable (Mac)

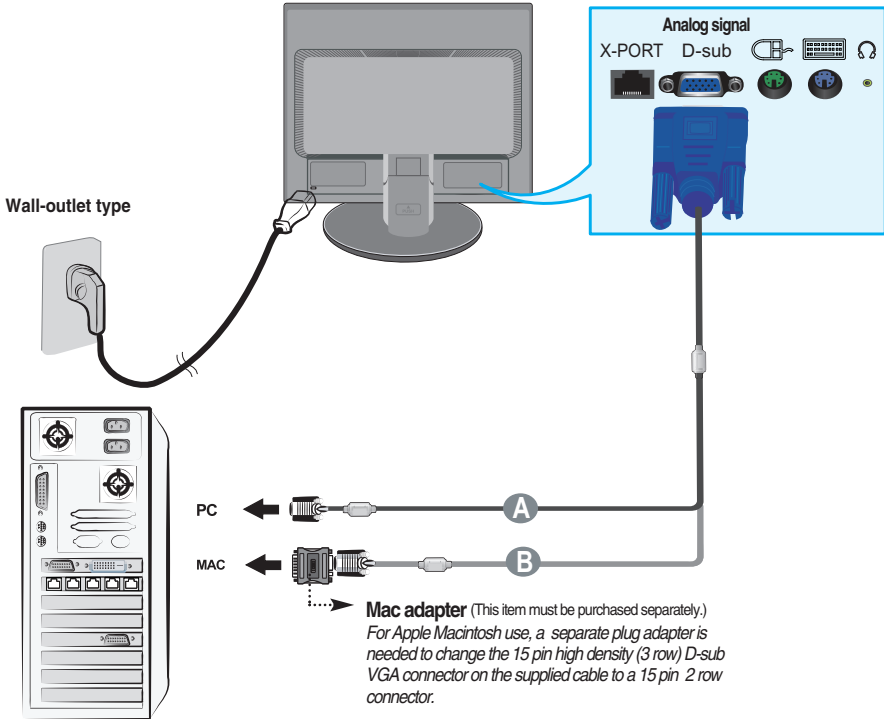

2. Press  button on the front switch panel to turn the power on. When monitor power is turned on, the 'Self Image Setting Function' is executed automatically.

PROCESSING SELF
IMAGE SETTING

NOTE

'Self Image Setting Function'? This function provides the user with optimal display settings. When the user connects the monitor for the first time, this function automatically adjusts the display to optimal settings for individual input signals.

'AUTO/SET' Function? When you encounter problems such as blurry screen, blurred letters, screen flicker or tilted screen while using the device or after changing screen resolution, press the AUTO/SET function button to improve resolution.

Using the Monitor

1. Make sure to turn off the computer and product. Connect the cable as below sketch map form ① to ② .

- ① Connect peripheral devices
- ② Connect LAN Cable (X550 port)

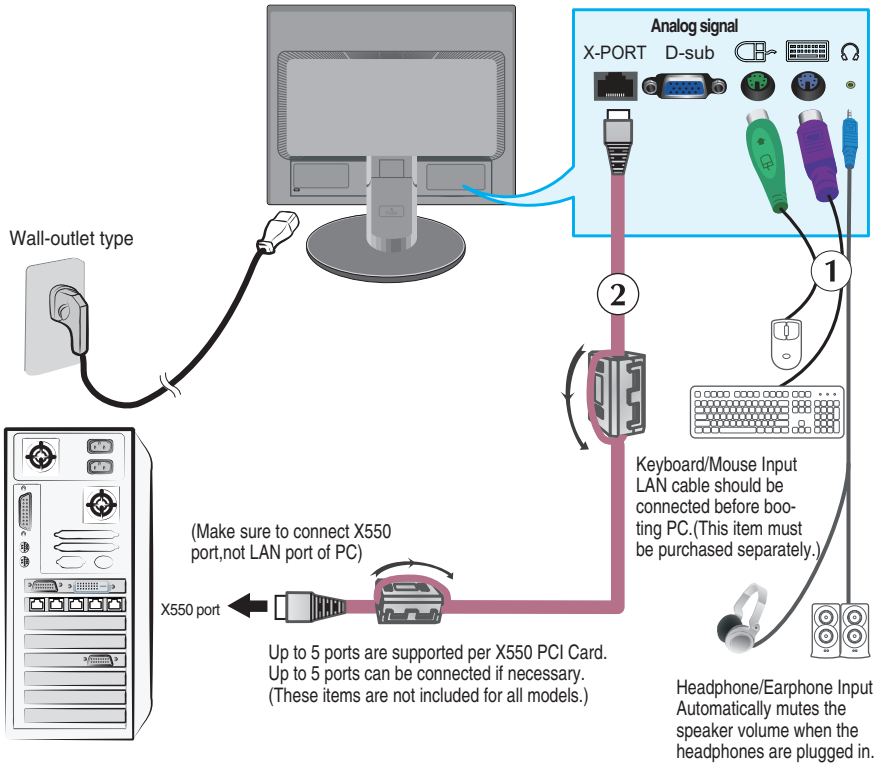

- When you use the monitor speaker via the X-POR, turn the PC volume up to the highest level and adjust the monitor volume.

- It is recommended to use a PS/2-type keyboard/mouse.

To use the monitor keyboard/mouse properly, it must be connected to the PC.

- Applications that require other than 16 bit color quality and the set resolution are not supported.
- 'AUTO/SET' Function? When you encounter problems such as blurry screen, blurred letters, screen flicker or titled screen while using the device or after changing screen resolution, press the AUTO/SET function button to improve resolution.



2. Press  button on the front switch panel to turn the power on.

NOTE

■ LAN Cable

-For the LAN cable, it is recommended to use SFTP (recommend : 6m, max : 10 m) provided by LG.

Image quality and some functionality may be degraded if a different LAN cable is used.

-To achieve good image quality, avoid using UTP and STP cables.

-You must use a direct LAN cable, not a crossover one.

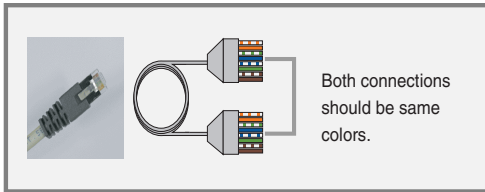

▶ Do not connect any kind of network devices.

■ Core

The ferrite core can be used to reduce electromagnetic waves when connecting a LAN cable.

As shown in the image below, fit the ferrite core to the LAN cable.

The ferrite core needs to be separated from the mold by 5 centimeters.

You can purchase SFTP (recommend : 6m, max : 10 m) LAN cables and cores through LG additionally.

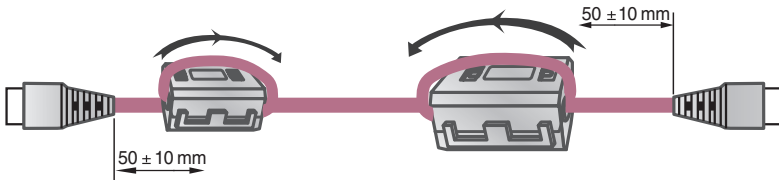

Connecting to a X550 port using a LAN cable.

Notice

- Turning the power off while booting the PC may damage the product.
- Turning the power off while booting the PC may cause it to operate incorrectly.
- If the mouse is connected using a USB device and is not detected, disconnect and connect it again.
- If you reconnect a peripheral device such as a keyboard, mouse or LAN cable while the PC is in operation, the device may not work properly.
Make sure that the power is turned off when disconnecting/connecting a peripheral device.
- Making both ends of LAN cable to across the coil two times before connect to network monitor and PC.

PC spec :

- The host PC operating system can be Windows Server 2003 R2 SP2(Standard or Enterprise Edition, 32-bit).

Notice

- To achieve the best PC performance, up to six users are recommended for one PC. If there are seven or more users, performance may be degraded depending on the environment and the PC's specifications.
- Check if the PC supports Windows Server 2003 before purchasing it.
- A host PC should have the following specifications:
 1. Minimum
 - CPU : Dual core processor at 3.0 GHz or higher
(i.e. : Intel Core 2 Duo or AMD Athlon X2)
 - RAM : 2 GB of system memory or higher
 2. Recommend
 - CPU : Quad core processor at 2.66 GHz or higher
(i.e. Intel Core 2 Quad or AMD Phenom X4)
 - RAM : 4 GB of system memory
 3. Internet access speed may be different depending on the network environment.

Restrictions :



- Using this network monitor for the following purposes may cause screen disruption or slower PC operation.
 1. Video / Moving picture
 2. Games

Color setting:

- Image quality may vary depending on the X550 card, so it is recommended to execute "White Balance" when using the product as a network monitor after connecting a LAN cable for the first time.
 - ✦ Refer to A18 for more information on White Balance.
- If you use the monitor with a X-PORT input, image quality and resolution may be poorer than with a D-sub input.
(✦ Only 16 bit color is supported for X-PORT input.)

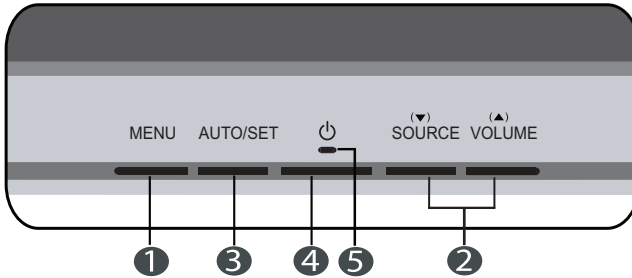
Front Panel Controls



Control	Function
1 MENU Button	Use this button to enter or exit from the On Screen Display.
 	OSD LOCKED/UNLOCKED This function allows you to lock the current control settings, so that these settings are not inadvertently changed. To lock the OSD settings, press and hold the MENU button for several seconds. The message " OSD LOCKED " appears. You can unlock the OSD settings at any time by pushing the MENU button for several seconds. The message " OSD UNLOCKED " appears.

Control	Function
<p>2 ▼ SOURCE</p> <hr/> <p>▲ VOLUME</p>	<p>Use these buttons to select or adjust functions in the On Screen Display.</p> <hr/> <p>Use this button to make either D-Sub or X-PORT connector active. This feature is used when two input sources are connected to the display.</p> <hr/> <p>Use these buttons to select or adjust functions in the On Screen Display.</p> <ul style="list-style-type: none"> • X-PORT : When X-PORT signal is active, Use ▼ ▲ button to decrease or increase the speaker volume on X-PORT input. <div data-bbox="591 576 820 647" data-label="Image"> </div> <ul style="list-style-type: none"> • D-sub : This menu is not available. <div data-bbox="555 708 944 762" data-label="Image"> </div>
<p>3 AUTO/SET Button</p> <div data-bbox="202 1107 420 1193" data-label="Image"> </div>	<p>Use this button to enter a selection in the On Screen Display.</p> <hr/> <p>AUTO IMAGE ADJUSTMENT</p> <p>When adjusting your display settings, always press the AUTO/SET button before entering the On Screen Display(OSD). This will automatically adjust your display image to the ideal settings for the current screen resolution size (display mode).</p> <p>The best display mode is</p> <p>17 inches : 1280 x 1024(D-sub) / 1024 x 768 (X-PORT)</p> <p>19 inches : 1280 x 1024(D-sub) / 1024 x 768 (X-PORT)</p>
<p>4 Power Button</p>	<p>Use this button to turn the display on or off.</p>
<p>5 Power Indicator</p>	<p>This Indicator lights up blue when the display operates normally(On Mode). If the display is in Sleep Mode (Energy Saving), this indicator color changes to flicker.</p>

Screen Adjustment

Making adjustments to the image size, position and operating parameters of the display is quick and easy with the On Screen Display Control system. A short example is given below to familiarize you with the use of the controls. The following section is an outline of the available adjustments and selections you can make using the OSD.

NOTE

- Allow the display to stabilize for at least 30 minutes before making image adjustments.

To make adjustments in the On Screen Display, follow these steps:

MENU → ▼ ▲ → AUTO/SET → ▼ ▲ → MENU

- 1** Press the MENU Button, then the main menu of the OSD appears.
- 2** To access a control, use the ▼ or ▲ Buttons. When the icon you want becomes highlighted, press the AUTO/SET Button.
- 3** Use the ▼ / ▲ Buttons to adjust the image to the desired level. Use the AUTO/SET Button to select other sub-menu items.
- 4** Push the MENU Button once to return to the main menu to select another function. Push the MENU Button twice to exit from the OSD.

On Screen Display(OSD) Selection and Adjustment

The following table indicates all the On Screen Display control, adjustment, and setting menus.

Main menu	Sub-menu		A	X	Reference
PICTURE	BRIGHTNESS		●	●	To adjust the brightness, contrast and gamma of the screen
	CONTRAST		●	●	
	GAMMA		●	●	
COLOR	PRESET	sRGB	●	●	To customize the color of the screen
		6500K	●	●	
		9300K	●	●	
	RED		●	●	
	GREEN		●	●	
	BLUE		●	●	
POSITION	HORIZONTAL		●	●	To adjust the position of the screen
	VERTICAL		●	●	
TRACKING	CLOCK		●	●	To improve the clarity and stability of the screen
	PHASE		●	●	
	SHARPNESS		●	●	
SETUP	LANGUAGE		●	●	To customize the screen status for a user's operating environment
	OSD POSITION	HORIZONTAL	●	●	
		VERTICAL	●	●	
	WHITE BALANCE		●	●	
	POWER INDICATOR		●	●	
	FACTORY RESET		●	●	
FLATRON F·ENGINE	MOVIE		●		To select or customize desired image settings
	INTERNET		●	●	
	USER	ACE	●		
		RCM	●		
	NORMAL		●	●	
	DEMO		●		
				● : Adjustable A : D-SUB Input X : X-POR T Input	

NOTE

- The order of icons may differ depending on the model (A14~A19).

On Screen Display(OSD) Selection and Adjustment

You were introduced to the procedure of selecting and adjusting an item using the OSD system. Listed below are the icons, icon names, and icon descriptions of the all items shown on the Menu.

Press the MENU Button, then the main menu of the OSD appears.

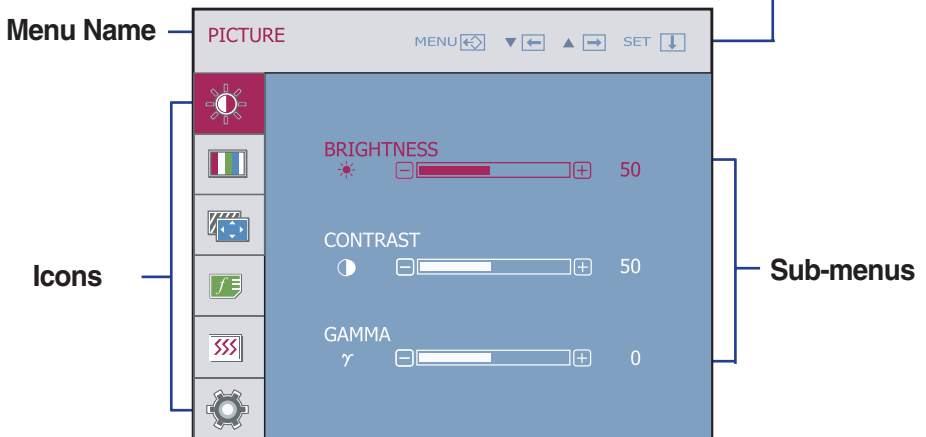
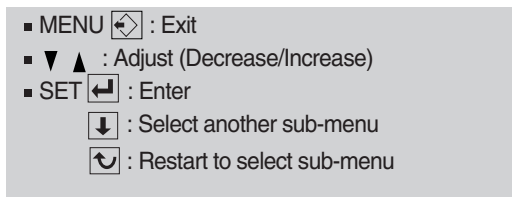
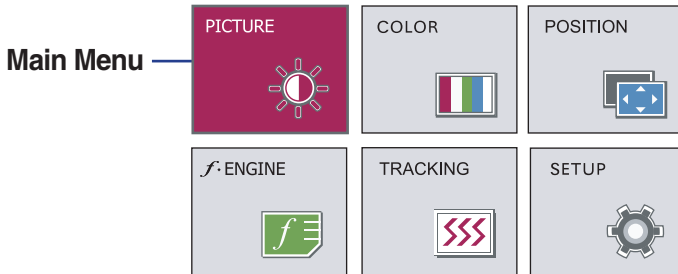

NOTE

- OSD (On Screen Display) menu languages on the monitor may differ from the manual.

On Screen Display(OSD) Selection and Adjustment

Main menu	Sub menu	Description
-----------	----------	-------------



PICTURE

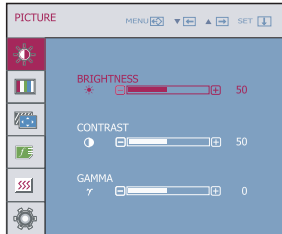

BRIGHTNESS

To adjust the brightness of the screen.

CONTRAST

To adjust the contrast of the screen.

GAMMA

Set your own gamma value. : -50/0/50
On the monitor, high gamma values display whitish images and low gamma values display blackish images.

- **MENU** : Exit
- **▼** : Decrease
- **▲** : Increase
- **SET** : Select another sub-menu



COLOR

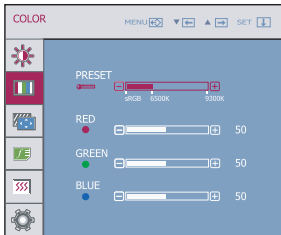

PRESET

- sRGB: Set the screen color to fit the SRGB standard color specification.
- 6500K: Slightly reddish white.
- 9300K: Slightly bluish white.

RED

Set your own red color levels.

GREEN

Set your own green color levels.

BLUE

Set your own blue color levels.

- **MENU** : Exit
- **▼** : Decrease
- **▲** : Increase
- **SET** : Select another sub-menu

Main menu	Sub menu	Description
-----------	----------	-------------



POSITION

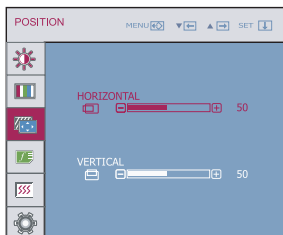

HORIZONTAL To move image left and right.

VERTICAL To move image up and down.

- **MENU** : Exit
- **▼** : Decrease
- **▲** : Increase
- **SET** : Select another sub-menu



TRACKING

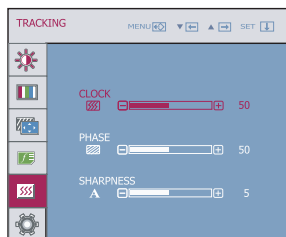

CLOCK To minimize any vertical bars or stripes visible on the screen background. The horizontal screen size will also change.

PHASE To adjust the focus of the display. This item allows you to remove any horizontal noise and clear or sharpen the image of characters.

SHARPNESS To adjust the clearness of the screen.

- **MENU** : Exit
- **▼** : Decrease
- **▲** : Increase
- **SET** : Select another sub-menu

On Screen Display(OSD) Selection and Adjustment

Main menu	Sub menu	Description
-----------	----------	-------------



SETUP

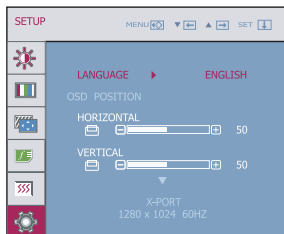

LANGUAGE

To choose the language in which the control names are displayed.

OSD POSITION

To adjust position of the OSD window on the screen.

WHITE BALANCE

If the output of the video card is different from the required specifications, the color level may deteriorate due to video signal distortion. Using this function, the signal level is adjusted to fit into the standard output level of the video card in order to provide the optimal image. Activate this function when white and black colors are present in the screen.

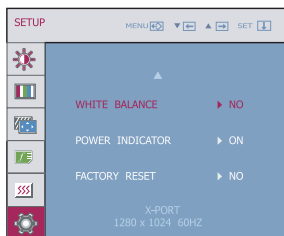

POWER INDICATOR

Use this function to set the power indicator on the front side of the monitor to **ON** or **OFF**. If you set **OFF**, it will go off. If you set **ON** at any time, the power indicator will automatically be turned on.

FACTORY RESET

Restore all factory default settings except "LANGUAGE". Press the ▼,▲ buttons to reset immediately.

- **MENU** : Exit
- ▼ : Adjust
- ▲ : Adjust
- **SET** : Select another sub-menu

If this does not improve the screen image, restore the factory default settings. If necessary, perform the white balance function again. This function will be enabled only when the input signal is a D-sub or X-PORt input signal.

On Screen Display(OSD) Selection and Adjustment

Main menu	Sub menu	Description
-----------	----------	-------------



f. ENGINE

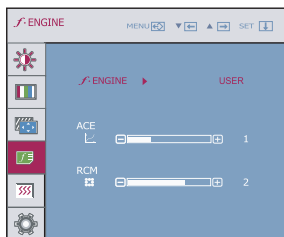

MOVIE This feature lets you easily select the best desired image condition optimized to the environment (ambient illumination, image types etc).

MOVIE: For animation images in videos or movies

INTERNET: For text images (Word processing etc.)

USER User

You can manually adjust **ACE** or **RCM**.

You can save or restore the adjusted value even when using a different environment.

- **MENU** : Exit
- ▼ : Decrease
- ▲ : Increase
- **SET** : Select another sub-menu

...**ACE**(Adaptive Clarity Enhancer): Selects the clarity mode.

...**RCM**(Real Color Management): Selects the color mode.

	0	Not applied
	1	Green enhance
	2	Flesh tone
	3	Color Enhance

NORMAL This is under normal operating conditions.

DEMO This is just for advertising to customer in the shops. It's setting is same with Movie mode and screen is divided by half.

❖ The INTERNET and NORMAL features become enabled for X-PORT input.

Check the following before calling for service.

No image appears

- | | |
|---|---|
| <ul style="list-style-type: none">● Is the power cord of the display connected?● Is the power indicator light on?● Is the power indicator flickering?● Do you see an "OUT OF RANGE" message on the screen?● Do you see a "CHECK SIGNAL CABLE" message on the screen? | <ul style="list-style-type: none">• Check and see if the power cord is connected properly to the power outlet.• Press the Power button.• If the display is in power saving mode, try moving the mouse or pressing any key on the keyboard to bring up the screen.• Try to turn on the PC.• This message appears when the signal from the PC (video card) is out of horizontal or vertical frequency range of the display. See the 'Specifications' section of this manual and configure your display again.• This message appears when the signal cable between your PC and your display is not connected. Check the signal cable and try again. |
|---|---|

Do you see a "OSD LOCKED" message on the screen?

- | | |
|---|--|
| <ul style="list-style-type: none">● Do you see "OSD LOCKED" when you push MENU button? | <ul style="list-style-type: none">• You can secure the current control settings, so that they cannot be inadvertently changed. You can unlock the OSD controls at any time by pushing the MENU button for several seconds: the message "OSD UNLOCKED" will appear. |
|---|--|

Display image is incorrect

- | | |
|---|--|
| <ul style="list-style-type: none">● Display Position is incorrect. | <ul style="list-style-type: none">● Press the AUTO/SET button to automatically adjust your display image to the ideal setting. If the results are unsatisfactory, adjust the image position using the H position and V position icon in the on screen display. |
| <ul style="list-style-type: none">● On the screen background, vertical bars or stripes are visible. | <ul style="list-style-type: none">● Press the AUTO/SET button to automatically adjust your display image to the ideal setting. If the results are unsatisfactory, decrease the vertical bars or stripes using the CLOCK icon in the on screen display. |
| <ul style="list-style-type: none">● Any horizontal noise appearing in any image or characters are not clearly portrayed. | <ul style="list-style-type: none">● Press the AUTO/SET button to automatically adjust your display image to the ideal setting. If the results are unsatisfactory, decrease the horizontal bars using the PHASE icon in the on screen display.● Check Control Panel --> Display --> Settings and adjust the display to the recommended resolution or adjust the display image to the ideal setting. Set the color setting higher than 24 bits (true color).(Only for D-SUB Input) |

Important

- Check **Control Panel --> Display --> Settings** and see if the frequency or the resolution were changed. If yes, readjust the video card to the recommend resolution.(Only for D-SUB Input)
- The setting method can differ by computer and O/S (Operation System), and resolution mentioned above may not be supported by the video card performance. In this case, please ask to the computer or the video card manufacturer. (Only for D-SUB Input)

Display image is incorrect

- **The screen color is mono or abnormal.**

- Check if the signal cable is properly connected and use a screwdriver to fasten if necessary.
- Make sure the video card is properly inserted in the slot.
- Set the color setting higher than 24 bits (true color) at **Control Panel - Settings**.
(X-PORT support only 16bits color)
 - "White Balance" is performed on black/white pattern.
 - Check if the screen is set to normal mode.

- **The screen blinks.**

- Check if the screen is set to interlace mode and if yes, change it to the recommend resolution.
 - Check if the screen is set to normal mode.

Display	17 inches (43.2 cm) Flat Panel Active matrix-TFT LCD, Anti-Glare coating Visible diagonal size: 43.2 cm 0.264 mm pixel pitch		
Sync Input	D-SUB	Horizontal Freq.	30 - 66 kHz (Automatic)
		Vertical Freq.	57 - 63 Hz (Automatic)
	D-SUB support 60Hz only(except Dos mode)		
X-PORT	1440 x 900 (60Hz)	1280 x 720 (60Hz)	
	1280 x 1024 (60Hz)	800 x 600 (72Hz)	
	1024 x 768 (60Hz)		
Video Input	D-SUB	Signal Input	15 pin D-Sub Connector
		Input Form	RGB Analog (0.7 Vp-p/ 75 ohm)
X-PORT	Signal Input	X-PORT Connector	
	Input Form	X-PORT Signal	
Resolution	Max	VESA 1280 x 1024 @60 Hz	
	Recommend	D-SUB	VESA 1280 x 1024 @60 Hz
		X-PORT	VESA 1024 x 768 @60 Hz
Plug&Play	DDC 2B (Only for D-SUB Input)		
Power Consumption	On Mode	:	32 W(Typ.)
	Sleep Mode	≤	1 W
	Off Mode	≤	1 W
Dimensions & Weight		With Stand	
		Without Stand	
	Width	36.96 cm / 14.55 inches	36.96 cm / 14.55 inches
	Height	39.13 cm / 15.41 inches	31.51 cm / 12.41 inches
	Depth	18.48 cm / 7.28 inches	5.90 cm / 2.32 inches
Net	3.1 kg (6.89 lbs)		
Tilt Range	Tilt	-5° ~ 20°	
Power Input	AC 100-240V~ 50/60Hz 0.8A		
Environmental Conditions	Operating Conditions		
	Temperature	10°C to 35 °C	
	Humidity	10 % to 80 % non-Condensing	
	Storage Conditions		
Temperature	-20°C to 60 °C		
Humidity	5 % to 90 % non-Condensing		
Stand Base	Attached (<input type="checkbox"/>), Detached (<input type="checkbox"/>)		
Power cord	Wall-outlet type		

NOTE

- Information in this document is subject to change without notice.

Display	19 inches (48.2 cm) Flat Panel Active matrix-TFT LCD, Anti-Glare coating Visible diagonal size: 48.2 cm 0.294 mm pixel pitch		
Sync Input	D-SUB	Horizontal Freq.	30 - 66 kHz (Automatic)
		Vertical Freq.	57 - 63 Hz (Automatic)
	D-SUB support 60Hz only(except Dos mode)		
Video Input	X-PORT	1440 x 900 (60Hz)	1280 x 720 (60Hz)
		1280 x 1024 (60Hz)	800 x 600 (72Hz)
		1024 x 768 (60Hz)	
Video Input	D-SUB	Signal Input Input Form	15 pin D-Sub Connector RGB Analog (0.7 Vp-p/ 75 ohm)
	X-PORT	Signal Input Input Form	X-PORT Connector X-PORT Signal
Resolution	Max	VESA 1280 x 1024 @60 Hz	
	Recommend	D-SUB	VESA 1280 x 1024 @60 Hz
		X-PORT	VESA 1024 x 768 @60 Hz
Plug&Play	DDC 2B (Only for D-SUB Input)		
Power Consumption	On Mode	:	40 W(Max.)
	Sleep Mode	≤	1 W
	Off Mode	≤	1 W
Dimensions & Weight	With Stand		Without Stand
	Width	40.63 cm / 16.00 inches	40.63 cm / 16.00 inches
	Height	41.97 cm / 16.52 inches	34.45 cm / 13.56 inches
	Depth	18.48 cm / 7.28 inches	5.99 cm / 2.36 inches
	Net	3.5 kg (7.78 lbs)	
Tilt Range	Tilt	-5° ~ 20°	
Power Input	AC 100-240V~ 50/60Hz 0.8A		
Environmental Conditions	Operating Conditions		
	Temperature	10°C to 35 °C	
	Humidity	10 % to 80 % non-Condensing	
	Storage Conditions		
	Temperature	-20°C to 60 °C	
	Humidity	5 % to 90 % non-Condensing	
Stand Base	Attached (<input type="checkbox"/>), Detached (<input type="checkbox"/>)		
Power cord	Wall-outlet type		

NOTE

- Information in this document is subject to change without notice.

D-SUB Preset Modes (Resolution)

Display Modes (Resolution)		Horizontal Freq. (kHz)	Vertical Freq. (Hz)
1	640 x 350	31.469	70
2	720 x 400	31.468	70
3	640 x 480	31.469	60
4	800 x 600	37.879	60
5	1024 x 768	48.363	60
*6	1280 x 1024	63.981	60

*Recommend Mode

X-PORT Preset Modes (Resolution)

Display Modes (Resolution)	
1	800 x 600(72Hz)
*2	1024 x 768(60Hz)
3	1280 x 720(60Hz)
4	1280 x 1024(60Hz)
5	1440 x 900(60Hz)

*Recommend Mode

Indicator

MODE	LED Color
On Mode	Blue
Sleep Mode	Flicker
Off Mode	Off

Installing the Wall mount plate

This monitor satisfies the specifications of the Wall mount plate or the interchange device.

1. Place the monitor with its front facing downward on a soft cloth.



2. Separate the stand by pushing the PUSH button.

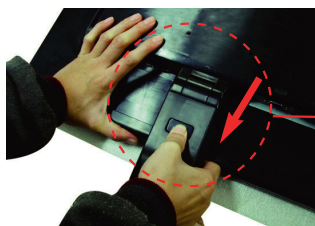

Good Position



Bad Position

Warning:

You can hurt your finger.

3. Install the Wall mount plate.

Wall mount plate (Separate purchase)

This is stand-type or wall mount type and is connectable with Wall mount plate. Please refer to the installation guide for more details, which is provided when Wall mount plate is purchased. LG recommends that wall mounting be performed by a qualified professional installer.

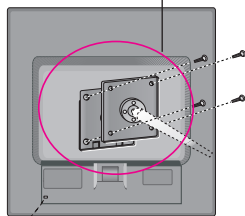

Kensington Security Slot

Connected to a locking cable that can be purchased separately at most computer stores.

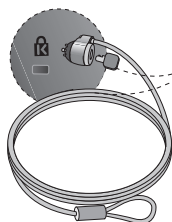

Digitally yours■■■■.....

