

Xtreme Mix™

309535L

ENG

**Plural Component Mixer with stand. For professional use only.
Not approved for use in explosive atmospheres.**



Important Safety Instructions

Read all warnings and instructions in this manual.
Save these instructions.

See page 3 for model information, including maximum working pressure and approvals.

United States Patent Number: 6,896,152
Chinese Patent Number: ZL02823545.2
Korean Patent Number: 10-0967987
European Patent Numbers: 126418, 145567, 1762138

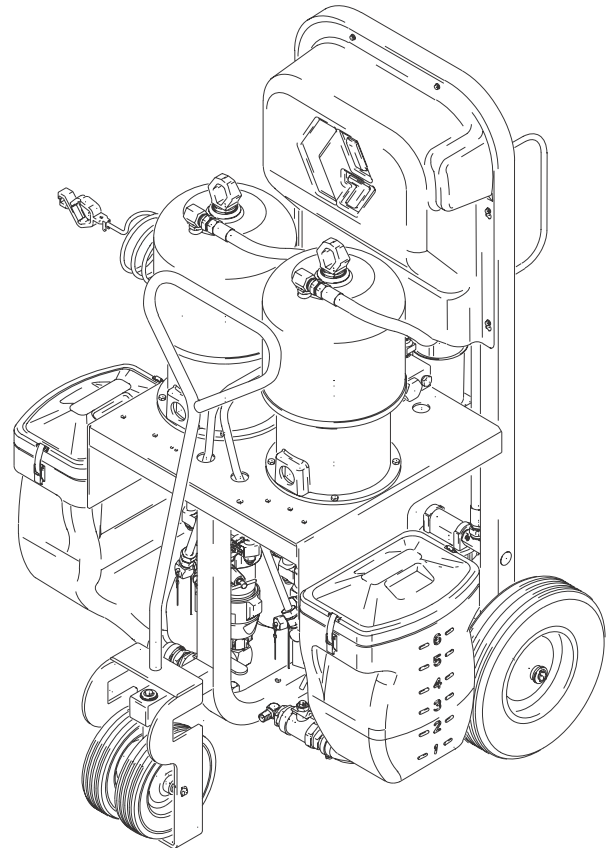

Contents

Related Documentation	2	Spraying	22
Xtreme Mix Models	3	Mix and Integration Tests	23
Manual Conventions	4	Batch Dispense or Ratio Check	24
Warnings	5	Pump Cycle Counter	25
Overview	8	Circulation Setting	25
Pressure Relief Procedure	10	Shutdown	25
Proper Lifting of Unit	11	Alarms	26
Setup	11	Performance Charts	27
Flushing	14	Technical Data	31
Priming	18	Graco Standard Warranty	32
Pump Test	20	Graco Information	32

Related Documentation

Component Manuals

Manual	Description
309518	Xtreme Mix Repair
311762	Xtreme Displacement Pump
309347 or 309348	King Air Motor King Quiet Air Motor
312145	XTR Spray Gun
309524	VISCON HP Heater
309525	Heated Hose Kit
308981	Husky 716 Diaphragm Pump
309615	Heater Bracket Kit
309568	Remote Manifold Kit
310797	Remote Mix Manifold
310794	Remote Mix Proportioning Systems
310863	Feed and Flush Kits
309827	Air Supply Kits

This manual available in following languages:

Manual	Language	Manual	Language
309535	English	309600	Swedish
309536	French	309601	Chinese
309537	Brazilian Portuguese	309602	Korean
309545	Spanish	309603	Japanese
309596	German	310754	Dutch
309597	Greek	310755	Norwegian
309598	Italian	310756	Danish
309599	Finnish		

Alarm Code Labels:

Part No.	Languages
15B843	Chinese, Finnish, Portuguese, Greek, Swedish, Italian
15B844	English, Spanish, French, German, Korean, Japanese

Xtreme Mix Models



WARNING



Do not install equipment approved only for non-hazardous location in a hazardous area. Substitution of components may impair intrinsic safety. See page 5.

Approved for Non-hazardous Location



Xtreme Mix Part No.	Series	Pump Part No.	Pump Description	Maximum Working Pressure psi (MPa, bar)	Approvals
233863	A	249274	45:1 King	4500 (31, 310)	CE
233864	A	249275	56:1 King	5600 (38.6, 386)	
233865	A	249276	68:1 King	6800 (46.9, 469)	
233866	A	249277	80:1 King	7250 (50, 500)	
233867	A	249278	45:1 Quiet King	4500 (31, 310)	
233868	A	249279	56:1 Quiet King	5600 (38.6, 386)	
233869	A	249280	68:1 Quiet King	6800 (46.9, 469)	
233870	A	249281	80:1 Quiet King	7250 (50, 500)	
*248842	A	249276	68:1 King Remote Mix	5000 (34.5, 345)	



*Model 248842 is designed for remote feed pumps and a remote mix manifold. It does not include hoppers, mix manifold, hose, or spray gun. Refer to manual 310794 for application layout.

Model 248842 is limited to 5000 psi (34.5 MPa, 345 bar) for use in “quick set” packages where heated hoses, whip hoses, and spray accessories are limited to 5000 psi (34.5 MPa, 345 bar). If all your downstream components are rated for 7000 psi (48 MPa, 483 bar), you can replace the standard relief valve with relief valve 113498.

Manual Conventions

 WARNING
 Hazard Symbol
WARNING: a potentially hazardous situation which, if not avoided, could result in death or serious injury. Warnings in the instructions usually include a symbol indicating the hazard. Read the general Warnings section for additional safety information.

CAUTION
CAUTION: a potentially hazardous situation which, if not avoided, may result in property damage or destruction of equipment.

Note

 Additional helpful information.

Components A and B

IMPORTANT!

Material supplier s can vary in how they refer to plural component materials.





Be aware that in this manual:







Component A refers to resin or major volume.

Component B refers to catalyst (curing agent) or minor volume.

Warnings

The following general warnings are related to the safe setup, use, grounding, maintenance, and repair of this equipment. Additional more specific warnings may be found throughout the text of this manual where applicable.

 Warning	
	<p>FIRE AND EXPLOSION HAZARD</p> <p>Flammable fumes, such as solvent and paint fumes, in work area can ignite or explode. To help prevent fire and explosion:</p> <ul style="list-style-type: none"> • Use equipment only in well ventilated area. • Eliminate all ignition sources; such as pilot lights, cigarettes, portable electric lamps, and plastic drop cloths (potential static arc). • Keep work area free of debris, including solvent, rags and gasoline. • Do not plug or unplug power cords, or turn power or light switches on or off when flammable fumes are present. • Ground equipment and conductive objects in work area. See Grounding instructions. • Use only grounded hoses. • Hold gun firmly to side of grounded pail when triggering into pail. • If there is static sparking or you feel a shock, stop operation immediately. Do not use equipment until you identify and correct the problem. • Keep a fire extinguisher in the work area.
	<p>ELECTRIC SHOCK HAZARD</p> <p>Improper grounding, setup, or usage of the system can cause electric shock.</p> <ul style="list-style-type: none"> • Turn off and disconnect power at main switch before disconnecting any cables and before servicing equipment. • Connect only to grounded power source. • All electrical wiring must be done by a qualified electrician and comply with all local codes and regulations.
	<p>SKIN INJECTION HAZARD</p> <p>High-pressure fluid from gun, hose leaks, or ruptured components will pierce skin. This may look like just a cut, but it is a serious injury that can result in amputation. Get immediate surgical treatment.</p> <ul style="list-style-type: none"> • Do not point gun at anyone or at any part of the body. • Do not put your hand over the spray tip. • Do not stop or deflect leaks with your hand, body, glove, or rag. • Do not spray without tip guard and trigger guard installed. • Engage trigger lock when not spraying. • Follow Pressure Relief Procedure in this manual, when you stop spraying and before cleaning, checking, or servicing equipment.
	<p>MOVING PARTS HAZARD</p> <p>Moving parts can pinch or amputate fingers and other body parts.</p> <ul style="list-style-type: none"> • Keep clear of moving parts. • Do not operate equipment with protective guards or covers removed. • Pressurized equipment can start without warning. Before checking, moving, or servicing equipment, follow the Pressure Relief Procedure in this manual. Disconnect power or air supply.

 Warning	
	<p>EQUIPMENT MISUSE HAZARD</p> <p>Misuse can cause death or serious injury.</p> <ul style="list-style-type: none"> • Do not exceed the maximum working pressure or temperature rating of the lowest rated system component. See Technical Data in all equipment manuals. • Use fluids and solvents that are compatible with equipment wetted parts. See Technical Data in all equipment manuals. Read fluid and solvent manufacturer's warnings. • Check equipment daily. Repair or replace worn or damaged parts immediately. • Do not alter or modify equipment. • For professional use only. • Use equipment only for its intended purpose. Call your Graco distributor for information. • Route hoses and cables away from traffic areas, sharp edges, moving parts, and hot surfaces. • Do not kink or overbend hoses or use hoses to pull equipment. • Comply with all applicable safety regulations.
	<p>BURN HAZARD</p> <p>Equipment surfaces and fluid that's heated can become very hot during operation. To avoid severe burns, do not touch hot fluid or equipment. Wait until equipment/fluid has cooled completely.</p>
	<p>TOXIC FLUID OR FUMES HAZARD</p> <p>Toxic fluids or fumes can cause serious injury or death if splashed in the eyes or on skin, inhaled, or swallowed.</p> <ul style="list-style-type: none"> • Read MSDS's to know the specific hazards of the fluids you are using. • Store hazardous fluid in approved containers, and dispose of it according to applicable guidelines.
	<p>PERSONAL PROTECTIVE EQUIPMENT</p> <p>You must wear appropriate protective equipment when operating, servicing, or when in the operating area of the equipment to help protect you from serious injury, including eye injury, inhalation of toxic fumes, burns, and hearing loss. This equipment includes but is not limited to:</p> <ul style="list-style-type: none"> • Protective eyewear • Clothing and respirator as recommended by the fluid and solvent manufacturer • Gloves • Hearing protection
	<p>RECOIL HAZARD</p> <p>Gun may recoil when triggered and cause you to fall and be seriously injured if you are not standing securely.</p>



A series of horizontal lines spanning the width of the page, providing a template for writing or drawing.

Overview

Usage







The Xtreme Mix can mix most two-component epoxy and urethane paints. Only Model 248842 is for use with “quick-setting” paints (those with a pot life of less than 15 minutes). Other models cannot be used with such paints without modification. Contact your distributor for information.

The Xtreme Mix is operated with the User Interface, Air Controls and Fluid Controls, described below and on page 9. Refer to FIG. 1 and FIG. 2.

User Interface

The User Interface has 6 main interfaces.

1. **Knob** to select functions:

Icon	Function
	<i>Spray</i> : proportion and spray material
	<i>Run pump A</i> : operate pump A independent of pump B (priming, flushing) for 12 cycles
	<i>Run pump B</i> : operate pump B independent of pump A (priming, flushing) for 12 cycles
	<i>Batch Dispense</i> : dispense proportioned amounts of A and B
	<i>Pump Test</i> : dispense predetermined amount of A and B to verify pump operation and metering
	<i>Cycle Counter</i> : totalize A and B pump cycles

 When run independently, A and B light indicators (L) will show which pump is running.



2. **Start button**  to initiate functions

3. **Stop button**  to terminate functions
4. **Key switch** to change ratio or reset pump cycle counter
5. **Display** (five-digits) to view:
 - Ratio
 - Alarm codes
 - Pump cycles

 The display includes an alarm code label in English. See page 2 to order additional languages.

6. **Data port** allows for connection to a PC serial port to download cycle count, operation, ratio setting, and error alarm data.

WARNING

The PC must be in a non-hazardous location and a safety barrier must be installed between the PC and Xtreme Mix unit. See Xtreme Mix software manual.

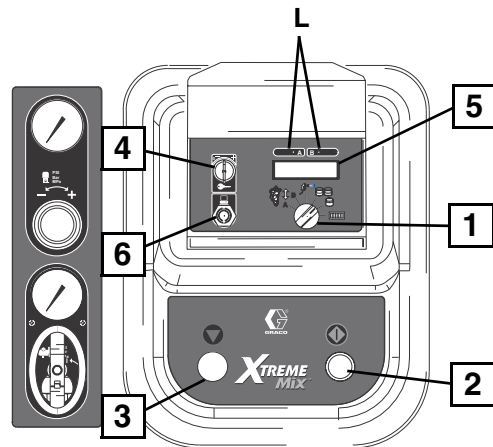



FIG. 1

Air Controls

- A. Main air shutoff valve (bleed-type)** to shutoff all air to Xtreme Mix (including controller power)
- B. Supply air pressure gauge** to monitor air pressure to Xtreme Mix

 A minimum air pressure supply of 50 psi (0.35 MPa, 3.5 bar) must be maintained for the Xtreme Mix to operate properly.

- C. Pump air pressure regulator** with gauge to adjust and monitor pump air pressure

 Push in regulator knob to lock setting. Be careful when pulling knob out to change setting as knob is removable. To reinstall, push knob to snap into place.

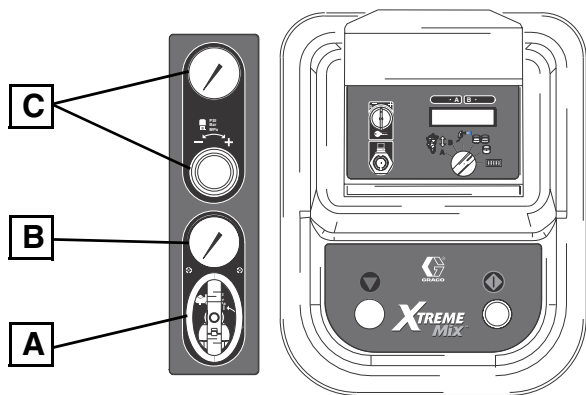

FIG. 2

Solenoid Module

There are 4 solenoids inside the controller.

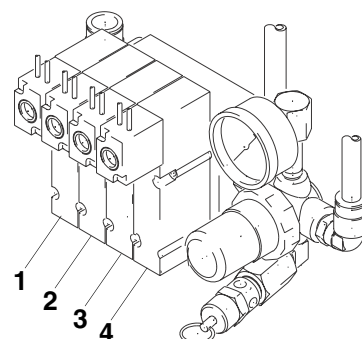



FIG. 3

Solenoid	ON/OFF for:
1	Metering valve A
2	Metering valve B
3	Pilot valve A - turns pump A ON/OFF
4	Pilot valve B - turns pump B ON/OFF

Fluid Controls

- D. Sampling valves A and B** to batch dispense or test pumps
- E. Shutoff valves A and B** to shutoff fluid A or B from entering the fluid manifold

 There are 2 metering valves, one for fluid A (F1) and one for fluid B (F2). The metering valves are turned on and off by solenoids 1 and 2.

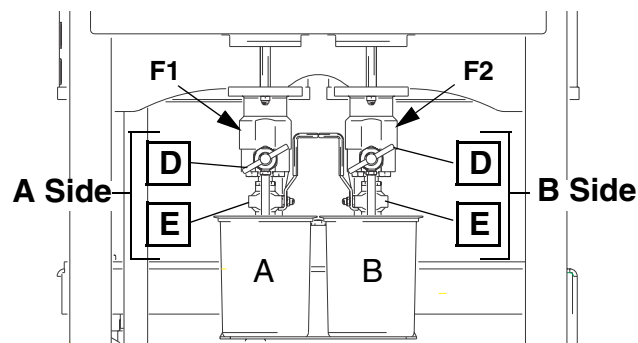



FIG. 4

ti2249a

Pressure Relief Procedure

WARNING



Follow **Pressure Relief Procedure** when you stop spraying and before cleaning, checking, servicing, or transporting equipment. Read warnings, page 5.

1. Engage trigger lock.

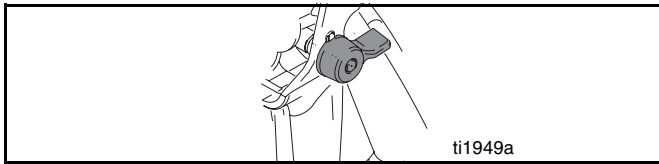

2. Press Stop .

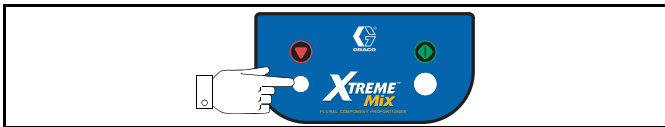

3. Close main air shutoff valve on air supply line and on unit. Turn off air regulator.
4. Close fluid sampling and shutoff valves A and B.

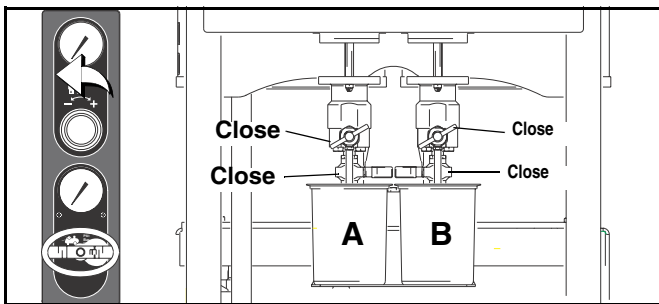

5. Disengage trigger lock.

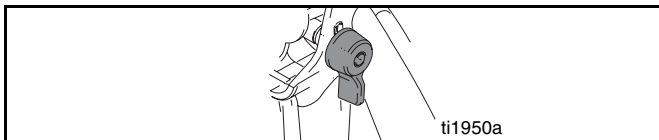

6. Hold a metal part of the gun firmly to a grounded metal pail. Trigger gun to relieve pressure.

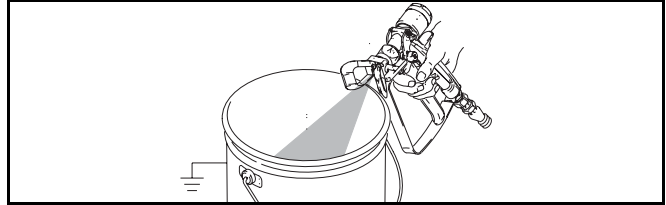

7. Engage trigger lock.



8. Place waste container under sampling valves, then open valves A and B slowly to relieve pressure between pump and metering valves.

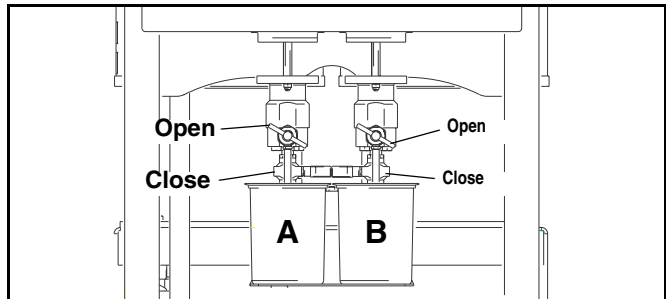

9. Close sampling valve A and B.

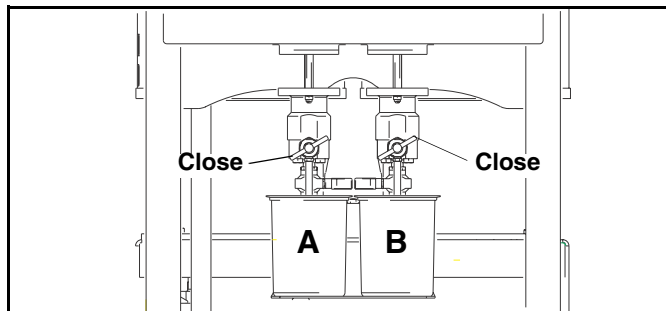

Proper Lifting of Unit

⚠ WARNING



Follow instructions below to avoid dropping or swinging unit or being struck by the cart handle, which can cause serious injury or damage to equipment.

Either remove the cart handle or secure it to the cart before lifting the unit. Connect a bridle swing, hooking an end to each of the Xtreme Mix air motor rings. Hook the center ring on a hoist. See FIG. 5. Carefully lift the Xtreme Mix unit; make sure it balances evenly.

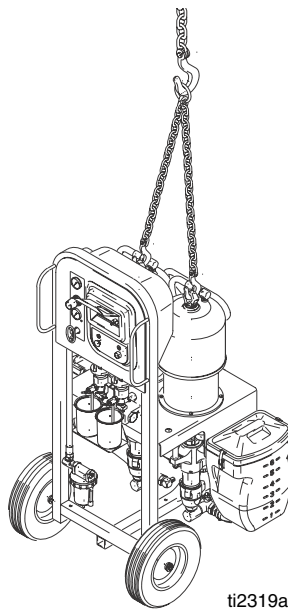

FIG. 5

Setup

⚠ WARNING



Do not install equipment approved only for non-hazardous location in a hazardous area. Substitution of components may impair intrinsic safety. Read warnings, page 5. Ground equipment as instructed below.

If connecting PC for data download, PC must be in non-hazardous location and a safety barrier must be installed. See Xtreme Mix software documentation.

- 1. Grounding:** Connect Xtreme Mix ground wire clamp (G) to a true earth ground.

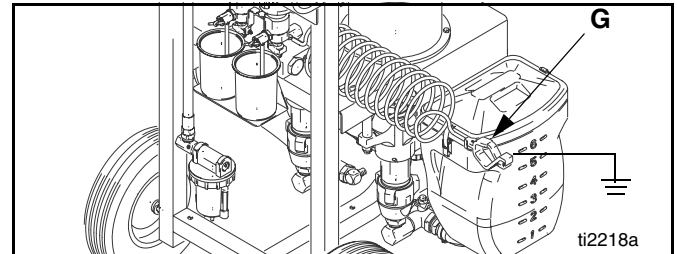

- 2. Model 248842 Only:** This model uses a remote mix manifold, which is connected to the unit by at least 50 ft. (15 m) of individual fluid hoses. Refer to manuals 310794 and 310797 for typical setups.

All Other Models: The 50 ft. (15 m) fluid hose (W), static mixer (X), whip hose (Y), and gun (Z) come assembled. Note the order of connection.

⚠ CAUTION

Do not assemble static mixer (X) directly to fluid manifold. Install static mixer after first 50 ft. (15 m) of hose to ensure material is completely mixed. Spraying unmixed material could necessitate rework of part sprayed.

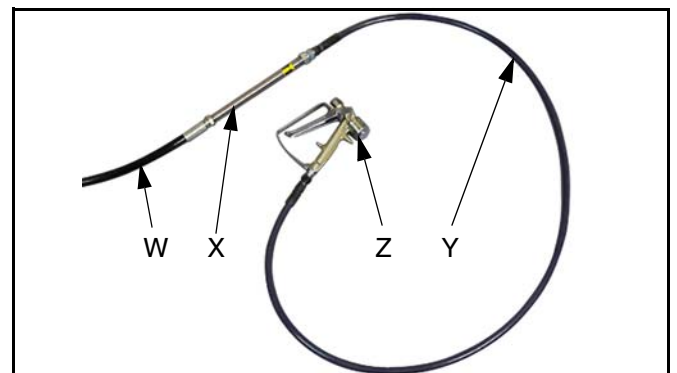

3. Connect the fluid hose (W) to the fluid manifold outlet (J). Do not install gun spray tip yet.

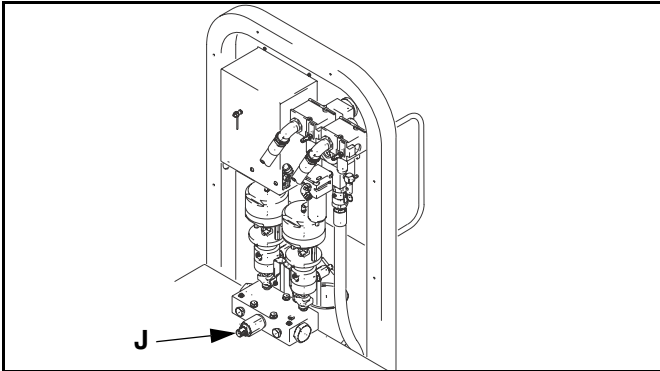

4. Tighten all fittings on unit.
5. Fill pumps A and B packing nuts with throat seal liquid (TSL) and torque to 25-30 ft-lb (34-41 N•m). Follow instructions in pump manual.
6. Fill metering valves A and B packing nuts (H) with throat seal liquid (TSL) and tighten 1/4 turn after nut contacts packings; about 145-155 in/lbs (16-18 N•m). Check packing nut tightness after first hour of operation, again after 24 hours, then check as needed (when TSL discolors or seeps over packing nut). Also check tightness whenever unit is transported.

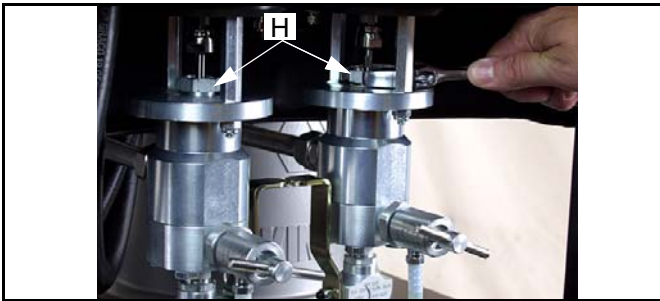

7. Connect air supply line to 3/4 npt(f) air filter inlet (F).



Air supply requirement: 110 psi (0.8 MPa, 8 bar) maximum, 50 psi (0.35 MPa, 3.5 bar) minimum

Flow volume required: 60 scfm minimum; 250 scfm maximum

Model 248842 is designed to use Air Supply Kit 248827.

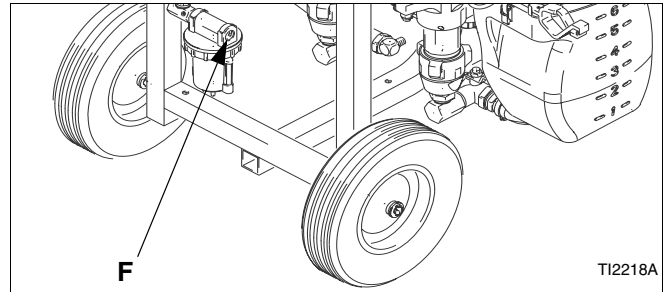

8. Turn off air regulator. Open main air shutoff valve. When starting up, display will show "88888", then software revision, then current ratio.

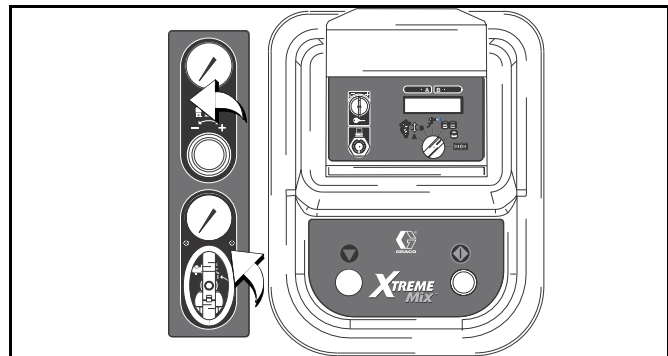

9. Setup ratio.

- a.** Turn knob to spray .
- b.** Current ratio displays.
- c.** Turn key to +, hold for 1 second, then turn back to neutral (vertical) to increase ratio by 0.1. Turning key to + increases ratio by increments of 0.1 until key is turned back to neutral (vice versa when key is turned to -).

To decrease ratio, follow same pattern as increasing, only turn key to -.

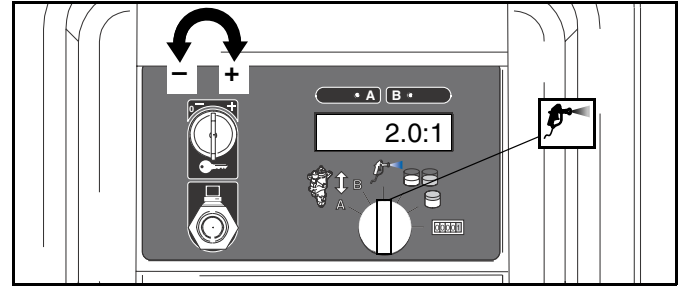

- 10.** Flush and prime system. See pages 14 and 18. Run **Pump Test**, page 20 to check ratio accuracy.

Flushing

There are times when you only want to flush the fluid manifold, such as:

- breaks in spraying
- overnight shutdown
- end of potlife

In this manual, that procedure is referred to as **Fluid Manifold Flushing**. You can flush the fluid manifold by connecting either a:

- solvent pump to the fluid manifold or
- hose and solvent siphon tube to pump A

Other times, you need to flush the entire system:

- first time material is loaded into equipment*
- color change
- servicing
- shutting down equipment for more than 24 hours
- putting equipment into storage

* Some **Full System Flushing** steps are not necessary for initial flushing, as no material has been loaded into the system yet.

To flush the entire system, you first follow the **Fluid Manifold Flushing** procedure, at right, then the **Full System Flushing** procedure, page 16.

WARNING



Read warnings, pages 5-6.

- If your system includes heaters and heated hose, turn them off and allow to cool before flushing. **Do not turn on heaters until fluid lines are clear of solvent.**
- Use the lowest possible pressure when flushing to avoid splashing.
- Before color change or shutdown for storage, flush at a higher flow rate and for a longer time.
- To only flush fluid manifold, see following procedure.
- A circulation setting is available. Consult your distributor. Refer to page 25.

Fluid Manifold Flushing

 **Model 248842 Only:** Follow the flushing procedure in the Remote Manifold manual 310797.

Using Solvent Pump

1. Press Stop  to turn off proportioner. Follow **Pressure Relief Procedure**, page 10. Engage trigger lock. Remove spray tip.

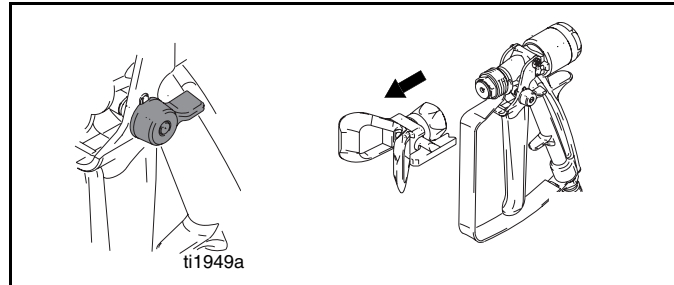

2. Close sampling valves and fluid shutoff valves A and B.

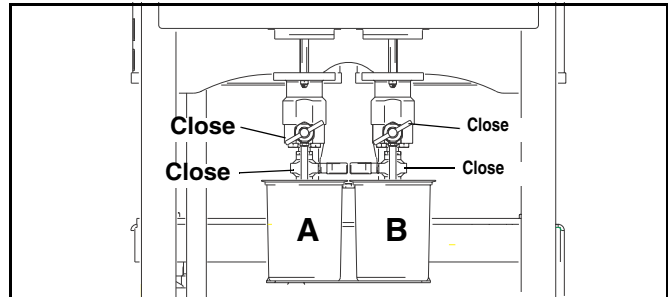

3. Connect a shutoff valve (V) to the fluid manifold inlet on the A side as shown below (valve shown closed). Connect solvent pump line to the shutoff valve. Turn on solvent pump and open solvent shutoff valve.

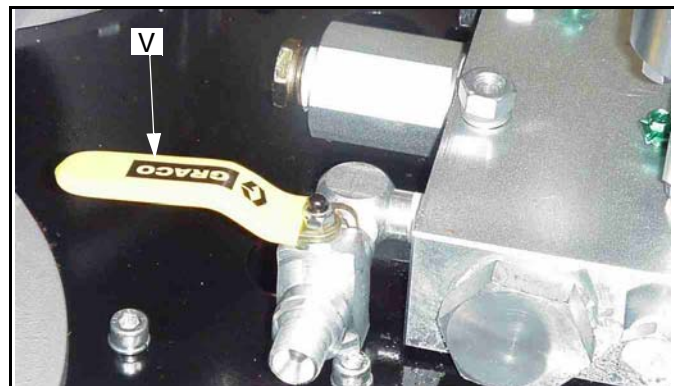

- Adjust regulator to desired pressure; use lowest pressure possible.

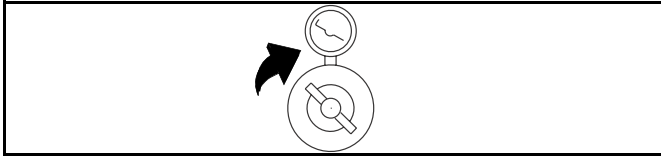

- Disengage trigger lock and trigger gun into a grounded pail. Flush out mixed material until clean solvent dispenses. Engage trigger lock.

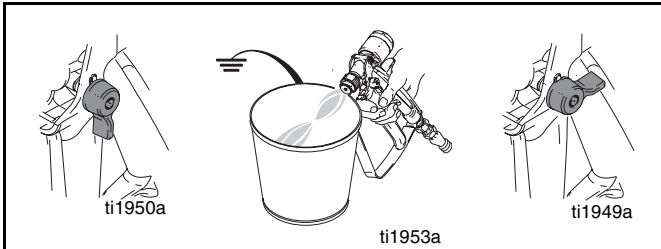

- Shut off solvent pump and close solvent shutoff valve.

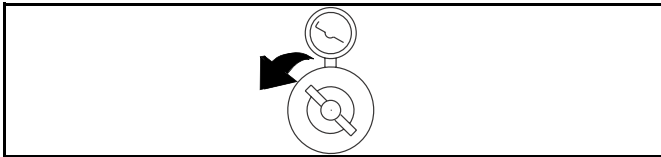

- Follow **Pressure Relief Procedure**, page 10. Engage trigger lock.

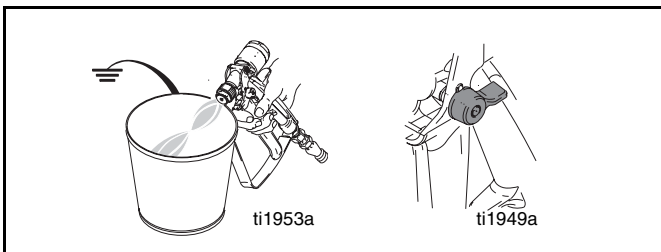

Using Solvent Siphon Tube

- Press Stop  to turn off pumps. Follow **Pressure Relief Procedure**, page 10. Engage trigger lock. Remove spray tip.

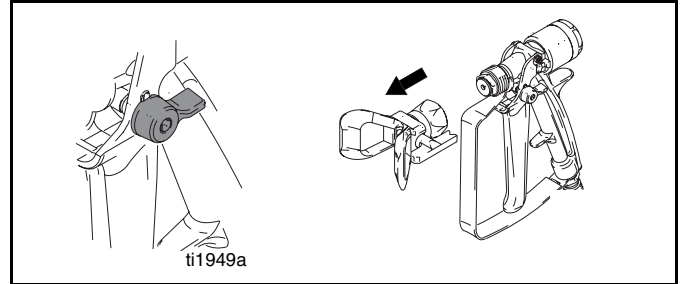

- Connect fluid hose with solvent siphon tube to pump A 3-way ball valve. Put solvent siphon tube into a grounded solvent pail.

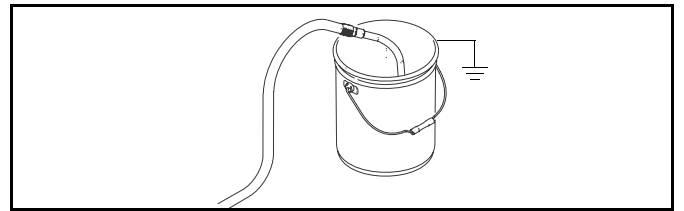

- Turn pump A 3-way ball valve to open suction tube line, as shown below. Arrow on handle shows direction of flow.

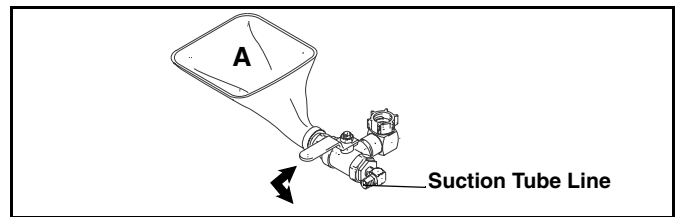

- Open main air shutoff valve. Open shutoff valve A. Close sampling valves A and B.

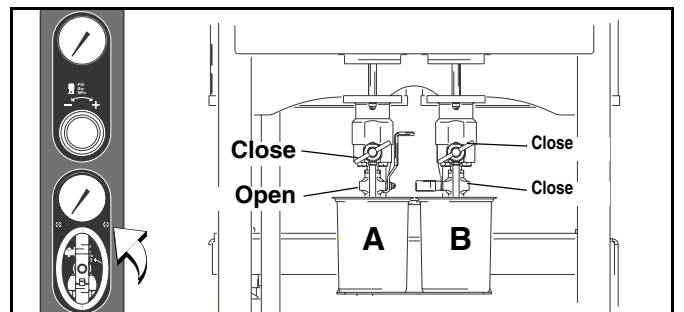

- Turn knob to pump A . Press Start . Slowly turn up air regulator until pump A starts.

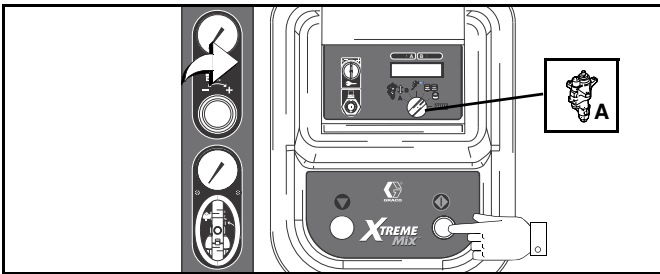

- Disengage trigger lock and trigger gun into a grounded pail until clean solvent dispenses.

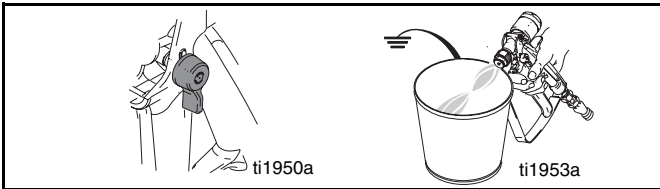

- Engage trigger lock. Press Stop  to turn off proportioner.
- Follow **Pressure Relief Procedure**, page 10.

Full System Flushing

- Follow **Pressure Relief Procedure**, page 10. Engage trigger lock. Turn off air regulator and close main air shutoff valve. Remove spray tip and soak in solvent.

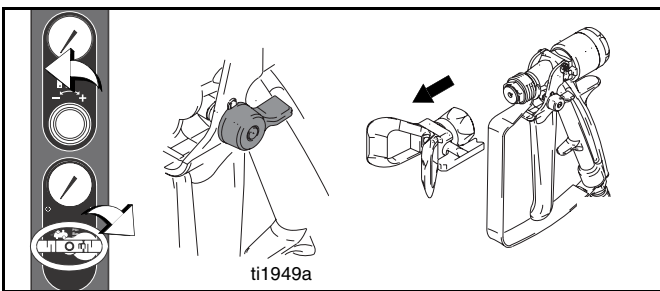



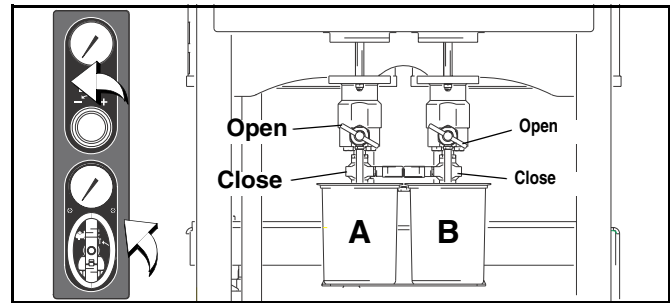



- Place beakers under fluid sampling valves. Open main air shutoff valve. Open fluid sampling valves A and B.

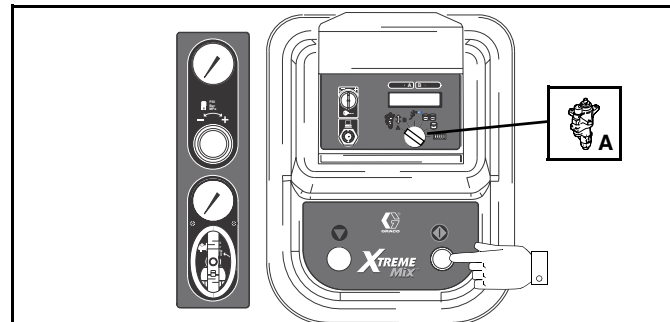



- Turn up air regulator. Pump A and B reservoirs empty, salvaging the material in separate, clean containers.
- Add solvent to A and B reservoirs.
- Close sampling valves. Set air regulator to 50 psi (345 kPa, 3.4 bar).

- Turn knob to pump A . Press Start .





-  When run independently (set to  or ) , the pump runs for 12 cycles, then stops.
- Press Start  and Stop  as needed to clean.
- Open sampling valve A. Pump material through sampling valve A until clean, then press Stop .

-  If the pump does not start when you open the sampling valve, increase the air pressure by 10 psi (69 kPa, 0.7 bar) increments; to avoid splashing, do not exceed 70 psi (483 kPa, 4.8 bar). If the pump still does not start, the solvent may have caused your packings to swell and it is recommended you use Tuff Stack™ Packing Kit 244900.

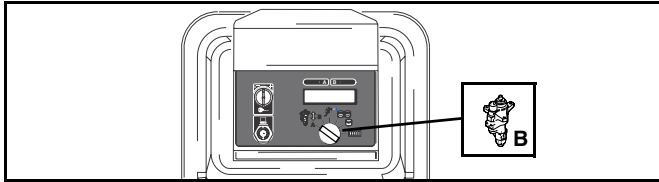
8. Repeat steps 5 and 7, using pump B  setting and sampling valve B, then press Stop .



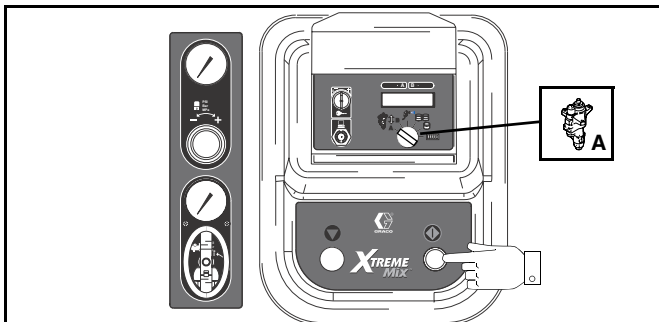

9. Remove fluid filter and soak in solvent. Replace filter cap.
 10. Close sampling valves A and B.

11. Turn knob back to pump A . Press Start .

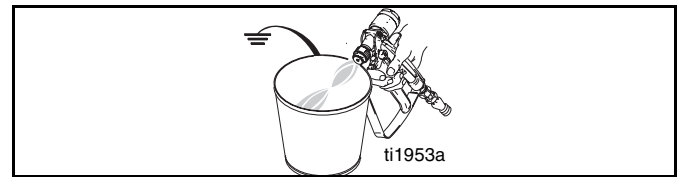

12. Trigger gun into grounded pail. Run pump until clean solvent dispenses, then press Stop .



13. Repeat steps 11 and 12, using pump B  setting, then press Stop .

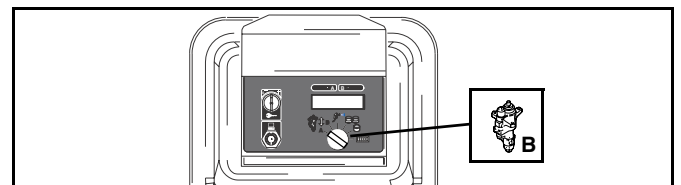

14. Follow **Pressure Relief Procedure**, page 10, and remove gun from hose. See gun manual to further clean gun.

15. Clean hoppers as needed. Empty out solvent.



Some materials require additional cleaning. You may need to recirculate solvent through the system or disassemble the hopper, 3-way valve, and strainer to clean them.

Priming

WARNING



Wear gloves if fluid temperature exceeds 110° F (43° C).

Do not install the gun spray tip yet. Use the lowest possible pressure to prime to avoid splashing.

1. Fill A and B reservoirs (R) with proper materials.

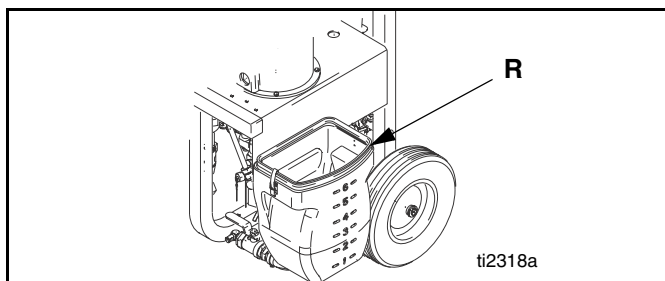

2. Turn both 3-way ball valves to open reservoir lines as shown below. Arrow on handle shows direction of flow.

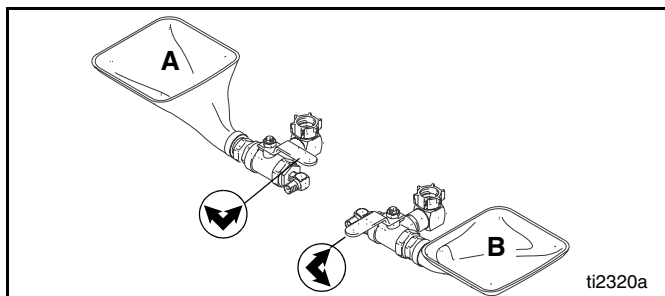



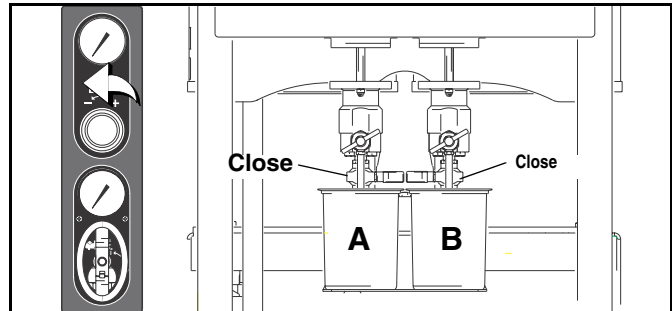

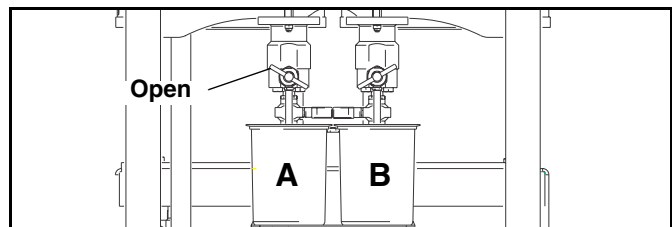

3. Turn off air regulator. Close fluid shutoff valves A and B.



4. Place a container under each sampling valve. Open sampling valve A slowly.



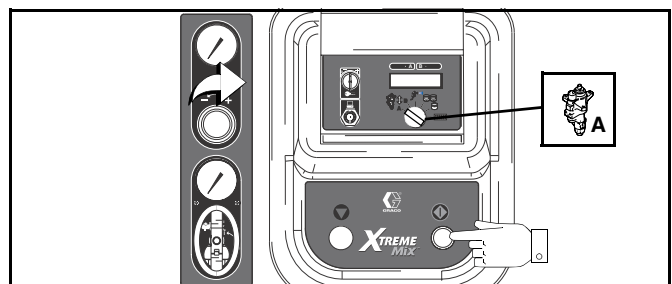

When run independently (set to  or ) , the pump runs for 12 cycles, then stops. Press Start  and Stop  as needed to prime. Monitor containers to avoid overflowing.

5. Turn knob to pump A . Press Start . Turn up air regulator slowly until pump A starts.

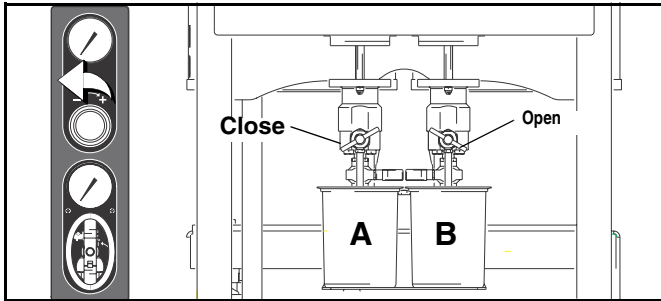

6. When side A is primed, turn off air regulator. Close sampling valve A. Open sampling valve B slowly.



7. Turn knob to pump B . Press Start . Turn up air regulator slowly until pump B starts.

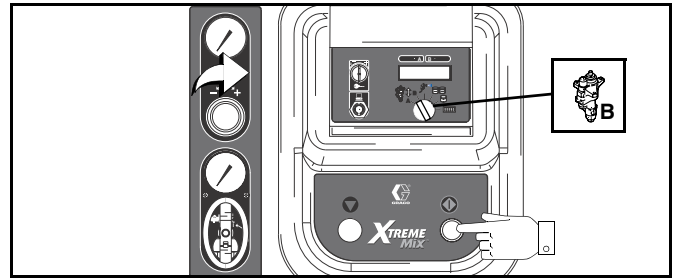

8. When side B is primed, Stop  and close sampling valve B.

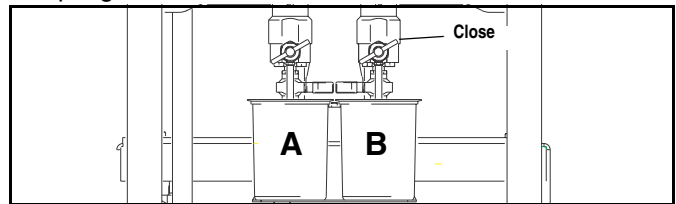



Pump Test

Follow this procedure the first time system is operated (after flushing and priming) and whenever you need to check whether pumps are on ratio.

The following table shows the volume dispensed during the pump test, based on pump ratio. Dispense into a container with adequate graduations.

Pump	Volume Dispensed
45:1	750 cc
56:1	660 cc
68:1	540 cc
80:1	435 cc

 For accurate ratios, pump lowers must be same size on both sides.

1. Turn knob to pump test . Turn off air regulator. Open main air shutoff valve. Adjust air pressure to 50 psi (0.35 MPa, 3.5 bar).

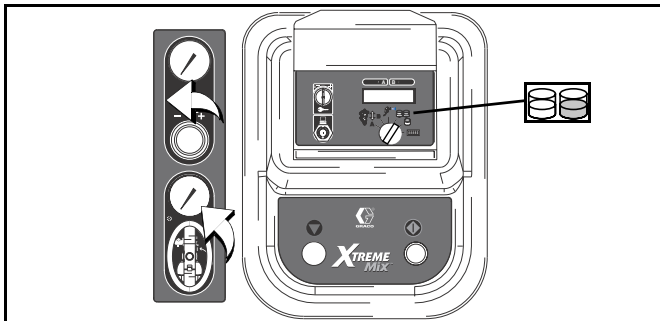

2. Dispense fluid A:
 - a. Close fluid shutoff valves and sampling valves A and B.
 - b. Place a clean 1 quart (1000 cc) container under sampling valve A.

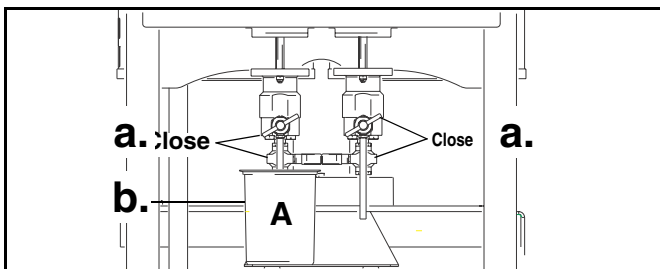

- c. Press Start . Pump A light comes on.
- d. Slowly open and adjust sampling valve A to achieve desired flow. The pump stops automatically when dispense is complete. Pump A light turns off, Pump B light comes on.

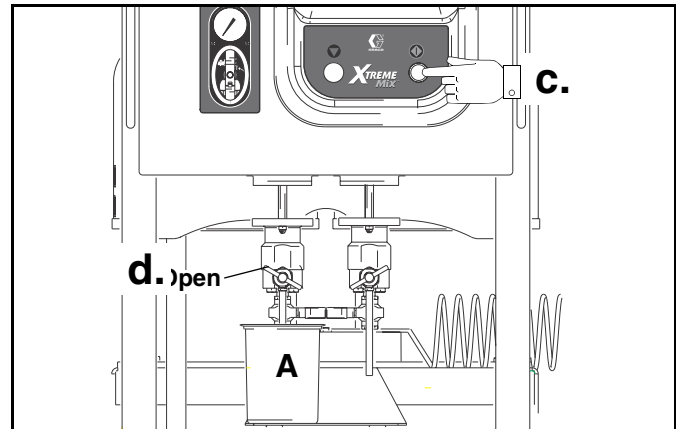

3. Close sampling valve A.

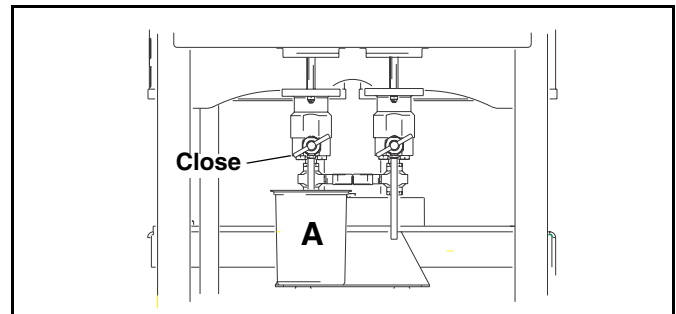

4. Dispense fluid B as follows:

- a. Place a clean 1 quart (1000 cc) container under sampling valve B.
- b. Slowly open and adjust sampling valve B to achieve desired flow. The pump stops automatically when dispense is complete. Pump B light turns off.

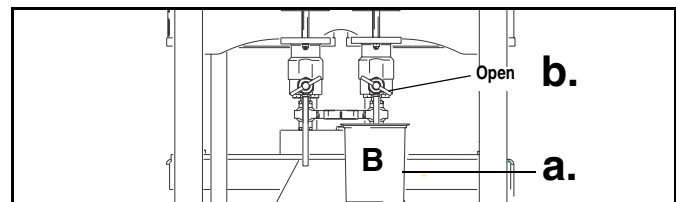

5. Close sampling valve B.

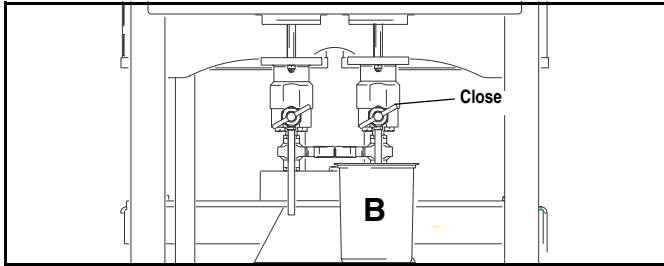

6. Compare fluid amounts in the containers; they should be equal. Repeat test if fluids are not equal. If problem persists, see Troubleshooting in Xtreme Mix Repair Manual.

Spraying

WARNING



Wear gloves if fluid temperature exceeds 110° F (43° C).

1. If heaters are used, turn them on. Operate heaters as instructed in their manuals.
2. Close sampling valves A and B. Open shutoff valves A and B.

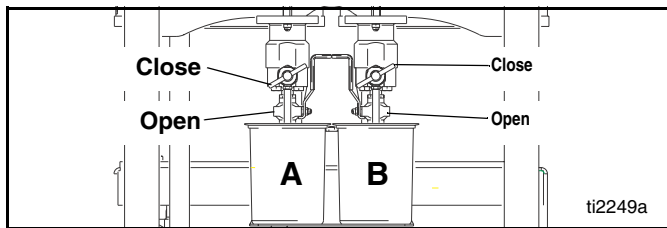

3. Turn knob to spray . Press Start .

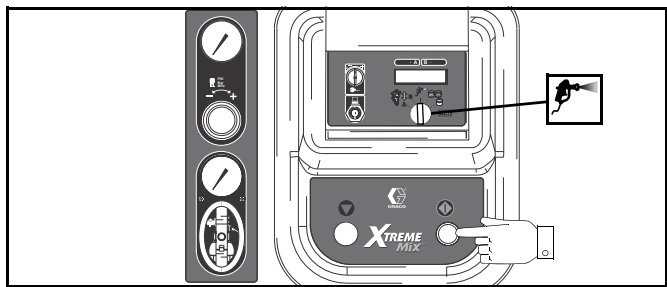

4. Trigger gun into a pail and slowly increase air regulator pressure until pump is running and clean material is dispensed.

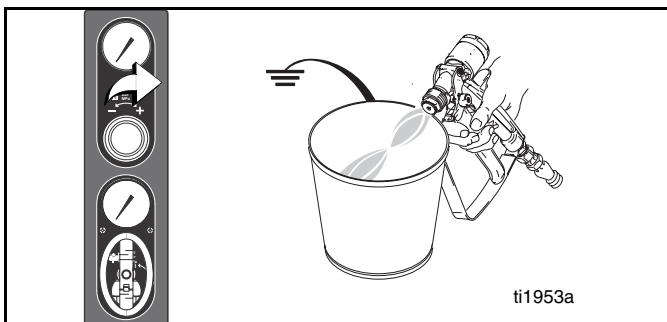

5. Engage trigger lock. Press Stop .

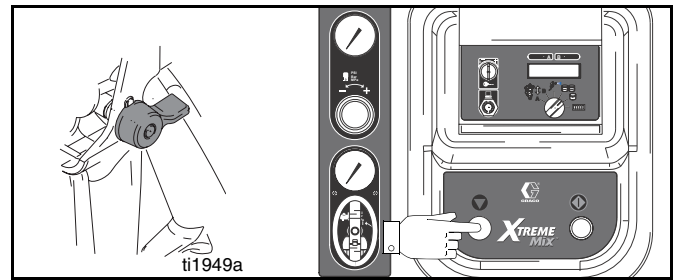

6. Follow **Pressure Relief Procedure**, page 10.

7. Engage trigger lock. Install tip on gun.

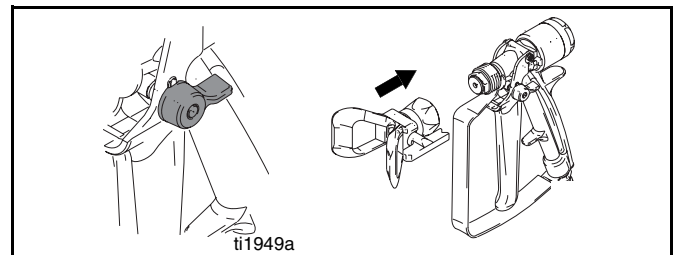

8. Adjust air regulator to the necessary spraying pressure and apply the coating. Refer to **Mix and Integration Tests**, page 23.

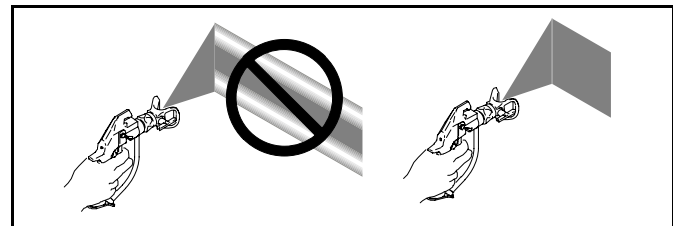

9. Follow **Fluid Manifold Flushing**, page 14, or **Shutdown**, page 25, when you are done spraying or before potlife expires.

 Mixed material potlife or working time decreases with increased temperature.

Mix and Integration Tests

Use the following tests to check for proper mix and integration.

Butterfly Test

WARNING



Follow **Pressure Relief Procedure**, page 10, before removing spray tip. Read warnings, page 5.

At low pressure, normal flow rate, and without a spray tip installed, dispense a 1/2" (12.7 mm) bead of material onto foil until multiple changeovers of each pump have occurred. Place a second sheet of foil over the first then peel it back and look for unmixed material (appears marble-like).

Curing Test

Spray a single continuous pattern on foil at typical pressure setting, flow rate, and tip size until multiple changeovers of each pump have occurred. Trigger and de-trigger at typical intervals for the application. Do not overlap or cross over your spray pattern.

Check curing at various time intervals, listed on the material data sheet. For example, check for dry to touch by running your finger along the test pattern's entire length at the time listed on the data sheet.

Appearance Test

Spray material onto metal substrate. Look for variations in color, gloss, or texture that may indicate improperly catalyzed material.

Batch Dispense or Ratio Check

 Batch dispense is always 1 liter of total volume, regardless of ratio setting.

Follow this procedure to dispense a batch (into one container) or verify a ratio setting (use separate container for fluid A and B). Dispense into a container with graduations no greater than 5% of each component.

1. Turn knob to batch dispense . Turn off air regulator. Open main air shutoff valve. Adjust air pressure to 50 psi (0.35 MPa, 3.5 bar).

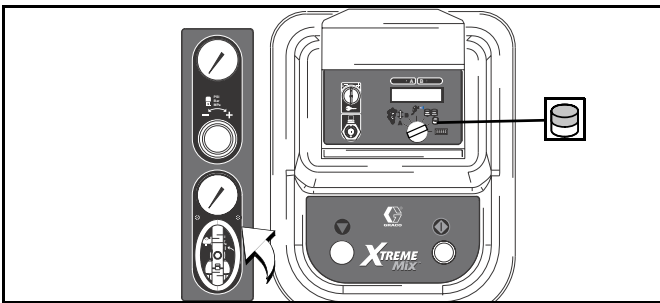

2. Dispense fluid A:
 - a. Close fluid shutoff valves and sampling valves A and B.
 - b. Place a clean 1 quart (1000 cc) container under sampling valve A.

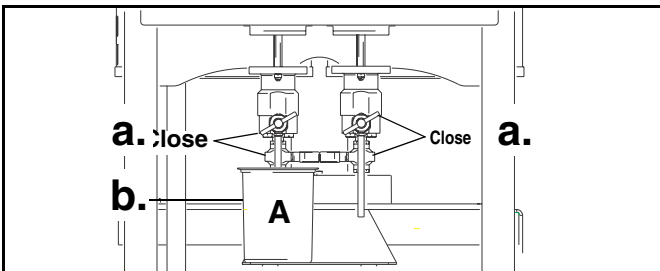

- c. Press Start . Pump A light comes on.

- d. Slowly open and adjust sampling valve A to achieve desired flow. The pump stops automatically when dispense is complete. Pump A light turns off, Pump B light comes on.

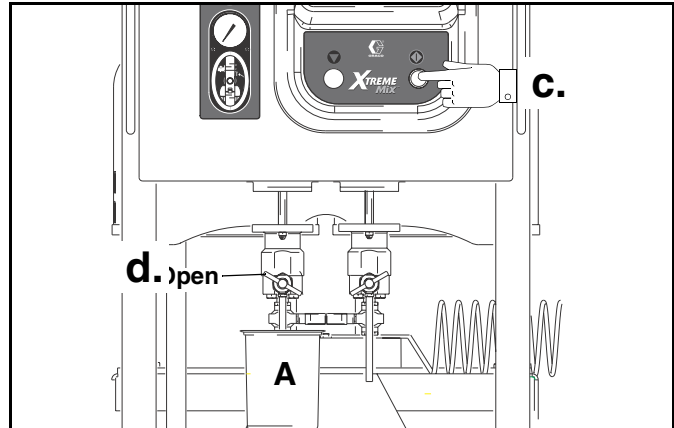

3. Close sampling valve A.

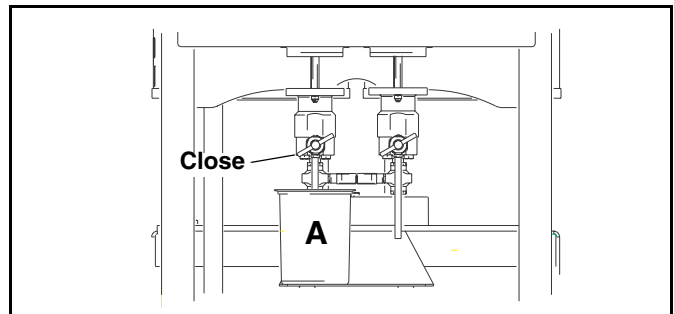

4. Dispense fluid B as follows:
 - a. *Batch dispense:* move the 1 quart (1000 cc) container under sampling valve B.
 - Ratio check:* place clean 1 quart (1000 cc) container under sampling valve B.
 - b. Slowly open and adjust sampling valve B to achieve desired flow. The pump stops automatically when dispense is complete. Pump B light turns off.

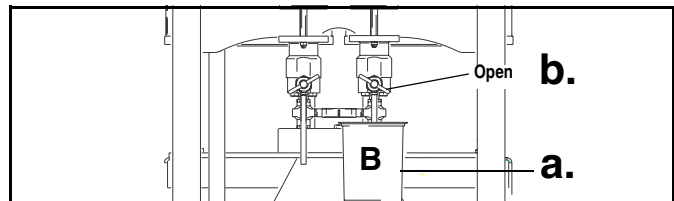

5. *Batch dispense:* stir material until mixed.

Ratio check: compare A and B fluid dispense.

Pump Cycle Counter

To display total A and B pump cycles since the last reset, turn knob to cycle counter .

To reset the cycle counter to 0, turn the key to – (or 0) while knob is set to cycle counter .

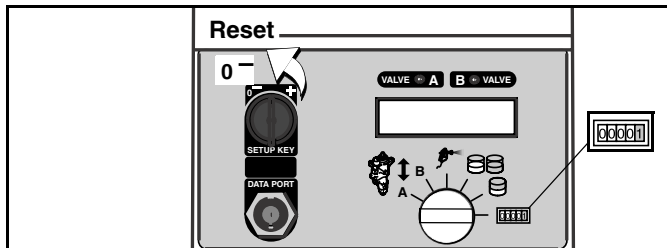

Circulation Setting

Fluid can be circulated up to the mix manifold. You can only circulate one fluid component at a time. Additional fluid hardware is required; consult your distributor.

To set the Xtreme Mix to circulate:

1. Decrease the pump air pressure supply to the minimum required to maintain the desired circulation volume.
2. Turn knob to spray .
3. To circulate fluid A, set ratio to 1.0:0, which is the lowest ratio setting

To circulate fluid B, set ratio to 0.0:1, which is the second lowest ratio setting

See page 13 for instructions on setting ratio.

4. Press Start .

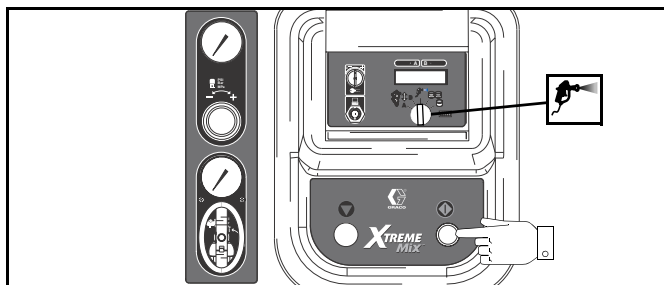

5. Depending on the ratio selected, the following will occur:

- **1.0:1** - Air motor pilot valve A and metering valve A open to run pump A.
- **0.0:1** - Air motor pilot valve B and metering valve B open to run pump B.

To terminate circulation, press Stop .

To begin circulating again, press Start .

To begin spraying, reset to desired ratio and adjust pump to spray pressure.

Shutdown

Follow this procedure before prolonged shutdown or servicing equipment.

1. Follow **Pressure Relief Procedure**, page 10. Engage trigger lock, turn off air regulator, and close main air shutoff valve. Remove spray tip.

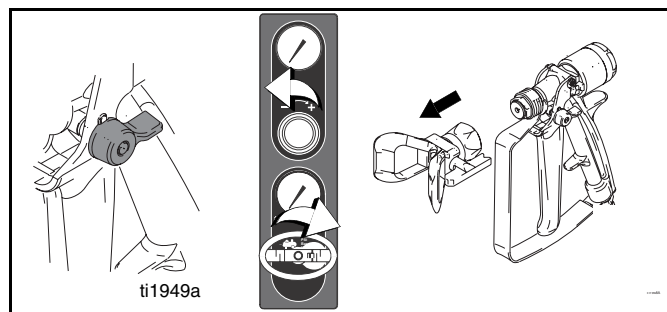

2. Follow **Flushing**, page 14.
3. Follow **Pressure Relief Procedure**, page 10. Engage trigger lock.
4. Before prolonged shutdown: cap fluid outlets to keep solvent in the lines. Fill pump A and B packing nuts with throat seal liquid (TSL); follow instructions in pump manual.

Alarms

* Indicates error where audible alarm sounds once briefly.

** Indicates error where audible alarm sound pulses.



- An alarm condition will shutdown equipment.
- A chirping sound every 60 seconds indicates the unit is set for circulation (page 25).
- See Xtreme Mix Repair manual for troubleshooting and repair.

Code	Alarm	Active	Problem	Cause
<i>Startup Errors</i>				
01	Sensor Error A*	Always	No signal from pump A sensor	Loose cable, failed sensor or cable
02	Sensor Error B*	Always	No signal from pump B sensor	Loose cable, failed sensor or cable
03	Controller Error*	Always	Loss of communication between main and display boards	Loose cable, failed board
<i>Operating Errors</i>				
04	Pump Runaway A**	Spray Test Batch	 This alarm is not active when pumps are run independently.	Empty fluid reservoir(s) Clogged fluid filter Hose rupture after mix manifold Sampling valve open too far Excessive cavitation
05	Pump Runaway B**			
06	Pump Error A**	Spray Test Batch	Pump does not stall after top change over Pump cavitating excessively	Foot valve leak Air in lines caused by loose fitting or use of agitator Empty fluid reservoir(s)
07	Pump Error B**			
08	Sensor Code Error	Always	Software boot, sensor values reverted to default	Sensor value data corrupt; board needs replacement and /or recalibration
09	Metering Error A**	Spray	A dose too great	Metering valve A leak Empty B fluid reservoir
10	Metering Error B**	Spray	B dose too great	Metering valve B leak Empty A fluid reservoir
11	Sensor Reading Low A*	Always	Pump stroke travels beyond sensor range at bottom change over	Sensor or bracket loose
12	Sensor Reading Low B*			Sensor magnet dirty
13	Sensor Reading High A*	Always	Pump stroke travels beyond sensor range at top change over	Sensor or bracket loose
14	Sensor Reading High B*			Sensor magnet dirty
<i>Testing Error</i>				
15	Piston packing/ball A*	Test	Pump does not completely stall in up stroke	Piston packing or ball check failure
16	Piston packing/ball B*			
17	Inlet Ball A*	Test	Pump does not completely stall in down-stroke	Foot valve ball check failure
18	Inlet Ball B*			
19	Metering Valve A*	Test	Pump does not completely stall in both up and down strokes	Throat packing or metering valve failure
20	Metering Valve B*			

Performance Charts

45:1 King Pump

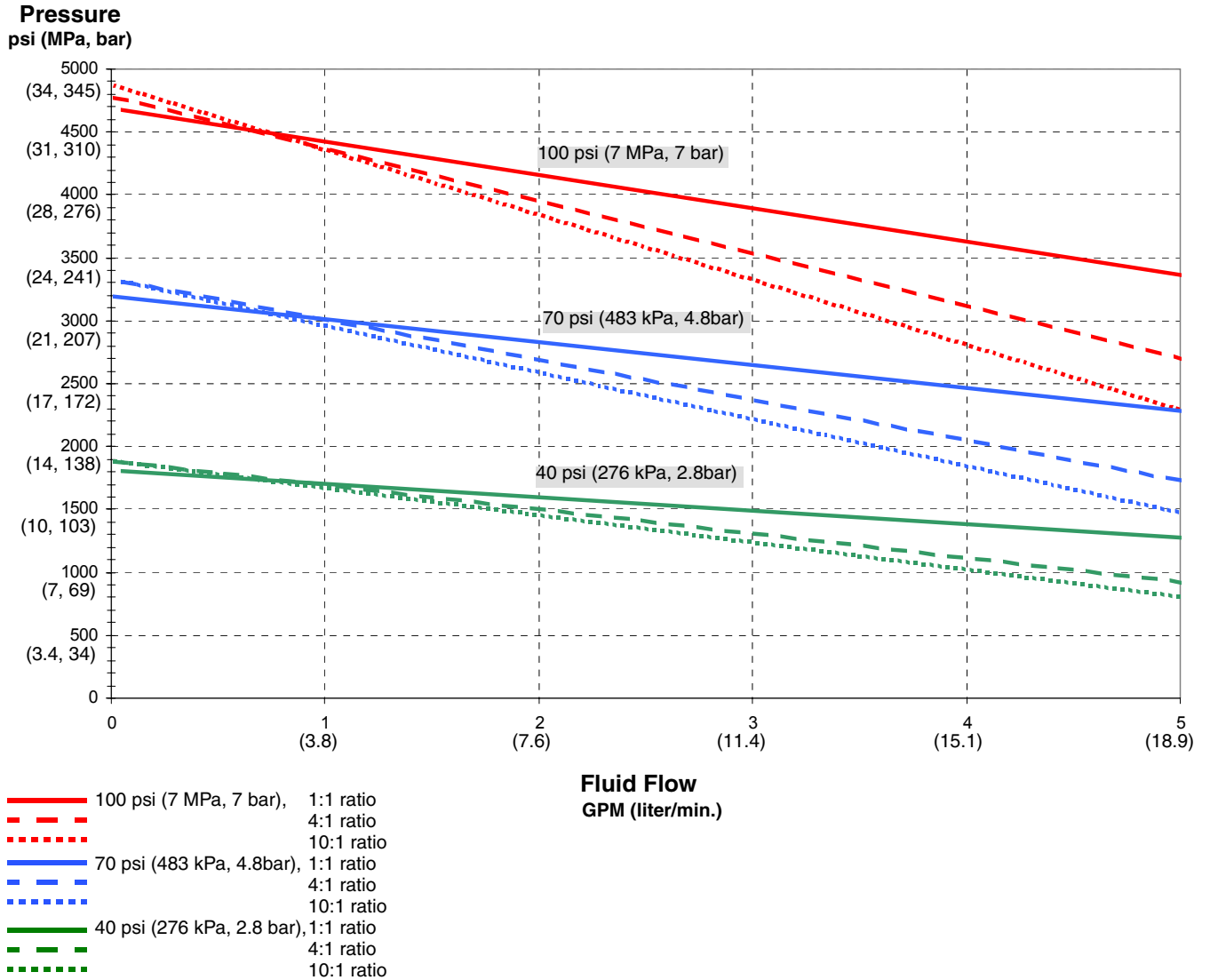

56:1 King Pump

Pressure
psi (MPa, bar)

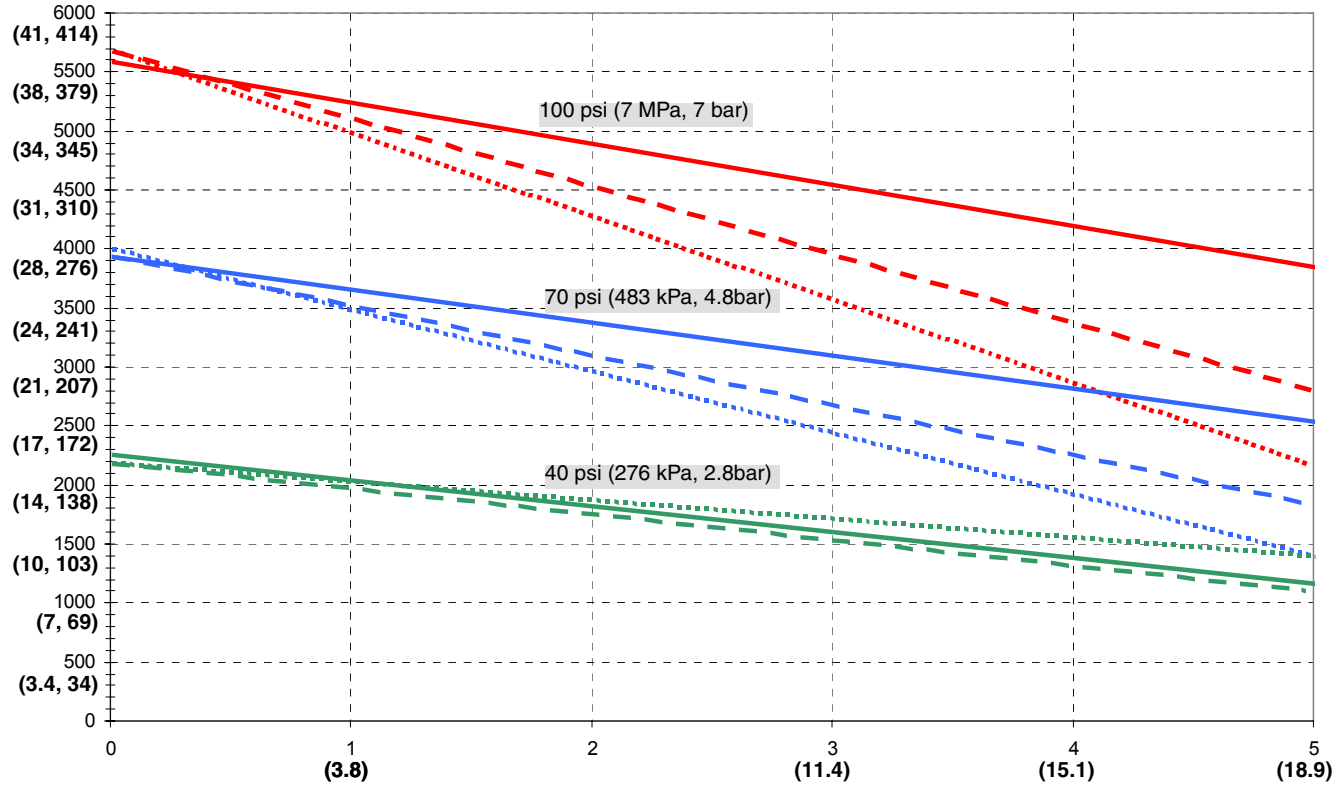

- 100 psi (7 MPa, 7 bar), 1:1 ratio
- - - 100 psi (7 MPa, 7 bar), 4:1 ratio
- ... 100 psi (7 MPa, 7 bar), 10:1 ratio
- 70 psi (483 kPa, 4.8 bar), 1:1 ratio
- - - 70 psi (483 kPa, 4.8 bar), 4:1 ratio
- ... 70 psi (483 kPa, 4.8 bar), 10:1 ratio
- 40 psi (276 kPa, 2.8 bar), 1:1 ratio
- - - 40 psi (276 kPa, 2.8 bar), 4:1 ratio
- ... 40 psi (276 kPa, 2.8 bar), 10:1 ratio

Fluid Flow
GPM (liter/min.)

68:1 King Pump

Pressure
psi (MPa, bar)

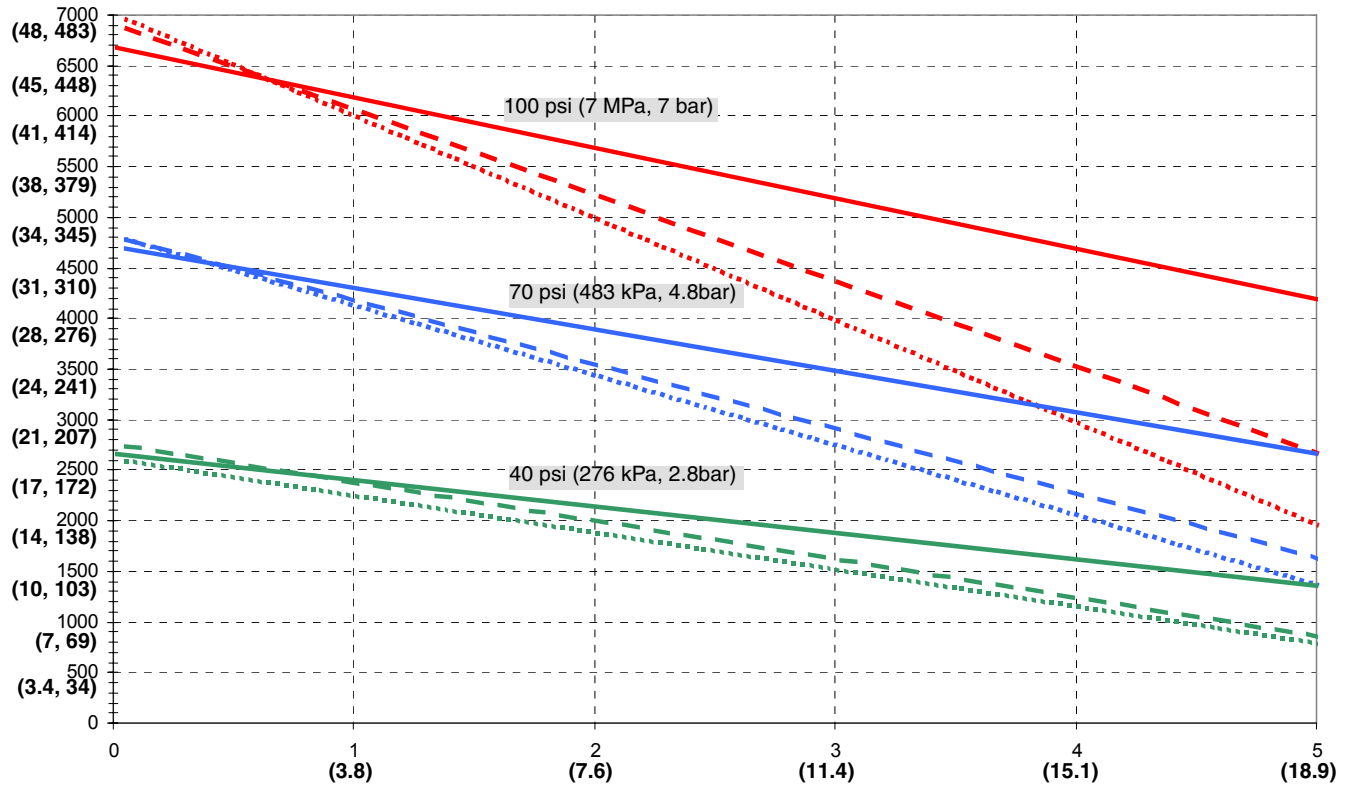

- 100 psi (7 MPa, 7 bar), 1:1 ratio
- - - 100 psi (7 MPa, 7 bar), 4:1 ratio
- ... 100 psi (7 MPa, 7 bar), 10:1 ratio
- 70 psi (483 kPa, 4.8bar), 1:1 ratio
- - - 70 psi (483 kPa, 4.8bar), 4:1 ratio
- ... 70 psi (483 kPa, 4.8bar), 10:1 ratio
- 40 psi (276 kPa, 2.8 bar), 1:1 ratio
- - - 40 psi (276 kPa, 2.8 bar), 4:1 ratio
- ... 40 psi (276 kPa, 2.8 bar), 10:1 ratio

Fluid Flow
GPM (liter/min.)

80:1 King Pump

Pressure
psi (MPa, bar)

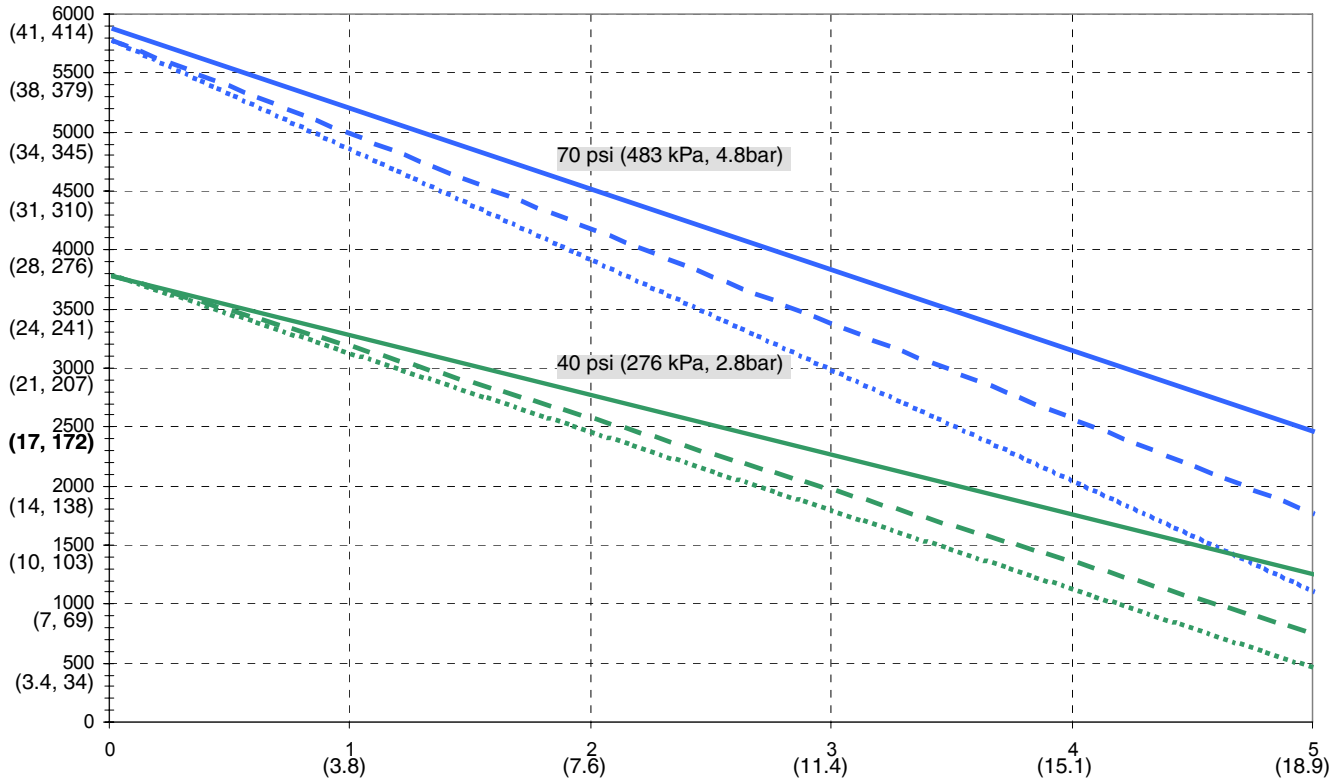

- 70 psi (483 kPa, 4.8bar), 1:1 ratio
- - - 70 psi (483 kPa, 4.8bar), 4:1 ratio
- ... 70 psi (483 kPa, 4.8bar), 10:1 ratio
- 40 psi (276 kPa, 2.8 bar), 1:1 ratio
- - - 40 psi (276 kPa, 2.8 bar), 4:1 ratio
- ... 40 psi (276 kPa, 2.8 bar), 10:1 ratio

Fluid Flow
GPM (liter/min.)

Technical Data

Mix ratio range	0.0:1-10:1 (in 0.1 increments)
Ratio tolerance range	+/- 5%
Flow rates	
Minimum	1 qt./min. (0.95 liter/min.)*
Maximum	3 gal./min. (11.4 liter/min.)
Fluid viscosity range	200-20,000 cps (heavier viscosities can be mixed with use of optional heaters, heated hoses, and hardware)
Fluid filtration	60 mesh, (238 micron) standard on pump outlets (filter assembly not included on models 248831, 248832, 248833, and 248834)
Air inlet	
Model 248842	3/4 npt(m)
All Other Models	3/4 npt(f)
Model 248842 Fluid inlet	3/4 npsm union in 1" npt(f) ball valve
Maximum fluid working pressure	
45:1	4500 psi (31 MPa, 310 bar)
56:1	5600 psi (38.6 MPa, 386 bar)
68:1	6800 psi (46.9 MPa, 469 bar)
68:1 Model 248842 only	5000 psi (34.5 MPa, 345 bar)
80:1	7250 psi (50 MPa, 500 bar)
Air supply pressure range	50-110 psi (345-800 kPa, 3.5-8 bar)
Model 248842: Maximum fluid feed pressure	500 psi (3.5 MPa, 35 bar)
Maximum air consumption at 100 psi (0.7 MPa, 7 bar) in cfm (m ³ /min.)	
45:1	110 (3.1)
56:1	125 (3.5)
68:1	155 (4.4)
80:1	180 (5.1)
Ambient temperature range	
Operating	32-130° F (0-54° C)
Storage	30-160° F (-1-71° C)
Environmental Conditions Rating	Indoor/outdoor use Altitude up to 4000 meters Maximum relative humidity to 99% up to 54° C Pollution degree (11) Installation category (2)
Sound pressure	98 dBA at 100 psi (0.7 MPa, 7 bar)
Wetted parts	
Suction tubes (if used)	aluminum
Pumps	carbon steel, alloy steel, 303, 440 & 17-4ph grades stainless steel, zinc and nickel plating, ductile iron, tungsten carbide, PTFE, leather
Metering Valves	carbon steel, zinc plating, carbide, polyethylene, leather
Manifold	carbon steel, zinc plating, carbide, 302 stainless steel
Mixer	stainless steel
Spray gun	See gun manual
PC Communications	RS-232
Dimensions	
Cart model (width x height x diameter)	33" wide x 64.53" high x 44.5" deep (83.8 x 163.9 x 113 cm)
Weight (cart, without hose and gun)	625 lbs. (285 kg)

* Minimum flow rate is dependent on the material being sprayed and mixing capability. Test your material for specific flow rate.

Graco Standard Warranty

Graco warrants all equipment referenced in this document which is manufactured by Graco and bearing its name to be free from defects in material and workmanship on the date of sale to the original purchaser for use. With the exception of any special, extended, or limited warranty published by Graco, Graco will, for a period of twelve months from the date of sale, repair or replace any part of the equipment determined by Graco to be defective. This warranty applies only when the equipment is installed, operated and maintained in accordance with Graco's written recommendations.

This warranty does not cover, and Graco shall not be liable for general wear and tear, or any malfunction, damage or wear caused by faulty installation, misapplication, abrasion, corrosion, inadequate or improper maintenance, negligence, accident, tampering, or substitution of non-Graco component parts. Nor shall Graco be liable for malfunction, damage or wear caused by the incompatibility of Graco equipment with structures, accessories, equipment or materials not supplied by Graco, or the improper design, manufacture, installation, operation or maintenance of structures, accessories, equipment or materials not supplied by Graco.

This warranty is conditioned upon the prepaid return of the equipment claimed to be defective to an authorized Graco distributor for verification of the claimed defect. If the claimed defect is verified, Graco will repair or replace free of charge any defective parts. The equipment will be returned to the original purchaser transportation prepaid. If inspection of the equipment does not disclose any defect in material or workmanship, repairs will be made at a reasonable charge, which charges may include the costs of parts, labor, and transportation.

THIS WARRANTY IS EXCLUSIVE, AND IS IN LIEU OF ANY OTHER WARRANTIES, EXPRESS OR IMPLIED, INCLUDING BUT NOT LIMITED TO WARRANTY OF MERCHANTABILITY OR WARRANTY OF FITNESS FOR A PARTICULAR PURPOSE.

Graco's sole obligation and buyer's sole remedy for any breach of warranty shall be as set forth above. The buyer agrees that no other remedy (including, but not limited to, incidental or consequential damages for lost profits, lost sales, injury to person or property, or any other incidental or consequential loss) shall be available. Any action for breach of warranty must be brought within two (2) years of the date of sale.

GRACO MAKES NO WARRANTY, AND DISCLAIMS ALL IMPLIED WARRANTIES OF MERCHANTABILITY AND FITNESS FOR A PARTICULAR PURPOSE, IN CONNECTION WITH ACCESSORIES, EQUIPMENT, MATERIALS OR COMPONENTS SOLD BUT NOT MANUFACTURED BY GRACO. These items sold, but not manufactured by Graco (such as electric motors, switches, hose, etc.), are subject to the warranty, if any, of their manufacturer. Graco will provide purchaser with reasonable assistance in making any claim for breach of these warranties.

In no event will Graco be liable for indirect, incidental, special or consequential damages resulting from Graco supplying equipment hereunder, or the furnishing, performance, or use of any products or other goods sold hereto, whether due to a breach of contract, breach of warranty, the negligence of Graco, or otherwise.

FOR GRACO CANADA CUSTOMERS

The Parties acknowledge that they have required that the present document, as well as all documents, notices and legal proceedings entered into, given or instituted pursuant hereto or relating directly or indirectly hereto, be drawn up in English. Les parties reconnaissent avoir convenu que la rédaction du présente document sera en Anglais, ainsi que tous documents, avis et procédures judiciaires exécutés, donnés ou intentés, à la suite de ou en rapport, directement ou indirectement, avec les procédures concernées.

Graco Information

TO PLACE AN ORDER, contact your Graco distributor or call to identify the nearest distributor.

Phone: 612-623-6921 **or Toll Free:** 1-800-328-0211, **Fax:** 612-378-3505

*All written and visual data contained in this document reflects the latest product information available at the time of publication.
Graco reserves the right to make changes at any time without notice.*

Original Instructions. This manual contains English. MM 309535

Graco Headquarters: Minneapolis

International Offices: Belgium, China, Japan, Korea

GRACO INC. P.O. BOX 1441 MINNEAPOLIS, MN 55440-1441

Copyright 2002, Graco Inc. is registered to ISO 9001

www.graco.com

Revised 01/2011