

## Edition 1

---

This publication could contain technical inaccuracies or typographical errors. Changes are made periodically to the information herein, these changes will be made in later editions. IBM may make improvements and/or changes in the product(s) and/or programs(s) at any time.

It is possible that this publication may contain reference to, or information about, IBM products (machines and programs), programming, or services that are not announced in your country.



Requests for copies of this publication and for technical information about IBM products should be made to your IBM Authorized Dealer or IBM Retailer.

No part of this publication may be reproduced or distributed in any form or by any means without prior permission in writing from the International Business Machines Corporation.

References in this publication to IBM products, programs, or services do not imply that IBM intends to make these available in all countries in which IBM operates. Any reference to an IBM product, program or service is not intended to state or imply that only IBM's product, program, or service may be used. Any functionally equivalent product, program, or service that does not infringe any of IBM's intellectual property rights or other legally protectable rights may be used instead of the IBM product, program, or service. Evaluation and verification of operation in conjunction with other products, programs, or services, except those expressly designated by IBM, are the user's responsibility.

IBM may have patents or pending patent applications covering subject matter in this document. The furnishing of this document does not give you any license to these patents

### Trademarks

The following terms, used in this publication, are trademarks or service marks of the IBM Corporation in the United States or other countries:

**ENERGY STAR is a U.S. registered mark.**

© Copyright International Business Machines Corporation 1999

All rights reserved.

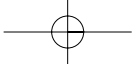

## **Packing List**

---

**The product package should include the following items:**

1. Monitor
2. Owner's Manual
3. Power Cord
4. Swivel Base
5. Diskette

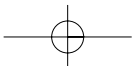
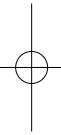
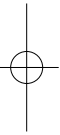

## Table of Contents

---

<b>Introduction</b>	
Features.....	A1
<b>Precautions</b>	
Workplace preparation.....	A2
Working Practices.....	A3
<b>Tilt/Swivel Base</b>	
Installation.....	A5
<b>Connecting the Monitor</b> .....	A6
<b>Location and Function of Controls</b>	
Front View .....	A7
Rear View .....	A7
<b>Control Panel Function</b>	
Front Panel Controls.....	A8
OSD Button.....	A8
△▽/◀▶ Buttons.....	A8
SET Button.....	A8
Power Button .....	A8
Power Indicator.....	A8
<b>On Screen Display (OSD) Control Adjustment</b> .....	A9
<b>On Screen Display (OSD) Selection and Adjustment</b> .....	A10
<b>Video Memory Modes</b>	
Display Modes(Resolution) .....	A13
User Modes.....	A13
Recalling Display Modes.....	A13
<b>Energy Saving Design</b>	
Power Consumption.....	A14
<b>MPR II, Self Diagnostics and DDC</b>	
Low Radiation Compliance (MPR II).....	A15
Self Diagnostics .....	A15
DDC (Display Data Channel).....	A15
<b>Troubleshooting</b> .....	A16
<b>Further help</b> .....	A17
<b>Service</b> .....	A18
<b>Specifications</b> .....	A19
<b>Compliances</b> .....	A21
<b>Warranty</b> .....	See back of manual

## Introduction

---

Thank you for purchasing a high resolution monitor. It will give you high resolution performance and convenient reliable operation in a variety of video operating modes.

### Features

- The monitor is a 15 inches (13.8 inches viewable ) intelligent, microprocessor based monitor compatible with most analog RGB (Red, Green, Blue) display standards, including IBM PC<sup>®</sup>, PS/2<sup>®</sup>, Apple<sup>®</sup>, Macintosh<sup>®</sup>, Centris<sup>®</sup>, Quadra<sup>®</sup>, and Macintosh II family.
- The monitor provides crisp text and vivid color graphics with VGA, SVGA, XGA, and VESA Ergonomic modes (non-interlaced), and most Macintosh compatible color video cards when used with the appropriate adaptor. The monitor's wide compatibility makes it possible to upgrade video cards or software without purchasing a new monitor.
- Digitally controlled auto-scanning is done with the microprocessor for horizontal scan frequencies between 30 and 70kHz, and vertical scan frequencies between 50-160Hz. The microprocessor-based intelligence allows the monitor to operate in each frequency mode with the precision of a fixed frequency monitor.
- The microprocessor-based digital controls allow you to adjust conveniently a variety of image controls by using the OSD (On Screen Display).
- This monitor is capable of producing a maximum horizontal resolution of 1024 dots and a maximum vertical resolution of 768 lines. It is well suited for CAD work and sophisticated windowing environments.
- For low cost of monitor operation, this monitor is certified as meeting the EPA Energy Star requirements, and utilizes the VESA Display Power Management Signalling (DPMS) protocol for power saving during non-use periods.

## Precautions

---



### To avoid shock hazard:

- Do not remove the covers.
- Do not operate this product unless the stand is attached.
- Do not connect or disconnect this product during an electrical storm.
- The power cord plug must be connected to a properly wired and grounded power outlet.
- Any equipment to which this product will be attached must also be connected to properly wired and grounded power outlets.
- To isolate the monitor from the electrical supply, you must remove the plug from the power outlet. The power outlet should be easily accessible.

### Handling:

- Your color monitor is heavy, so handle it with care.

## Workplace preparation

### Positioning the Monitor

Choose a suitable place to position the monitor where it is not near fluorescent desk lighting or any equipment that produces magnetic fields that could cause interference. Ensure that the furniture or equipment can support the weight of the monitor. Allow at least 2 inches (50mm) ventilation space around the monitor.

### Height

The monitor should be positioned so that the top of the screen is slightly below your eye level when you sit at your workstation.

### Orientation

Choose a position that gives the least reflection from lights and windows, usually at a right angle to any windows. The monitor should be positioned directly in front of you so that you do not have to twist your body. Tilt the monitor to a comfortable viewing angle.

---

## **Working Practices**

### **Rest**

Take regular breaks. Vary your posture, and stand up and stretch occasionally as prolonged use of computer workstations can be tiring.

### **Back**

You should sit back in the chair and use the back rest.

### **Hands**

Use a light touch on the keyboard, keeping your hands and fingers relaxed. Allow a space in front of the keyboard to rest your wrists when not typing. Consider using a wristpad.

### **Eyesight**

Working with monitors, in common with any prolonged close work, can be visually demanding. Look away from the screen periodically and have your eyesight checked regularly.

### **Screen settings**

Set the screen brightness and contrast to a comfortable level. You may have to adjust this as the lighting changes during the day. Many application programs let you select color combinations which can help you to view in comfort.

---

**Power Source:**

1. Make sure the power cord is the correct type that required in your area.
2. This monitor has a universal power supply that allows operation in either 100/120V AC or 220/240V AC voltage area ( No user adjustment is required. )
3. Connect the power cord into your monitor's power input socket, and then plug the other end into a 3-pin AC power outlet. The power cord may be connected to either a wall power outlet or the power outlet socket on your PC, depending on the type of power cord supplied with your monitor.

**Power cord:**

For safe operation, use the power cord supplied with the unit.

**Notes**

- Do not install the monitor in a location near heat sources such as radiators or air ducts , or in a place subject to direct sunlight , or excessive dust or mechanical vibration or shock.
- Save the original shipping carton and packing materials, as they will come in handy if you ever have to ship your monitor.
- To keep the monitor looking new, periodically clean it with a soft cloth. Stubborn stains may be removed with a cloth lightly dampened with a mild detergent solution. Never use strong solvents such as thinner, benzene, or abrasive cleaners, since these will damage the cabinet. As a safety precaution, always unplug the monitor before cleaning it.

## Tilt/Swivel Base

---

- Turn Off the equipment and all attached options.
- Carefully set the monitor face-down with the underside facing you.

### Installation

1. Align the hooks on the tilt/swivel stand with the matching slots in the base of the monitor.
2. Insert the hooks into slots.
3. Slide the tilt/swivel stand toward the front of the monitor until the latches click into the locked position.

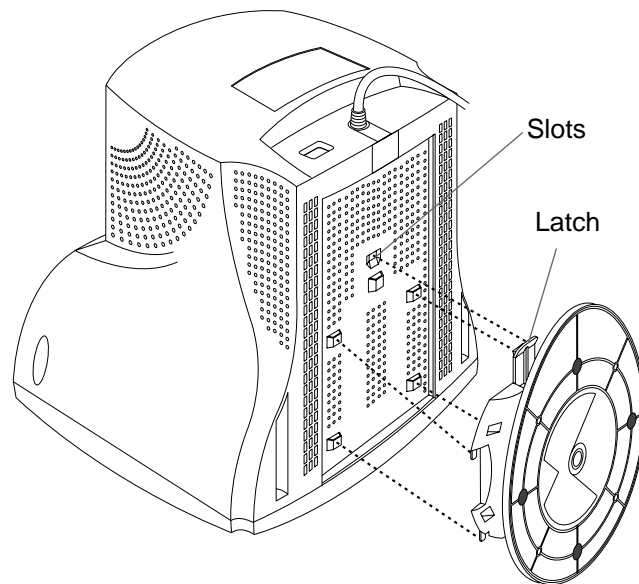

A5



## Connecting the Monitor

On the back of the monitor are two plug-in connections; one for the AC power cord, and the other for the signal cable from the video card.

- ① Power off both the monitor and PC.
- ② Connect the 15 pin VGA connector of the supplied signal cable to the output VGA video connector on the PC and the matching input connector on the rear of the monitor. The connectors will mate only one way. If you cannot attach the cable easily, turn the connector upside down and try again. When mated, tighten the thumbscrews to secure the connection.
- ② Locate the appropriate MAC to VGA adapter block at your local computer store. This adapter changes the high density 3 row 15 pin VGA connector to the correct 15 pin 2 row connection to mate with your MAC. Attach the other end of the signal cable to the side of the adapter block with 3 rows.  
Connect the attached adapter block/signal cable to the video output on your MAC.
- ③ One end of the AC power cord is connected into the AC power connector on the back of the monitor. The other end is plugged into a properly grounded three-prong AC outlet.
- ④ Power ON the PC, then the monitor.
- ⑤ If you see the **SELF DIAGNOSTICS** message, check the signal cable and connectors.
- ⑥ After using the system, power OFF the monitor, then the PC.

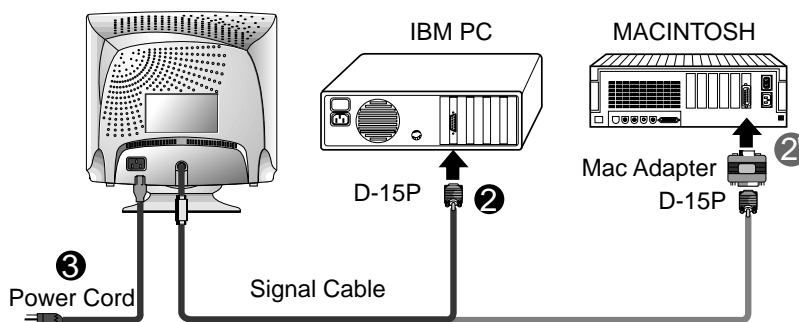

\* **NOTE** : For Apple Macintosh use, a separate plug adapter is needed to change the 15 pin high density (3 row) D-sub VGA connector on the supplied cable to a 15 pin 2 row connector.

## Location and Function of Controls

### Front View

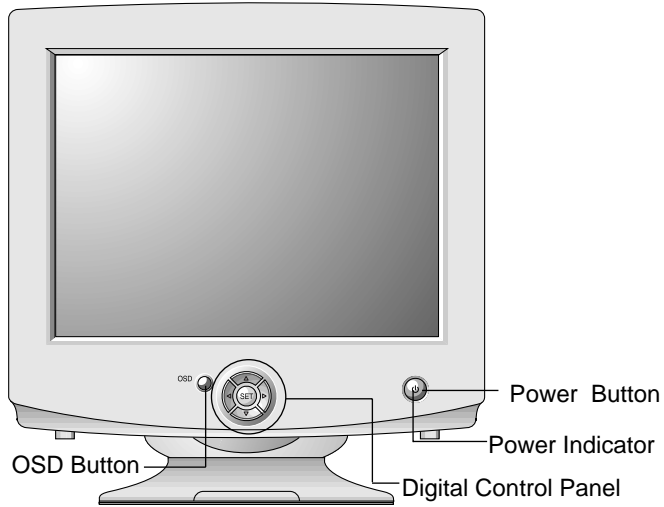



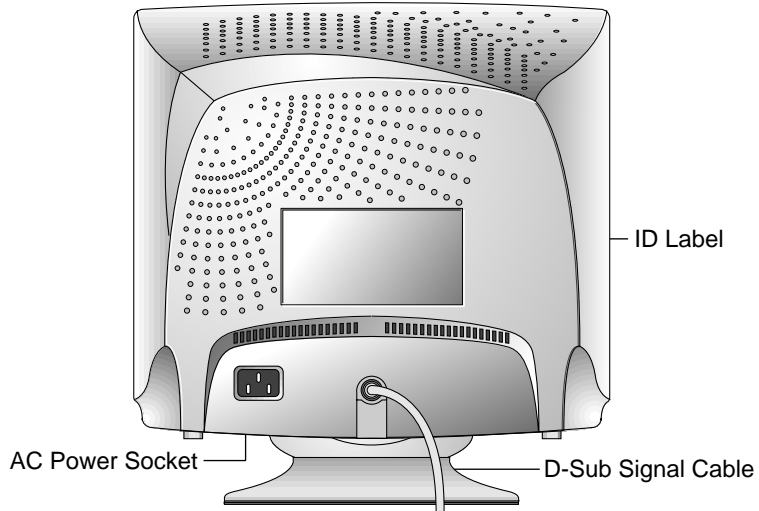

### Rear View

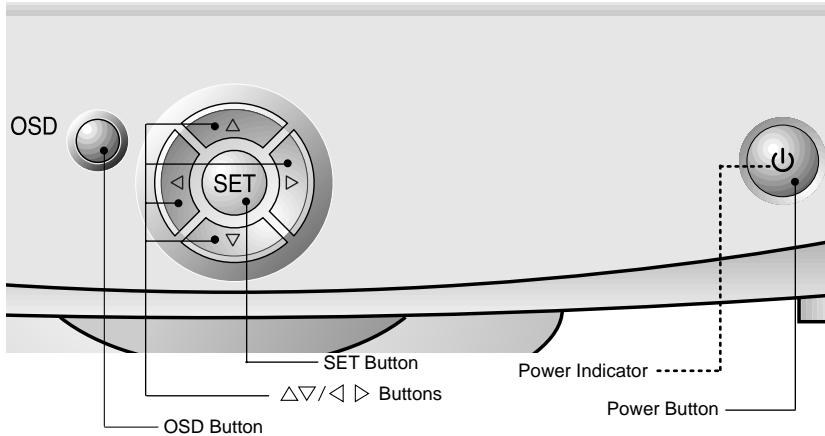

## Control Panel Function

### Front Panel Controls

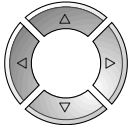

Control	Function
 <b>OSD Button</b>	Use this button to enter or exit the on screen display .
 <b>Δ▽/◀▶ Buttons</b>	Use these buttons to choose or adjust items in the on screen display.
 <b>SET Button</b>	Use this button to enter a selection in the on screen display.
 <b>Power Button</b>	Use this button to turn the monitor on or off.
<b>Power Indicator</b>	The power indicator light is shown in the power button. This indicator lights up green when the monitor operates normally. If the monitor is in DPM (Energy Saving) mode (stand-by/ suspend/power off), this indicator color changes to amber.

## On Screen Display (OSD) Control Adjustment

Making adjustments to the image size, position and operating parameters of the monitor are quick and easy with the On Screen Display Control system, using only the Enter button and Adjustment Control buttons. A quick example is given below to familiarize you with the use of the controls. Following this section is an outline of the available adjustments and selections you can make using the OSD.

**Note** : Allow the monitor to stabilize for at least 30 minutes before making image adjustment.

To make adjustments in the On Screen Display, follow these steps:

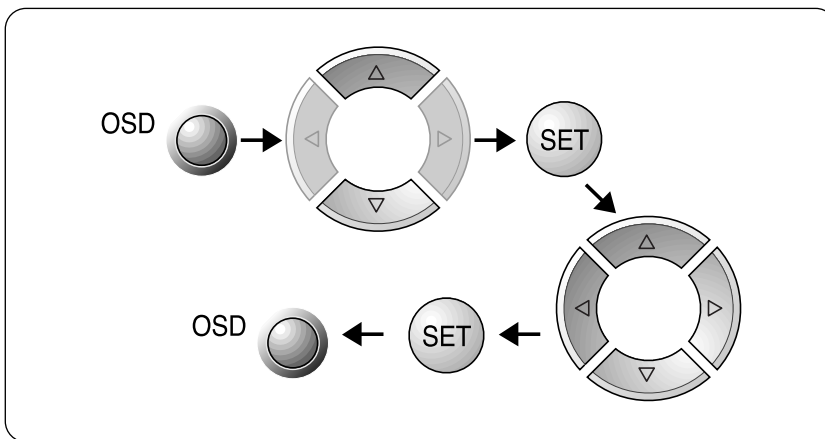

- 1** Press the **OSD Button**, then the main menu of the OSD appears.
- 2** To access a control, use the  $\Delta$  or  $\nabla$  **Buttons**. When the icon you want becomes highlighted, press the **SET Button**.
- 3** Use the  $\Delta/\nabla/\leftarrow/\rightarrow$  **Buttons** to adjust the item to the desired level.
- 4** Accept the changes by pressing the **SET Button**.
- 5** Exit the OSD by Pressing the **OSD Button**.

## On Screen Display(OSD) Selection and Adjustment

You were introduced to the procedure of selection and adjusting an item using the OSD system.

Listed below are the icons, icon names, and icon descriptions of the items that are shown on the Menu.

OSD Adjust	Description
------------	-------------

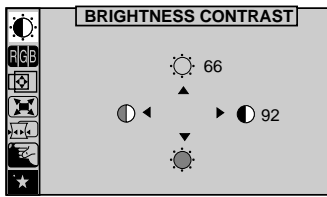

**Brightness**  
Used to adjust the brightness of the screen.

**Contrast**  
Adjust the display to the contrast desired.

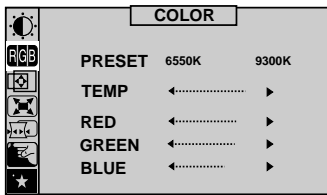

**PRESET 6550K/ 9300K**  
To appear the displays color temperature.  
 • 6550K:Slightly reddish white.  
 • 9300K:Slightly bluish white.

**TEMP**  
User easily color set without adjustment Red, Green and Blue (R/G/B).

**RED** To set your own color levels.

**GREEN** To set your own color levels.

**BLUE** To set your own color levels.

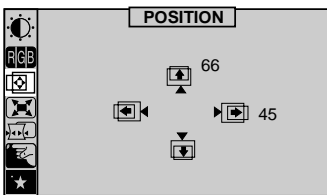

**Vertical Position**  
To move image up and down.

**Horizontal Position**  
To move picture image left and right.

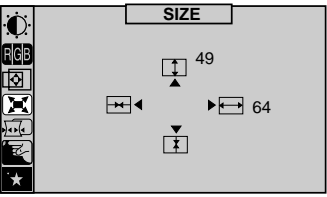
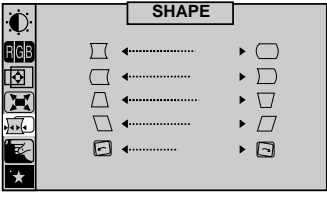
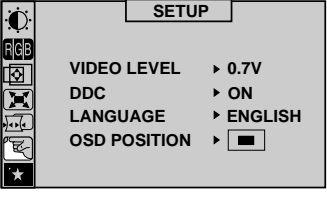
OSD Adjust	Description
	<p><b>Vertical Size</b> To adjust image height.</p> <p><b>Horizontal Size</b> To adjust image width.</p>
	<p><b>Side Pincushion</b> To correct the bowing in and out of the image.</p> <p><b>Side pincushion balance</b> To correct the balance of both sides bowling.</p> <p><b>Trapezoid</b> To correct geometric distortion.</p> <p><b>Parallelogram</b> This control adjusts for a skewing of the screen image.</p> <p><b>Tilt</b> To correct image rotation.</p>
	<p><b>VIDEO LEVEL</b> To select input signal Level.(0.7V/1.0V)</p> <p><b>DDC</b> To select the DDC function.(ON/OFF)</p> <p><b>LANGUAGE</b> To choose the language in which the control names are displayed.</p> <p><b>OSD POSITION</b> To adjust position of the OSD window on the screen.</p>

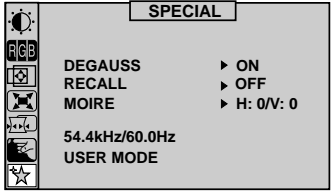
OSD Adjust	Description
 <p><b>SPECIAL</b></p> <ul style="list-style-type: none"> <li>DEGAUSS      ▶ ON</li> <li>RECALL        ▶ OFF</li> <li>MOIRE         ▶ H: 0/V: 0</li> <li>54.4kHz/60.0Hz</li> <li>USER MODE</li> </ul>	<p><b>DEGAUSS</b> To manually demagnetize the screen which may show some image or color incorrectly.</p>
	<p><b>RECALL</b> If the monitor is operating in a factory preset mode, this control will reset the image to the factory preset mode. If the monitor is operating in a user mode, this control has no effect.</p>
	<p><b>MOIRE</b> This item allows you to reduce the moire (Moire is caused by interference Horizontal Scan Line with the periodical dot screen). It is normally <b>OFF</b>(H:0/V:0) The moire adjustments may affect the focus of the screen.</p>

## Video Memory Modes

The monitor has 31 memory locations for display modes, 6 of which are factory preset to popular video modes.

### ■ Display Modes (Resolution)

Display Modes (Resolution)	Horizontal Frequency (kHz)	Vertical Frequency (Hz)
IND. 640 x 480	31.5	60
VESA 640 x 480	43.3	85
VESA 800 x 600	46.9	75
VESA 800 x 600	53.9	85
VESA 1024 x 768	60.0	75
VESA 1024 x 768	68.7	85

### ■ User Modes

The monitor can accept new video data. If the monitor detects a new video mode that has not been present before or is not one of the preset modes, it stores the new mode automatically in one of the empty modes starting with mode 7. If you use up the 25 blank modes and still have more new video modes, the monitor replaces the information in the user modes starting with mode 7.

The following modes have been pre-loaded for your convenience:

Display Modes (Resolution)	Horizontal Frequency (kHz)	Vertical Frequency (Hz)
IND. 720 x 400	31.5	70
VESA 640 x 480	37.5	75
IBM MF12	41.8	75
VESA 720 X 400	37.9	85

### ■ Recalling Display Modes

When your monitor detects a mode it has seen before, it automatically recalls the image settings you may have made the last time you used that mode.

You may, however, manually force a recall of each of the 6 preset modes by pressing the Recall button. All preset modes are automatically recalled as the monitor senses the incoming signal.

The ability to recall the preset modes is dependent on the signal coming from your PC's video card or system. If this signal does not match any of the factory modes, the monitor automatically sets itself to display the image.



## Energy Saving Design

This monitor complies with the EPA's Energy Star program, which is a program designed to have manufacturers of computer equipment build circuitry into their products to reduce power consumption during time of non-use.

This monitor also goes into its energy saving mode if you exceed the monitor's operating limits, such as the maximum resolution of 1024 x 768 or the frequency refresh rates of 30-70kHz horizontal or 50-160Hz vertical. When this monitor is used with a Green or EPA Energy Star PC, or a PC with a screen blanking software following the VESA Display Power Management Signalling (DPMS) protocol, this monitor can conserve significant energy by reducing power consumption during periods of non-use. When the PC goes into the energy saving mode, the monitor will go into a suspended operation state, indicated by the Power LED light changing from a green color to an amber color. After an extended period in the suspended mode, the monitor will then enter a semi-OFF mode to conserve more energy. In the semi-OFF mode or DPMS OFF mode as we call it in our specifications, the Power LED will still show an amber color. When you awaken your PC by hitting a key or moving the mouse, the monitor will also awaken to its normal operating mode, indicated by the green Power LED light. By following these conventions, the power consumption can be reduced to the following levels:

### Power Consumption

Mode	Hori. Sync	Verti. Sync	Video	Power Consumption	LED Color
Normal(Max.)	On	On	Normal	" 100W	Green
Stand-by	Off	On	Off	" 15W	Amber
Suspend	On	Off	Off	" 15W	Amber
Off	Off	Off	Off	" 5W	Amber

## Low Radiation Compliance (MPR II)

This monitor meets one of the strictest guidelines available today for low radiation emissions, offering the user extra shielding and an antistatic screen coating. These guidelines, set forth by a government agency in Sweden, limit the amount of emission allowed in the Extremely Low Frequency (ELF) and Very Low Frequency (VLF) electromagnetic range.

## Self Diagnostics



This monitor can sense when there is a possible problem present, and informs you of this condition by presenting you with a **SELF DIAGNOSTICS** OSD. This OSD may pop up when it is On but no signal is detected. In this case the message **CHECK SIGNAL CABLE** will be high lighted, alerting you to check the signal cable connections.

## DDC (Display Data Channel)

DDC is a communication channel over which the monitor automatically informs the host system (PC) about its capabilities. This monitor has DDC function; DDC2B carry out uni-directional communication between the PC and the monitor. Under these situations, the PC sends display data to the monitor but not commands to control the monitor settings.

**Note** : PC must support DDC functions to do this.

If your monitor is displaying a mono chrome image or the wrong resolution, select the DDC OFF function.

## Troubleshooting

---

### Self diagnostics message.

- The signal cable is not connected.
- 

### OUT OF FREQUENCY message appears.

- The frequency of the sync input is outside the operating range of the monitor.

\*Horizontal Frequency: 30-70kHz

\*Vertical Frequency: 50-160Hz

Use the graphics board's utility software to change the frequency setting (Refer to the manual for graphics board).

---

### The power LED is illuminated amber.

- Display power management mode.
  - There is no sync signal.
  - The signal cable is not fastened securely.
  - Check the computer power and graphics adapter configuration.
- 

### The image on the SCREEN is not centered, or too small, or not a rectangle shape.

- Image adjustment not been done yet in the current operating mode. Use the **OSD, SET** and  $\triangle \nabla / \triangleleft \triangleright$  buttons to set the image to your liking.
- 

### The monitor doesn't enter the power saving off mode (Amber).

- Computer video signal is not VESA DPMS standard. Either the PC or the video controller card is not using the VESA DPMS power management function.

**Note** : If the power indicator(LED) light is blinking amber, may result in abnormal condition of the monitor. Then press a power button on the front panel control and call your service technician for more information.

---

## Further help

---

If you are unable to correct the problem yourself, you may seek further help as follows:

**Call IBM HELPCENTER.**  
**In the US call 1-800-772-2227**  
**In Canada call 1-800-565-3344**

In other countries, contact your dealer, retailer, or other IBM authorized servicer.

Before calling, please have available as much of the following information as possible:

1. Type, model and serial number from the label on the back of your monitor.
2. Purchase receipt.
3. Description of problem.
4. Computer type and model.
5. System configuration(hardware fitted etc.).
6. System BIOS version number.
7. Operating System and version number.
8. Display driver version number.

If possible, stay by your computer system. Your technical support representative might want to go through the problem with you during the call.

## Service

---

Unplug the monitor from the wall outlet and refer servicing to qualified service personnel when :

- The power cord or plug is damaged or frayed.
- Liquid has been spilled into the monitor.
- The monitor has been exposed to rain or water.
- The monitor does not operate normally following the operating instructions. Adjust only those controls that are covered in the operating instructions. An improper adjustment of other controls may result in damage and often requires extensive work by a qualified technician to restore the monitor to normal operation.
- The monitor has been dropped or the cabinet has been damaged.
- The monitor exhibits a distinct change in performance.
- Snapping or popping from the monitor is continuous or frequent while the monitor is operating. It is normal for some monitors to make occasional sounds when being turned on or off, or when changing video modes.

---

Do not attempt to service the monitor yourself, as opening or removing covers may expose you to dangerous voltage or other hazards. Refer all servicing to qualified service personnel.

---

## Specifications

### Sync Signal type

Type	H. sync	V. sync
Separate sync	H. sync	V. sync

### Signal Connector Pin Assignment

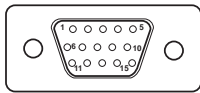

Pin	Separate Sync
1	Red
2	Green
3	Blue
4	Ground
5	Self-T est
6	Red Ground
7	Green Ground
8	Blue Ground
9	NC
10	Ground
11	Ground
12	SDA
13	Horiz.Sync
14	V ert.Sync
15	SCL

## Specifications

---

### Picture tube

- 15 inches (13.8 inches viewable) FST, 90° deflection
- 0.28 mm dot pitch, Non-glare, Darkface
- AR-ASC (Anti-Reflective Anti-Static Coating)

### Sync Input

- Horizontal Frequency : 30 - 70kHz (Automatic)
- Vertical Frequency : 50 - 160Hz (Automatic)
- Input Form : Separate, Positive/Negative
- Signal input : 15 pin D-Sub Connector

### Video Input

- Input Form : Separate, RGB Analog, 0.7 Vp-p/75 ohm, Positive
- Resolution : 1024 x 768, 85Hz

### Power Input

- 100-240VAC 50/60Hz 1.5A

### Dimensions (with tilt/swivel stand)

- Width : 360 mm/14.2 inches
- Depth : 391.5 mm/15.4 inches
- Height : 389.5 mm/15.3 inches

### Weight

- Net : 12.6kg (27.78lbs)

### Environment

- Operating condition
  - Temperature : 10°C to 40°C
  - Humidity : 10% to 90% non-condensing
- Storage condition
  - Temperature : 0°C to 60°C
  - Humidity : 5% to 90% non-condensing

## Compliances

---

### **Federal Communications Commission(FCC) Statement**

This equipment has been tested and found to comply with the limits for a Class B digital device, pursuant to Part 15 of the FCC Rules. These limits are designed to provide reasonable protection against harmful interference in a residential installation. This equipment generates, uses and can radiate radio frequency energy and, if not installed and used in accordance with the instructions, may cause harmful interference to radio communications. However, there is no guarantee that interference will not occur in a particular installation.

If this equipment does cause harmful interference to radio or television reception, which can be determined by turning the equipment off and on, the user is encouraged to try to correct the interference by one or more of the following measures:

- Reorient or relocate the receiving antenna.
- Increase the separation between the equipment and receiver .
- Connect the equipment into an outlet on a circuit different from that to which the receiver is connected.
- Consult an IBM authorized dealer or service representative for help.

Properly shielded and grounded cables and connectors must be used in order to meet FCC emission limits. Proper cables and connectors are available from IBM authorized dealers. IBM is not responsible for any radio or television interference caused by using other than recommended cables and connectors or by unauthorized changes or modifications to this equipment. Unauthorized changes or modifications could void the user's authority to operate the equipment.

This device complies with Part 15 of the FCC Rules. Operation is subject to the following two conditions: (1) this device may not cause harmful interference, and (2) this device must accept any interference received, including interference that may cause undesired operation.

### **Industry Canada Compliance Statement**

This Class B digital apparatus meets the requirements of the Canadian Interference-Causing Equipment Regulations.

Cet appareil numérique de la Classe B respecte toutes les exigences du Règlement sur le matériel brouilleur du Canada.



---

**Power Cord:**

For your safety, IBM provides a power cord with a grounded attachment plug to use with this IBM product. To avoid electrical shock, always use the power cord and plug with a properly grounded power outlet.

IBM power cords used in the United States and Canada are listed by the Underwriters Laboratories (UL) and certified by the Canadian Standards Association (CSA).

For units intended to be operated at 115 volts: Use a UL listed and CSA certified cord set consisting of a minimum 18 AWG, type SVT or SJT, three conductor cord, a maximum of 4.5 metres (15 feet) in length and a parallel blade, grounding type attachment plug rated 15 amperes, 125 volts.

For units intended to be operated at 230 volts (U.S. use): Use a UL listed and CSA certified cord set consisting of a minimum 18 AWG, type SVT or SJT, three conductor cord, a maximum of 4.5 metres (15 feet) in length and a tandem blade, grounding type attachment plug rated 15 amperes 250 volts.

For units intended to be operated at 230 volts (outside the U.S.): Use a cord set with a grounding type attachment plug rated 13 amperes (minimum), 250 volts. The cord set should be marked <HAR> and have the appropriate safety approvals for the country in which the equipment will be installed.



As an ENERGY STAR® Partner IBM Corporation has determined that this product meets the ENERGY STAR® guidelines for energy efficiency.

---

**MPR II**

This product complies with Swedish National Council for Metrology (MPR) standards issued in December 1990 (MPR II) for very low frequency (VLF) and extremely low frequency (ELF).

**European Union (EU) Statement**

This product has been tested and found to comply with the limits for Class B Information Technology Equipment according to CISPR 22/ European Standard EN 55022. The limits for Class B equipment were derived for typical residential environments to provide reasonable protection against interference with licensed communication devices. Properly shielded and grounded cables and connectors must be used in order to reduce the potential for causing interference to radio and TV communications and to other electrical or electronic equipment. Such cables and connectors are available from IBM authorized dealers. In accordance with EN 50082-1 1992, Performance Criterion A, it should be noted that in the presence of certain electromagnetic fields, some screen jitter may be observed.

**Service Information**

The following parts are for use by IBM service, or IBM authorized dealers, to support customer warranty. Parts are for service use only.

**Model Type 2278**

<b>Part Number</b>	<b>M/T-Model</b>	<b>Description</b>
04N7324	2278-06E	Monitor-UVEQ (pearl white)

## Warranty

### **Statement of Limited Warranty**

The warranties provided by IBM in this Statement of Limited Warranty apply only to Machines you originally purchase for your use, and not for resale, from IBM or your reseller. The term "Machine" means an IBM machine, its features, conversions, upgrades, elements, or accessories, or any combination of them. Unless IBM specifies otherwise, the following warranties apply only in the country where you acquire the Machine. If you have any questions, contact IBM or your reseller.

<b>Machine:</b>	A50 (M/T 2278)
<b>Warranty Period*:</b>	Three years
*Contact your place of purchase for warranty service information.	

### **Production Status**

Each Machine is manufactured from new parts, or new and used parts. In some cases, the Machine may not be new and may have been previously installed. Regardless of the Machine's production status, IBM's warranty terms apply.

### **The IBM Warranty for Machines**

IBM warrants that each Machine 1) is free from defects in materials and workmanship and 2) conforms to IBM's Official Published Specifications. The warranty period for a Machine is a specified, fixed period commencing on its Date of Installation. The date on your receipt is the Date of Installation, unless IBM or your reseller informs you otherwise.

During the warranty period IBM or your reseller, if authorized by IBM, will provide warranty service under the type of service designated for the Machine and will manage and install engineering changes that apply to the Machine.

For IBM or your reseller to provide warranty service for a feature, conversion, or upgrade, IBM or your reseller may require that the Machine on which it is installed be 1) for certain Machines, the designated, serial-numbered Machine and 2) at an engineering-change level compatible with the feature, conversion, or upgrade. Many of these transactions involve the removal of parts and their return to IBM. You represent that all removed parts are genuine and unaltered. A part that replaces a removed part will assume the warranty service status of the replaced part.

If a Machine does not function as warranted during the warranty period, IBM or your reseller will repair it or replace it with one that is at least functionally equivalent, without charge. The replacement may not be new, but will be in good working order. If IBM or your reseller is unable to repair or replace the Machine, you may return it to your place of purchase and your money will be refunded.

If you transfer a Machine to another user, warranty service is available to that user for the remainder of the warranty period. You should give your proof of purchase and this Statement to that user. However, for Machines which have a life-time warranty, this warranty is not transferable.

### **Warranty Service**

To obtain warranty service for the Machine, you should contact your reseller or call IBM. In the United States, call IBM at 1-800-772-2227. In Canada, call IBM at 1-800-565-3344. You may be required to present proof of purchase.

IBM or your reseller will provide certain types of repair and exchange service, either at your location or at IBM's or your reseller's service center, to restore a Machine to good working order.

When a type of service involves the exchange of a Machine or part, the item IBM or your reseller replaces becomes its property and the replacement becomes yours. You represent that all removed items are genuine and unaltered. The replacement may not be new, but will be in good working order and at least functionally equivalent to the item replaced. The replacement assumes the warranty service status of the replaced item. Before IBM or your reseller exchanges a Machine or part, you agree to remove all features, parts, options, alterations, and attachments not under warranty service. You also agree to ensure that the Machine is free of any legal obligations or restrictions that prevent its exchange.

You agree to:

1. obtain authorization from the owner to have IBM or your reseller service a Machine that you do not own; and
2. where applicable, before service is provided -
  - a. follow the problem determination, problem analysis, and service request procedures that IBM or your reseller provide,
  - b. secure all programs, data, and funds contained in a Machine, and
  - c. inform IBM or your reseller of changes in a Machine's location.

IBM is responsible for loss of, or damage to, your Machine while it is 1) in IBM's possession or 2) in transit in those cases where IBM is responsible for the transportation charges.

#### ***Extent of Warranty***

IBM does not warrant uninterrupted or error-free operation of a Machine.

The warranties may be voided by misuse, accident, modification, unsuitable physical or operating environment, improper maintenance by you, removal or alteration of Machine or parts identification labels, or failure caused by a product for which IBM is not responsible. THESE WARRANTIES REPLACE ALL OTHER WARRANTIES OR CONDITIONS, EXPRESS OR IMPLIED, INCLUDING, BUT NOT LIMITED TO, THE IMPLIED WARRANTIES OR CONDITIONS OF MERCHANTABILITY AND FITNESS FOR A PARTICULAR PURPOSE.

THESE WARRANTIES GIVE YOU SPECIFIC LEGAL RIGHTS AND YOU MAY ALSO HAVE OTHER RIGHTS WHICH VARY FROM JURISDICTION TO JURISDICTION. SOME JURISDICTIONS DO NOT ALLOW THE EXCLUSION OR LIMITATION OF EXPRESS OR IMPLIED WARRANTIES, SO THE ABOVE EXCLUSION OR LIMITATION MAY NOT APPLY TO YOU. IN THAT EVENT SUCH WARRANTIES ARE LIMITED IN DURATION TO THE WARRANTY PERIOD. NO WARRANTIES APPLY AFTER THAT PERIOD.

#### ***Limitation of Liability***

Circumstances may arise where, because of a default on IBM's part or other liability you are entitled to recover damages from IBM. In each such instance, regardless of the basis on which you are entitled to claim damages from IBM (including fundamental breach, negligence, misrepresentation, or other contract or tort claim), IBM is liable only for:

1. damages for bodily injury (including death) and damage to real property and tangible personal property; and
2. the amount of any other actual direct damages or loss, up to the greater of U. S. \$100,000 or the charges (if recurring, 12 months' charges apply) for the Machine that is the subject of the claim.

UNDER NO CIRCUMSTANCES IS IBM LIABLE FOR ANY OF THE FOLLOWING: 1) THIRD-PARTY CLAIMS AGAINST YOU FOR LOSSES OR DAMAGES (OTHER THAN THOSE UNDER THE FIRST ITEM LISTED ABOVE); 2) LOSS OF, OR DAMAGE TO, YOUR RECORDS OR DATA; OR 3) SPECIAL, INCIDENTAL, OR INDIRECT DAMAGES OR FOR ANY ECONOMIC CONSEQUENTIAL DAMAGES (INCLUDING LOST PROFITS OR SAVINGS), EVEN IF IBM OR YOUR RESELLER IS INFORMED OF THEIR POSSIBILITY. SOME JURISDICTIONS DO NOT ALLOW THE EXCLUSION OR LIMITATION OF INCIDENTAL OR CONSEQUENTIAL DAMAGES, SO THE ABOVE EXCLUSION OR LIMITATION MAY NOT APPLY TO YOU.