



L215 Wide Flat Panel Monitor User's Guide



Product numbers

6325-HB1

First Edition (January 2009)

© Copyright Lenovo 2009.

LENOVO products, data, computer software, and services have been developed exclusively at private expense and are sold to governmental entities as commercial items as defined by 48 C.F.R. 2.101 with limited and restricted rights to use, reproduction and disclosure.

LIMITED AND RESTRICTED RIGHTS NOTICE: If products, data, computer software, or services are delivered pursuant a General Services Administration "GSA" contract, use, reproduction, or disclosure is subject to restrictions set forth in Contract No. GS-35F-05925.

Contents

Safety information	iii
Chapter 1. Getting started	1-1
Shipping contents	1-1
Attaching the base and handling your monitor	1-2
Product overview	1-2
Adjusting the tilt	1-2
Swivel	1-2
Monitor controls	1-3
Cable lock slot	1-3
Setting up your monitor	1-4
Connecting and turning on your monitor	1-4
Registering your option	1-6
Chapter 2. Adjusting and using your monitor	2-1
Comfort and accessibility	2-1
Arranging your work area	2-1
Positioning and viewing your monitor	2-1
Quick tips for healthy work habits	2-2
Adjusting your monitor image	2-3
Using the direct access controls	2-5
Using the On-Screen Display (OSD) controls	2-3
Selecting a supported display mode	2-7
Understanding power management	2-8
Caring for your monitor	2-9
Detaching the monitor stand	2-9
Chapter 3. Reference information	3-1
Monitor specifications	3-1
Troubleshooting	3-3
Manual image setup	3-4
Manually installing the monitor driver	3-5
Service information	3-7
Appendix A. Service and Support	A-1
Online technical support	A-1
Telephone technical support	A-1
Worldwide telephone list	A-1
Appendix B. Notices	B-1
Trademarks	B-2

Safety information

Before installing this product, read the Safety Information.

مج، يجب قراءة دات السلامة

Antes de instalar este produto, leia as Informações de Segurança.

在安装本产品之前，请仔细阅读 **Safety Information** (安全信息)。

Prije instalacije ovog produkta obavezno pročitajte Sigurnosne Upute.

Před instalací tohoto produktu si přečtěte příručku bezpečnostních instrukcí.

Læs sikkerhedsforskrifterne, før du installerer dette produkt.

Ennen kuin asennat tämän tuotteen, lue turvaohjeet kohdasta Safety Information.

Avant d'installer ce produit, lisez les consignes de sécurité.

Vor der Installation dieses Produkts die Sicherheitshinweise lesen.

Πριν εγκαταστήσετε το προϊόν αυτό, διαβάστε τις πληροφορίες ασφάλειας (safety information).

לפני שתתקינו מוצר זה, קראו את הוראות הבטיחות.

A termék telepítése előtt olvassa el a Biztonsági előírásokat!

Prima di installare questo prodotto, leggere le Informazioni sulla Sicurezza.

製品の設置の前に、安全情報をお読みください。

본 제품을 설치하기 전에 안전 정보를 읽으십시오.

Пред да се инсталира овој продукт, прочитајте информацијата за безбедност.

Lees voordat u dit product installeert eerst de veiligheidsvoorschriften.

Les sikkerhetsinformasjonen (Safety Information) før du installerer dette produktet.

Przed zainstalowaniem tego produktu, należy zapoznać się z książką "Informacje dotyczące bezpieczeństwa" (Safety Information).

Antes de instalar este produto, leia as Informações sobre Segurança.

Перед установкой продукта прочтите инструкции по технике безопасности.

Pred inštaláciou tohto produktu si prečítajte bezpečnostné informácie.

Pred namestitvijo tega proizvoda preberite Varnostne informacije.

Antes de instalar este producto lea la información de seguridad.

Läs säkerhetsinformationen innan du installerar den här produkten.

安裝本產品之前，請先閱讀「安全資訊」。

Chapter 1. Getting started

This User's Guide contains detailed information on the your Flat Panel Monitor. For a quick overview, please see the Setup Poster that was shipped with your monitor.

Shipping contents

The product package should include the following items:

- *Setup Poster*
- *Monitor Safety, Troubleshooting, and Warranty Guide*
- *Reference and Driver CD*
- *Flat Panel Monitor*
- *Power Cord*
- *DVI Cable(exclude China mainland market)*
- *Analog Interface Cable - Attached to monitor*

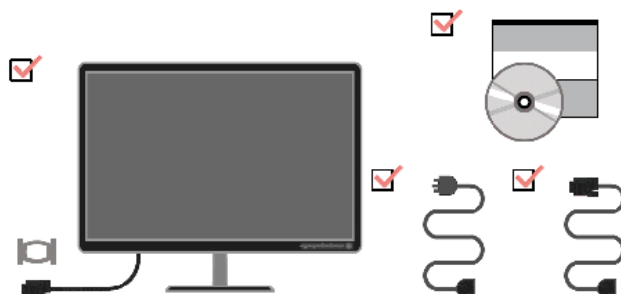

Attaching the base and handling your monitor

To set up your monitor, please see the illustrations below.

Note: Do not touch the monitor within the screen area. The screen area is glass and can be damaged by rough handling or excessive pressure.

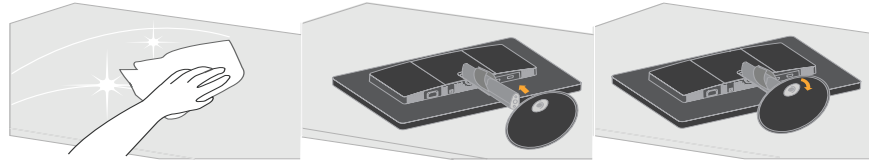

1. Carefully lay the monitor on a flat surface.
2. Assemble the base with the monitor's stand.
3. Tighten the screws clockwise at the bottom of the base.

Note: To attach a VESA mount, please see "Detaching the monitor stand" on page 2-9.

Product overview

This section will provide information on adjusting monitor positions, setting user controls, and using the cable lock slot.

Adjusting the tilt

The illustration below shows the tilt range of the monitor. For more information, see "Positioning your monitor" on page 2-1.



Swivel

With the built-in pedestal, you can swivel the monitor for the most comfortable viewing angle.

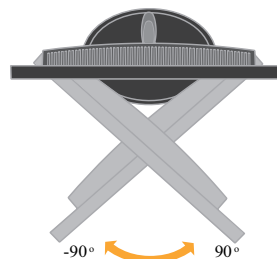

Monitor controls

Your monitor has controls on the front which are used to adjust the display.

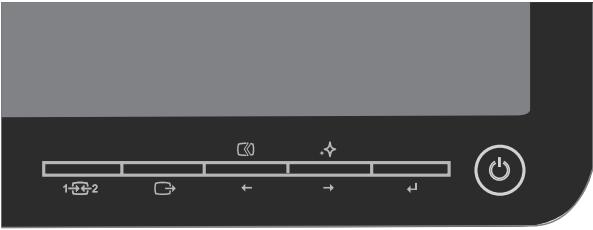

For information on how to use these controls, please see "Adjusting your monitor image" on page 2-3.

Cable lock slot

Your monitor is equipped with a cable lock slot located on the rear of your monitor (in the lower position). Please see the instructions that come with the cable lock to learn how to attach it.

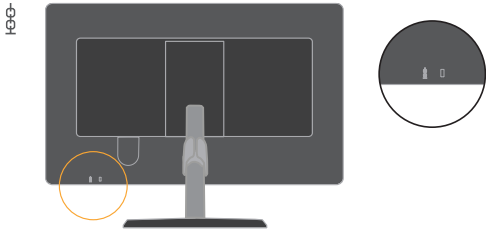

Setting up your monitor

This section provides information on how to set up your monitor.

Connecting and turning on your monitor

Note: Be sure to read the Safety Information located in the Monitor Safety, Troubleshooting, and Warranty Guide before carrying out this procedure.

1. Power off your computer and all attached devices, and unplug the computer power cord.



2. Connect the analog signal cable to the video port on the back of the computer.

Note: One end of the signal cable is already pre-attached to your monitor.

Place the cable into the specific hook indicated in below figure.

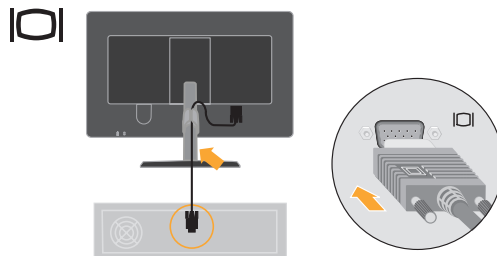

3. Connect the digital cable to the DVI connector of the monitor and the other end on the back of the computer.

Place the cable into the specific hook indicated in below figure.

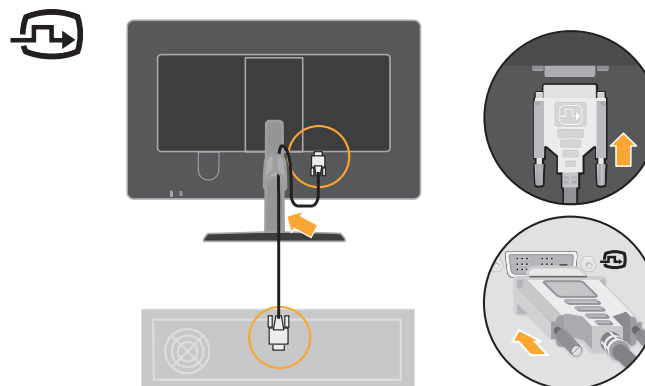

4. Insert the power cord into the monitor, then plug the monitor power cord and the computer cord into grounded electrical outlets.

Place the cable into the specific hook indicated in below figure.

Note: A certified power supply cord has to be used with this equipment. The relevant national installation and/or equipment regulations shall be considered. A certified power supply cord not lighter than ordinary polyvinyl chloride flexible cord according to IEC 60227 (designation H05VV-F 3G 0.75mm² or H05VVH2-F2 3G0.75mm²) shall be used. Alternative a flexible cord be of synthetic rubber according to IEC 60245 (designation H05RR-F 3G 0.75mm²) shall be used.

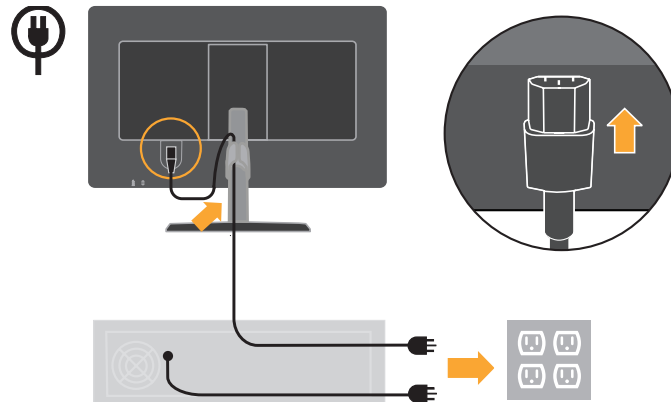

5. Side view after all cables have been placed.

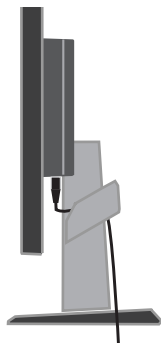

6. Power on the monitor and the computer.

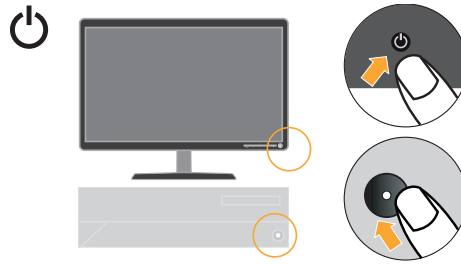

7. To install the monitor driver, insert the Reference and Driver CD, click Install driver, and follow the on-screen instructions.



8. To optimize your monitor image, press the Automatic Image Setup key. Automatic image setup requires that the monitor is warmed up for at least 15 minutes. This is not required for normal operation.



Note: If automatic image setup does not establish the image that you prefer, perform manual image setup. See “Manual image setup” on page 3-4 .

Registering your option

Thank you for purchasing this Lenovo® product. Please take a few moments to register your product and provide us with information that will help Lenovo to better serve you in the future. Your feedback is valuable to us in developing products and services that are important to you, as well as in developing better ways to communicate with you. Register your option on the following Web site:

<http://www.lenovo.com/register>

Lenovo will send you information and updates on your registered product unless you indicate on the Web site questionnaire that you do not want to receive further information.

Chapter 2. Adjusting and using your monitor

This section will give you information on adjusting and using your monitor.

Comfort and accessibility

Good ergonomic practice is important to get the most from your personal computer and to avoid discomfort. Arrange your workplace and the equipment you use to suit your individual needs and the kind of work that you perform. In addition, use healthy work habits to maximize your performance and comfort while using your computer. For more detailed information on any of these topics, visit the Healthy Computing Web site at: <http://www.lenovo.com/healthycomputing/>.

Arranging your work area

Use a work surface of appropriate height and available working area to allow you to work in comfort.

Organize your work area to match the way you use materials and equipment. Keep your work area clean and clear for the materials that you typically use and place the items that you use most frequently, such as the computer mouse or telephone, within the easiest reach.

Equipment layout and setup play a large role in your working posture. The following topics describe how to optimize equipment setup to achieve and maintain good working posture.

Positioning your monitor

Position and adjust your computer monitor for comfortable viewing by considering the following items:

- **Viewing distance:** Optimal viewing distances for monitors range from approximately 510mm to 760mm (20 in to 30 in) and can vary depending on ambient light and time of day. You can achieve different viewing distances by repositioning your monitor or by modifying your posture or chair position. Use a viewing distance that is most comfortable for you.
- **Monitor height:** Position the monitor so your head and neck are in a comfortable and neutral (vertical, or upright) position. If your monitor does not have height adjustments, you might have to place books or other sturdy objects under the base of the monitor to achieve the desired height. A general guideline is to position the monitor such that the top of the screen is at or slightly below your eye-height when you are comfortably seated. However, be sure to optimize your monitor height so the line of site between your eyes and the center the monitor suits your preferences for visual distance and comfortable viewing when your eye muscles are in a relaxed state.
- **Tilt:** Adjust the tilt of your monitor to optimize the appearance of the screen content and to accommodate your preferred head and neck posture.
- **General location:** Position your monitor to avoid glare or reflections on the screen from overhead lighting or nearby windows.

The following are some other tips for comfortable viewing of your monitor:

- Use adequate lighting for the type of work you are performing.

- Use the monitor brightness, contrast, and image adjustment controls, if equipped, to optimize the image on your screen to meet your visual preferences.
- Keep your monitor screen clean so you can focus on the screen's contents.

Any concentrated and sustained visual activity can be tiring for your eyes. Be sure to periodically look away from your monitor screen and focus on a far object to allow your eye muscles to relax. If you have questions on eye fatigue or visual discomfort, consult a vision care specialist for advice.

Quick tips for healthy work habits

The following information is a summary of some important factors to consider to help you remain comfortable and productive while you use your computer.

- **Good posture starts with equipment setup:** The layout of your work area and the setup of your computer equipment have a large effect on your posture while using your computer. Be sure to optimize the position and orientation of your equipment by following the tips outlined in "Arranging your work area" on page 2-1 so you can maintain a comfortable and productive posture. Also, be sure to use the adjustment capabilities of your computer components and office furniture to best suit your preferences now and as your preferences change over time.
- **Minor changes in posture can help avoid discomfort:** The longer you sit and work with your computer, the more important it is to observe your working posture. Avoid assuming any one posture for an extended period of time. Periodically make minor modifications in your posture to help deter any discomforts that might arise. Make use of any adjustments that your office furniture or equipment provide to accommodate changes in posture.
- **Short, periodic breaks help ensure healthy computing:** Because computing is primarily a static activity, it is particularly important to take short breaks from your work. Periodically, stand up from your work area, stretch, walk for a drink of water, or otherwise take a short break from using your computer. A short break from work gives your body a welcome change in posture and helps to ensure you remain comfortable and productive while you do work.





Adjusting your monitor image

This section describes the control features to adjust your monitor image.

Using the direct access controls

The direct access controls can be used when the On Screen Display (OSD) is not displayed.

Table 2-1. Direct access controls

Icon	Control	Description
	Input Change	Switches the video input source.
	DDC-CI	Press and hold for 10 seconds to enable or disable the DDC-CI function.
	Exit	Exit from menu
	Image Setup	Activates automatic image adjustment.
	NOVO VISION	Direct access to NOVO VISION adjustment.
	Menu	Enter menu

Using the On-Screen Display (OSD) controls

To adjust the settings, the user controls can be viewed through the OSD.

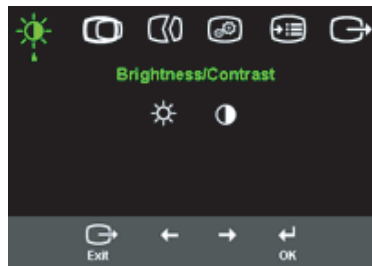

To use the controls:

1. Press \leftarrow to open the main OSD menu.
2. Use \leftarrow or \rightarrow to move among the icons. Select an icon and press \leftarrow to access that function. If there is a sub-menu, you can move between options using \leftarrow or \rightarrow , then press \leftarrow to select that function. Use \leftarrow or \rightarrow to make adjustments. Press \leftarrow to save.
3. Press \rightarrow to move backwards through the sub-menus and exit from the OSD.
4. Press and hold \leftarrow for 10 seconds to lock the OSD. This will prevent accidental adjustments to the OSD. Press and hold \leftarrow for 10 seconds to unlock the OSD and allow adjustments to the OSD.
5. Enables DDC/CI by default. Use OSD Exit Key, Press and hold the \rightarrow button for 10 seconds to disable / enable DDC/CI function. The words "DDC/CI disable" shows on the screen.

Table 2-2. OSD functions































OSD Icon on Main Menu	Submenu	Description	Controls and Adjustments (Analog)		Controls and Adjustments (Digital)
 Brightness/ Contrast	 Brightness	Adjusts overall brightness	 ←	 →	Same as Analog
	 Contrast	Adjusts difference between light and dark areas	 ←	 →	
 Image Position	 Horizontal Position	Moves the image left or right.	 ←	 →	Controls Locked - not required for digital input
	 Vertical Position	Moves the image up or down.	 ←	 →	
 Image Setup	 Automatic	Automatically optimizes the image.			
	 Manual	Manually optimizes the image. See "Manual image setup" on page 3-4. <ul style="list-style-type: none"> • Clock • Phase • Save 			
 Image Properties	 Color	Adjusts intensity of red, green, and blue. Preset mode <ul style="list-style-type: none"> • Neutral • sRGB • Reddish • Bluish Custom <ul style="list-style-type: none"> • Red: Increases or decreases the saturation of 'red' in the image. • Green: Increases or decreases the saturation of 'green' in the image. • Blue: Increases or decreases the saturation of 'blue' in the image. • Save: Saves the custom color choices. • 			Same as Analog
	 Input video signal	This monitor can accept video signals through two different connectors. Most desktop computers use a D-SUB connector. Select digital among OSD Controls when you use DVI connector. - Selects D-SUB (Analog) - Selects DVI-Digital			

Table 2-2. OSD functions

OSD Icon on Main Menu	Submenu	Description	Controls and Adjustments (Analog)	Controls and Adjustments (Digital)
	 NOVO VISION	Optimize screen for specific tasks		Same as Analog
	 Scaling	<ul style="list-style-type: none"> Original AR :same aspect ratio with input signal Full Screen : expand image to full screen 		
 Options	 Information	Shows resolution, refresh rate, and product details. Note: This screen does not allow any changes to the settings.		Same as Analog
	 Menu Language	This section lists the languages supported by your monitor. Note: The language chosen only affects the language of the OSD. It has no effect on any software running on the computer.		
	 Menu Position	Menu position adjusts menu location on the screen. Default Default returns the menu position to the default settings. Custom <ul style="list-style-type: none"> Horizontal: Changes the horizontal position of the OSD. Vertical: Changes the vertical position of the OSD. Save 		Same as Analog
	 factory default	<ul style="list-style-type: none"> Cancel Reset Resets monitor to the original factory settings.		
	 Accessibility	Controls button and menu settings for accessibility preferences. <ul style="list-style-type: none">  Button repeat rate: Select ← or → to change. <ul style="list-style-type: none"> Off Default Slow  Menu time out: Sets the length of time the OSD will remain active after the last time a button is pressed. <ul style="list-style-type: none"> Off Default Slow 		

Selecting a supported display mode

The display mode the monitor uses is controlled by the computer. Therefore, refer to your computer documentation for details on how to change display modes.

The image size, position and shape might change when the display mode changes. This is normal and the image can be readjusted using automatic image setup and the image controls.

Unlike CRT monitors, which require a high refresh rate to minimize flicker, LCD or Flat Panel technology is inherently flicker-free.

Note: If your system has previously been used with a CRT monitor and is currently configured to a display mode outside the range of this monitor, you may need to re-attach the CRT monitor temporarily until you have re-configured the system; preferably to 1920 x 1080 at 60 Hz, which is the Native Resolution Display mode.

The display modes shown below have been optimized at the factory.

Table 2-3. Factory set display modes

Addressability	Refresh rate
NTSC	60Hz
PAL	50Hz
640 x 350	70Hz
640 x 480	60 Hz, 72 Hz, 75 Hz
800 x 600	56 Hz, 60 Hz, 75 Hz
832 x 624	75Hz
1152 x 864	75Hz
1024 x 768	60 Hz, 70 Hz, 75 Hz
1280 x 1024	60 Hz, 70 Hz, 75 Hz
1440 x 900	60 Hz, 75Hz
1680 x 1050	60 Hz
1680 x 1050	75Hz (only VGA)
1920 x 1080	60 Hz

Understanding power management

Power management is invoked when the computer recognizes that you have not used your mouse or keyboard for a user-definable period. There are several states as described in the table below.

For optimal performance, switch off your monitor at the end of each working day, or whenever you expect to leave it unused for long periods during the day.

Table 2-4. Power indicator

State	Power Indicator	Screen	Restoring Operation	Compliance
On	Steady blue	Normal		
Standby/Suspend	Amber	Blank	Press a key or move the mouse There may be a slight delay before the image reappears. Note: Standby also occurs if there is no image output to the monitor.	ENERGY STAR
Off	Off	Blank	Press the power button There may be a slight delay before the image reappears.	ENERGY STAR

Caring for your monitor

Be sure to turn off the power before you perform any maintenance on the monitor.

Do not:

- Apply water or liquid directly to your monitor.
- Use solvents or abrasives.
- Use flammable cleaning materials to clean your monitor or any other electrical equipment.
- Touch the screen area of your monitor with sharp or abrasive items. This type of contact may cause permanent damage to your screen.
- Use any cleaner which contains an anti-static solution or similar additives. This may harm the coating of the screen area.

Do:

- Lightly dampen a soft cloth with water and use this to gently wipe the covers and the screen.
- Remove grease or finger marks with a damp cloth and a little mild detergent.

Detaching the monitor stand

To detach the base by pressing the button.

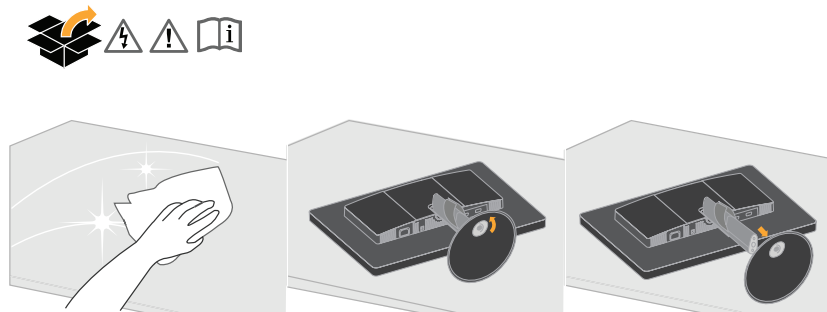

1. Carefully lay the monitor on a flat surface.
2. Loosen the screws anticlockwise at the bottom of the base.
3. Detaching the base from the monitor's stand.

Chapter 3. Reference information

This section contains monitor specifications, instructions to manually install the monitor driver, troubleshooting information, and service information.

Monitor specifications

Table 3-1. Monitor specifications for type-model 6325-HB1

Dimensions	Height	391.0 mm (15.39 in.)
	Depth	180.2 mm (7.09 in.)
	Width	512.3 mm (20.17 in.)
Stand	Tilt	Range: -5°, +20°
VESA mount	Supported	75 mm (2.95 in.)
Image	Viewable image size	546.86 mm(21.53 in.)
	Maximum height	476.64 mm(18.77 in.)
	Maximum width	268.11 mm (10.56 in.)
	Pixel pitch	0.248 mm (0.01 in.) (V)
Power input	Supply voltage	90-264VAC (100~240VAC+/-10%)
	Max supply current	1.5 A
Power consumption	Normal operation	< 45 W
Note: Power consumption figures are for the monitor and the power supply combined.	Standby/Suspend	<1W(Analog),< 1W(Digital)
	Off	< 0.5W at 100Vac & 240Vac
	Video input (Analog)	Input signal
Video input (Analog)	Horizontal addressability	1920 pixels (max)
	Vertical addressability	1080 lines (max)
	Clock frequency	210 MHz
	Video input (Digital)	Interface
Video input (Digital)	Input Signal	VESA TMDS (Panel Link™)
	Horizontal addressability	1920 pixels (max)
	Vertical addressability	1080 lines (max)
	Clock frequency	170 MHz

Table 3-1. Monitor specifications for type-model 6325-HB1

Communications	VESA DDC	CI
Supported Display Modes (VESA Standard modes between noted ranges)	Horizontal frequency	30 kHz - 83 kHz(Pixel clock <210MHz)
	Vertical frequency	50 Hz - 75 Hz(Pixel clock <210MHz)
	Native Resolution	1920 x 1080 at 60 Hz
Temperature	Operating	0° to 40° C (32° to 104° F)
	Storage	-20° to 60° C (-4° to 140° F)
	Shipping	-20° to 60° C (-4° to 140° F)
Humidity	Operating	8% to 80% non-condensing
	Storage	5% to 95% non-condensing
	Shipping	5% to 95% non-condensing

Troubleshooting

If you have a problem setting up or using your monitor, you might be able to solve it yourself. Before calling your dealer or Lenovo, try the suggested actions that are appropriate to your problem.

Table 3-2. Troubleshooting

Problem	Possible cause	Suggested action	Reference
The words "Out of Range" are shown on the screen, and the power indicator is flashing blue.	The system is set to a display mode which is not supported by the monitor.	<p>If you are replacing an old monitor, reconnect it and adjust the display mode to within the specified range for your new monitor.</p> <p>If using a Windows system, restart the system in safe mode, then select a supported display mode for your computer.</p> <p>If these options do not work, contact the Support Center.</p>	"Selecting a supported display mode" on page 2-7
The image quality is unacceptable.	The video signal cable is not connected with the monitor or system completely.	Be sure the signal cable is firmly plugged into the system and monitor.	"Connecting and turning on your monitor" on page 1-4
	The color settings may be incorrect.	Select another color setting from the OSD menu.	"Adjusting your monitor image" on page 2-3
	The automatic image setup function was not performed.	Perform automatic image setup.	"Adjusting your monitor image" on page 2-3
The power indicator is not lit and there is no image.	<ul style="list-style-type: none"> The monitor's power switch is not switched on. The power cord is loose or disconnected. There is no power at the outlet. 	<ul style="list-style-type: none"> Be sure the power cord is connected properly. Be sure the outlet has power. Power on the monitor. Try using another power cord. Try using another electrical outlet. 	"Connecting and turning on your monitor" on page 1-4
Screen is blank and power indicator is steady amber or flashing blue	The monitor is in Standby/Suspend mode	<ul style="list-style-type: none"> Press any key on the keyboard or move the mouse to restore operation. Check the Power Options settings on your computer. 	"Understanding power management" on page 2-8









Table 3-2. Troubleshooting

Problem	Possible cause	Suggested action	Reference
The power indicator is blue, but there is no image.	The video signal cable is loose or disconnected from the system or monitor.	Be sure the video cable is connected with the system properly.	"Connecting and turning on your monitor" on page 1-4
	The monitor brightness and contrast are at the lowest setting.	Adjust the brightness and contrast setting on the OSD menu.	"Adjusting your monitor image" on page 2-3
One or more of the pixels appear discolored	This is a characteristic of the LCD technology and is not an LCD defect.	If there are more than five pixels missing, contact the Support Center.	Appendix A, "Service and Support," on page A-1
<ul style="list-style-type: none"> Fuzzy lines in text or a blurry image. Horizontal or vertical lines through the image. 	<ul style="list-style-type: none"> Image setup has not been optimized Your system Display Properties setting have not been optimized. 	Adjust the resolution settings on your system to match the native resolution for this monitor: 1920 x 1080 at 60 Hz.	"Adjusting your monitor image" on page 2-3 "Manual image setup"
		Perform automatic image setup. If automatic image setup does not help, perform manual image setup.	"Selecting a supported display mode" on page 2-7
		When working in the native resolution, you may find additional improvements by adjusting the Dots Per Inch (DPI) setting on your system.	See the Advanced section of your system's display properties.

Manual image setup

If automatic image setup does not establish the image that you prefer, perform manual image setup.

Note: Have your monitor powered on for about 15 minutes, until the monitor warms up.

1. Press  at the bottom of the monitor to open the OSD menu.
2. Use  or  to select  and press  to access.
3. Use  or  to select **Clock** and **Phase** adjustment.
 - **Clock** (pixel frequency) adjusts the number of pixels scanned by one horizontal sweep. If the frequency is not correct, the screen shows vertical stripes and the picture does not have the correct width.
 - **Phase** adjusts the phase of the pixel clock signal. With a wrong phase adjustment, the picture has horizontal disturbances in light picture.
4. When the image no longer looks distorted, save the Clock and Phase adjustments.
5. Press  to leave the OSD menu.

Manually installing the monitor driver

Below are steps for manually installing the monitor driver in Microsoft® Windows XP® Microsoft Windows Vista. Please see the Install Driver section of the *Reference and Driver CD* for automatic installation.

Installing the monitor driver in Windows Vista

To use the Plug and Play feature Microsoft Windows Vista, do the following:

Note: You must download file from the Lenovo Monitor CD to use the Plug and Play feature in Windows Vista.

1. Turn off the computer and all attached devices.
2. Ensure that the monitor is connected correctly.
3. Turn on the monitor and then the system unit. Allow your computer to start the Windows Vista operating system.
4. Open the **Display Properties** window by clicking **Start, Control Panel** and then double-clicking the **Hardware and Sound** icon.
5. Click the **Personalization** icon.
6. Click the **Display Settings** icon.
7. Click the **Advanced Settings** button.
8. Click the **Monitor** tab.
9. Click the **Properties** button.
10. Click the **Driver** tab.
11. Open the "**Update Driver Software-Generic PnP Monitor**" window by clicking on **Update Driver** and then click the "**Browse my computer for driver software**" button.
12. Select "**Let me pick from a list of device drivers on my computer**".
13. Click the **Have Disk** button. Click on the **Browse** button and navigate to the following directory:
X:\Monitor Drivers\Windows Vista
(where X is the drive letter designator for the CD-ROM drive).
14. Select the "**LEN6521.inf**" file and click the **Open** button. Click the **OK** button.
15. Select **LEN L215wA** and click **Next**. The files will be copied from the CD to your hard disk drive.
16. Close all open windows and remove the CD.
17. Restart the system. The system will automatically select the maximum refresh rate and corresponding Color Matching Profiles.

Note: On LCD monitors, unlike CRTs, a faster refresh rate does not improve display quality. Lenovo recommends using either 1920 x 1080 at a refresh rate of 60 Hz, or 640 x 480 at a refresh rate of 60 Hz.

Installing the monitor driver in Windows XP

To use the Plug and Play feature in Windows XP, files should be loaded from the *Reference and Driver CD*.

Note: This section must be completed before continuing with the Windows XP automatic image setup.

1. Turn off the computer and all attached devices.
2. Ensure that the monitor is connected correctly.
3. Turn on the monitor and then the system unit. Allow the system to boot into Windows XP.
4. Open the **Display Properties** window by clicking **Start** → **Settings** → **Control Panel**, and then double-clicking the **Display** icon.
5. Click the **Settings** tab.
6. Click the **Advanced** button.
7. Click the **Monitor** tab.
8. Click the **Properties** button.
9. Click the **Drivers** tab.
10. Open the **Hardware Update Wizard** window by clicking on **Update Driver**, and then click **Next**.
11. Select **Install from a list or Specific location(Advanced)**, and then click **Next**.
12. Select "**Don't search. I will choose the driver to install**" option, and then click **Next**.
13. Click the **Have Disk** button. Click on the **Browse** button and navigate to the following directory:
X:\Monitor Drivers\Windows XP
(where X is the drive letter designator for the CD-ROM drive).
14. Select the "**LEN6521.inf**" file and click the **Open** button. Click the **OK** button.
15. Select **LEN L215wA** and click **Next**. The files will be copied from the CD to your hard disk drive.
16. Close all open windows and remove the CD.
17. Restart the system. The system will automatically select the maximum refresh rate and corresponding Color Matching Profiles.

Note: On LCD monitors, unlike CRTs, a faster refresh rate does not improve display quality. Lenovo recommends using either 1920 x 1080 at a refresh rate of 60 Hz, or 640 x 480 at a refresh rate of 60 Hz.

Service information

Product numbers

The product number for your monitor is located on the rear cover as shown below.

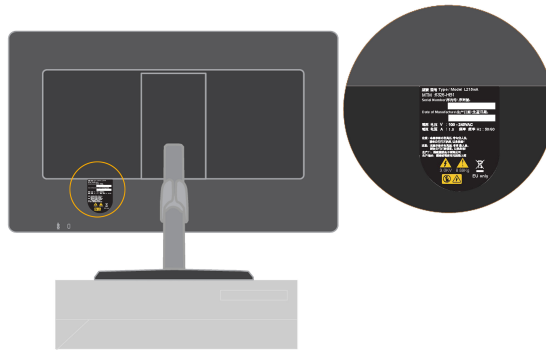

Customer responsibilities

The warranty does not apply to a product which has been damaged due to accident, misuse, abuse, improper installation, usage not in accordance with product specifications and instructions, natural or personal disaster, or unauthorized alterations, repairs or modifications.

The following are examples of misuse or abuse and not covered by warranty:

- Images burned onto the screen of a CRT monitor. Burned image is preventable by utilizing a moving screen saver or power management.
- Physical damage to covers, bezel, base and cables.
- Scratches or punctures on monitor screens.

Service parts

The following parts are for use by Lenovo service, or Lenovo authorized dealers, to support the customer warranty. Parts are for service use only. The table below shows information for model 6325-xx1.

Table 3-3. List of service parts

FRU(Field Replaceable unit) Part number	DESCRIPTION	Machine Type model (MTM)	COLOR
45J8720	L215 Wide-FRU Monitor	6325- HB1	Black
30R5139	L215 Wide-Analog cable	6325- HB1	Black
45J8721	L215 Wide-DVI cable	6325- HB1	Black
45J8726	L215 Wide -Clean Rag (same to L215p wide)	6325- HB1	Black
45J8722	L215 Wide-FRU Stand.	6325- HB1	Black

Appendix A. Service and Support

The following information describes the technical support that is available for your product, during the warranty period or throughout the life of the product. Refer to your Lenovo Statement of Limited Warranty for a full explanation of Lenovo warranty terms.

Online technical support

Online technical support is available during the life of your product through the Lenovo Support Web site at <http://www.lenovo.com/think/support>.

During the warranty period, assistance for replacement or exchange of defective components is available. In addition, if your option is installed in a Lenovo computer, you might be entitled to service at your location. Your technical support representative can help you determine the best alternative.

Telephone technical support

Installation and configuration support through the Customer Support Center will be withdrawn or made available for a fee, at Lenovo's discretion, 90 days after the option has been withdrawn from marketing. Additional support offerings, including step-by-step installation assistance, are available for a nominal fee.

To assist the technical support representative, have available as much of the following information as possible:

- Option name
- Option number
- Proof of purchase
- Computer manufacturer, model, serial number, and manual
- Exact wording of the error message (if any)
- Description of the problem
- Hardware and software configuration information for your system

If possible, be at your computer. Your technical support representative might want to walk you through the problem during the call.

Worldwide telephone list

Phone numbers are subject to change without notice. For the most current phone numbers, go to <http://www.lenovo.com/think/support> and click **Support phone list**.

Country or Region	Telephone Number
Africa	Africa: +44 (0)1475-555-055 South Africa: +27-11-3028888 and 0800110756 Central Africa: Contact your Lenovo Service provider
Argentina	0800-666-0011 (Spanish)
Australia	131-426 (English)

Country or Region	Telephone Number
Austria	Up and running support: 01-24592-5901 Warranty service and support: 01-211-454-610 (German)
Belgium	Up and running support: 02-210-9820 (Dutch) Up and running support: 02-210-9800 (French) Warranty service and support: 02-225-3611 (Dutch, French)
Bolivia	0800-0189 (Spanish)
Brazil	Sao Paulo region: (11) 3889-8986 Toll free outside Sao Paulo region: 0800-7014-815 (Brazilian Portuguese)
Canada	1-800-565-3344 (English, French) In Toronto only call: 416-383-3344
Chile	800-224-488 (Spanish)
China	800-810-1818 (Mandarin)
China (Hong Kong S.A.R.)	Home PC: 852-2825-7799 Commercial PC: 852-8205-0333 ThinkPad and WorkPad: 852-2825-6580 (Cantonese, English, Putonghua)
Colombia	1-800-912-3021 (Spanish)
Costa Rica	284-3911 (Spanish)
Croatia	0800-0426
Cyprus	+357-22-841100
Czech Republic	+420-2-7213-1316
Denmark	Up and running support: 4520-8200 Warranty service and support: 7010-5150 (Danish)
Dominican Republic	566-4755 566-5161 ext. 8201 Toll Free within the Dominican Republic: 1-200-1929 (Spanish)
Ecuador	1-800-426911 (Spanish)
El Salvador	250-5696 (Spanish)
Estonia	+386-61-1796-699
Finland	Up and running support: 09-459-6960 Warranty service and support: +358-800-1-4260 (Finnish)
France	Up and running support: 0238-557-450 Warranty service and support (hardware): 0810-631-213 Warranty service and support (software): 0810-631-020 (French)
Germany	Up and running support: 07032-15-49201 Warranty service and support: 01805-25-35-58 (German)
Greece	+30-210-680-1700
Guatemala	335-8490 (Spanish)
Honduras	Tegucigalpa & San Pedro Sula: 232-4222 San Pedro Sula: 552-2234 (Spanish)

Country or Region	Telephone Number
Hungary	+36-1-382-5720
India	1600-44-6666 Alternate Toll Free: +91-80-2678-8940 (English)
Indonesia	800-140-3555 +62-21-251-2955 (English, Bahasa, Indonesian)
Ireland	Up and running support: 01-815-9202 Warranty service and support: 01-881-1444 (English)
Italy	Up and running support: 02-7031-6101 Warranty service and support: +39-800-820094 (Italian)
Japan	Desktop: Toll free: 0120-887-870 For International: +81-46-266-4724 ThinkPad: Toll free: 0120-887-874 For International: +81-46-266-4724 Both of the above numbers will be answered with a Japanese language voice prompt. For telephone support in English, please wait for the Japanese voice prompt to end, and an operator will answer. Please ask for "English support please," and your call will be transferred to an English speaking operator. PC Software: 0120-558-695 Overseas calls: +81-44-200-8666 (Japanese)
Korea	1588-5801 (Korean)
Latvia	+386-61-1796-699
Lithuania	+386-61-1796-699
Luxembourg	+352-298-977-5063 (French)
Malaysia	1800-88-8558 (English, Bahasa, Melayu)
Malta	+356-23-4175
Mexico	001-866-434-2080 (Spanish)
Middle East	+44 (0)1475-555-055
Netherlands	+31-20-514-5770 (Dutch)
New Zealand	0800-446-149 (English)
Nicaragua	255-6658 (Spanish)
Norway	Up and running support: 6681-1100 Warranty service and support: 8152-1550 (Norwegian)
Panama	206-6047 (Spanish)
Peru	0-800-50-866 (Spanish)
Philippines	1800-1888-1426 +63-2-995-8420 (English, Philipino)

Country or Region	Telephone Number
Poland	+48-22-878-6999
Portugal	+351-21-892-7147 (Portuguese)
Romania	+4-021-224-4015
Russian Federation	+7-095-940-2000 (Russian)
Singapore	1800-3172-888 (English, Bahasa, Melayu)
Slovakia	+421-2-4954-1217
Slovenia	+386-1-4796-699
Spain	91-714-7983 91-397-6503 (Spanish)
Sri Lanka	+94-11-2448-442 (English)
Sweden	Up and running support: 08-477-4420 Warranty service and support: 077-117-1040 (Swedish)
Switzerland	Up and running support: 058-333-0900 Warranty service and support: 0800-55-54-54 (German, French, Italian)
Taiwan	886-2-8723-9799 (Mandarin)
Thailand	1-800-299-229 (Thai)
Turkey	00800-4463-2041 (Turkish)
United Kingdom	Up and running support: 01475-555-055 Warranty service and support (hardware): 08705-500-900 Warranty service and support (software): 08457-151-516 (English)
United States	1-800-426-7378 (English)
Uruguay	000-411-005-6649 (Spanish)
Venezuela	0-800-100-2011 (Spanish)
Vietnam	For northern area and Hanoi: 84-4-8436675 For southern area and Ho Chi Minh City: 84-8-829-5160 (English, Vietnamese)

Appendix B. Notices

Lenovo may not offer the products, services, or features discussed in this document in all countries. Consult your local Lenovo representative for information on the products and services currently available in your area. Any reference to a Lenovo product, program, or service is not intended to state or imply that only that Lenovo product, program, or service may be used. Any functionally equivalent product, program, or service that does not infringe any Lenovo intellectual property right may be used instead. However, it is the user's responsibility to evaluate and verify the operation of any other product, program, or service.

Lenovo may have patents or pending patent applications covering subject matter described in this document. The furnishing of this document does not give you any license to these patents. You can send license inquiries, in writing, to:

*Lenovo (United States), Inc.
500 Park Offices Drive, Hwy. 54
Research Triangle Park, NC 27709
U.S.A.
Attention: Lenovo Director of Licensing*

LENOVO GROUP LTD. PROVIDES THIS PUBLICATION "AS IS" WITHOUT WARRANTY OF ANY KIND, EITHER EXPRESS OR IMPLIED, INCLUDING, BUT NOT LIMITED TO, THE IMPLIED WARRANTIES OF NON-INFRINGEMENT, MERCHANTABILITY OR FITNESS FOR A PARTICULAR PURPOSE. Some jurisdictions do not allow disclaimer of express or implied warranties in certain transactions, therefore, this statement may not apply to you.

This information could include technical inaccuracies or typographical errors. Changes are periodically made to the information herein; these changes will be incorporated in new editions of the publication. Lenovo may make improvements and/or changes in the product(s) and/or the program(s) described in this publication at any time without notice.

The products described in this document are not intended for use in implantation or other life support applications where malfunction may result in injury or death to persons. The information contained in this document does not affect or change Lenovo product specifications or warranties. Nothing in this document shall operate as an express or implied license or indemnity under the intellectual property rights of Lenovo or third parties. All information contained in this document was obtained in specific environments and is presented as an illustration. The result obtained in other operating environments may vary.

Lenovo may use or distribute any of the information you supply in any way it believes appropriate without incurring any obligation to you.

Any references in this publication to non-Lenovo Web sites are provided for convenience only and do not in any manner serve as an endorsement of those Web sites. The materials at those Web sites are not part of the materials for this Lenovo product, and use of those Web sites is at your own risk.

Any performance data contained herein was determined in a controlled environment. Therefore, the result obtained in other operating environments may

vary significantly. Some measurements may have been made on development-level systems and there is no guarantee that these measurements will be the same on generally available systems. Furthermore, some measurements may have been estimated through extrapolation. Actual results may vary. Users of this document should verify the applicable data for their specific environment.

Trademarks

The following terms are trademarks of Lenovo in the United States, other countries, or both:

Lenovo
Lenovo logo

Microsoft, Windows, and Windows NT are trademarks of Microsoft Corporation in the United States, other countries, or both.

Other company, product, or service names may be trademarks or service marks of others.