

KREISEN

ENGLISH

30" WIDE LCD Color TV/MONITOR

Owner's Manual

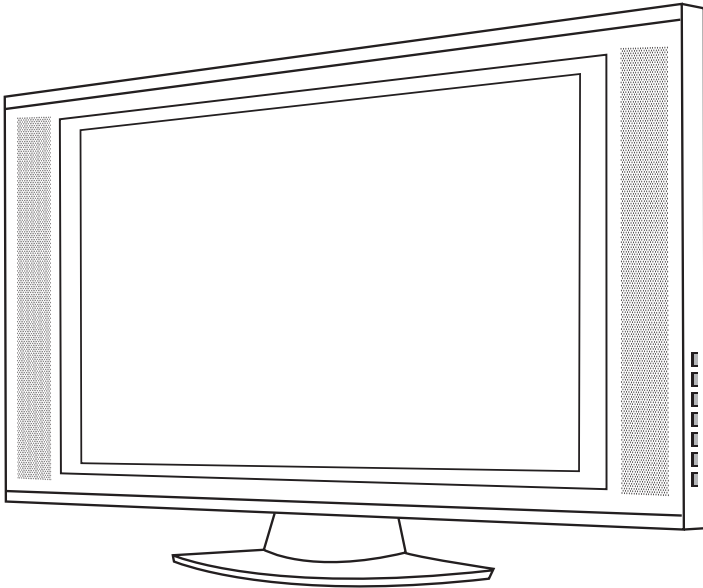

Model: **LT-30FMP**

Warnings



WARNING

RISK OF ELECTRIC SHOCK
DO NOT OPEN.



WARNING :

To reduce the risk of electric shock do not remove cover (or back).
No user serviceable parts inside. Refer servicing to qualified service personnel.



The lightning flash with arrowhead symbol, within an equilateral triangle, is intended to alert the user to the presence of uninsulated “dangerous voltage” within the product’s enclosure that may be of sufficient magnitude to constitute a risk of electric shock to persons..



The exclamation point within an equilateral triangle is intended to alert the user to the presence of important operating and maintenance (servicing) instructions in the literature accompanying the appliance.

TO PREVENT FIRE OR SHOCK HAZARD DO NOT EXPOSE THE SET TO RAIN OR MOISTURE.

NOTE TO CABLE/TV INSTALLER:

This reminder is provided to call the cable TV system installer’s attention to Article 820-40 of the National Electric Code (U.S.A.). The code provides guidelines for proper grounding and, in particular, specifies that the cable ground shall be connected to the grounding system of the building, as close to the point of the cable entry as practical.

REGULATORY INFORMATION:

This equipment has been tested and found to comply with the limits for a Class B DIGITAL device, pursuant to part 15 of the FCC Rules. These limits are designed to provide reasonable protection against harmful interference when the equipment is operated in a residential Installation. This equipment generates, uses and can radiate radio frequency energy and, if Not installed and used in accordance with the instruction manual, may cause harmful interference to radio communications. However, there is no guarantee that interference will not occur in a particular installation. If this equipment does cause harmful interference to radio or television reception, which can be determined by turning the equipment off and on, the user is encouraged to try to correct the interference by one or more of the following measures:

- Reorient or relocate the receiving antenna.
- Increase the separation between the equipment and receiver.
- Connect the equipment into an outlet on a circuit different from that to which the receiver is connected.
- Consult the dealer or an experienced radio/TV technician for help.

CAUTION:

Do not attempt to modify this product in any way without written authorization. Unauthorized modification could void the user’s authority to operate this product.

IMPORTANT SAFETY INSTRUCTIONS

IMPORTANT SAFETY INSTRUCTIONS

Important safeguards for you and your new product

Your product has been manufactured and tested with your safety in mind. However, improper use can result in potential electrical shock or fire hazards. To avoid defeating the safeguards that have been built into your new product, please read and observe the following safety points when installing and using your new product, and save them for future reference.

Observing the simple precautions discussed in this operating guide can help you get many years of enjoyment and safe operation that are built into your new product.

This product complies with all applicable U.S. Federal regulations and voluntary safety standards.

1. Read Instructions

All the safety and operating instructions should be read before the product is operated.

2. Follow Instructions

All operating and use instructions should be followed.

3. Retain Instructions

The safety and operating instructions should be retained for future reference.

4. Heed Warnings

All warnings on the product and in the operating instructions should be adhered to.

5. Cleaning

Unplug this product from the wall outlet before cleaning. Do not use liquid cleaners or aerosol cleaners. Use a damp cloth for cleaning.

6. Water and Moisture

Do not use this product near water for example, near a bathtub, washbowl, kitchen sink, or laundry tub, in a wet basement, or near a swimming pool.

7. Accessories, Carts, and Stands

Do not place this product on a slippery or tilted surface, or on an unstable cart, stand, tripod, bracket, or table. The product may slide or fall, causing serious injury to a child or adult, and serious damage to the product. Use only with a cart, stand, tripod, bracket, or table recommended by the manufacturer, or sold with the product. Any mounting of the product should follow the manufacturer's instructions, and should use a mounting accessory recommended by the manufacturer.

8. Transporting Product

A product and cart combination should be moved with care. Quick stops, excessive force, and uneven surfaces may cause the product and combination to overturn.



4

PORTABLE CART WARNING

9. Attachments

Do not use attachments not recommended by the product manufacturer as they may cause hazards.

10. Ventilation

Slots and openings in the cabinet are provided for ventilation and to ensure reliable operation of the product and to protect it from overheating, and these openings must not be locked or covered. The openings should never be blocked by placing the product on a bed, sofa, rug, or other similar surface. This product should not be placed in a built-in installation such as a bookcase or rack unless proper ventilation is provided or the manufacturer's instructions have been adhered to.

11. Power Sources

This product should be operated only from the type of power source indicated on the marking label. If you are not sure of the type of power supply to your home, consult your product dealer or local power company. For products intended to operate from battery power, or other sources, refer to the operating instructions.

12. Power Cord Polarization

This product is equipped with a three-wire grounding-type plug, a plug having a third (grounding) pin. This plug will only fit into a grounding-type power outlet. This is a safety feature. If you are unable to insert the plug into the outlet, contact your electrician to replace your obsolete outlet. Do not defeat the safety purpose of the grounding-type plug.

13. Power Cord Protection

Power-supply cords should be routed so that they are not likely to be walked on or pinched by items placed upon or against them, paying particular attention to cords at plugs, convenience receptacles, and the point where they exit from the product.

IMPORTANT SAFETY INSTRUCTIONS

14. Outdoor Antenna Grounding

If an outside antenna or cable system is connected to the product, be sure the antenna or cable system is grounded so as to provide some protection against voltage surges and built-up static charges. Article 810 of the National Electrical Code (U.S.A.), ANSI/NFPA 70 provides information with regard to proper grounding of the mast and supporting structure, grounding of the lead-in wire to an antenna discharge unit, size of grounding conductors, location of antenna-discharge unit, connection to grounding electrodes, and requirements for the grounding electrode.

Example of Grounding According to National Electrical Code Instructions

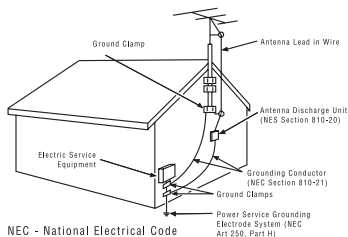

15. Lightning

For added protection for this product (receiver) during a lightning storm, or when it is left unattended and unused for long periods of time, unplug it from the wall outlet and disconnect the antenna or cable system. This will prevent damage to the product due to lightning and power-line surges.

16. Power Lines

An outside antenna system should not be located in the vicinity of overhead power lines or other electric light or power circuits, or where it can fall into such power lines or circuits. When installing an outside antenna system, extreme care should be taken to keep from touching such power lines or circuits, as contact with them might be fatal.

17. Overloading

Do not overload wall outlets and extension cords as this can result in a risk of fire or electric shock.

18. Object and Liquid Entry

Never push objects of any kind into this product through openings as they may touch dangerous voltage points or short-out parts that could result in a fire or electric shock. Never spill liquid of any kind on the product.

19. Servicing

Do not attempt to service this product yourself as opening or removing covers may expose you to dangerous voltage or other hazards. Refer all servicing to qualified service personnel.

20. Damage Requiring Service

Unplug this product from the wall outlet and refer servicing to qualified service personnel under the following conditions:

- If the power-supply cord or plug is damaged.
- If liquid has been spilled, or objects have fallen into the product.
- If the product has been exposed to rain or water.
- If the product does not operate normally by following the operating instructions. Adjust only those controls that are covered by the operating instructions as an improper adjustment of other controls may result in damage and will often require extensive work by a qualified technician to restore the product to its normal operation.
- If the product has been dropped or the cabinet has been damaged.
- If the product exhibits a distinct change in performance.

21. Replacement Parts

When replacement parts are required, be sure the service technician has used replacement parts specified by the manufacturer or have the same characteristics as the original part. Unauthorized substitutions may result in fire, electric shock, or other hazards.

22. Safety Check

Upon completion of any service or repairs to this product, ask the service technician to perform safety checks to determine that the product is in proper operating condition.

23. Wall Mounting

The product should be mounted to a wall only as recommended by the manufacturer. The product may slide or fall, causing serious injury to a child or adult, and serious damage to the product.

24. Heat

The product should be situated away from heat sources such as radiators, heat registers, stoves, or other products (including amplifiers) that produce heat.

Contents

Before operating the set, please read this manual carefully.	
Warnings	3
Important Safety Instructions	4~5
Contents	7
Supplied Accessories	8
Controls	9~11
Channel of panel	9
Remote controller	10~11
Basic Operation	12
On and off	12
Channel selection	12
Volume adjustment	12
Q.View	12
Mute Function	12
On screen Language selection	12
On Screen Menus and Displays	13
Setting up TV Channel	14~16
Auto Program	14
Manual Program	15
Program list	16
Picture Control	17
Manual picture control	17
Auto picture control	17
Sound Control	18
Captions	19
Parental Control	20~22
Other functions	23~24
TV, VIDEO, COMPONENT and S-VIDEO mode	23
Auto sleep	23
Blue Back	23
Auto Wide	23
Sleep timer	24
SAP	24
PIP function	24
External Equipment Connection	25~26
Antenna Connection	25
COMPONENT INPUT	25
A/V INPUT	25
S-VIDEO INPUT	26
DTV INPUT	26
Headphone OUT	26
Sub Woofer OUT	26
Connecting PC as monitor	27~28
Product specifications	29
Troubleshooting	30
Limited Warranty	31

Supplied Accessories

■ Make sure the following accessories are provided with Product.

1. AC/DC adaptor

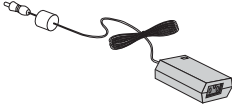

2. AC cord



4. Batteries (2EA)

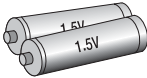

3. Remote controller

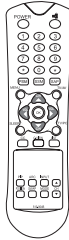

6. PC ANALOG IN cable

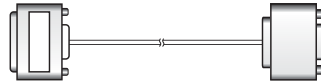

5. Owner's manual

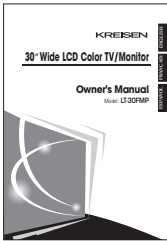

7. PC DIGITAL IN cable



8. PC Audio IN cable



Battery installation

■ Inserting batteries

1. Remove the battery cover by pulling it upward in the direction shown by the arrow.
2. Insert the batteries with correct polarity ("+" to "+", and "-" to "-").
3. Replace the battery compartment cover.

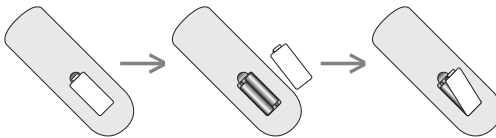

*Install two high-quality 1.5V "AAA" alkaline batteries. Don't mix old batteries with new batteries.

*Remove batteries when you won't use the remote controller for long time. Liquid leakage from old batteries may cause operation failure.

■ Notes for using remote controller

- Make sure there are no objects between the remote controller and its sensor.
- Don't place the remote control near a heater or in damp place. Strong impact to the remote control may cause operation failure.
- Signal from the remote control may be disturbed by sun light or other bright light. In this case, darken the room or move the TV.

Controls

1. ON/OFF Switches TV set on or off.

2. MENU

Displays a menu.

3. + CH - (Channel Up/Down)

Selects a Channel or a menu item.

4. + VOL - (Volume Up/Down)

Adjusts the volume./ Adjusts menu settings.

5. TV/AV Selects TV, VIDEO, COMPONENT, S-VIDEO, PC-ANALOG or PC-DIGITAL or DTV(Option) mode./Clears the menu from the screen.

6. Power Indicator

Illuminates in red when the TV is in standby mode./ Illuminates in green when the TV is switched on. Illuminates in blinking when the power save mode(only PC mode).

7. Remote control sensor

Accepts the IR signal of remote controller.

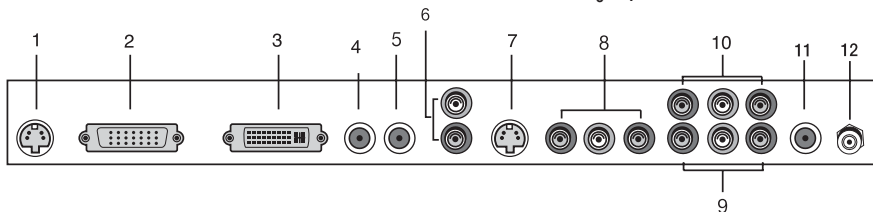
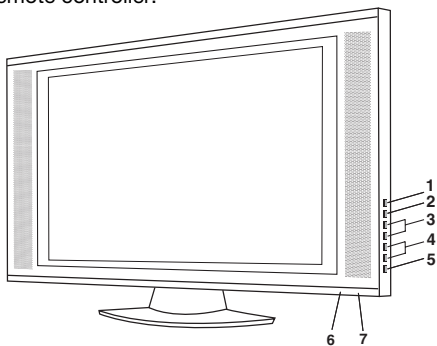

1. DC 24V adaptor input

2. PC ANALOG (D-SUB)

3. PC DIGITAL (DVI-I)

4. PC Audio IN

Connect the audio cable from the PC to the **PC Audio IN** of the set.

5. HEADPHONE out

Connect a headphone to this socket.

6. AUDIO IN[L(MONO)/R]

Connect the audio (L, R) output of S-VIDEO and COMPONENT.

7. S-VIDEO input

8. COMPONENT (DVD/DTV)

9. AV-IN

10. AV-OUT

11. Sub Woofer OUT

12. Ant. (Antenna input)

Controls

All the functions can be controlled with the remote controller. Some functions can also be adjusted with the buttons on the front panel of the set.

Remote controller

Before you use the remote controller, please install the batteries.

1. POWER

Turns the TV on from standby or off to standby mode.

2. MUTE

Turns the sound on and off.

3. NUMBER buttons

Selects Channel numbers.

4. PSM (Picture Status Memory)

Recalls your preferred picture setting

5. SSM (Sound Status Memory)

Recalls your preferred sound setting

6. SAP

Adjusts the MTS-stereo, Mono, SAP

7. MENU

Displays a main menu.

8. TV/AV

Selects TV, VIDEO, COMPONENT, S-VIDEO, PC-ANALOG, PC-DIGITAL or DTV mode.

Clears the menu from the screen.

9. SLEEP

Sets the sleep timer.

10. TV/PC

Selects TV , PC-ANALOG or PC-DIGITAL, DTV mode directly.

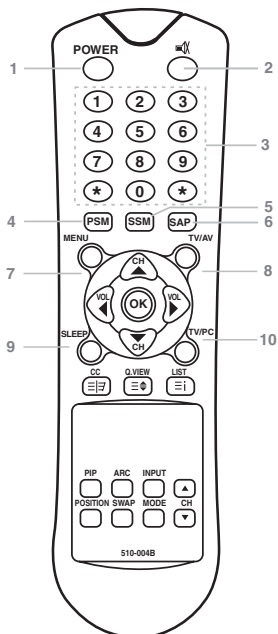

Controls

11. CH▲▼ (Channel Up/Down)

Selects next Channel or a menu item.

12. VOL◀▶ (Volume Up/Down)

Adjusts the sound level.

Adjusts menu settings.

13. OK

Accepts your selection or displays the current mode.

14. CC

Set the caption function.

15. Q.VIEW

Returns to the previously viewed Channel.

16. LIST

Displays the program list menu.

17. PIP

Displays a PIP(Picture In Picture) screen.

18. ARC

Selects a screen mode- 16:9, 14:9, ZOOM,1:1, 4:3.

19. INPUT

Selects the AV source of sub picture in PIP mode.

20. POSITION

Selects a position of PIP screen.

21. SWAP

Switches a main picture for sub picture in PIP mode.

22. MODE

Selects a PIP screen mode. – 16:1, 9:1, double window and scan mode.
It's possible when a main mode is video mode.

23. ▲CH▼

Selects a Channel when RF signal is displayed in PIP mode.

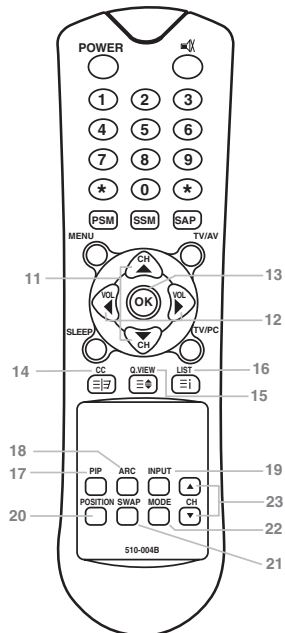

Basic Operation

Turning the TV On and Off

Standby Setup: The AC-DC converter and the AC power cord must be set up and connected to have the TV in standby mode ready to be turned on. Press the power button on the front panel of the TV to go into standby mode.

1. If the TV is in standby mode, press the Power button on the remote controller or the TV itself to turn the TV on.
2. Press the Power button again on the remote controller or the TV itself to turn the TV off.

Note : If the TV is on and the power button is pressed to turn the TV off, the TV goes into standby mode.

Channel selection

You can select a Channel number with the CH▲▼ button or NUMBER buttons.

Volume adjustment

Press the VOL◀▶ button to adjust the sound level.

Quick view

Press the Q.VIEW button to view the last channel you were watching.

Sound mute function

Press the MUTE button. The sound is switched off and the mute display  appears.

To cancel mute mode, press the MUTE button again, VOL◀▶, SSM button or SAP button.

On screen menu language selection

The menu can be displayed on the screen in desired language.

First select your language.

1. Press the MENU button.
2. Select the Setup menu.
3. Select the Language.
4. Press the CH▲▼ button to select your desired language.
5. Press the TV/AV button.

All the on screen menu will appear in the selected language.

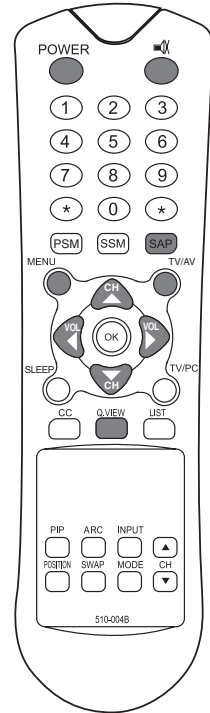

On Screen Menus and Display

1. Press the **MENU** button to display main menu.
2. Press the **CH▲▼** button to select menus-Picture, Sound, Special, Setup.
3. Adjust each menu with the **VOL◀▶** button.
4. Press the **MENU** button to return to preceding menu.
5. Press the **TV/AV** button to finish adjusting menu.

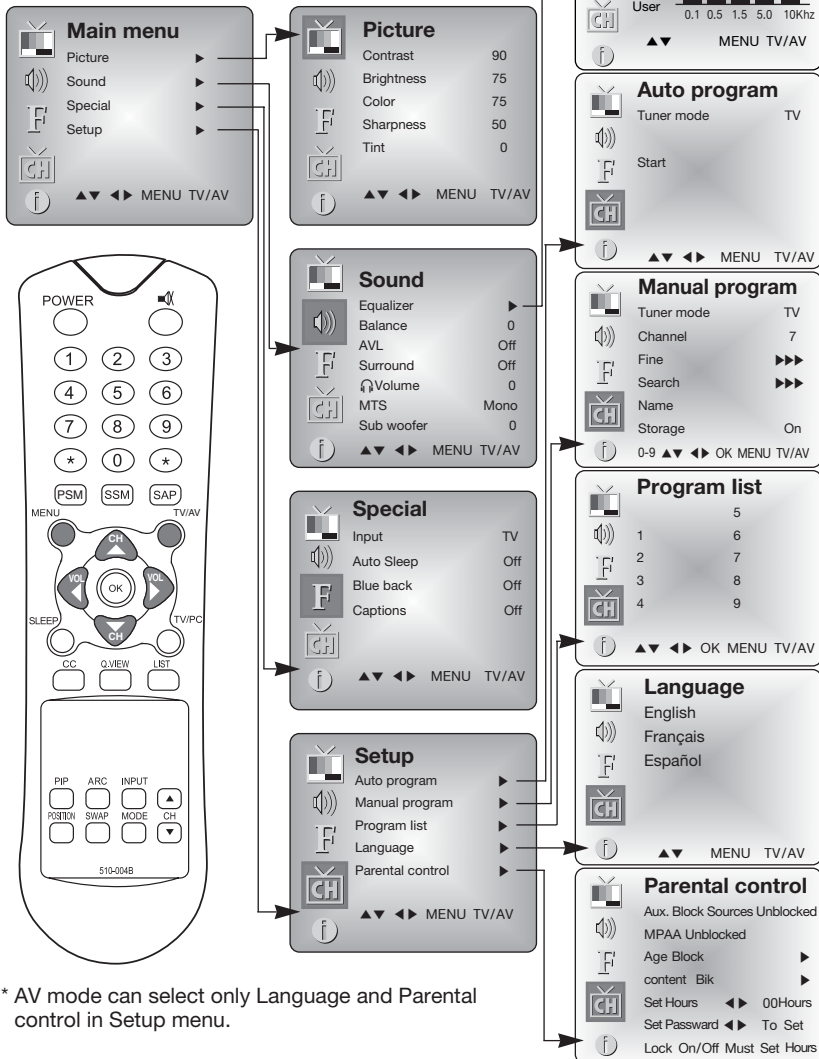

* AV mode can select only Language and Parental control in Setup menu.

Setting up TV Channel

Once you have preset the Channel, you will be able to use the **CH▲▼** to scan the Channel you Programmed. Channel can be tuned using Auto or Manual Program menu.

Auto Program

All Channel that can be received are stored by this method. It is recommended that you use Auto Program during installation of this set.

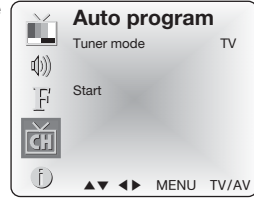

1. Press the **MENU** button.
2. Select the **Setup** menu.
3. Select the **Auto program** menu.
4. Press the **CH▲▼** button to select **Tuner mode**.
5. Select a Tuner mode with the **VOL◀▶** button.
TV ◀▶Cable
6. Select the **Start** with the **CH▲▼** button.
7. Press the **VOL◀▶** button to start **Auto program**.
8. Press the **MENU** button to stop Auto Program.
9. Press the **TV/AV** button to return to normal TV viewing.

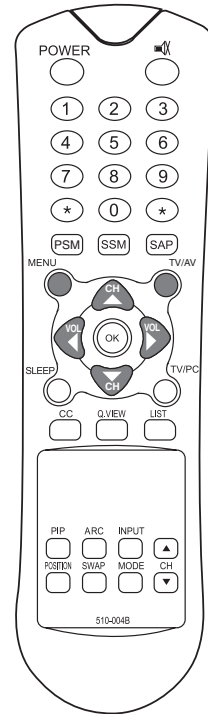

Setting up TV Channel

Manual Program

Manual Program lets you manually tune and arrange the Channels in whatever order you desire. Also you can assign a Channel name with 5 characters to each Channel number.

1. Press the **MENU** button.
2. Select the **Setup** menu.
3. Select **Manual program** menu.
4. Press the **CH▲▼** button to select **Tuner mode**.
TV ◀▶ Cable
6. Press the **CH▲▼** button to select **Channel**.
7. Select the Fine menu and adjust the received signal with **VOL◀▶** button.
8. Press the **CH▲▼** button to select Search. Press the **NUMBER** buttons to commence searching.
9. Press the **CH▲▼** button to select Name.
Press the **VOL◀▶** button. You can use a blank +, -, the numeric 0 to 9, and the alphabet A to Z. With the **VOL◀▶** button, you can select in the opposite direction.
10. If this Channel is the one required, press the **CH▲▼** button to select Storage. Press the **VOL◀▶** button twice to select **On**.
To select another channel, repeat steps 5 to 10.

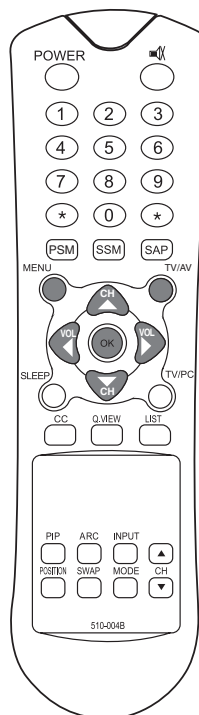
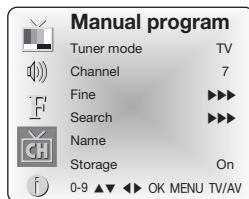

Setting up TV Channel

Program list

You can check the Programs stored in the memory by displaying the Program list.

1. Press the **MENU** button.
2. Select the **Setup** menu.
3. Press the **CH▲▼** button select **Program list**.

Selecting a Channel in the Program list

Select a Channel with the **CH▲▼** or **VOL◀▶** button. The set switches to the chosen Channel number.

Paging through a Program list

When The set is TV mode, there are 7 program table pages in which contain 69 programs and when the set is cable mode, there are 13 program table pages in which contain 125 programs.

Pressing the **CH▲▼** or **VOL◀▶** button repeatedly turns the pages.

The channel which is a signal is indicated with a white color. The channel which is a no signal is indicated with a blue color.

And the channel which searches a signal is indicated with a yellow color.

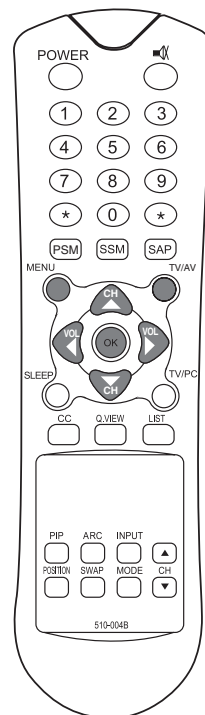

Picture Control

You can adjust picture Contrast, Brightness, Color, Sharpness and Tint to the levels you prefer.

Manual Picture Control

1. Press the **MENU** button.
2. Select the Picture.
3. Press the **CH▲▼** buttons to select a picture item.
4. Press the **VOL◀▶** buttons to adjust the picture condition as you want.
5. Press the **TV/AV** button to store for the picture User.

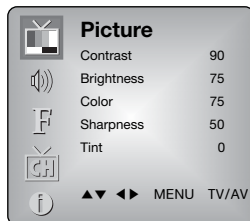

Selected Item	Setting Change
Contrast	More darkness VOL◀ 0~100 ▶VOL More light
Brightness	Less bright VOL◀ 0~100 ▶VOL More bright
Color	Lower color intensity VOL◀ 0~100 ▶VOL Higher color intensity
Sharpness	Soft picture VOL◀ 0~100 ▶VOL Hard picture
Tint	More purple VOL◀ 50~50 ▶VOL More green

Auto Picture Control

PSM (Picture Status Memory)

1. Press the **PSM** button.
 2. Press the **PSM** button repeatedly to select [PSM].
- Each press of the button changes the screen display as below.

Dynamic → **Standard** → **Mild** → **Game** → **User**



- **Dynamic** : Vivid Picture Appearance
- **Standard** : Standard Picture Appearance
- **Mild** : Softer Picture Appearance
- **Game** : External Video Game Picture Setup
- **User** : Manual Picture Setup

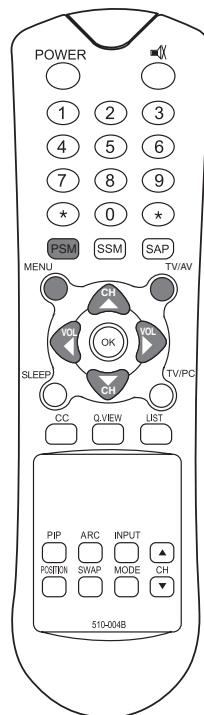

Sound Control

You can select your preferred sound setting; Flat, Music, Movie or Speech and you can also adjust the sound frequency of equalizer, balance. If you switch AVL to on, the set automatically keeps on an equal volume level even if you change program.

1. Press the **MENU** button.
2. Select the **Sound** menu.
3. Press the **CH▲▼** button to select the desired sound item; **Equalizer**, **Balance**, **AVL**, **Surround** or **Volume**, **MTS**.
4. Press the **VOL◀▶** button to make desired adjustment.
5. Press the **VOL◀▶** button in **Equalizer** to set the **Equalizer**.

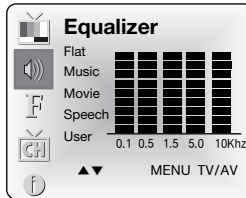
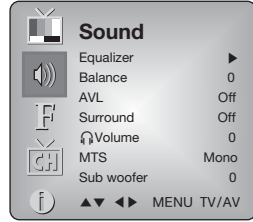

6. Press the **CH▲▼** button to select your preferred setting ; **Flat**, **Music**, **Movie**, **Speech** or **User**.
To set the **Equalizer User**.
 - a. Select **User** by pressing the **CH▲▼** button.
 - b. Select a sound band by pressing the **VOL◀▶** button.
 - c. Make appropriate sound level with the **CH▲▼** button.
 - d. Press the **MENU** button to return to preceding MENU and the **TV/AV** button to return to normal TV viewing.
7. Select the Balance menu and adjust the balance of speakers.
8. Select the **AVL**(Automatic Volume Leveler) menu On or Off
9. Select the **Surround** menu On or Off.
10. Select the **Volume** menu and adjust the volume from headphone.
11. Press the **SAP** button to select the desired sound item.
Each time you press the **SAP** buttons, the **MTS** is displayed one by one as shown below.

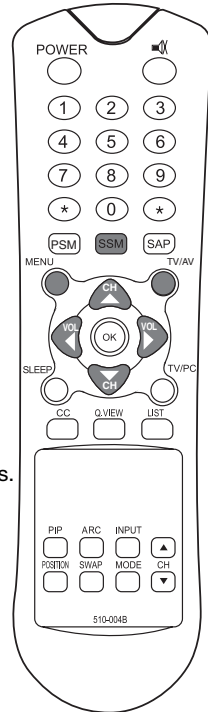

Auto Sound Control

SSM (Sound Status Memory)

1. Press the **SSM** button.
 2. Press the **SSM** button repeatedly to select.
- Each press of the button changes the screen display as below.

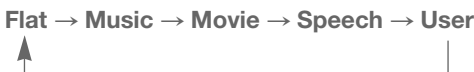

Captions

Closed captioning is a process, which converts the audio portion of a television program into written words, which then appear on the television screen in a form similar to subtitles. Closed captions allow viewers to read the dialogue and narration of television programs.

Using Closed Captions

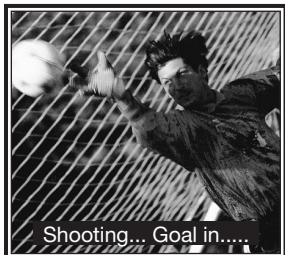

Captions are the subtitles of the dialogue and narration of television programs. For prerecorded programs, program dialogue can be arranged into captions in advance. It's possible to caption a live program by using a process called real-time captioning, which creates captions instantly. Professional reporters using a machine shorthand system and computer for translation into English normally do real-time captioning.

Captioning is an effective system for the hearing-impaired, and it can also aid in teaching language skills.

The picture at left shows a typical caption.

Poor reception conditions are encountered:

- **IGNITION:**

Picture may flutter, drift, and suffer from black spots or horizontal streaking. Usually caused by interference from automobile ignition systems, neon lamps, electrical drills, and other electrical appliances.

- **GHOSTS:**

Ghosts are caused when the TV signal splits and follows two paths. One is the direct path and the other is reflected off tall buildings, hills or other objects. Changing the direction or position of the antenna may improve reception.

- **SNOW:**

If your receiver is located at the weak, fringe area of a TV signal, your picture may be marred by small dots. It may be necessary to install a special antenna to improve the picture.

An old, bad, or illegally recorded tape is played.

Strong, random signals from a car or airplane interference with the TV signal.

The signal from the antenna is weak.

The program wasn't captioned when it was produced, transmitted or taped.

1. Press the **MENU** button.
2. Select the the **Special** menu
3. Press the **CH** ▲▼ buttons to select Caption menu.
4. Press the **VOL** ◀▶ button, select the Caption mode.
5. Each time you press the **VOL** ◀▶ buttons, the caption mode is displayed one by one as shown below.

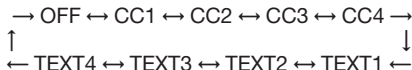

6. Press the **TV/AV** button

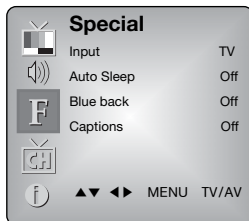

* This TV is programmed to remember which mode it was last set to, even if you switch the POWER off.

* To convert as below needs about 10 seconds. (Because time to read information for conversion is quite long in contrast with the others.)

CC4 ↔ TEXT1 ↔ TEXT2

Parental Control

If used, this optional feature can “block” undesirable programming from appearing on the TV. Note: Parental Control is not available in PC Mode. To block Computer inputs, use the block AUX SOURCES option in the Parental Control menu in TV Mode; computer inputs will not be available.

Parental Control offers the user a wide variety of options and settings that restrict or “block” the programming that can appear on the TV. Parental control allows the user the capability of defining which program rating they consider acceptable, to the younger or more sensitive viewer. It can be preset and turned either on or off by the user who specifies the secret 4-number code, the password. The number of hours blocked are specified. General audience and children viewer blocks should both be programmed into the TV’s memory. Viewer ratings are specified for both TV and the motion picture industry; both rating systems should be used, for complete coverage. The ratings are based on the ages of children.

Overview

To insure complete coverage for all TV programs, (movies and regular TV shows) choose a rating for MPAA, from the selections below. AND choose ratings from the TV Parental Guidelines Rating System on the next page, using the Age Block option for General Audiences, and for Children. In addition to those, you may wish to add additional restrictions from the Content Block menu. See the Parental Control menu, and submenus example on the next page.

Things to Consider before Setting Up Parental Control

Determine which rating you consider acceptable to the viewer. (For example, if you choose TV-PG, all more restrictive ratings will be automatically blocked; the viewer will not be able to see: TV-PG, TV-14, or TV-MA rated programming.)

Do you want to block the auxiliary video source entirely? (Blocks the signal sent by the equipment, such as a VCR, connected to the TV Audio/Video input jacks; in the Aux. Block option.) Or leave unblocked, then choose allowable ratings.

Block program “Content” based on individual parameters such as: Strong Dialog, Bad Language, Sex Scenes, Violence Scenes, or Fantasy Violence Scenes; in the Content Blk option.

How many hours do you want Parental Control to be active? You can set the Hours option for up to 99 hours.

Select a secret password; in the Set Password option. Use the number keys on the remote. Don’t forget the password, it is the only way you can access the Parental Control menu and change rating selections, or turn Parental Control off.

Do you want Parental Control to be active all the time? If not, you can turn it on or off with the Lock On/Off option.

- * You can set different Parental Control viewing restrictions for general audiences and for children - - both can be active at the same time.
- * Simply specifying one content block such as Sex Scenes, will not automatically block another content in the programs from appearing.
- * Even if you choose to leave the Aux inputs unblocked, the ratings you specify will automatically restrict the programming that appears from the video sources.
- * You cannot disable Parental Control by disconnecting the TV from power. Block hours will automatically reset to the original block time setting specified if power is disconnected.

Parental Control

1. Press the **MENU** button.
2. Select the **Setup** menu
3. Select the Parental Control.
4. Press the **CH▲▼** button to select.
5. Adjust each item with **VOL◀▶** button

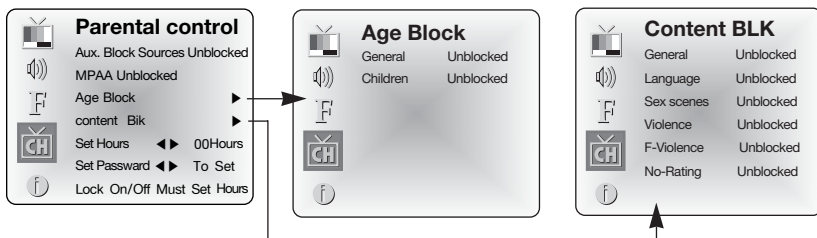

Parental Control	
Selected Item	Setting Change
Aux. Block Source	Unlocked↔Blocked
MPAA	Unlocked↔G and Above↔PG and Above↔PG-13 and Above↔R and Above↔NC-17 and Above↔X
Set Hours	00~99 hours
Lock On/Off	On↔Off
Age Block	
General	Unlocked↔TV-G and Above↔TV-PG and Above↔TV-14 and Above↔TV-MA
Children	Unlocked↔TV-Y and Above↔TV-Y7
Content Block	
Dialog	Unlocked↔TV-PG and Above↔TV-14
Language	Unlocked↔TV-PG and Above↔TV-14 and Above↔TV-MA
Sex Scenes	Unlocked↔TV-PG and Above↔TV-14 and Above↔TV-MA
Violence	Unlocked↔TV-PG and Above↔TV-14 and Above↔TV-MA
F- Violence	Unlocked↔TV-Y7
No-Rating	Unlocked↔Blocked

- As shown above, with the Parental Control menu on-screen, use the UP arrow to highlight an option like Content Block, then press the Right arrow.
- Use the Up/Left/Right arrows to select and adjust or set the rating for an option. For Sex Scenes for example, use the “From TV-PG” setting. (See the Mini Glossary, Ratings Charts on this and the previous page for rating definitions.)
- After you have selected and adjusted the parental control menu options to your preferences:
 - Set the hours you want Parental Control active.
 - Set a 4-number password.
 - Set the Lock On/Off option to either on or off.

* When the Parental Control menu is Lock On, PIP picture is scrambled.

Parental Control

INFORMATION

MOTION PICTURE ASSOCIATION OF USA (MPAA) RATING SYSTEM

	Grade	Meaning
G	General Audiences	Content not offensive to most viewers
PG	Parental Guidance Suggested	Content is such that parents may not want their children to view the program.
PG-13	Parental Guidance Suggested	Program is inappropriate for preteens, with a greater degree of offensive material Suggested than a PG rated program
R	Restricted viewing	Not for children under age 17. Strong elements of sex and/or violence.
NC-17	Restricted Viewing	Not for children under age 17 under any circumstances. Strong sexual content.
X	Hard Core Films	Same as NC-17 rating.

TV PARENTAL GUIDELINE RATING SYSTEM

	Grade	Meaning
TV-G	General Audience	Considered suitable for all audiences; children may watch unattended.
TV-PG	Parental Guidance	Suggested Unsuitable for younger children, may contain: Suggestive Dialog, Bad Language, Sex, and Violence Scenes
TV-14	Parents Strongly Cautioned	Unsuitable for children under 14, may contain: Strong Dialog, Bad Language, Sex, and Violence Scenes.
TV-MA	Mature Audience Only	Adults only, may contain: Strong Dialog, Bad Language, Sex, and Violence Scenes.

CHILDREN'S CLASSIFICATIONS

	Grade	Meaning
TV-Y	Children	Considered suitable for all children under 7 years old.
TV-Y7	Children 7 and over	Considered suitable for children over 7, may contain Fantasy Violence Scenes.

Other functions

TV, VIDEO, COMPONENT, and S-VIDEO modes

(You can't set PC ANALOG and PC DIGITAL mode in this menu. Use the TV/AV button)

Inputs can be set for TV, VIDEO, COMPONENT or S-VIDEO mode. VIDEO mode is used when a Video Cassette Recorder (VCR), or other equipment is connected to the set.

Note: When a VCR is connected to the aerial socket the set is used in TV mode. See the 'Connection of external equipment' section.

1. Press the **MENU** button.
2. Select the Special menu.
3. Press the **CH ▲▼** button to select Input.
4. Press the **VOL ◀▶** button to select **TV, VIDEO, COMPONENT and S-VIDEO**.

VIDEO: VIDEO OUT connected to the VIDEO socket of the set.

COMPONENT: COMPONENT connected to the COMPO-NENT INPUT socket of the set.

S-VIDEO: S-VIDEO VCR connected to the S-VIDEO sockets of the set.

Alternatively you can select the **TV, VIDEO, COMPONENT, S-VIDEO, PC ANALOG** and **PC DIGITAL, DTV** modes by pressing the **TV/AV** button.

PC ANALOG: PC connected to the D-SUB in of the set.

PC DIGITAL: PC connected to the DVI in of the set.

DTV: DTV Set Top Box connected to the COMPONENT IN of the set.

Auto sleep

If you select **Auto sleep** on the set will automatically switch itself to standby mode approximately ten minutes after a TV Channel stops broadcasting.

1. Press the **MENU** button, select the Special menu.
2. Press the **CH ▲▼** button to select **Auto sleep**.
3. Press the **VOL ◀▶** button to select On.
4. Press the **TV/AV** button to return to normal TV viewing.

Blue back

Channel without signal appear in blue.

Auto wide (Aspect Ratio Control)

Press the ARC button to select a desired picture format.

Each press of the ARC button, selects Auto Wide, 16:9, 14:9, ZOOM, 1:1 and Auto wide mode.

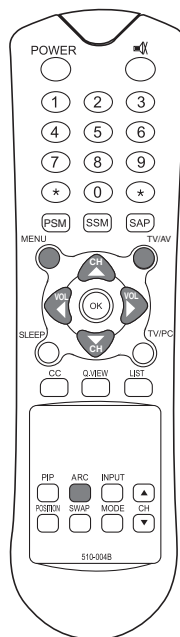

Other functions

Sleep timer

You don't have to remember to switch the set off before you go to sleep. The sleep timer automatically switches the set to standby after the preset time elapses.

Press the **SLEEP** button to select the number of minutes. The display will appear on the screen, followed by **0, 10, 20, 30, 60, 90, 120, 180 and 240**. The timer begins to count down from the number of minutes selected.

Note:

- To view the remaining sleep time, press the **SLEEP** button once.
- To cancel the sleep time, Select 0 with the **SLEEP** button.



SAP

Press the SAP button.

You can select the Sound output system-Stereo, Mono and SAP and the language during dual language broadcast.

PIP Function

Viewing the PIP picture

Press the **PIP** button. (Press the PIP button again, to turn off PIP.)

Selecting the PIP picture mode

Press the **MODE** button to adjust the PIP picture mode. Each press the **MODE** button, selects the 16:1, 9:1, double window and multi picture mode. (Multi picture mode is just available when the main picture is in AV mode.)

Moving the PIP picture

Press the **POSITION** button to adjust the position of sub picture in PIP mode.

Switching the main and PIP picture

Press the **SWAP** button to switch the main and sub picture in PIP mode.

Viewing the external source input

Press the **INPUT** button to select the input source of sub picture in PIP mode.

Press the **CH ▲▼** button to select the Channel desired in TV mode of sub picture.

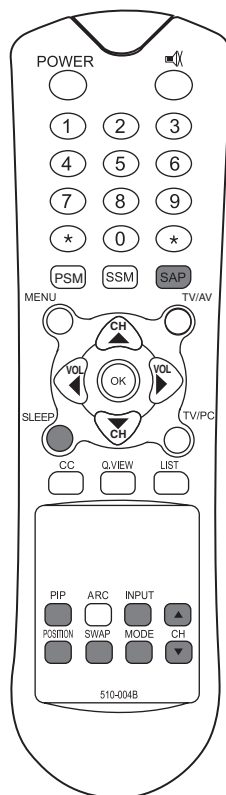

External Equipment Connection

You can connect additional equipment, such as VCRs, camcorders etc. to your set. Examples are shown below.

Antenna connection.

1. Connect RF out on the VCR to the Antenna input on the rear of the TV
2. Connect the antenna cable to the antenna in jack on the VCR.
3. Use the TV/AV button to select TV mode.
4. Press the PLAY button on the VCR.

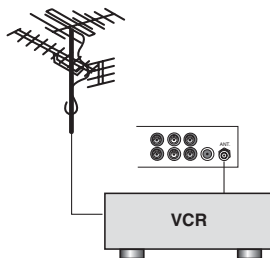

COMPONENT INPUT

1. Connect the COMPONENT video output sockets (Y Cb Cr) of the COMPONENT to the COMPONENT INPUT sockets of the set.
2. Connect the audio cable from the COMPONENT to the COMPONENT INPUT sockets of the set.
3. Press the TV/AV button to select COMPONENT mode.
4. Press the PLAY button on the DVD. The COMPONENT playback picture appears on the screen.

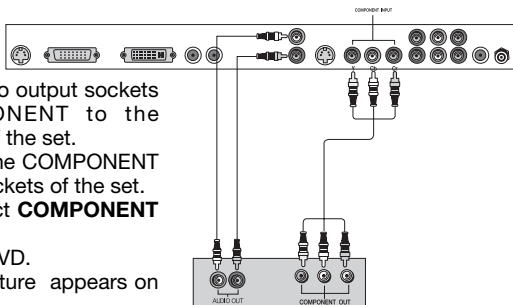

AV INPUT

1. Connect the AV out jacks on of the VCR to AV-In jacks on the TV.
2. Press the TV/AV button to select VIDEO mode.
3. Press the PLAY button on the VCR. The VCR playback picture appears on the screen.

Note : If you have a mono VCR, connect the audio cable from the VCR to the **L(MONO)** socket of the set.

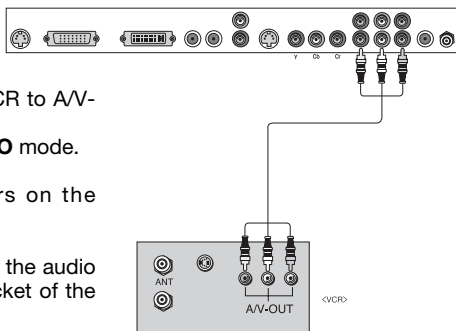

External Equipment Connection

S-VIDEO Input

If using an **S-VIDEO** source, the picture quality will be improved over a video source.

1. Connect the S-VIDEO output of a VCR to the **S-VIDEO** input on the TV.
2. Connect the audio cables from the S-VIDEO VCR to the **L (MONO) R** inputs on the TV.
3. Select **S-VIDEO** mode by pressing the **TV/AV** button repeatedly.
4. Press the **PLAY** button on the VCR.
The VCR playback picture appears on the screen.

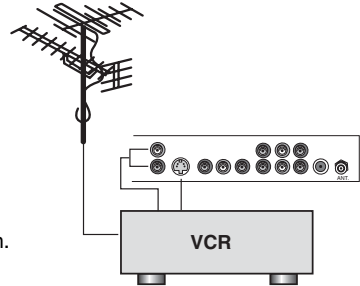

DTV Input

1. Connect the DTV video output sockets (Y, Pb, Pr) of the DTV set top box to the **COMPONENT** Input sockets of the set.
2. Connect the audio cable from the DTV set top box to the Audio Input sockets of the set.
3. Press the **TV/AV** button to select DTV mode.

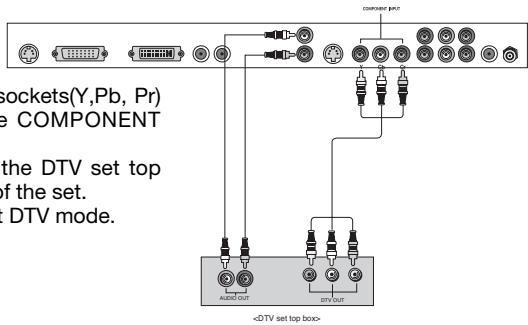

Headphone jack

Insert the headphone plug to the headphone jack on the TV. You can listen to the sound through the headphone; no sound from the speaker on the TV. To adjust the headphone volume, use the Volume menu in the Sound menu.

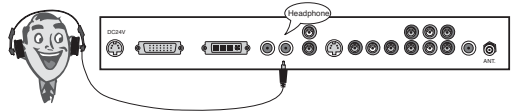

Sub woofer Out

Connect the cable of the sub woofer to the sub woofer output on the TV. You can listen to the bass well. To adjust the bass volume, use the Sub woofer menu in the sound menu.

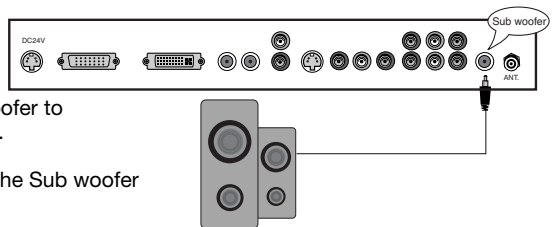

Connecting PC as monitor

Picture adjustment

You can adjust picture Contrast, Brightness, Horizontal/Vertical position, Clock, Phase, Auto and Reset as you prefer.

1. Press the **TV/AV** or **TV/PC** button to select the PC mode.
2. Press the **MENU** button.
3. Press the **CH▲▼** button to select the desired picture item.
4. Press the **VOL◀▶** button to make appropriate adjustments.

Contrast

This function is to adjust picture to light/dark.

Brightness

This function is to adjust brightness of picture.

Temperature

Temperature is a measure of the warmth of the image color.

Horizontal Position/Vertical Position

This function is to adjust picture to left/right and up/down as you prefer.

Clock

This function is to minimize any vertical bars or stripes visible on the screen background. And the horizontal screen size will also change.

Phase

This function allows you to remove any horizontal noise and clear or sharpen the image of characters.

Auto

This function is for the automatic adjustment of the screen position, clock and clock phase. The displayed image will disappear for a few seconds while the Auto-configuration is in process

Note Some signal from some graphics boards may not function properly. If the results are unsatisfactory, adjust our monitor's position, clock and clock phase manually.

Reset

This function allows you to return to the good picture reproduction Programmed at the factory and cannot be changed.

Color

This function is to adjust intensity of the color.

- When DVI source is connected, Auto, Clock and Phase don't operate.
- When DTV source is connected, you can adjust picture Contrast, Brightness, Color, Temperature, Horizontal Position/Vertical Position, Clock, Phase and Reset as you prefer.

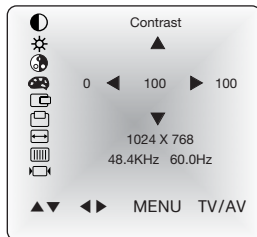
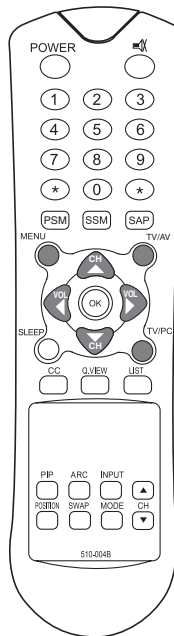
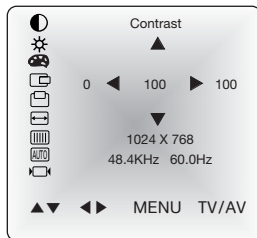

<The Picture adjustment of DTV mode>

Connecting PC as monitor

PC ANALOG(D-SUB) INPUT

1. Connect the PC ANALOG IN cable (D sub jack) from the monitor output socket of the PC to the PC/DTV input socket of the set.
2. Connect the PC Audio IN cable from the PC to the PC Audio IN of the set.
3. Press the **TV/AV** or **TV/PC** button to select **PC ANALOG IN** mode.
4. Switch on the PC, and the PC screen appears on the set.
The set can be operated as the PC monitor.

PC DIGITAL(DVI) INPUT

1. Connect the DVI of PC to the **DVI** input on the TV.
2. Select **PC-DIGITAL** mode by pressing the **TV/AV** button repeatedly.

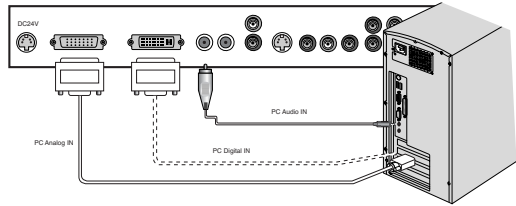

Resolution

Mode	Resolution	Horizontal frequency (KHz)	Vertical frequency (Hz)
VGA	640X480	31.5 KHz	60 Hz
	640X480	35 KHz	67 Hz
	640X480	37.9 KHz	72 Hz
	640X480	37.5 KHz	75 Hz
	720X400	31.5 KHz	70 Hz
SVGA	800X600	35.2 KHz	56 Hz
	800X600	37.9 KHz	60 Hz
	800X600	48.1 KHz	72 Hz
	800X600	46.9 KHz	75 Hz
XGA	1024X768	48.4 KHz	60 Hz
	1024X768	56.5 KHz	70 Hz
	1024X768	60.2 KHz	75 Hz
WXGA	1280X768	47.7 KHz	60 Hz

Note:

- a. If possible, use the VESA 1,024x768@60Hz video mode to obtain the best image quality for your LCD monitor. If used under the other resolutions, some scaled or processed pictures may appear on the screen. The set has been preadjusted to the mode VESA 1,024x 768 @60Hz.
- b. Some dot defects may appear on the screen, like Red, Green or Blue spots. However, this will have no impact or effect on the monitor performance.

Product Spec.

Model	LT-30 FMP			
Main body	Horizontal size	850 mm	Thickness	210 mm
	Height	485 mm	Weight	15 kg
Power requirements	DC 24V/6.0A			
Television system	NTSC			
Television program	VHF: 2~13 UHF: 14~69 Cable: 01~125			
LCD PANEL	30" WIDE TFT LCD panel			
Resolution	WXGA(1280 X 768)			
Power consumption	MAX. 130W			
External antenna impedance	75Ω			
Audio output	10W + 10W			
External IN/OUT ports	<ul style="list-style-type: none"> • DVI 1 • S-VIDEO IN 1 • HEADPHONE JACK 1 • PC IN 1 • PC AUDIO IN 1 • COMPONENT 1 • POWER IN 1 • ANTENNA IN 1 • SUB WOOFER OUT 1 			
AC Power Adaptor	AC 100-240V, 50/60Hz 24Vdc, 6.0A			

Troubleshooting

Problem	Check item
No picture on screen and no sound from speakers.	<ul style="list-style-type: none"> • Insert the AC power cord plug securely in AC power outlet. • Make sure the remote control is not in the standby mode (The POWER/Standby indicator is red.)
No picture/No picture from AV terminal.	<ul style="list-style-type: none"> • Check the brightness setting of the display. • Lamp may have malfunction. • Make sure a cable with no VIDEO input signal is connected to the S-VIDEO INPUT terminal.
Picture is displayed, but no sound from the speakers.	<ul style="list-style-type: none"> • Check the sound setting. • Make sure the sound is not muted. • Make sure the connectors of the optional speaker system are securely inserted. • Make sure the setting of AV OUTPUT terminal
Picture is too light	<ul style="list-style-type: none"> • Make sure COLOR and CONTRAST settings.
Picture is too dark.	<ul style="list-style-type: none"> • Make sure BRIGHTNESS setting is not set too low. • Check to see if BRIGHTNESS setting • Lamp may have malfunction.
Remote control does not work.	<ul style="list-style-type: none"> • Change the batteries. • Make sure the infrared transmitter window is not receiving strong light such as light from fluorescent lamps.
The picture is not sharp. The picture moves.	<ul style="list-style-type: none"> • The reception may be weak. • The state of the broadcast may also be bad. • Make sure the antenna is facing the right direction. • Make sure the outside antenna is not disconnected.
The picture is doubled or tripled.	<ul style="list-style-type: none"> • Make sure the antenna is facing the right direction. • There may be reflected electric waves from mountains or buildings.
The picture is spotted.	<ul style="list-style-type: none"> • There may be interference from automobiles, trains, high voltage lines, neon lights, etc. • There may be interference between the antenna cable and power cable. Try positioning them further apart.
There are stripes on the screen or colors fade.	<ul style="list-style-type: none"> • Is the unit receiving interference from other devices? Transmission antennas of radio broadcasting stations and transmission antennas of amateur radios and cellular phones may also cause interference. • Use the unit as far apart as possible from devices that may cause possible interference.

LIMITED WARRANTY
