

**APEX**

TV/DVD COMBO

**GT2015DV**

---

OPERATION MANUAL

Read this manual carefully before operation.

## BEFORE OPERATION

### Dear Customer:

Congratulations! You have purchased one of the finest TV/DVD combos on the market! This manual will help you use the many exciting and useful features to make your unit viewing more enjoyable than ever before. Before operating your unit, please read all these safety and operating instructions completely and then retain for future reference.

### Customer's Record

You will find the model number and chassis number on the back of your unit. Record these numbers in the spaces provided below. Refer to them whenever you call upon your Apex dealer regarding this product.

Model Number: GT2015DV

Chassis Number: CN-12C2

## Safety Precautions

### WARNING:

TO REDUCE THE RISK OF FIRE OR ELECTRIC SHOCK, DO NOT EXPOSE THIS APPLIANCE TO RAIN OR MOISTURE.

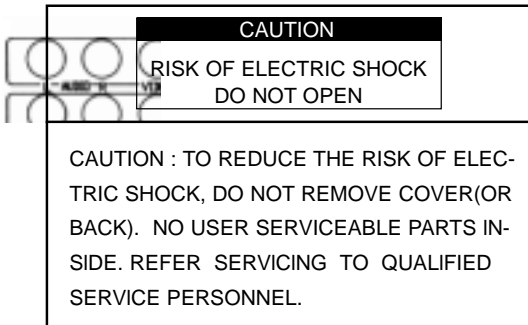

The lightning symbol in the triangle tells you that the voltage inside this product may be strong enough to cause an electric shock.

NOT TRY TO SERVICE THIS PRODUCT YOURSELF.

The exclamation point in the triangle tells you that important operating and maintenance instructions follow this symbol.

### CAUTIONS:

TO PREVENT ELECTRIC SHOCK, DO NOT USE THIS POLARIZED PLUG WITH AN EXTENSION CORD RECEPTACLE OR OTHER OUTLET UNLESS THE PRONGS CAN BE FULLY INSERTED INTO THE OUTLET TO PREVENT ANY EXPOSURE OF THE PRONGS ON THE POLARIZED PLUG.

USE OF CONTROLS OR ADJUSTMENTS OR PERFORMANCE OF PROCEDURES OTHER THAN THOSE SPECIFIED HEREIN MAY RESULT IN HAZARDOUS RADIATION EXPOSURE. **DO NOT STARE INTO BEAM.**

The unit employs a Laser System. To prevent direct exposure to the laser beam, do not try to open the enclosure. Visible laser radiation when open and interlocks defeated.

Avoid displaying stationary images on your TV screen for extended periods of time. Stationary patterns generated by computer displays, video games, stock market reports, etc. can become permanently engrained on the picture tube. This damage is not protected by your warranty as it is the result of misuse. Should you wish to use your Apex TV/DVD combo to display still images, it is always advisable to reduce brightness and contrast settings. Never leave a video game or computer display unattended.

## BEFORE OPERATION (continued)

# Safety Precautions (continued)

---

**WARNING:**

THE REGION CODE FOR THE UNIT IS 1.

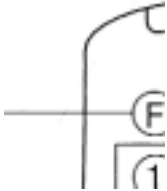

Since it is very usual for DVD movies to be released at different times in different regions of the world, all players have region codes and disks can have an optional region code. If you load a disk of a different region code to your player, you will see the region code notice on the screen. The disk will not play, and should be unloaded.

**NOTE TO CABLE INSTALLER IN THE USA:**

This reminder is provided to call your attention to Article 820-40 of the NEC that provides guidelines for proper grounding and, in particular, specifies that the cable ground shall be connected to the grounding system of the building, as close to the point of cable entry as practical.

# Important Safety Instructions

---

**CAUTION**

PLEASE READ THESE INSTRUCTIONS, KEEP THESE INSTRUCTIONS AND HEED ALL WARNINGS. FOLLOW ALL INSTRUCTIONS.

Electrical energy can perform many useful functions. This TV set has been engineered and manufactured to assure your personal safety. However improper use can result in potential electrical shock or fire hazards. In order not to defeat the safe guards incorporated in this TV set, observe the following basic rules for antenna/ TV installation, use and servicing. All operating and use instructions should be followed.

Do not remove the cabinet cover. This may expose you to dangerous voltages. Refer all servicing to qualified service personnel.

## BEFORE OPERATION (continued)

### Precautions

**Power Sources** - The unit should be operated only from the type of power source indicated on the unit or as indicated in the Operation Manual. If you are not sure of the type of power supply in your home, consult your sales person or your local power company. For unit designed to operate from battery power, or other sources, refer to the operating instructions.

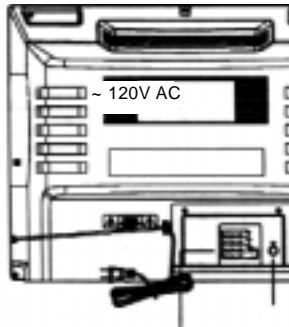

**Grounding or Polarization** - Do not defeat the safety purpose of the polarized or grounding-type plug. A polarized plug has two blades with one wider than the other. A grounding - type plug has two blades and a third grounding prong. The wide blade or the third prong is provided for your safety. If the provided plug does not fit into your outlet, consult an electrician for replacement of the obsolete outlet.

Wide blade  
Lame large  
Cuchilla ancha

**Alternate Warnings** -This plug will only fit into a grounding-type power outlet. This is a safety feature. If you are unable to insert the plug into the outlet, contact your electrician to have a suitable outlet installed. Do not defeat the safety purpose of the grounding plug.



**Water and Moisture Warnings-** Do not use the unit near water-for example, near a bath tub, wash bowl, kitchen sink, or laundry tub; in a wet basement; or near a swimming pool; and the like. The unit shall not be exposed to dripping or splashing and no objects filled with liquids, such as vases, shall be placed on the unit.

**Ventilation-**Slots and openings in the cabinet are provided for ventilation and to ensure reliable operation of the unit and to protect it from overheating, and these openings must not be blocked or covered. The openings should never be blocked by placing the unit on a bed, sofa, rug, or other similar surface. This unit should not be placed in a built-in installation such as a bookcase or rack unless proper ventilation is provided or the manufacturer's instructions have been adhered to.



## BEFORE OPERATION (continued)

### Precautions (continued)

**Heat**-Do not install near any heat sources such as radiators, heat registers, stoves, or other apparatus (including amplifiers ) that produce heat.



**Overloading** -Do not overload wall outlets, extension cords or integral convenience receptacles as this can result in fire or electric shock.



**Lightning**-For added protection for this unit during a lightning storm, or when it is left unattended and unused for long periods of time, unplug it from the wall outlet and disconnect the antenna or cable system. This will prevent damage to the product due to lightning and power-line surges.



**Power-Cord Protection**-Protect the power cord from being walked on or pinched particularly at plugs, convenience receptacles, and the point where they exit from the apparatus.



**Accessories** -Do not place the unit on an unstable cart, stand, tripod, bracket, or table. The unit may fall, causing serious injury to a child or adult, and serious damage to the unit. Use only with a cart, stand, tripod, bracket, or table recommended by the manufacturer, or accessory recommended by the manufacturer, or sold with the TV set, and should use a mounting accessory recommended by the manufacturer.



A product and cart combination should be moved with care. Quick stops, excessive force, and uneven surfaces may cause the unit and cart combination to overturn.



**Object and Liquid Entry**-Never push objects of any kind into the unit through openings as they may touch dangerous voltage points or short-out parts that could result in a fire or electric shock. Never spill liquid of any kind on the unit.

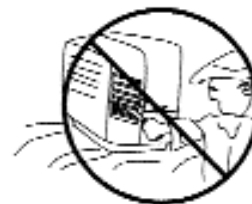

## BEFORE OPERATION (continued)

### Precautions (continued)

**Cleaning**-Unplug the unit from the wall outlet before cleaning or polishing it. Do not use liquid cleaners or aerosol cleaners. Use a dry cloth for cleaning the exterior of the unit.



**Attachments** -Do not use attachments not recommended by the product manufacturer as they may cause hazards or electric shock.



If a snapping or popping sound from a unit is heard continuously or frequently while the unit is operated, unplug the unit and consult your dealer or service technician. It is normal for some unit to make occasional snapping or popping sounds, particularly when being turned on or off.



**Damage Requiring Service** - Unplug the unit from the wall outlet and refer servicing to qualified service personnel under the following conditions:  
a. If the power cord or plug is damaged or frayed.

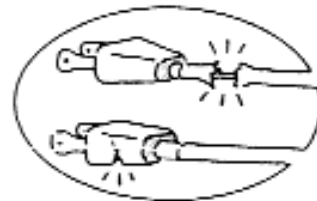

b. If liquid has been spilled or objects have fallen into the unit.

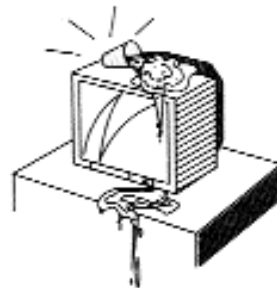

c. If the unit has been exposed to rain or water.



## BEFORE OPERATION (continued)

### Precautions (continued)

d. If the unit has been subject to excessive shock by being dropped, or the cabinet has been damaged.



e. If the unit does not operate normally by following the operating instructions. Adjust only those controls that are covered by the operating instructions as an improper adjustment of other controls may result in damage and will often require extensive work by a qualified technician to restore the unit to its normal operation.

f. When the unit exhibits a distinct change in performance-this indicates a need for service.



**Servicing** - Do not attempt to service the unit yourself as opening or removing covers may expose you to dangerous voltage or other hazards. Refer all servicing to qualified service personnel.

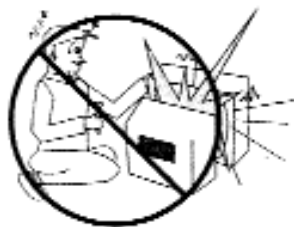

**Replacement Parts** - When replacement parts are required, be sure the service technician has used replacement parts specified by the manufacturer or have the same characteristics as the original parts. Unauthorized substitutions may result in fire, electric shock, or other hazards.



**Safety Check** - Upon completion of any service or repairs to the unit, ask the service technician to perform routine safety checks to determine that the TV set is in proper operating condition.



When the unit reaches the end of its useful life, improper disposal could result in a picture tube implosion. Ask a qualified service technician to dispose of the unit.



## BEFORE OPERATION (continued)

### Precautions (continued)

#### ANTENNA

Outdoor Antenna Grounding-if an outdoor antenna is installed, follow the precautions below.

An outdoor antenna system should not be located in the vicinity of overhead power lines or other electric light or power circuits, or where it can come in contact with such power lines or circuits.

WHEN INSTALLING AN OUTDOOR ANTENNA SYSTEM, EXTREME CARE SHOULD BE TAKEN TO KEEP FROM CONTACTING SUCH POWER LINES OR CIRCUITS AS CONTACT WITH THEM IS ALMOST INVARIABLY FATAL

Be sure the antenna system is grounded so as to provide some protection against voltage surges and built-up static charges. Section 810 of the National Electrical Code in USA and Section 54 of the Canadian Electrical Code(ANSI/NFPA 70) in Canada provides information with respect to proper grounding of the mast and supporting structure, grounding of the lead-in wire to an antenna discharge unit, size of grounding conductors, location of antenna discharge unit, connection to grounding electrodes, and requirements for the grounding electrode.



Example of antenna grounding according to National Electrical Code (NEC )

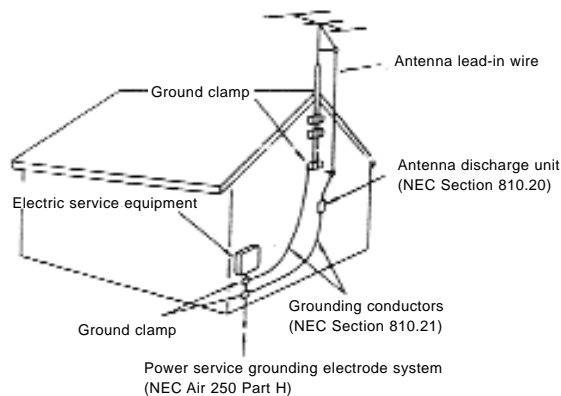



## BEFORE OPERATION (continued)

### **FCC Warning**

#### **Class B Computing Device**

#### **Information to User**

This equipment has been tested and found to comply with the limits for a class B digital device pursuant to part 15 of FCC Rules. These limits are designed to provide reasonable protection against harmful interference in a residential installation. This equipment generates, uses, and can radiate radio frequency energy and, if not installed and used in accordance with the instructions, may cause harmful interference to radio communications. However, there is no guarantee that interference will not occur in a particular installation. If this equipment off and on, the user is encouraged to try to correct the interference by one or more of the following measures:

- 1 ) Reorient or relocate the receiving antenna.
- 2) Increase the separation between the equipment and receiver.
- 3) Connect the equipment into an outlet on a circuit different from that to which the receiver is connected.
- 4) Consult the dealer or an experienced radio/TV technician for help and for additional suggestions.

The user may find the following booklet prepared by the Federal Communications Commission helpful: "How to Identify and Resolve Radio -TV Interference Problems". This booklet is available from the US Government Printing Office, Washington, D. C 20402, Stock No. 004-000-00345-4.

#### **FCC Warning**

The user is cautioned that changes or modifications not expressly approved by the manufacturer could void the user's authority to operate the equipment.

**NOTE:** In order for an installation of the product to maintain compliance with the limits for a Class B device, shielded cables must be used.

## BEFORE OPERATION (continued)

### Notes on Discs

HOW TO HANDLE, CLEAN, AND STORE DISCS.

#### Handling discs

- DO NOT TOUCH THE PLAYBACK SIDE OF THE DISC.
- DO NOT ATTACH PAPER OR TAPE TO DISCS.

**Note:** APEX DIGITAL INC. SHALL NOT BE RESPONSIBLE FOR DAMAGE THAT MAY OCCUR TO A DISC FROM BEING OPERATEDD IN THE UNIT.



#### Cleaning discs



- Fingerpints and dirt on the disc cause picture and sound deterioration. Wipe the disc from the center outward with a soft cloth. Always keep the disc clean.
- If you cannot wipe off the dirt off, wipe the disc lightly with a slightly moistened soft cloth and finish with a dry cloth.
- Do not use any of solvent such as paint thinner, benzine, commercially available cleaners or anti-static spray for vinyl LP's

#### Storing discs

- Do not store discs in places subject to direct sunlight or near heat sources.
- Do not store discs in places subject to moisture and dust.
- Store discs vertically in a case. Stacking or placing objects on discs outside of their case may cause warping.

#### Playable discs

This unit can play back the following discs.

	Disk Mark	Contains	Disc Size	Maximum playback time
DVD video disc		Audio + Video (moving pictures)	12cm	Approx. 4 hours (single sided disc)
				Approx. 8 hours (double sided disc)
Audio CD		Audio	12cm	Approx. 74 minutes
			8cm (CD single)	Approx. 20minutes

#### Notes on regional numbers

DVDs are divided into separate regions. The United States and Canada are designated as region 1 DVD. Your unit plays region 1 DVDs only.

# CONTENTS

## INTRODUCTION

Features.....	10
Control Buttons.....	11

## INSTALLATION

To Connect the Antenna.....	14
Remote Batteries.....	14
To Connect External Equipment.....	15

## TV FUNCTIONS

Power On/Off.....	17
Menus.....	17
Tuning in.....	18
Function Selection.....	18
General Operation.....	20
Time Setting.....	21
Picture Improvement.....	22
Childlock.....	22
Sound Improvement.....	23

## DVD FUNCTIONS

MP3 Operation.....	24
Playing Back a Disc.....	25
Locating a Specific Title, Chapter or Track.....	28
Zooming a Picture.....	30
Selecting the Camera Angle/Language/Audio Settings.....	31
Playing in a Favorite Order.....	32
Selecting Subtitles.....	33
Playing Repeatedly.....	33
Playing Back Your KODAK Picture CD.....	34
Playing Your JPEG Files.....	35
Using the On-screen Display.....	36
Setting the Parental Lock.....	37
Customizing the Function Settings.....	38

<b>SPECIFICATIONS.....</b>	<b>39</b>
----------------------------	-----------

<b>TROUBLESHOOTING GUIDE.....</b>	<b>40</b>
-----------------------------------	-----------

<b>TV / DVD Combo Warranty Information.....</b>	<b>41</b>
---	-----------

### Note:

The OSD and illustration in this manual may be somewhat different from the actual situation.  
Please take the unit as the standard.

## INTRODUCTION

### Features

#### **True Flat Picture Tube**

- Delivers real pictures, which ensures that you can watch sharper and more natural pictures. By adopting the invar shadow-mask, the tube increases the transparency and reduces thermal deformation, which greatly improves the picture stability and delivers more vivid pictures.

#### **English/French/Spanish Menus**

- The unique English/French/Spanish menu control function makes the operation more easily.

#### **181 Channel Tuner**

- 2-69 channels in the Air mode and 1-125 channels in the Cable mode can be preset (of which 2-13 channels in the Air and Cable modes are the same.)

#### **DVD/CD/MP3/KODAK Picture CD Support**

#### **AV/S-VIDEO/AC-3 Terminals for External Equipment Connection**

#### **On/Off Timer**

- The TV automatically turns off and on and tunes to the desired channel at the time when programmed.

#### **Auto Off**

- Under no signal condition, the TV will turn off in 15 min.

#### **Childlock Function**

- Prevents children from watching TV for a long period of time. Especially when parents are out .

#### **Parental Control**

- Prevents children from watching programs not suitable for them.

#### **Quick Selectable Picture/Sound Modes**

- Allows one-touch selection of your favorite picture and sound quality among three picture modes and four sound modes.

#### **CCD /Text Function**

- If they are included in a program, you can view closed captions or text information.

#### **Correction Technology**

- Reduces picture noise and improves color quality.

#### **Black Level Stretch**

- The black level stretching circuit enhances the picture gradation.

#### **Digital Geometric Correction**

- The TV adopts digital geometric correction with no mechanic adjustment, which offers the TV reliability.

#### **Channel Scan**

- Displays all channels set in the Add mode.

#### **MTS Stereo**

#### **AVC - Auto Volume Correction**

## INTRODUCTION (continued)

### Control Buttons

#### Front panel

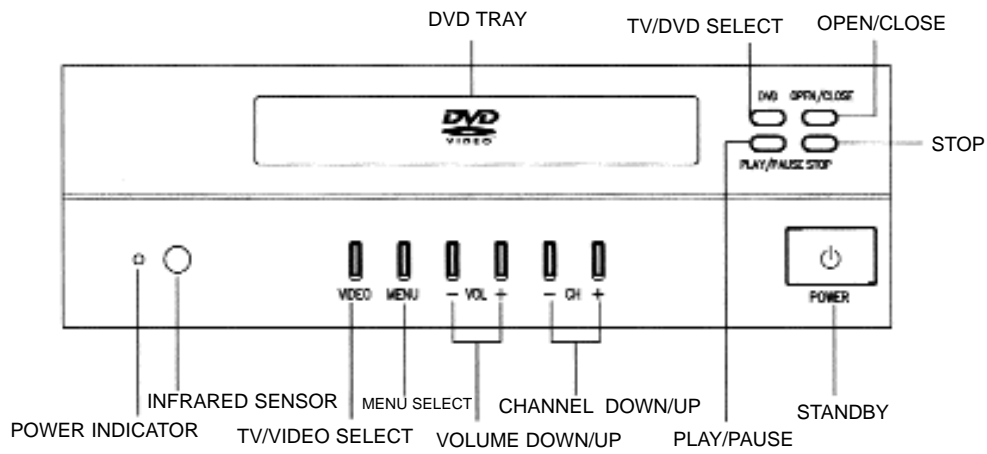

**Note:**

The buttons on the unit share the same functions with those buttons of the same name on the remote control. The following section of this manual will focus on operation of the remote control.

#### Rear panel

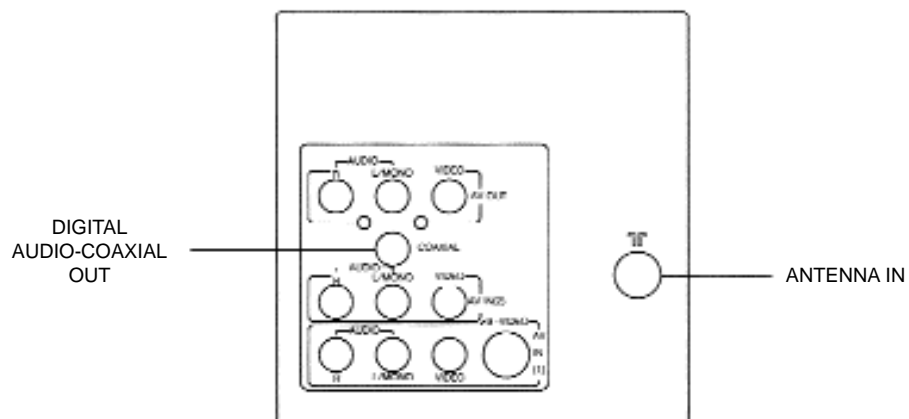

## INTRODUCTION (continued)

### Control Buttons (continued)

#### Remote control

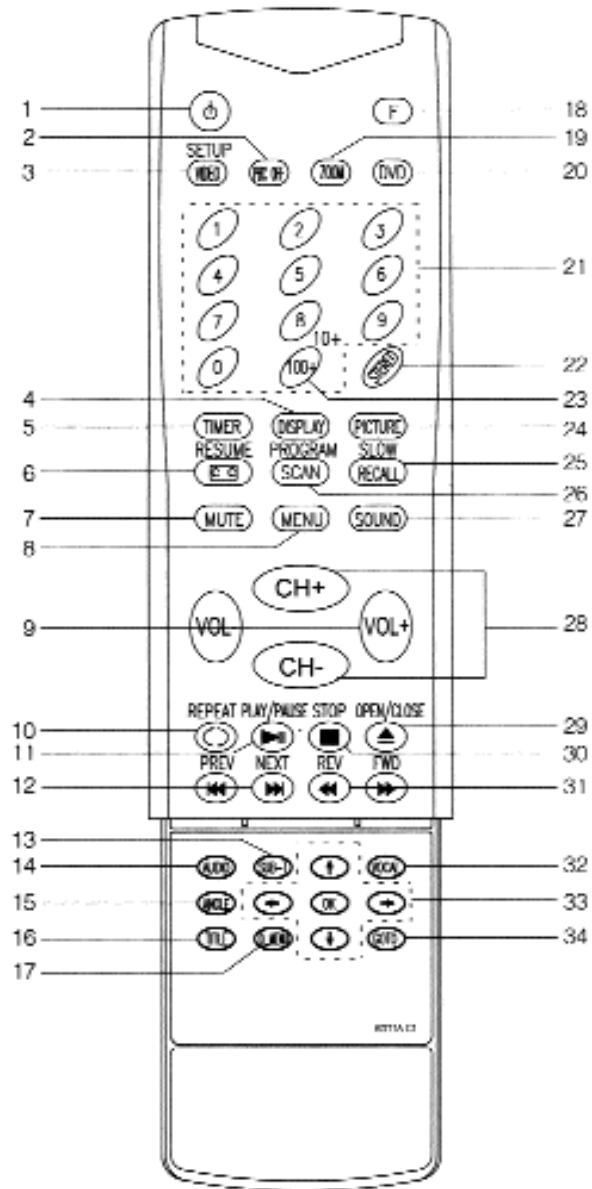

#### Notes:

- ① When in operation, please point your remote control directly to the infrared sensor.
- ② Do not expose the remote control to impacts, water or disassemble it.
- ③ Do not repeatedly press the buttons on the remote control. Allow interval of no less than one second between selections.
- ④ When " " displayed the function is not operational.

## INTRODUCTION (continued)

### Control Buttons (continued)

The buttons marked with \* have composite functions and the buttons in boldface type function for DVD only as shown below.

No.	Button	Function Description	
		TV	DVD
1		Standby	
2	<b>PBC OFF</b>	—	
*3	VIDEO ( <b>SETUP</b> )	TV/Video select	Setup
4	DISPLAY	On-screen display	
5	TIMER	Time setting	
*6	 ( <b>RESUME</b> )	CCD/Text	Resume
7	MUTE	Mute on/off	
8	MENU	Menu select	
9	VOL-/VOL+	Volume down/up	
		To adjust items in the menus	—
10	<b>REPEAT</b>	—	Repeat
11	<b>PLAY/PAUSE</b>	—	Play/Pause
12	<b>PREV/NEXT</b>	—	Previous skip/ Forward skip
13	<b>SUB-T</b>	—	Sub title
14	<b>AUDIO</b>	—	Audio
15	<b>ANGLE</b>	—	Angle select
16	<b>TITLE</b>	—	Title
17	<b>D.MENU</b>	—	DVD menu
18	F+VOL-/ F+VOL+	Decrease/Increase volume by 4 levels	
	F+MUTE	Childlock	
19	<b>ZOOM</b>	—	To zoom picture
20	<b>DVD</b>	TV/DVD select	
*21	0-9	Channel number (0-9)	Number (0-9)
22	STEREO	Stereo	—
*23	100+(10+)	Three-digit select	Press it once to increase number by 10
24	PICTURE	Picture mode select	
*25	<b>RECALL(SLOW)</b>	Recall	Slow playback
*26	<b>SCAN(PROGRAM)</b>	Channel scan	Program
27	SOUND	Sound mode select	
28	CH-/ CH+	Channel down/up To move the cursor in the menus	—
29	<b>OPEN/CLOSE</b>	—	Open/ Close
30	<b>STOP</b>	—	Stop
31	<b>REV/ FWD</b>	—	Fast rewind/Fast forward
32	<b>VOCAL</b>	—	Vocal
33	↑ ↓ ← → /OK	—	To move the cursor/ To access an option
34	<b>GOTO</b>	—	Goto

## INSTALLATION

- Please read the safety instructions in this manual completely before installation.
- Install your unit in a room where direct sunlight will not fall upon the screen.
- Allow enough space (at least 10cm) between the unit and the wall for proper ventilation.
- It is recommended to watch TV in soft and indirect light. The optimum watching distance is 5-7 times of the screen's vertical height.

### **Auto-degaussing**

Color TV is easily affected by magnetism which leads to color distortion. If your unit is moved or affected by near magnetic components or appliances with power on, please power off your unit for at least 1 hour. The built-in auto-degaussing circuit will eliminate the magnetism interference.

### **To Connect the Antenna**

An outdoor antenna or CATV is recommended for the best reception.

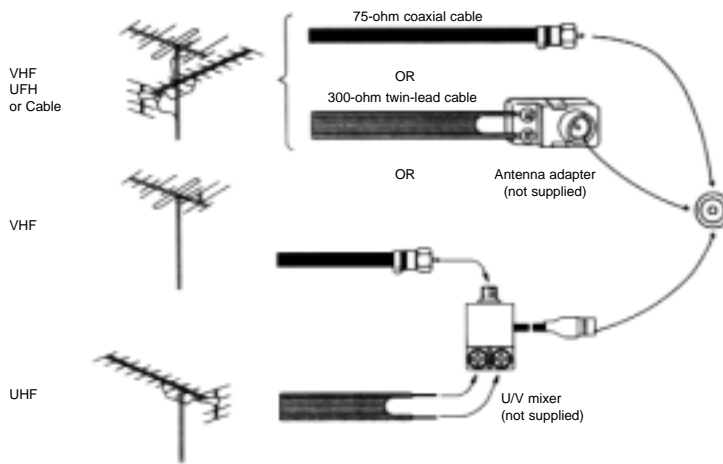

### **Notes:**

- ① It is recommended that a 75Ω coaxial cable be used in order to eliminate possible interference and noise which may occur due to nearby radio transmissions.
- ② The antenna cable should not be tied together with other wiring.
- ③ Set up a lightning arrester and check it regularly when an outdoor antenna is used.

### **Remote Batteries**

- ① Remove the battery compartment lid.
- ② Place in two AAA batteries. Make sure the positive ⊕ and negative ⊖ polarities are correct.
- ③ Reattach the battery lid.

### **Notes:**

- ① Alkaline batteries are recommended for longer life. Always replace both batteries with fresh ones of the same type.
- ② Do not expose batteries to fire or disassemble them.
- ③ To avoid battery leakage, remove batteries from the remote control when it is not to be used for a long period of time or the batteries are exhausted.



## INSTALLATION (continued)

### To Connect External Equipment

The following are optional connections. Refer to operation manuals of external equipment that will be connected to your unit.

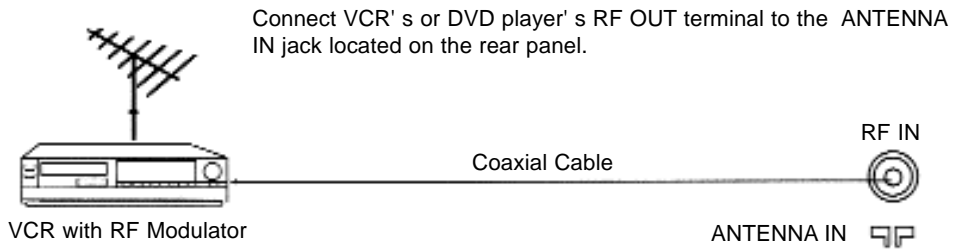

#### AUDIO/VIDEO OUT

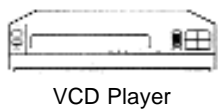

With S-VIDEO Terminal

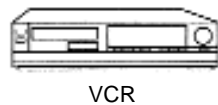
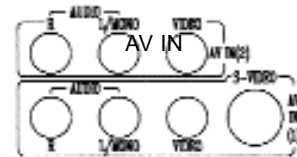
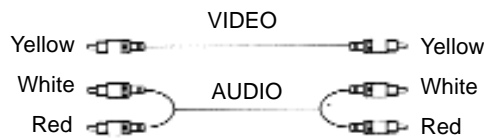
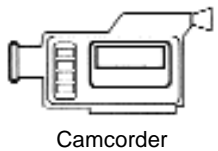

#### AUDIO/VIDEO IN

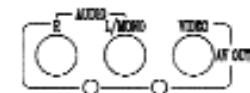
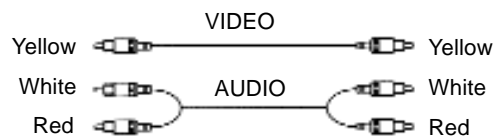
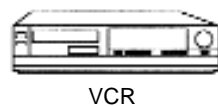

#### Notes:

- ① Before connection, do power off your unit and external equipment.
- ② S-VIDEO and AV1 IN terminals share the same AUDIO IN terminals.

## INSTALLATION (continued)

### To Connect External Equipment (continued)

#### Enjoying Digital Stereo Sound (Digital Stereo)

Enjoy the dynamic sound of Digital Stereo by connecting an amplifier equipped with a digital audio input and speaker system (right and left front speakers).

**Set "AUDIO OUT" to "SPDIF/PCM" via the setup menu.**

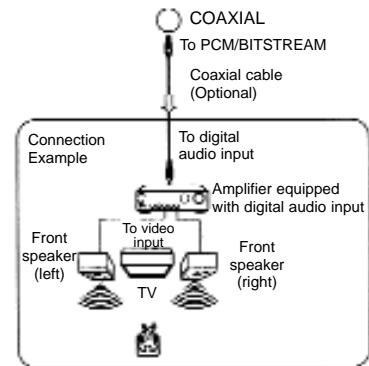

#### Enjoy DTS

DTS programming can deliver surround sound with five discrete full range channels plus a sixth channel for a subwoofer. You can enjoy your APEX unit with a DTS Digital Surround Sound System. All you need is to connect your unit to a DTS receiver with an external decoder.

##### **How to setup the sound output:**

From the SETUP MENU display, select General Setup by pressing OK Use button, set "AUDIO OUTPUT" to "SPDIF/RAW".

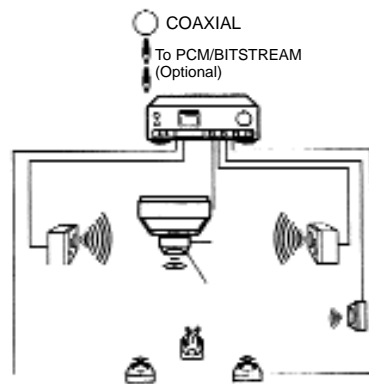

This product incorporates copyright protection technology that is protected by method claims of certain U.S. patents and other intellectual property rights owned by Macrovision Corporation and other rights owners. Use of this copyright protection technology must be authorized by Macrovision Corporation, and is intended for home and other limited viewing uses only unless otherwise authorized by Macrovision Corporation. Reverse engineering or disassembly is prohibited.

It is forbidden by law to copy, broadcast, show, play in public, or rent copyrighted material without permission.

DVD video discs are copy protected, and any recordings made from these discs will be distorted.

#### Notes:

- ① Do not connect the PCM/BITSTREAM jack of the unit to the AC - 3 RF input of a Dolby Digital receiver, Instead, connect to the "DIGITAL" or "COAXIAL" input of a Dolby Digital/DTS receiver or Processor. The input of the AV receiver is not compatible with the PCM/BITSTREAM jack and is primarily for Laserdiscs only.
- ② Connect the PCM/BITSTREAM jack of the unit to the "DIGITAL" or "COAXIAL" input of a DTS receiver or Processor.
- ③ Refer to the manual of the connected Equipment.
- ④ Adjust the volume of your receiver to a comfortable listening level to avoid any speaker damage.

## TV FUNCTIONS

### Power On / Off

#### 1. Power on

Plug in the supply socket, the power indicator lights and the TV automatically enters the Standby mode. In this case, you may press the POWER button on the unit or  on the remote control to turn on the TV. A position number will appear on the upper-right corner of the screen.

#### 2. Power off

When the TV on the Power On mode, press the POWER button on the unit or  on the remote control to enter the Standby mode. At this time, part of circuit on the unit remains active.  
To cut the power off completely, please unplug the unit.

#### Auto off when no signal received

When a channel has no signal (e. g. the program is over) and if no button is pressed within 15 minutes, the TV will automatically enter the Standby mode. If the Off Time is preset and the time left is less than 15 minutes, the TV will carry out the Off Time program prior to the auto-off.

### Menus

Press the MENU button, and the TV will display the primary menu as right:

To adjust a function, press the CH-/ + buttons to highlight the selection, and press the VOL -/+ buttons to call up a sub-menu. (Take English menu for example).

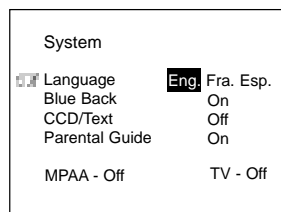
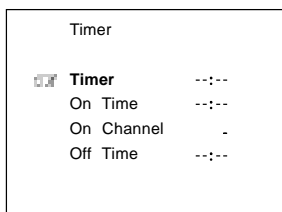
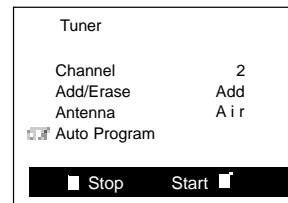
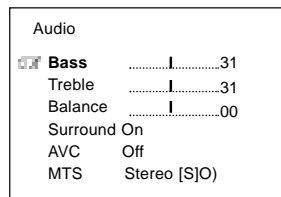
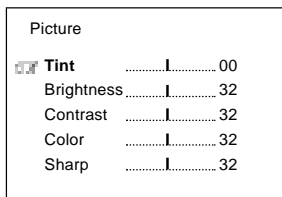
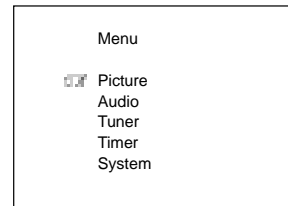

After selecting a sub-menu, press the CH-/ + buttons to highlight the desired item and press the VOL -/+ buttons to adjust. MENU display except "Tuner" disappears 6 seconds after last selection.

Notes:

- ① After calling up the sub menu, pressing the MENU button can return to the primary menu display.
- ② The adjustable Tint range in the Picture menu and Balance range in the Audio menu are -31~+31 and L31~R31 respectively while the other adjustments are 0 ~ 63.
- ③ When the Tuner menu is recalled, the display will not disappear automatically. Press the **DISPLAY** button on turn off the menu display.

**In the following function introductions, the operations are similar to the above ways unless otherwise noted.**

## TV FUNCTIONS (continued)

### Tuning in

This section gives descriptions about adjustment of items in the Tuner menu.

#### 1. Auto program

- 1) Press the CH-/ + buttons to highlight “ Auto Program”.
- 2) Press the VOL+ button, and the TV will search automatically in sequence. After auto search, the TV will store receivable channels and return to the lowest channel number.  
During auto program, press the VOL- button to stop searching.

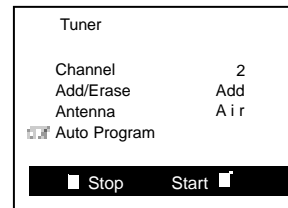

#### Notes:

- ① After auto program, there may be some repeated channels or inferior signal received. In this case, press any of the VOL- / + , Channel Number buttons to select one of the channels. Then set Add/ Erase to Erase so that pressing the CH - / + buttons can not call up the channels. To resume the channels, set Add/Erase to Add in the way mentioned above.
- ② When Antenna is set to the Air mode, the TV will auto search from channel number 2 to 69; when set to the Cable mode, it will auto search from 1 to 125 (of which 2 -13 channels in the Air and Cable modes are the same.)

#### 2. Channel selection

Press the CH-/ + buttons to highlight “ Channel” in the Tuner menu, and press any of the VOL- / + , Channel Number buttons to select channel numbers.

#### 3. Add/Erase selection

Press the CH-/ + buttons to highlight “ Add / Erase”, and press the VOL - / + buttons to select “ Add ” or “ Erase” cyclically.

### Function Selection

#### 1. Language selection

- 1) Press the CH- /+ buttons to highlight “Language”.
- 2) Press the VOL- /+ buttons to select a desired language display (English/ French/Spanish).

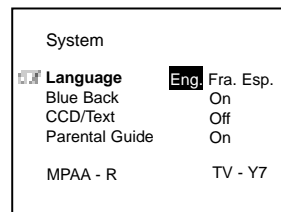

#### 2. Blue screen display

When there is no signal received with Blue Back On, the TV will display a soft blue background on the screen.

- 1) Press the CH- /+ buttons to highlight “ Blue Back”.
- 2) Press the VOL- / + buttons and set Blue Back to On.

#### Notes:

If Blue Back is set to Off, noise dots will be displayed on the screen when no signal is present in the TV mode or the screen will become dark in the AV mode.

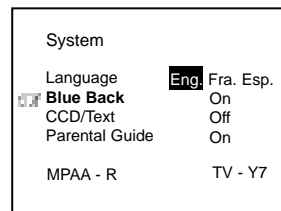

#### 3. Closed caption function

Closed caption provides an on-screen display of the dialogue, narration, and / or sound effects of a TV program. When available in a program, you can view closed captions or text information.

- 1) Press the CH- / + buttons to highlight “ Closed Caption ”.
- 2) Press the VOL-/ + buttons to select one of the 9 modes.

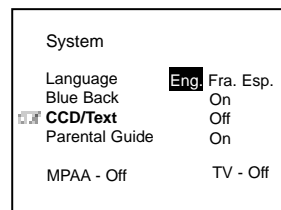

## TV FUNCTIONS (continued)

### Function Selection (continued)

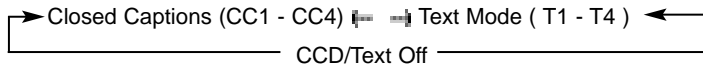

When you select the Closed - Caption (CC1-CC4) mode, the TV can decode CCD signal, which is especially helpful for hearing impaired individuals.

When you select the Text Mode (T1-T4), the TV can receive teletext signal.

**Notes:**

- A CCD signal may not be decoded in the following conditions:
  - When a video tape has been dubbed.
  - When the signal reception is weak.
  - When the signal has been changed or altered.
- With signal received without Closed Captions or Text, closed captions or text characters do not appear on the screen.

#### 4. Parental Control

You may prevent children from watching programs not suitable for them, such as sexual or violence programs.

Press the CH- /+ buttons to highlight “ Parental Guide ” (provided it has been preset).

Use the Channel Number buttons to enter the initial pass code 6688, then press the VOL+ button again to proceed to the next menu display.

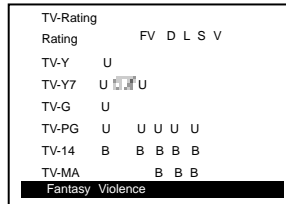
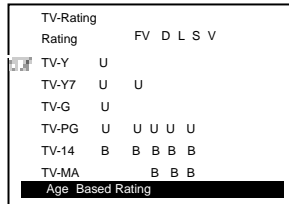
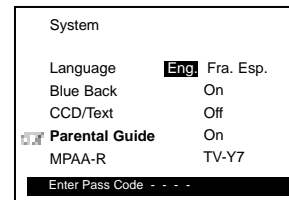

The TV ratings are divided into two groups: age - based and content - based.

Age	Defined as
TV - Y	All Children
TV - Y7	Directed to Older Children
TV - G	General Audience
TV - PG	Parental Guidance Suggested
TV - 14	Parents Strongly Cautioned
TV - MA	Mature Audience Only

Contents	Defined as
FV	Fantasy Violence
D	Sexually Suggestive Dialogue
L	Adult Language
S	Sexual Situations
V	Violence

Press the CH- /+ buttons to highlight one of the items. Press the MENU button to display “U” or “B” on the screen. A “U” indicates a rating which is unblocked and a “B” indicates a rating which is blocked.

Press the VOL+ button to cycle the selections.

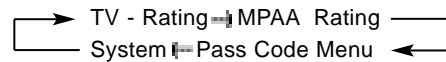

Press the VOL+ button repeatedly to recall the Pass Code Menu as follows.

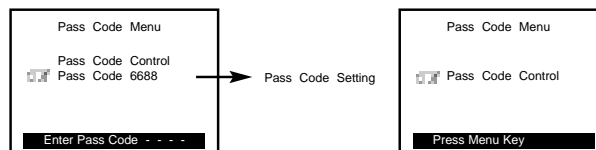

## TV FUNCTIONS (continued)

### Function Selection (continued)



After calling up the Pass Code Menu first, press the CH- / + buttons to highlight "Pass Code 6688", and then "Enter Pass Code - - - -" appears on the screen. Press the Channel Number buttons to enter new pass code which you need enter when calling up the Parental Guide Menu.

**Notes:**

- ① If you forget the new pass code when turning on the Parental Guide Menu display, you may enter the initial pass code 6688.
- ② If you wouldn't like to set any pass code, press the CH- / + buttons to highlight Pass "Code Control" and MENU button to turn off the pass code setting display.

### General Operation

#### 1. To control volume



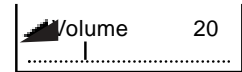

- 1)   Press the VOL -/ + buttons to decrease or increase the volume.
  
-  While adjusting volume, hold down the F button, then press the VOL-/+ buttons to decrease or increase volume by 4 levels.

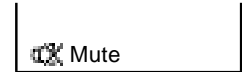



- 2)  During normal play, press the MUTE button to eliminate the sound until you press the VOL + or MUTE button again.

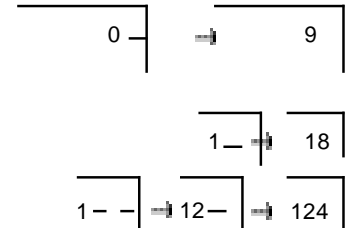

#### 2. To select a channel

- 1)  Press the CH + button to choose higher-numbered channels and the -CH button to choose lower-numbered channels.
  
- 
  
- 2)  -  Using the Channel Number buttons
  - To select a one -digit channel number  
Press the 0 button, then press another Channel Number button (except 100+) to select a desired number.
  - To select a two -digit channel number  
Enter a first-digit, then second-digit.
  - To select channel number between 100 and 125 in the Cable mode  
Press the 100+ button so that "1\_ \_" appears on the screen, then enter the next digit one and two.
  
- 



- 3)  Press the RECALL button and the TV will directly skip back to the previous channel.  
**Note:**  
In the Video mode, pressing the RECALL button can return to the TV mode.
  
- 4) 
  - ① Press the SCAN button so that " Scan Off " appear on the screen.
  - ② Press the SCAN button again so that "Scan On "appear on the screen and the TV begins to scan from the current channel.**Note:**  
During scanning, pressing any button can interrupt scanning.

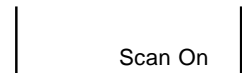

## TV FUNCTIONS (continued)

### General Operation (continued)

#### 3. On-screen display



Press the DISPLAY button repeatedly in the TV or Video mode to display the current mode on the screen and turn off the display respectively.  
With other OSD, pressing the DISPLAY button first can turn it off.

#### 4. CCD/Text switch



Press the CC button to display the current Closed Captions/Text mode on the screen. Press the button again to display "CCD/Text Off" on the screen

#### 5. TV/Video selection



Press the VIDEO button, and the screen display changes in circular way:

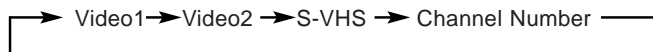

To receive signals from external equipment, please be sure to select a corresponding Video mode.

**Notes:**

In the Video mode, pressing the CH-/CH+ buttons can return to the TV mode.

#### 6. Stereo selection



In the TV mode, the TV can automatically identify MTS stereo modes among Mono, Stereo, and SAP. Press the STEREO button firstly to display the auto-identified MTS mode on the screen. Press the button again before the OSD disappears to shift to other MTS mode as follows.  
With Stereo/SAP signal received, you may select one of the SAP, Stereo and Mono modes cyclically.  
With Stereo signal received, you may select one of the Stereo and Mono modes cyclically.  
With Mono signal received, only Mono mode can be available.

## Time Setting

In the Standby or Power On mode, the TV can automatically complete some functions such as power-on, channel preset and power-off as desired.

- 1 . Press the TIMER button to turn on the Timer menu display as shown right.
- 2 . Press the CH- / + buttons to select an adjustment.
- 3 . Press the VOL- / + buttons to adjust the selection.

For example, now it is 6:00PM, you have set On Time, On Channel and Off Time to 7:00PM, 22 and 8:00PM respectively. The TV will automatically perform the above settings in the Standby or Power On mode.

**Notes:**

- ① Only after setting "Time", can you set other items.
- ② If the TV is powered off, all the settings will automatically be cancelled.

Timer	
Timer	--:--
On Time	--:--
On Channel	-
Off Time	--:--

Timer	
Time	6:00PM
On Time	7:00PM
On Channel	22
Off Time	8:00PM

## TV FUNCTIONS (continued)

### Picture Improvement

#### 1. To select picture modes



Press the PICTURE button repeatedly to select one of the Normal, Memory and Theater modes.

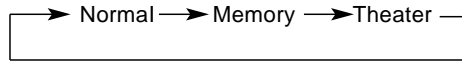

Refer to the following introduction about each mode.

Mode	Picture Quality
Normal	Standard mode, suitable for watching ordinary program.
Memory	Picture quality users set.
Theater	Movie-like picture setting, suitable for viewing some movie programs.

#### 2. To set desired picture quality

1) Call up the Picture menu and the TV screen is displayed as follows.

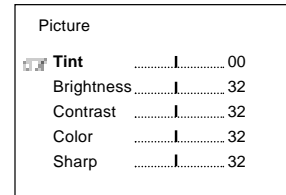

2) Press the CH- / + buttons to choose an adjustment.

3) Press the VOL-/+ buttons to adjust the digital level of the selected adjustment as desired.



The adjusted level is stored in the MEMORY position and remains unchanged until next adjustment.

Item	Picture Quality	
	Press the VOL-button	Press the VOL-button
Tint	Purplish	Greenish
Brightness	Darker	Brighter
Contrast	Lower	Higher
Color	Paler	Deeper
Sharp	Softer	Sharper

### Childlock

The CHILDLOCK function prevents children from watching TV.

Hold down the F button and then press the MUTE button until the symbol “” appears on the screen, and the TV enters the CHILDLOCK mode.

Except for the symbol “”, the screen becomes blue back and mutes when you press the  button to turn the TV off, then turn the TV on after setting the CHILDLOCK function. To unlock the TV, hold down the F button and then press the MUTE button again.

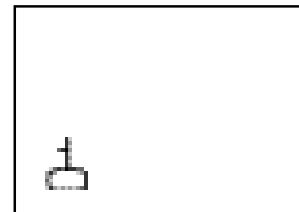

#### **Note:**

The CHILDLOCK can be set or cancelled only by the remote control. After setting CHILDLOCK, secure the remote control in a safe place.



## TV FUNCTIONS (continued)

### Sound Improvement

#### 1. To select sound modes



Press the SOUND button repeatedly to select one of the Speech, Music, Theater and Memory modes.

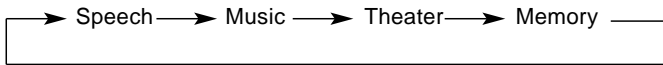

Refer to the following introduction about each mode.

Mode	Sound Quality
Speech	Language clarity improvement, suitable for program focusing on dialogue
Music	Suitable for enjoying music programs
Theater	Movie-like sound setting, suitable for enjoying dynamic sound, such as programs of entertainment
Memory	Sound quality users set

#### 2. To set desired sound quality

1) Call up the Audio menu.

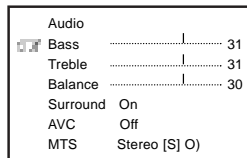

2) Press the CH-/+ buttons to select an adjustment.

3) Press the VOL- /+ buttons to adjust the digital level of the selected item as desired.

The adjusted level is stored in the Memory position and remains unchanged until next adjustment.

Item	Sound Quality	
	Press the VOL- button	Press the VOL+ button
Bass	Weaker	Stronger
Treble	Weaker	Stronger
Balance	Decrease the right volume	Decrease the left volume
Surround	On,Off	
AVC	On,Off	
MTS	Refer to "Stereo selection".	

## DVD FUNCTIONS

### MP3 Operation

#### Playing an MP3 format

1. To play you must view through your television. Insert an MP3 CD, the DVD player will initialize the disc when the tray is closed and the directory (folder) will be shown in an MP3 MENU on screen.
2. Press ←/→ twice to select and highlight the PLAY MODE.  
Then press ↑/↓ each way to select play mode options (repeat, shuffle, etc.)  
Then press ←/→ twice then press the ↑/↓ button to select and highlight an MP3 file (song).  
Press **OK** to highlight your list of songs.
3. Press **OK** or **PLAY** to play the MP3 file. Press the **PREV** or **NEXT** during playback to skip the tracks. If you need to return to the main directory (folder), press **STOP**, then press ↑/↓ / ←/→ to return.

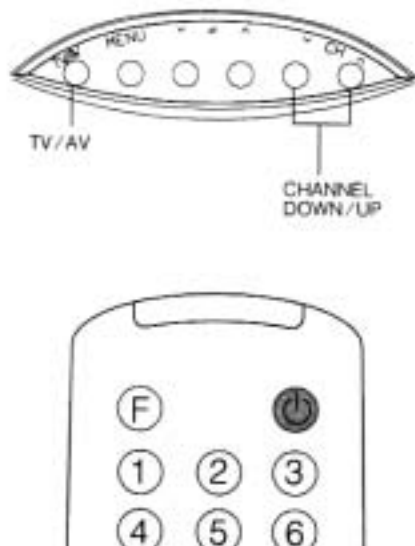

---

#### Notes:

- ① The upper left column is a list showing the name of the folder. The upper right column is a list showing the name of the song and the sub-folder.
- ② “ ” sign in front of a file name indicates that this is a folder, not a MP3 file.
- ③ “MP3” sign in front of a file name indicates that this is a MP3 file.
- ④ During MP3 playback, you cannot access to “PLAY MODE” folder or songs.
- ⑤ You are allowed a maximum of 11 characters for each folder or song.
- ⑥ For “SHUFFLE” playback, you are allowed to playback randomly in a folder only.

## DVD FUNCTIONS (continued)

### Playing Back a Disc

#### 1. How to playback a disc

##### Basic playback

- Turn on the audio system and choose the input source that is connected to the unit.  
Set the AUDIO OUTPUT to ANALOG from the SETUP MENU display if you don't have the necessary equipment to enjoy Dolby Digital or DTS surround sound.

---

1) Press the **DVD** button to enter the DVD mode.



2) Press the **OPEN/CLOSE** button.  
This will open the disc tray.



3) Place the disc on the disc tray.



##### Notes:

- ① A disc may be damaged if not correctly placed on the guides in the disc tray. This may also cause the DVD playback to malfunction.
- ② Do not force or place anything other than 5" DVD's or CD's on the disc tray.

Be sure the playback side is faced down.

4) Press the **PLAY/PAUSE** button.  
After closing the disc tray playback will start.  
If the disc you want to playback is a DVD or CD, the DVD player will start playback automatically.

##### Notes:

The menu screen will appear automatically or you may access the menu screen by pressing the **TITLE** button.

---

##### Notes:

- ① Moving the unit during playback may cause damage to the disc as well as the unit.
- ② To open and close the disc tray, you should use the OPEN/CLOSE button on the remote control or the unit.

#### 2. For a higher quality picture

DVD discs produce a high resolution picture. This may cause some picture artifacts on the TV during playback. To control picture artifacts reduce the sharpness setting on your TV when viewing DVD discs.

#### 3. About DVD CD

**DVD or CD** icons will appear depending on the disc being played back.

**DVD:** DVD video discs

**CD:** Audio CDs

To FAST FORWARD/REVERSE press the **FWD/REV** buttons on the remote control.

## DVD FUNCTIONS (continued)

### Playing Back a Disc (continued)

#### 4. How to start playback from the menu screen

1) Press ↑/↓ / ←/→ or the Number buttons to select the title

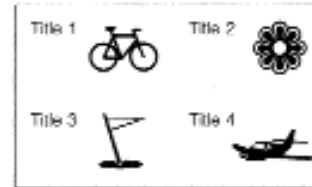

2) Press the **OK** button.

The DVD player will start playback from the title selected.

#### 5. How to pause playback (still playback)

Press the **PAUSE** during playback.  
Press the **PAUSE** button to resume normal playback.



#### 6. How to stop playback

Press the **STOP** button.  
The DVD player is stopped.  
Press the **PLAY** or **RESUME** button to replay.  
Press the **STOP** button twice.



#### 7. How to remove the disc

Press the **OPEN/CLOSE** button.  
Wait until the disc tray is completely open before removing any discs.  
After removing the discs, press the **OPEN/CLOSE** button to close the disc tray.



#### Note:

At the completion of each movie a menu screen will appear. Be aware that the on-screen setup menu may damage your TV by permanently burning that image onto the screen. To avoid this, press the **STOP** button at the completion of each movie. You may also decide to setup the **SCREEN SAVER**.

#### 8. Playing in slow-motion

A disc can also be played back in slow-motion.

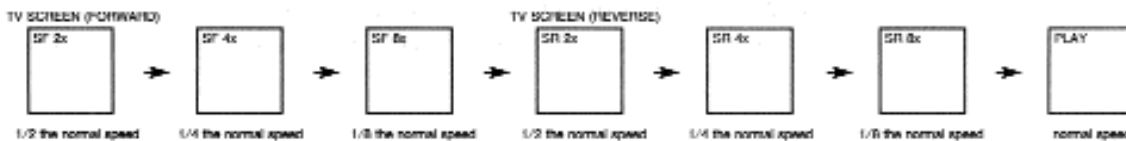

Press the **SLOW** button during playback

The playback speed becomes 1/2, 1/4, or 1/8 of the normal speed each time you press the **SLOW** button.

(Reverse slow play as the same.)

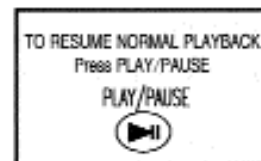

#### Notes:

- ① During the slow-motion playback, the sound is muted.
- ② MP3 CD/CDDA does not utilize this feature.

## DVD FUNCTIONS (continued)

### Playing Back a Disc (continued)

#### 9. Playing at 2X 4X 6X or 8X the normal speed

You can play back a disc at 2X, 4X, 6X or 8X the normal speed.

Press the **REV** or **FWD** button during playback.

The playback speed becomes 2X the normal speed.

The playback speed changes each time you press the **REV** or **FWD** button.

REV: Fast reverse    ⏮

FWD: Fast forward    ⏭

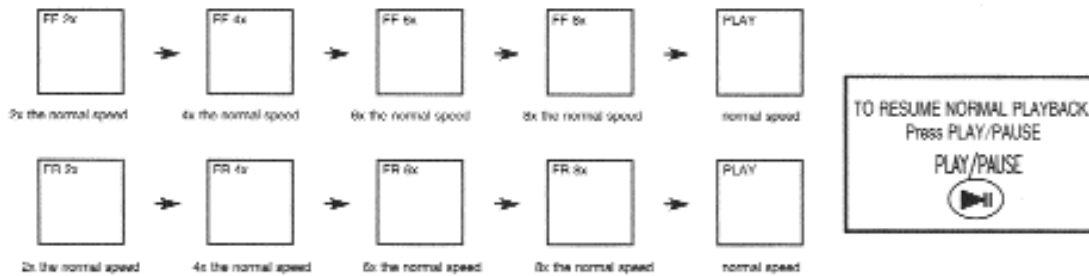

- Audio CD

The reverse of forward playback alternates between 1X, 2X, 3X, 4X speed.

Notes:

- ① The DVD player will not playback sound and subtitles during scan reverse and forward playback of DVD video discs and audio CDs. The DVD player will play sound during fast forward or fast reverse playback of MP3 CDs.
- ② The speeds may vary slightly from disc to disc and are only approximate.

#### 10. Resuming playback from the same location

This DVD player allows you to stop playback and continue playback later from the same location on the disc.

1) Press the **STOP** button.

This will interrupt the playback and the DVD player will memorizes the location where you stopped playback.

2) Press the **PLAY/PAUSE** or **RESUME** button.

The DVD player will resume the playback from the location where you stopped playback.

Notes:

- ① The following actions will cancel the RESUME function:
  - Unplugging the unit after you stop playback.
  - Ejecting the disc.
  - Adjusting/changing the parental lock or selecting a different language setting.
- ② On occasion depending on the disc, you may experience a difference of location where playback resumes.
- ③ MP3 CD does not utilize this feature.

## DVD FUNCTIONS (continued)

### Locating a Specific Title, Chapter or Track

THE DVD VIDEO DISCS ARE NORMALLY DIVIDED INTO TITLES. THE TITLES ARE SUB-DIVIDED INTO CHAPTERS. MOREOVER, AUDIO CD and MP3 CD ARE DIVIDED INTO TRACKS. YOU CAN CONVENIENTLY LOCATE ANY SPECIFIC TITLE, CHAPTER, OR TRACK WITH THIS UNIT.

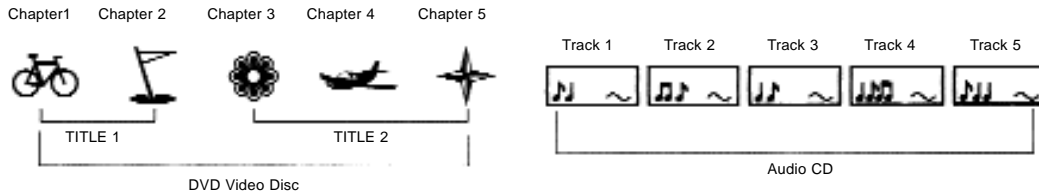

#### 1. Locating a title using the title menu

You can locate a specific title using the title menu function, if a DVD video disc contains a title menu.

- 1) Press the **TITLE** button.

On the TV screen, the title menu will appear.

- 2) Press the **↑/↓ / ←/→** buttons select the title you want.

You can also directly locate a specific title by pressing its assigned number with the **Number** buttons.

- 3) Press the **OK** button.

This will cause the unit to start playback from chapter 1 of the title selected.

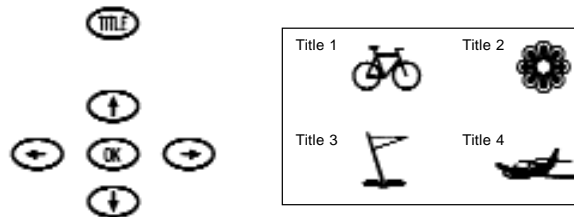

Example of a title menu.

#### Notes:

- ① You may find that some discs will not respond to this function.
- ② If different instructions appear on the TV screen, follow those instructions. The instructions above are describing the basic procedure where the procedures may vary depending on the contents of the DVD video disc.

#### 2. Locating a specific chapter or track

This unit allows you to locate consecutive chapters or tracks.

Press the **PREV** or **NEXT** button repeatedly to display the requested chapter or track. The DVD player starts playback from the selected chapter or track.



##### How to locate preceding chapters or tracks

- When you press the **PREV** button, the DVD player starts playback from the beginning of the preceding chapter or track.



##### How to locate succeeding chapters or tracks

- When you press the **NEXT** button, the DVD player starts playback from the beginning of the succeeding chapter or track.



**Note:** On some discs the titles may not display the sub-divided chapters.

## DVD FUNCTIONS (continued)

### Locating a Specific Title, Chapter or Track (continued)

#### 3. Locating a title

If a DVD video disc contains title numbers, you can locate a specific title by directly selecting a title number.

1) Press **GOTO** during playback.

Make sure that the space next to TITLE is highlighted.



2) Press the Number buttons to select the title and chapter you want.

e.g. To select title 2



To select title 16:

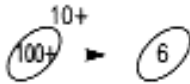

To select title 26:

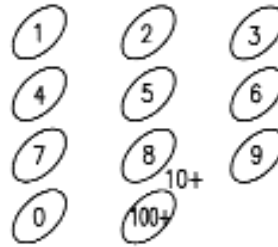

PLAY/PAUSE



3) Press **PLAY/ PAUSE** or **OK** button.

#### Notes:

By pressing **↑/↓** / **←/→** **OK** you may shift the highlights between the TITLE and CHAPTERS.

To select the time, you can press the **GOTO** twice.

## DVD FUNCTIONS (continued)

### Zooming a Picture

#### Zooming a picture

This DVD player allows you to zoom into a picture as well as shift the zoom point.



Press **ZOOM** during normal playback or slow-motion.  
The DVD player magnifies in the center of the picture.



If you press ↑/↓ / ←/→ during zoom playback, the zoom point shifts.

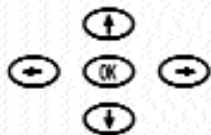

**TO RESUME NORMAL PLAYBACK.**  
Press ZOOM during zoom playback.

ZOOM

### Vocal Assist

Vocal cancel:

Eliminates the vocal sound from the music recorded in a disc.

The vocal cancel function may not work on some discs.

VOCAL



## DVD FUNCTIONS (continued)

### Selecting the Camera Angles / Language / Audio Settings

THIS UNIT ALLOWS YOU TO SELECT FROM SEVERAL DIFFERENT ANGLES AND LANGUAGES.

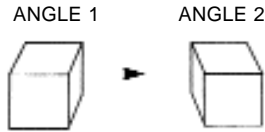

Selecting the camera angle

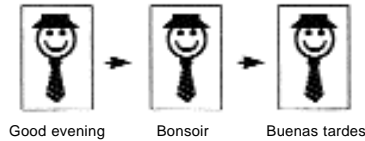

Selecting a language

#### 1. How to change the camera angle

Press the **ANGLE** button while playing back a scene recorded with multiple angles.

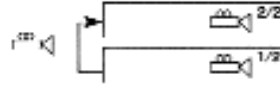

- You may only press the **ANGLE** button when the angle icon is flashing on the DVD display.
- Each time you press the **ANGLE** button, the angle will change.



#### Notes:

- ① The angle function will not work on DVD video discs that do not contain recorded multiple angles.
- ② During still playback, you are able to change the camera angle. However, when you resume to normal playback, the camera angle changes to the new settings.
- ③ The angle icon indicator will illuminate while playing back a title that contains at least one scene recorded from multiple angles.

#### 2. How to select a playback audio setting

This DVD player allows you to select a preferred language and sound recording system from those included on the DVD video disc.

1) Press the **AUDIO** button during playback.

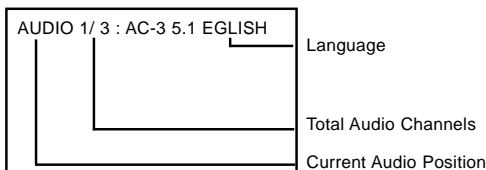

2) Press the **AUDIO** button again to cycle backwards.

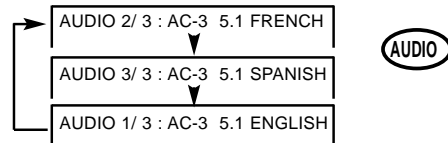

#### Recording systems

This DVD player uses the MPEG 2, PCM and DTS recording systems. It cannot playback DVD video discs recorded in any other recorded format.

#### Notes:

- ① The DVD player returns to the initial default settings when you turn on the DVD player or replace a disc.
- ② The DVD player plays the prior sound programmed on the disc when you select a format which is not included on the disc.

## DVD FUNCTIONS (continued)

### Playing in a Favorite Order

COMBINE YOUR FAVORITE TITLES, CHAPTERS, OR TRACKS AND PLAY THEM BACK IN ANY ORDER. PROGRAM UP TO 99 ITEMS INTO THE MEMORY. (PROGRAM PLAYBACK)

#### How to set titles, chapters, or tracks in a favorite order

The program playback function will automatically playback titles, chapters or tracks in the order preprogrammed.

1. Insert a disc during normal playback, press **STOP** the **STOP** twice, then press the **PROGRAM**



At this time, the menu will appear.

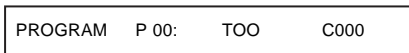

2. Using the numbered button, select the items in the order you want them programmed in.

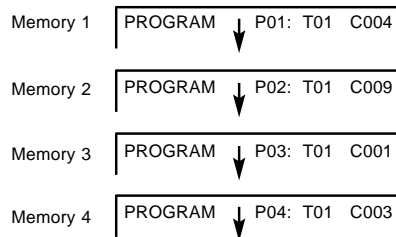

3. Press the OK button once to confirm. Press it again and playback begins.  
The DVD player starts memory playback.



**TO CHANGE the programmed item:**  
Press the **STOP** button, then press **PROGRAM**.

**TO CANCEL the programmed item:**  
Press the **STOP** button, then press **PROGRAM**, at last press **PLAY/PAUSE**

#### Notes:

- ① When the DVD player is turned off, or if the discs are removed, the program item will be removed.
- ② Depending on the disc, the program playback may not function.

## DVD FUNCTIONS (continued)

### Selecting Subtitles

THIS UNIT ALLOWS YOU TO DISPLAY THE SUBTITLES FROM THOSE INCLUDED ON THE DISC, ON TO YOUR TV SCREEN.

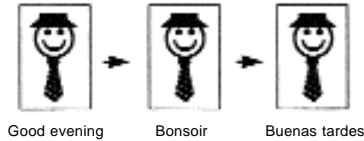

### How to display subtitles

You have the option to select a preferred subtitle from those included on the DVD video disc.

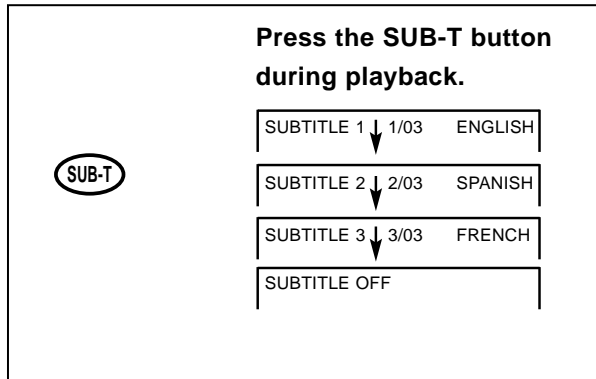

#### Notes:

- With some DVD's, you may not be able to turn off the subtitles and they will appear on screen automatically.
- As you press the SUB-T button, the subtitles may not appear immediately during some scenes.
- If the subtitles continue to show on your TV even after the DVD has been turned off, please refer to the TV's close caption settings.

### To TURN OFF the subtitles.

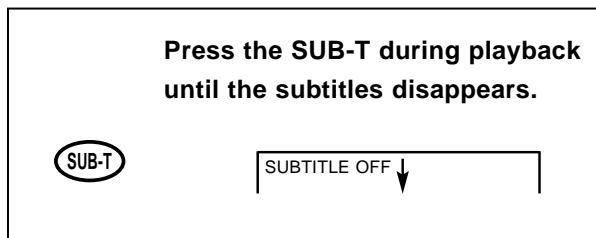

### Playing Repeatedly

THIS UNIT ALLOWS YOU TO PLAYBACK A SPECIFIC TITLE, CHAPTER, TRACK, OR SEGMENT REPEATEDLY. (TITLE REPEAT, CHAPTER/TRACK REPEAT).

#### How to repeat a title, chapter or track

1. Select the title, chapter, or track you want to repeat.

2. Press the REPEAT button.

The repeat mode changes each time you press the REPEAT button.

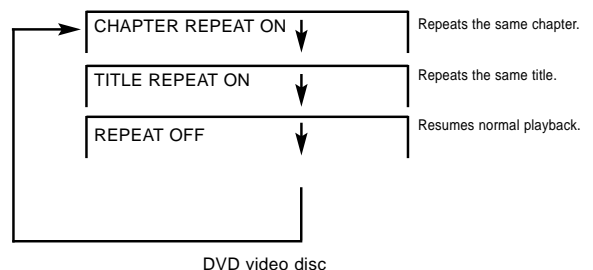

## DVD FUNCTIONS (continued)

### Playing Back Your KODAK Picture CD

#### 1. Normal

When a KODAK Picture CD is inserted, an automated slide show is launched. Each picture in the current directory will be displayed consecutively in a slide-show fashion and will be scaled to fit most of the TV screen. Twelve slideshow transition modes are provided. Use RESUME button to select: Customers can set "transition" effects for every picture at any time during the slideshow.

mode 0: no special transition effect (by default)

mode 1: wipe from top to bottom

mode 2: wipe from bottom to top

mode 3: wipe from top/bottom to center

mode 4: wipe from center to top/bottom

mode 5: vertical blind

mode 6: wipe from left to right

mode 7: wipe from right to left

mode 8: wipe from left/right to center

mode 9: wipe from center to left/right

mode 10: wipe from edge to center

mode 11: horizontal blinds

mode 12: random

To display an image indefinitely, press the **PAUSE** button. To view the Next or Previous picture press the **NEXT** or **PREV** button. To resume the slideshow press the **PLAY** button.

#### 2. Image rotation

There are four modes to transformation: "Invert", "Mirror", "Left", and "Right". These operations are allowed only when a picture is being displayed normally, and will be cancelled automatically when a new picture is displayed. The arrow buttons are used to select the different transformation modes:

UP ↑ -Invert / Normal

Down ↓ -Mirror / Normal

Left ← -Turn left

Right → -Turn right

#### 3. Menu

The **D-MENU** button is used to display thumbnail pictures. From the stop position, press the **D-MENU** button.

After it is enabled, up to nine scaled-down thumbnails pictures will be displayed on the screen. The **NEXT** and **PREV** buttons can be used to display the **NEXT** and **PREVIOUS** nine pictures in the current directory.

#### Note:

You can use the ↑/↓ / ←/→ / **OK** buttons to select.

## DVD FUNCTIONS (continued)

### Playing Your JPEG Files

#### 1. Normal Slide Show Presentation

When a JPEG disc is loaded into the player, a menu will appear on screen. From the Play Mode shown on the menu, select the "FOLDER" option using your direction buttons. Each picture in the current directory will be displayed consecutively in a slideshow presentation and will be seated to the most of your TV screen. Twelve slideshow "transition" modes are provided. Use **RESUME** button to select.

**Note:** From the playmode shown on the menu you may also select the "SINGLE" option to view a picture indefinitely until **NEXT**, **PREV**, or **PLAY** button is selected.

#### 2. Image rotation

There are four modes to rotate a picture: Invert, Mirror, Left, and Right. These operations are allowed only when a picture is being displayed normally, and will be cancelled automatically when a new picture is displayed. The arrow buttons are used to select the different rotation modes:

UP ↑ -Invert / Normal  
Down ↓ -Mirror / Normal  
Left ← -Turn left  
Right → -Turn right

#### 3. Zoom

This features allows you to view a picture at 25%-200% in several increments. Press the **ZOOM** button. An on screen message ("**Zoom On**") will verify your selection. Use **FWD** and **REV** buttons to control the amount of zoom in and out. Press the direction buttons to move the picture in any direction. With Zoom Off, the picture is scaled to fit most of your TV screen.

**Note:** When in the ZOOM mode, the slideshow transition and image transformation features are disabled.

#### 4. Menu

The **D-MENU** button is used to display thumbnail pictures. From the stop position, press the **D-MENU** button. After it is enabled, up to nine scaled-down thumbnails pictures will be displayed on the screen. The **NEXT** and **PREV** buttons can be used to display the **NEXT** and **PREVIOUS** nine pictures in the current directory. Each of the nine pictures are numbered from 1-9. By pressing a **Number** button, the corresponding picture will be enlarged to fill most your TV screen and the digest mode will be cancelled.

## DVD FUNCTIONS (continued)

### Using the On-Screen Display

THE UNIT ALLOWS YOU TO VIEW THE OPERATION STATUS AND DISC INFORMATION ON THE TV SCREEN.

#### Checking the operational status

With this function you can view the following on the TV:

- Current title
- Track number
- Total playing time

Press **DISPLAY** during playback

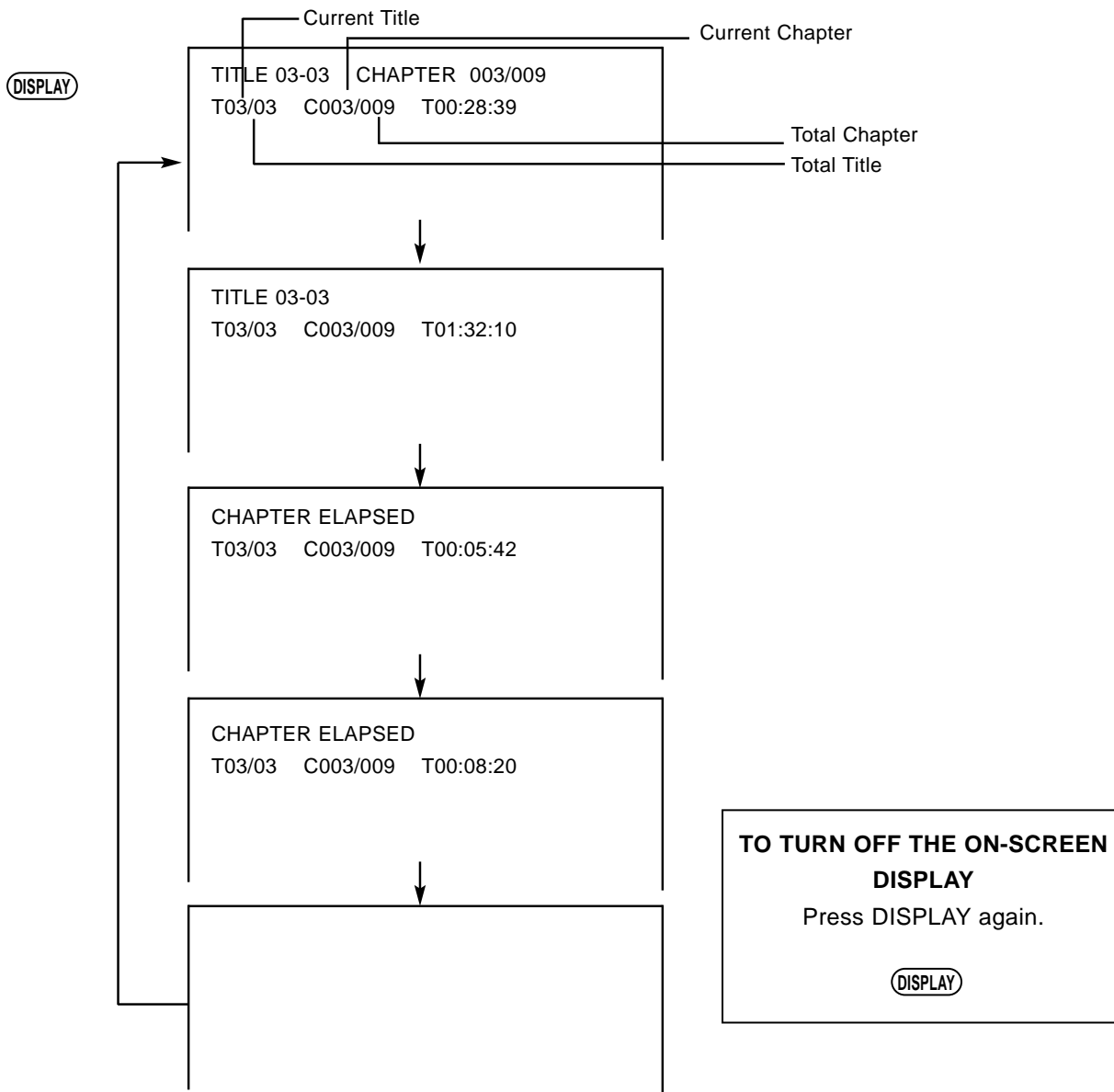

## DVD FUNCTIONS (continued)

### Setting the Parental Lock

YOU CAN USE THE PARENTAL LOCK FUNCTION ONLY WITH DVD VIDEO DISCS EQUIPPED WITH THE PARENTAL LOCK FEATURE.

#### Setting the parental lock

DVD video discs equipped with the parental lock function are rated according to their content. The contents allowed by a parental lock level and the way a DVD video disc can be controlled may vary from disc to disc. For example, if the disc allows, you can edit out violent scenes unsuitable for children and replace them with more suitable scenes, or lock out playback of the disc all together.

1. Press **STOP** during playback



Press **STOP** twice.

2. Press **SETUP**

The SETUP MENU appears on the TV screen.

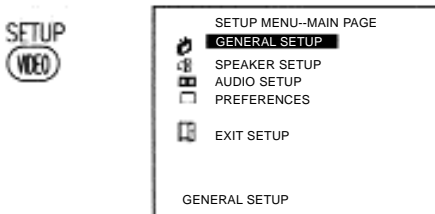

3. Select PREFERENCE using **↓** button then press **OK**.

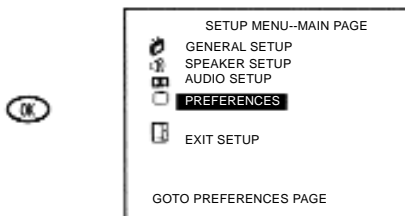

Note:

- In SETUP MENU, you can directly press **↑/↓/+/-** / **→/OK** to select.

4. Select PARENTAL, press **→**

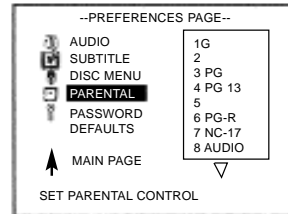

5. Select ratings, press **OK** button



6. Enter your password then pres **OK** button.  
The preset password is **3308**

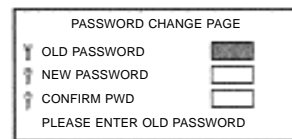

7. Press **SETUP** to exit setup, press **PLAY/PAUSE** to start

#### To change your password:

1. Follow step 4 to select password change.
2. Enter old password.
3. Enter new password.
4. Re-enter to confirm your new password.
5. Press **OK**.
6. Press **SETUP**.

## DVD FUNCTIONS (continued)

### Customizing the Function Settings

THIS UNIT ALLOWS YOU TO CUSTOMIZE THE PERFORMANCE TO YOUR PERSONAL PREFERENCES.

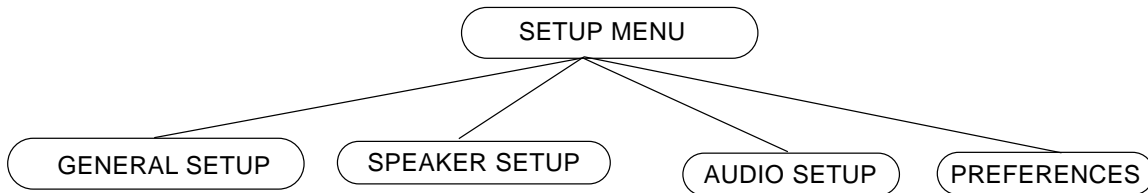

#### Displaying the setup menu screen

The SETUP MENU screen asks you to select a setting category from General Setup, Speaker Setup, Dolby Digital Setup, and Preferences. The selected category will provide you the setting details on-screen.

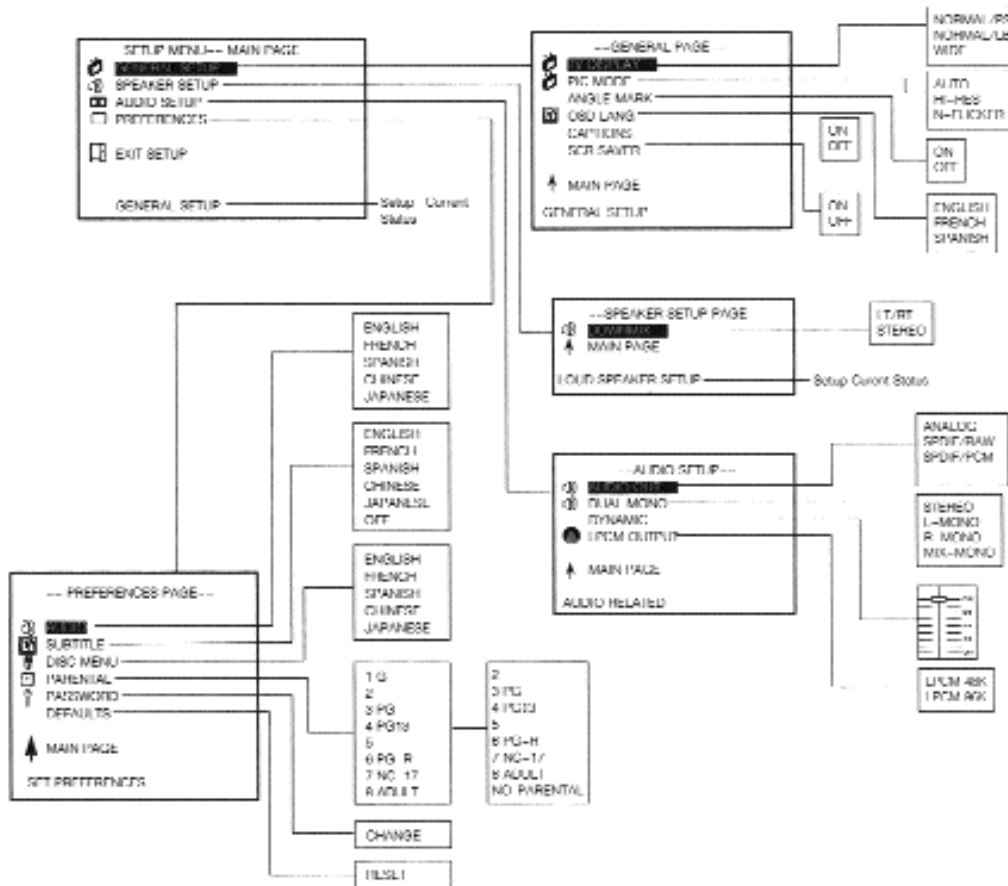

#### Notes:

- Preset password is 3308.
- Highlighted function will be expanded at bottom of the screen.
- The SETUP MENU screen disappears if you press the **SETUP** button while it is displayed.
- Functions and menu may change without notice.
- \* *Factory defaults*
- \* *You must press **STOP** twice to set up PREFERENCES.*



## SPECIFICATIONS

Television system:	NTSC-M
Singal system:	NTSC
Laser:	Semiconductor Laser, wavelength 650nm (DVD) 790nm (CD)
Channel coverage:	VHF 2~13 UHF 14~69 CABLE TV: MID BAND (A-8~A-1, A~I ) SUPER BAND (J~W) HYPER BAND (AA~ZZ, AAA, BBB) ULTRA BAND (65~94, 100~125)
Channels preset:	181
Antenna input:	75Ω (unbalanced)
Picture tube:	Effective screen dimensions: 478mm x 305mm (15.98 x 12.01 in. ) (Approx.)
Audio output:	2.5W+2.5W (THD ≤ 7%)
Power source:	~120Vac 60Hz
Weight:	27.7kg (60.94 lbs) (Approx. )
Dimensions (W / H / D):	512 x 522 x 510mm (20.16 x 20.55 x 20.08 in. ) (Approx.)
Packing dimensions (W / H / D):	614 x 634x 614mm (24.17 x 24.96x 24.17 in. ) (Approx.)
Rated power consumption:	~120W

Designs and specifications are subject to change without notice.

## TROUBLESHOOTING GUIDE

Check the following guide for a possible correction to a problem before contacting customer service.

Check FAQ at our website: [www.apexdigitalinc.com](http://www.apexdigitalinc.com).

### Symptoms and Correction

Symptoms	Correction
No power	<ul style="list-style-type: none"> <li>• Connect the power plug into the wall outlet securely.</li> </ul>
No picture	<ul style="list-style-type: none"> <li>• Verify the connection from the DVD/VCR video output to the TV video input is secure. Then switch TV to the appropriate Video mode.</li> <li>• Verify coaxial cable from antenna is connected to RF IN.</li> </ul>
No sound	<ul style="list-style-type: none"> <li>• Connect the audio cables into the terminals securely.</li> <li>• Verify the connection from the DVD/VCR audio output to the TV audio input. Then switch to the appropriate mode on the receiver. Refer to your audio amplifier owner's manual.</li> <li>• Mute feature may be enabled.</li> </ul>
No TV signal	<ul style="list-style-type: none"> <li>• Check whether your receiver is set to the TV mode.</li> <li>• Check whether the antenna is well connected to the TV receiver.</li> <li>• Unplug the TV from the wall for 30 seconds, then plug in and try again.</li> <li>• Unplug the antenna connection from the back of the TV, unplug the TV from the wall, wait 30 seconds, then try again.</li> </ul>
Stripe or purple interference appears in the screen.	<ul style="list-style-type: none"> <li>• Interference may come from high frequency sources such as a broadcasting station, poor ground connection in cable used, or non shielded audio speakers too close to the picture tube.</li> </ul>
Picture becomes snowy.	<ul style="list-style-type: none"> <li>• Check the antenna lead wire to see if it has open circuit or not.</li> <li>• Check the connection of antenna lead wire to the TV set input.</li> <li>• Check whether there is any damage to antenna.</li> </ul>
Picture with multi-image	<ul style="list-style-type: none"> <li>• Change the direction of antenna to minimize the multi image.</li> <li>• The video frequency radiated from TV station can be reflected by tall buildings, high tower, etc.</li> </ul>
TV channel not received	<ul style="list-style-type: none"> <li>• Make sure the Air/Cable setting is correct.</li> <li>• Channel may be locked with the block channel feature, such as Parental Control.</li> <li>• Check Add/Erase feature, as channel may have been erased during set up.</li> </ul>
Black box appears on screen.	<ul style="list-style-type: none"> <li>• Closed Caption to Text feature may be active.</li> </ul>
Remote control doesn't operate.	<ul style="list-style-type: none"> <li>• Batteries may be weak. Replace batteries.</li> <li>• Make sure remote sensor is not blocked including deflection from curved glass cabinet.</li> </ul>
Brightness is unstable or noises are produced on playback pictures	<ul style="list-style-type: none"> <li>• What you're viewing may be effect of the copy protection circuitry required on all DVD players. Change another disc, and try again.</li> </ul>
The DVD video player doesn't start playback	<ul style="list-style-type: none"> <li>• Place the disc with the graphics side up.</li> <li>• Place the disc on the disc tray correctly inside the guide.</li> <li>• Make sure the disc is free from scratches &amp; fingerprints.</li> <li>• Press the SETUP button to turn off the menu screen.</li> <li>• Cancel the parental lock function or change the parental lock level. (The preset password is 3308.)</li> <li>• Turn the power off then disconnect the power plug and reinsert it back into the wall. Retry again.</li> <li>• Use region 1 disc only.</li> </ul>
MP3 won't read disc or it skips	<ul style="list-style-type: none"> <li>• Reburn disc as the software edition used may not be compatible with the player. Check web site for instruction.</li> <li>• Use new editions of software such as Voyetra Audiostation 4, Adaptec's "Easy CD Creator" or NT 1. Roxio's Toast Titanium, etc.</li> <li>• Make sure MP3 file are not encoded with a variable bit rate such as provided by Real Networks.</li> </ul>

## TV/DVD Combo Warranty Information

---

### WHO IS COVERED?

Proof of purchase is required to receive warranty service such as the original sales receipt showing original date of purchase from an authorized Apex Digital, Inc. dealer in N. America. Keep your original box and packaging in case your unit needs to be shipped to us.

### WHAT IS COVERED?

Warranty repair from original date of purchase:

- **GT2015DV:** covered for 90 Days Labor. One (1) Year Replacement of Parts.

*If you don't have proof of purchase, your unit will be considered out-of-warranty & will be charged at a flat labor rate.*

### WHAT IS EXCLUDED?

Your warranty does not cover:

- Labor charges for installation or setup of the product, adjustment of customer controls on the product, and installation or repair of antenna systems outside of the product.
- Product repair and/or part replacement because of misuse, accident, unauthorized repair or other cause not within the control of Apex Digital, Inc. This includes the remote control.
- A product that requires modification or adaptation to enable it to operate in any country other than the country for which it was designed, manufactured, approved and/ or authorized, or repair of products damaged by these modifications.
- Incidental or consequential damages resulting from the product. (Some states do not allow the incidental or consequential damages, so the above exclusion may not apply to you. This includes, but is not limited to, prerecorded material, whether copyright 1 or not.)

### BEFORE REQUESTING SERVICE:

Check your owner's manual under "Troubleshooting Guide" and visit our website [www.apexdigitalinc.com](http://www.apexdigitalinc.com) for the latest updates under FAQ.

### ORDERING ACCESSORIES:

You may purchase a remote control (\$20 U.S. or \$35 in Canada), or owner's manual (\$7) directly from Apex Digital. Please send your model number, name & address along with a check made out to Apex Digital.

**MODEL #** \_\_\_\_\_ **SERIAL#** \_\_\_\_\_

### WHERE IS SERVICE AVAILABLE?

Please contact  
customer service: APEX DIGITAL, INC.  
2919 E. Philadelphia St., Ontario, CA 91761  
866-4APEXINC  
[www.apexdigitalinc.com](http://www.apexdigitalinc.com)

*This warranty gives you specific legal rights. You may have other rights-which vary from state/province to state/province.*

# Packing List

NO.	Parts	Quantities	Remarks
1	TV/DVD Combo	1	
2	Remote Control	1	
3	Operation Manual	1	
4	AAA Alkaline Batteries	2	

APEX Digital Inc.  
2919E.Philadelphia Street  
Ontario,CA 91761  
Tel: (909)930-0132  
[www.apexdigitalinc.com](http://www.apexdigitalinc.com)

