

KENWOOD

7V WIDE TOUCH SCREEN MONITOR

LZ-760R

INSTRUCTION MANUAL

Kenwood Corporation



Contents

Before Use	3	TV Control Function	14
Monitor Control Function	4	On Screen Control	
•Power Off		•Switching the Control Screen	
•Switching the Monitor's Picture		•Selecting the Preset Band	
•Volume		•Seek Mode	
•Switching the TV/Video Screen Mode		•Selecting the Channel	
•Switching the Speaker Mode		Control Screen	
•Switching the AV Output		•Selecting the Preset Band	
•Switching to the Screen Control Screen		•Seek Mode	
Screen Control Screen		•Selecting the Channel	
•Enter the Screen Control Screen		•Station Preset Memory	
•Adjusting the Picture Quality		•Auto Memory Entry	
•Auto Dimmer [Auto DIM]		•Recalling a Preset Station	
•Exit the Screen Control Screen		•Exit the Control Screen	
On Screen Control Mode			
•Switching the TV/Video Screen Mode		Installation	16
•Switching the Speaker Mode		Troubleshooting Guide	23
•Switching the AV Output		Specifications.....	24
•Exit the On Screen Mode			
Setup Function	8		
•Enter the Setup Menu Screen			
Setup Menu Screen			
•Setting the System Setup			
•Setting the TV Setup			
•Setting the Touch Panel Adjustment			
•Exit the Setup Menu Screen			
•Initializing the User Settings			
System Setup Screen-1			
•Setting the NAV input			
•Setting the AV-IN1 input			
•Setting the AV-IN2 input			
•Select the AV-IN2 input display			
•Touch Sensor Tone [BEEP]			
•Switching the Setup Screen-2			
•Exit the System Setup Screen-1			
System Setup Screen-2			
•Setting the AV Output [AV-OUT]			
•Switching the Setup Screen-1			
•Exit the System Setup Screen-2			
TV Area Setting Screen			
•Setting the TV Area			
•Exit the TV Area Setting Screen			
Touch Panel Adjustment Screen			
•Adjusting the Touch Position			

The illustrations of the display and the panel appearing in this manual are examples used to explain more clearly how the controls are used. Therefore, what appears on the display in the illustrations may differ from what appears on the display on the actual equipment, and some of the illustrations on the display may represent something impossible in actual operation.

Before Use

▲WARNING

To prevent injury and/or fire, take the following precautions:

- Ensure that the unit is securely installed. Otherwise it may fly out of place during collisions and other jolts.
- When extending the ignition, battery or ground wires, make sure to use automotive-grade wires or other wires with an area of 0.75mm² (AWG18) or more to prevent cable deterioration and damage to the cable coating.
- To prevent short circuits, never put or leave any metallic objects (e.g., coins or metal tools) inside the unit.
- If the unit starts to emit smoke or strange smells, turn off the power immediately and consult your Kenwood dealer.
- Do not touch the liquid crystal fluid if the LCD is damaged or broken due to shock. The liquid crystal fluid may be dangerous to your health or even fatal.
- If the liquid crystal fluid from the LCD contacts your body or clothing, wash it off with soap immediately.

▲CAUTION

To prevent damage to the machine, take the following precautions:

- Make sure to ground the unit to a negative 12V DC power supply.
- Do not open the top or bottom covers of the unit.
- Do not install the unit in a spot exposed to direct sunlight or excessive heat or humidity. Also avoid places with too much dust or the possibility of water splashing.
- Do not subject the faceplate to excessive shock, as it is a piece of precision equipment.
- When replacing a fuse, only use a new one with the prescribed rating. Using a fuse with the wrong rating may cause your unit to malfunction.
- To prevent short circuits when replacing a fuse, first disconnect the wiring harness.
- Do not use any screws except for the ones provided. The use of improper screws might result in damage to the main unit.
- You cannot view video pictures whilst the vehicle is moving. To enjoy TV/video pictures, find a safe place to park and engage the parking brake.

NOTE

- If you experience problems during installation, consult your Kenwood dealer.
- If the unit does not seem to be working right, try pressing the reset button first. If that does not solve the problem, consult your Kenwood dealer.

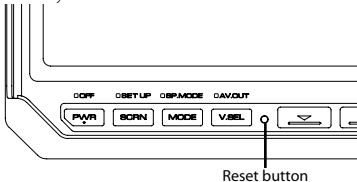

- Even if the Reset button is pressed, values set for individual items are not cleared. To initialize set values, perform the operation mentioned in <Initializing the User Settings> (page 8).

Cleaning the Unit

If the faceplate of this unit is stained, wipe it with a dry soft cloth such as a silicon cloth.

If the faceplate is stained badly, wipe the stain off with a cloth moistened with neutral cleaner, then wipe neutral detergent off.

▲CAUTION

Applying spray cleaner directly to the unit may affect its mechanical parts. Wiping the faceplate with a hard cloth or using a volatile liquid such as thinner or alcohol may scratch the surface or erase characters.

Screen brightness during low temperatures

When the temperature of the unit falls such as during winter, the liquid crystal panel's screen will become darker than usual. Normal brightness will return after using the monitor for a while.

Monitor Control Function

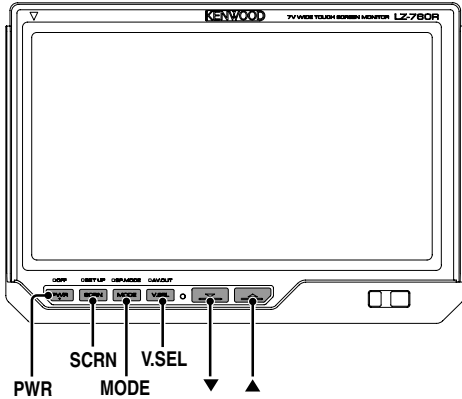

Power Off

Press the [PWR] button for at least 1 second.

Power On

Press the [PWR] button.

Switching the Monitor's Picture

Press the [V.SEL] button.

Each time the button is pressed the monitor's picture switches as follows:

During the KTC-V500N, KTC-V500P or KTC-V500E is not connected:

Display	Picture
"Video 1"	Video 1 (AV-IN1 setting during "Video 1")
"Video 2"/ "R-Cam"	Video 2 (AV-IN2 setting during "Video 2" or "R-Cam")
"NAV"	Navigation (NAV setting during "RGB" or "AV-IN1")

During the KTC-V500N, KTC-V500P or KTC-V500E is connected:

Display	Picture
"Video 1"	Video 1 (AV-IN1 setting during "Video 1")
"Video 2"/ "R-Cam"	Video 2 (AV-IN2 setting during "Video 2" or "R-Cam")
Channel	Television
"NAV"	Navigation (NAV setting during "RGB" or "AV-IN1")



- For "AV-IN" and "NAV" setting, refer to <System Setup Screen-1> (Page 9).
You cannot view television and video pictures whilst the vehicle is moving. To enjoy television and video pictures, find a safe place to park and engage the parking brake.

Volume

Increasing Volume:

Press the [▲] button.

Decreasing Volume:

Press the [▼] button.

Switching the TV/Video Screen Mode

Press the [MODE] button.

Each time the button is pressed the screen mode switches as follows:

Display	Setting
"Full"	Full screen mode
"Just"	Just screen mode
"Zoom"	Zoom screen mode
"Normal"	Normal screen mode



- You cannot operate when the navigation picture is displayed.

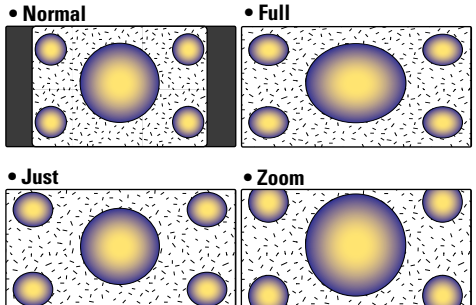

Switching the Speaker Mode

Press the [MODE] button for at least 1 second.

Each time the button is pressed for at least 1 second the built-in speaker mode switches as follows:

Display	Setting
"Normal"	Sound with monitor picture
"TV"	Sound of television (During the KTC-V500N, KTC-V500P or KTC-V500E is connected)
"NAV"	Sound of navigation
"Video1"	Sound of video 1
"Video2"/ "R-Cam"	Sound of video 2
"Off"	Built-in speaker is turned off

Switching the AV Output

Press the [V.SEL] button for at least 1 second.

Each time the button is pressed for at least 1 second the AV output switches as follows:

Display	Setting
"Normal"	Picture/sound with monitor picture
"TV"	Picture/sound of the television (During the KTC-V500N, KTC-V500P or KTC-V500E is connected)
"Video1"/ "NAV"	Picture/sound input from the AV-IN 1 terminal
"Video2"/ "R-Cam"	Picture/sound input from the AV-IN 2 terminal

Switching to the Screen Control Screen

Press the [SCRN] button.

(☛ Page 6)

Screen Control Screen

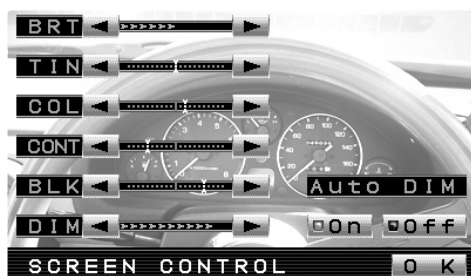

Enter the Screen Control Screen

Select the Screen Control mode by referring to "Switching to the Screen Control Screen" (page 5).

Adjusting the Picture Quality

Item	Touch	Setting
BRT	[▶] [◀]	Brighter screen Darker screen
TIN	[▶] [◀]	Stronger green level Stronger red level
COL	[▶] [◀]	Deeper color Paler color
CONT	[▶] [◀]	Stronger contrast Less contrast
BLK	[▶] [◀]	Less black level Stronger black level
DIM	[▶] [◀]	Brighter screen Darker screen



- The [TIN] and [COL] cannot be adjusted for the navigation picture or the control screen.
- The [TIN] cannot be adjusted for the picture of PAL.
- Separate picture quality settings can be stored for the television, video, control screens and navigation screens.

Auto Dimmer [Auto DIM]

Touch	Setting
[■On]	The [DIM] level can be adjusted. Also, when the area around the monitor is dark, the monitor brightness can be changed by the [DIM] level.
[■Off]	The [DIM] items can't be adjusted. Also, even if the area around the monitor is dark, it can't be changed from the brightness set by [BRT].

Exit the Screen Control Screen

Touch the [OK] button.

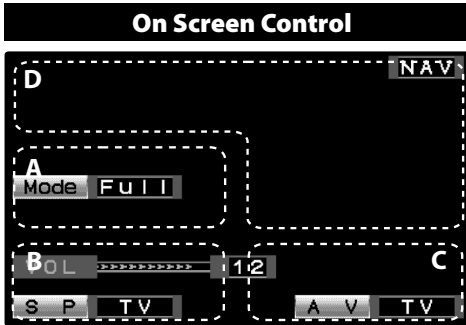

When the current setting information is displayed on the screen, touching a dotted line will enable operation of each of the following items:



- If R-Cam is selected when Mirror is set to ON for AV-IN2 (mentioned in <System Setup> (page 9)), On-screen settings are not displayed.

Switching the TV/Video Screen Mode

Touch the A area.

When buttons are displayed, touching the A area switches the Screen mode as follows:

Display	Setting
"Full"	Full screen mode
"Just"	Just screen mode
"Zoom"	Zoom screen mode
"Normal"	Normal screen mode



- You cannot operate when the navigation picture is displayed.

Switching the Speaker Mode

Touch the B area.

When buttons are displayed, touching the B area switches the built-in speaker mode as follows:

Display	Setting
"Normal"	Sound with monitor picture
"TV"	Sound of television (During the KTC-V500N, KTC-V500P or KTC-V500E is connected)
"NAV"	Sound of navigation
"Video1"	Sound of video 1
"Video2"/ "R-Cam"	Sound of video 2
"Off"	Built-in speaker is turned off

Switching the AV Output

Touch the C area.

When buttons are displayed, touching the C area switches the AV output mode as follows:

Display	Setting
"Normal"	Picture/sound with monitor picture
"TV"	Picture/sound of the television (During the KTC-V500N, KTC-V500P or KTC-V500E is connected)
"Video1"/ "NAV"	Picture/sound input from the AV-IN 1 terminal
"Video2"/ "R-Cam"	Picture/sound input from the AV-IN 2 terminal

Exit the On Screen Mode

Touch the D area.



- If you make no operation for 5 seconds, the On screen control mode is automatically canceled.

Setup Function

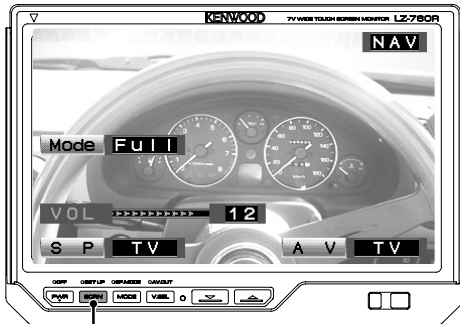

SCRN

Enter the Setup Menu Screen

Press the [SCRN] button for at least 1 second.
Setup Menu Screen is displayed.

Setup Menu Screen

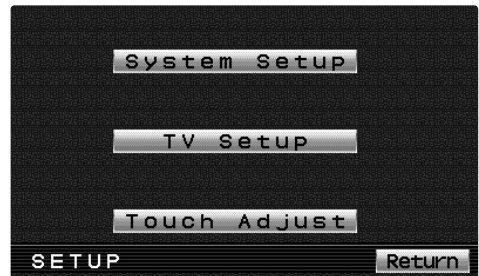

Setting the System Setup

Touch the [System Setup] button.
System Setup Screen-1 is displayed. (☛ Page 9)

Setting the TV Setup

Touch the [TV Setup] button.
TV Setup Screen is displayed. (☛ Page 11)
(During the KTC-V500P or KTC-V500E is connected)

Setting the Touch Panel Adjustment

Touch the [Touch Adjust] button.
Touch Panel Adjust Screen is displayed. (☛ Page 12)

Exit the Setup Menu Screen

Touch the [Return] button.



- If you cannot select a setup menu item. Press the [MODE] button for at least 1 second, the touch panel position settings are reset to the factory defaults.

Initializing the User Settings

When the Setup menu is displayed, pressing the [V.SEL] button for 1 second or longer restores the factory set default values for individual items from those set by the user.

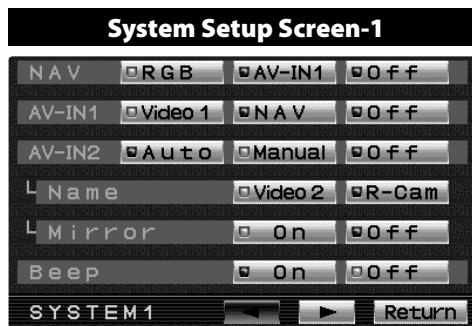

Setting the NAV input

Setup input and switch method of the navigation picture.

Touch	Setting
<input checked="" type="checkbox"/> [RGB]	It becomes the RGB mode setting. Operate the V.SEL button when the image from the navigation unit connected to I/F terminal is shown on the monitor.
<input type="checkbox"/> [AV-IN1]	It becomes the AV-IN1 mode setting. Operate the V.SEL button when the image from the navigation unit connected to AV-IN1 terminal is shown on the monitor.
<input type="checkbox"/> [Off]	It becomes the Off mode setting. Use this setting when there's nothing connected to the I/F terminal.

Setting the AV-IN1 input

Setup switch method of the picture input to AV-IN 1 terminal.

Touch	Setting
<input checked="" type="checkbox"/> [Video 1]	It becomes the video mode setting. Operate the V.SEL button when the image from the device connected to AV-IN1 terminal is shown on the monitor.
<input checked="" type="checkbox"/> [NAV]	It becomes the navigation mode setting. Operate the V.SEL button when the image from the navigation unit connected to AV-IN1 terminal is shown on the monitor.

<input type="checkbox"/> [Off]	It becomes the Off mode setting. Use this setting when there's nothing connected to the AV-IN1 terminal.
--------------------------------	--

Setting the AV-IN2 input

Setup switch method of the picture input to AV-IN 2 terminal.

Touch	Setting
<input checked="" type="checkbox"/> [Auto]	It becomes the auto video mode setting. When the video signal input to the AV-IN2 terminal, the monitor image is switched to the image of the device connected to the AV-IN2 terminal.
<input checked="" type="checkbox"/> [Manual]	It becomes the video mode setting. Operate the V.SEL button when the image from the device connected to AV-IN2 terminal is shown on the monitor.
<input checked="" type="checkbox"/> [Off]	It becomes the Off mode setting. Use this setting when there's nothing connected to the AV-IN2 terminal.

System Setup Screen-1



Select the AV-IN2 input display

Selecting the display when this device is switched to internal AV-IN2 terminal input source.

Touch the [Video 2] or [R-Cam] button.

Setting the Rear view camera image [Mirror]: (AV-IN2 setting during "R-Cam")

Touch	Setting
<input type="checkbox"/> On]	The image which appears in the camera is turned left-side right and displayed.
<input type="checkbox"/> Off]	The image which appears in the camera is displayed as it is.

Touch Sensor Tone [BEEP]

Setting the operation check sound (beep sound) ON/OFF.

Touch	Setting
<input type="checkbox"/> On]	Touch sensor tone is turned on.
<input type="checkbox"/> Off]	Touch sensor tone is turned off.

Switching the Setup Screen-2

Touch the [▶] button.

Exit the System Setup Screen-1

Touch the [Return] button.
Return to the setup menu screen.

System Setup Screen-2



Setting the AV Output [AV-OUT]

Touch	Setting
<input type="checkbox"/> Normal]	Picture/sound with monitor picture.
<input type="checkbox"/> Video 1]/ <input type="checkbox"/> NAV]	Picture/sound from AV-IN1 terminal.
<input type="checkbox"/> Video 2]/ <input type="checkbox"/> R-Cam]	Picture/sound from AV-IN2 terminal.
<input type="checkbox"/> TV]	Picture/sound from television. (During the KTC-V500N, KTC-V500P or KTC-V500E is connected)

Switching the Setup Screen-1

Touch the [◀] button.

Exit the System Setup Screen-2

Touch the [Return] button.
Return to the setup menu screen.



**Setting the TV Area
(During the KTC-V500E is connected)**

Select the area for TV broadcast viewing.

Selecting the Preset Bands:
Touch the [TV 1] or [TV 2] button.

Selecting the Reception Area:
Each time you touch the [◀] or [▶] button.
Select the channel setting for your country as follows.

G1	Austria, Denmark, Belgium, Finland, Germany, Iceland, Norway, Sweden, Switzerland, Netherlands, Spain, Portugal, Serbia and Montenegro	PAL-B/G
G2	Albania, Italy	PAL-B/G
G3	Ireland, United Kingdom	PAL-I
G4	France	SECAM
G5	Bulgaria, Czech, Hungary, Poland, Romania, Russia, Slovakia	SECAM -D/K
G6	Greece	SECAM -B/G



- The reception area can be set for two separate preset bands TV1 and TV2.

Exit the TV Area Setting Screen

Touch the [Return] button.
Return to the Setup menu screen.



- Pulling out the Connection cable to the TV tuner, settings of the TV Area will be default. Press the Reset button and set the TV Area again if the Connection cable is reconnected.

TV Area Setting Screen

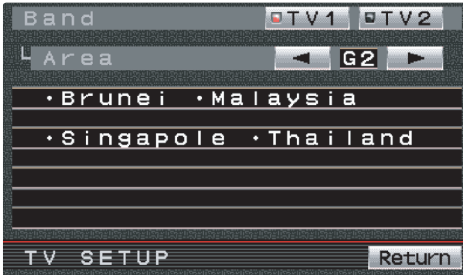

Setting the TV Area (During the KTC-V500P is connected)

Select the area for TV broadcast viewing.

Selecting the Preset Bands:

Touch the [TV 1] or [TV 2] button.

Selecting the Reception Area:

Each time you touch the [◀] or [▶] button.

Select the channel setting for your country as follows.

G1	China	PAL-D
G2	Brunei Malaysia Singapore Thailand	PAL-B/G
G3	Hong Kong	PAL-I
G4	Indonesia	PAL-B/G
G5	Australia	



- The reception area can be set for two separate preset bands TV1 and TV2.

Exit the TV Area Setting Screen

Touch the [Return] button.

Return to the Setup menu screen.



- Pulling out the Connection cable to the TV tuner, settings of the TV Area will be default. Press the Reset button and set the TV Area again if the Connection cable is reconnected.

Touch Panel Adjustment Screen

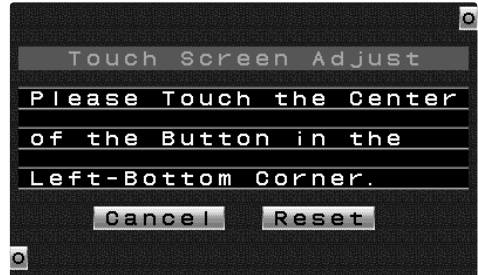

Adjusting the Touch Position

The touch panel can be adjusted if the position touched and the operation performed do not match.

- Accurately touch the mark at the lower left.
- Accurately touch the mark at the upper right.
When the mark at the upper right is touched, the adjustment is completed and the system setup menu screen reappears.



- If the [Cancel] button is touched without touching the button at the lower left, the adjustment is canceled and the screen goes back to the Setup Menu Screen.
- If the [Cancel] button is touched after touching the button at the lower left, the button at the lower left reappears.
- If the [Reset] button is touched, the settings are reset to the factory defaults and the setup menu screen reappears.

TV Control Function (During the KTC-V500N, KTC-V500P or KTC-V500E)

On Screen Control

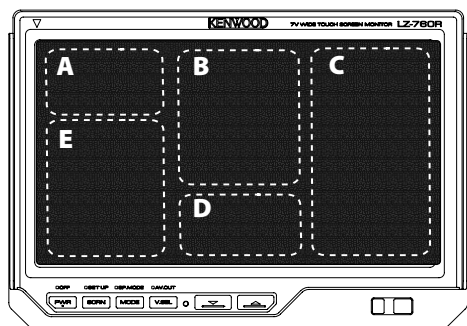

Control Screen

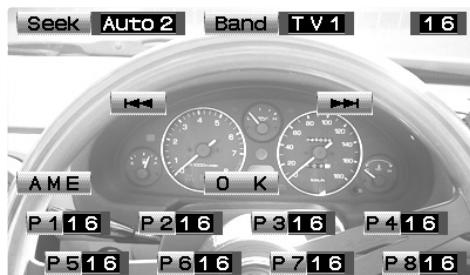

Switching the Control Screen

Touch the D area.



- If you make no button operation for 10 seconds, the control screen is automatically cancelled.

Selecting the Preset Band

Touch the B area.

Each time the B area is touched the preset band switches between the TV1 and TV2.



- If the button is not operated for 5 seconds, the Seek, Band, and Ch indications disappear automatically.

Seek Mode

Sets the seeking mode.

Touch the A area.

When the seek button is displayed, touching the A area switches the seeking mode as follows:

Seeking mode(display)	Operation
Auto seek ("Auto1")	Automatic search for a station.
Preset station seek ("Auto2")	Search in order of the stations in the Preset memory.
Manual ("Manual")	Normal manual seeking control.

Selecting the Channel

Touch the A, E or C area.

Selecting the Preset Band

Touch the [Band] button.

Each time the button is touched the preset band switches between the TV1 and TV2.

Seek Mode

Sets the seeking mode.

Touch the [Seek] button.

Each time the button is touched the seeking mode switches as shown below.

Seeking mode(display)	Operation
Auto seek ("Auto1")	Automatic search for a station.
Preset station seek ("Auto2")	Search in order of the stations in the Preset memory.
Manual ("Manual")	Normal manual seeking control.

Selecting the Channel

Touch the [◀◀] or [▶▶] button.

Station Preset Memory

Putting the station in the memory.

- 1 Select the band**
Touch the [Band] button.
- 2 Select the channel to put in the memory**
Touch the [◀◀] or [▶▶] button.
- 3 Put the channel in the memory**
Touch the [P1] — [P8] button for at least 1 seconds.
On each band, 1 station can be put in the memory on each [P1] — [P8] button.

Auto Memory Entry

Putting stations with good reception in the memory automatically.

- 1 Select the band for Auto Memory Entry**
Touch the [Band] button.
- 2 Open Auto Memory Entry**
Touch the [AME] button.
- 3 Do Auto Memory Entry**
Touch the [◀◀] or [▶▶] button.
When 8 stations that can be received are put in the memory Auto Memory Entry closes.



- If you make no button operation for 10 seconds, the Auto Memory Entry is automatically cancelled.

Recalling a Preset Station

- 1 Select the band**
- 2 Call up the station**
Touch the [P1] — [P8] button.

Exit the Control Screen

Touch the [OK] button.



- If you make no button operation for 10 seconds, the control screen is automatically cancelled.

Installation

Accessories

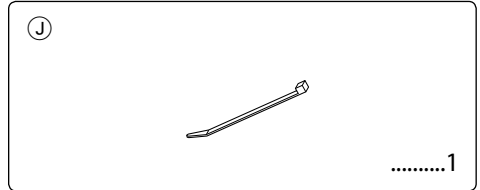
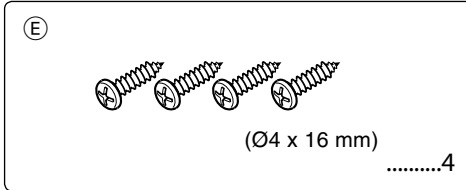
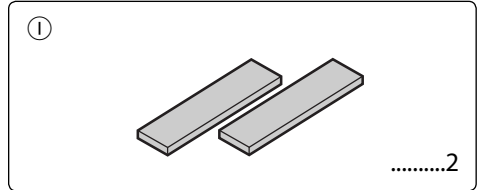
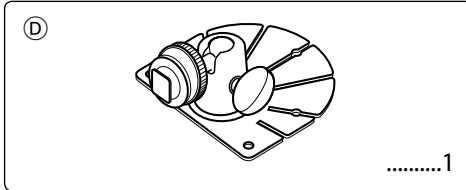
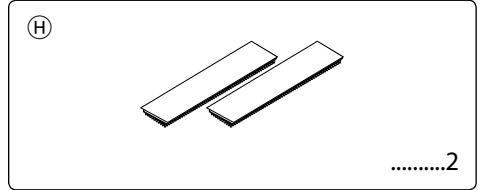
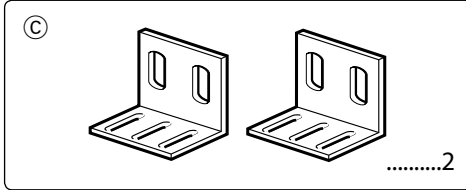
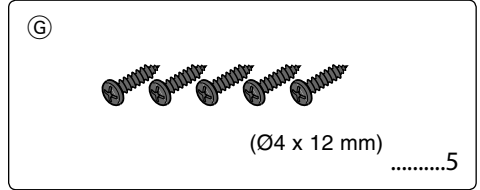
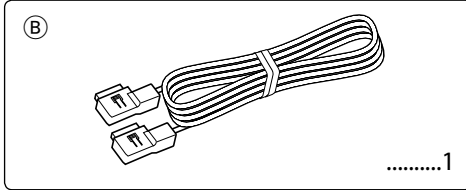
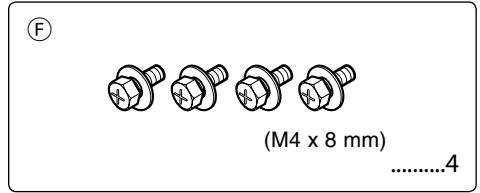
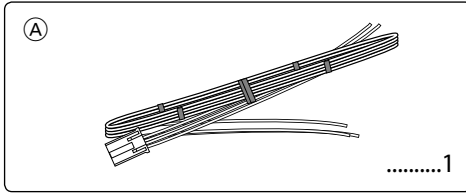

The use of any accessories except for those provided might result in damage to the unit. Make sure only to use the accessories shipped with the unit, as shown above.

Installation Procedure

1. To prevent short circuits, remove the key from the ignition and disconnect the ⊖ terminal of the battery.
2. Make the proper input and output cable connections for each unit.
3. Connect the wiring harness wires in the following order: ground, battery, ignition.
4. Connect the wiring harness connector to the unit.
5. Install the unit in your car.
6. Reconnect the ⊖ terminal of the battery.
7. Press the reset button. (See page 3)

⚠WARNING

- This product is intended for use with 12V DC negative ground power only. Do not connect it to any other power supply.
- To prevent shorting, disconnect the battery cable from the negative terminal of the battery during installation.
- Be sure to firmly stabilise this product. Do not install it in a location which is not stable.
- Follow the installation and wiring procedures described in this manual. Improper wiring or modified installation can not only result in malfunction or damage to the unit but may also result in an accident.
- **Do not install the unit in the following locations.**
 - A location which interferes with the operation of the air bag system.
 - A location which is not made of plastic.
 - ➔ Installing on leather, wood or cloth may damage the surface.
 - A location subject to direct sunlight, subject to the air from the air conditioner, or subject to moisture or high temperature.
 - ➔ This may cause deformation of the monitor unit.
- **Be sure to use the supplied screws for installation.** Using screws longer than those supplied may destroy parts inside the unit causing it to smoke. Using screws shorter than those supplied may cause the unit to come loose from the installation bracket.
- If you are not going to install the unit using the supplied monitor stand, be sure to use a commercially available monitor stand. (Mounting holes for such a stand are located on the bottom of the monitor unit.)



- If your car's ignition does not come with an ACC position, connect the ignition wires to a power source that can be turned on and off with the ignition key. If you connect the ignition wire to a power source that receives a constant voltage supply, as with battery wires, the battery may die.
- If the fuse blows, first make sure that the wires have not caused a short circuit, then replace the old fuse with one with the same rating.
- Do not let unconnected wires or terminals touch metal on the car or anything else conducting electricity. To prevent short circuits do not remove the caps from unused terminals or from the ends of the unconnected wires.
- After the unit is installed, check whether the brake lamps, blinkers, wipers, etc. on the car are working properly.
- Insulate unconnected wires with vinyl tape or other similar material.
- Thoroughly wipe away oil and other dirt from the installation surface.
Please avoid installation on uneven surfaces.
- Do not install the video box unit under the carpet. Otherwise heat build-up occurs and the unit may be damaged.

Connection

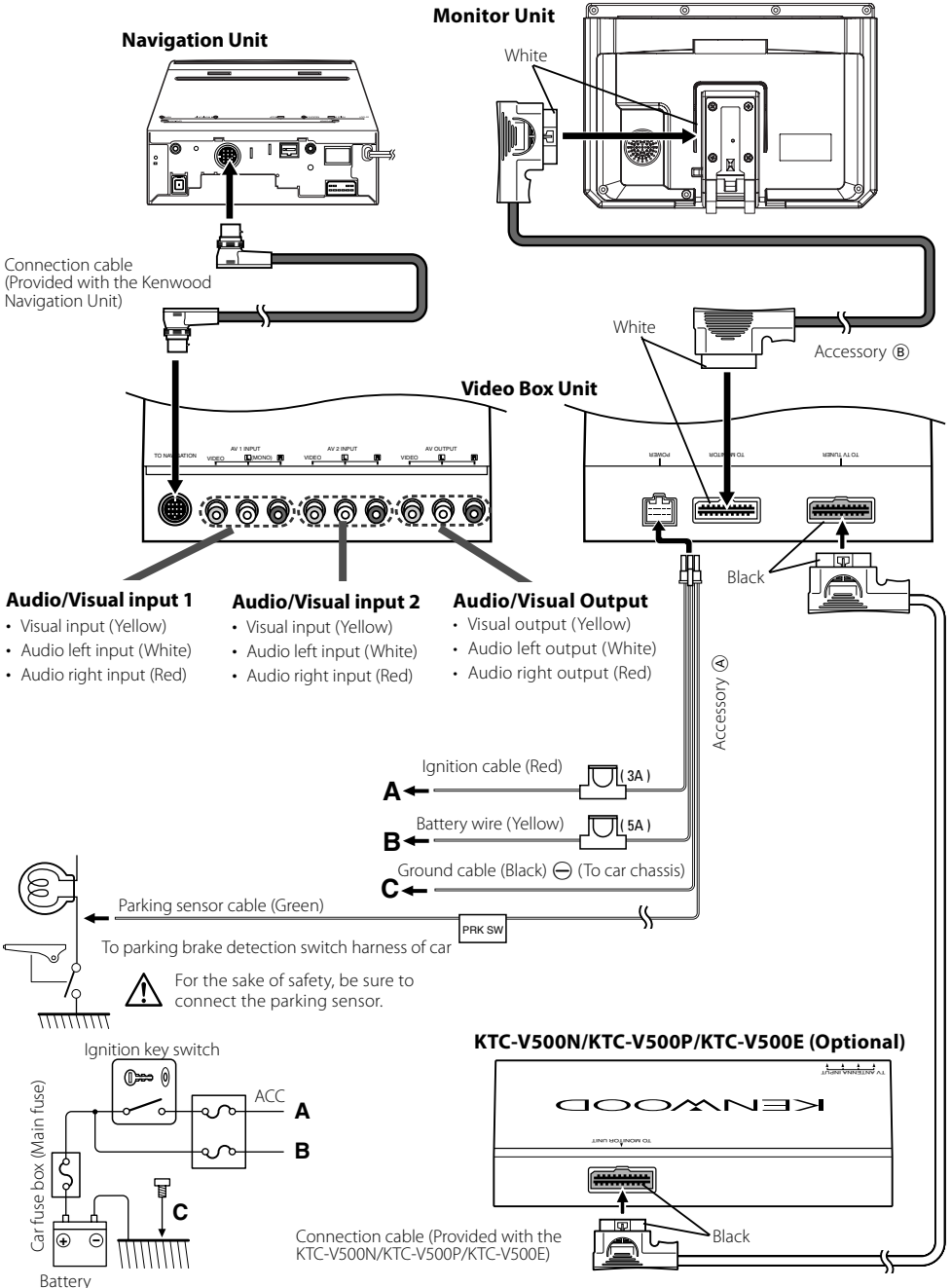

Installation for Monitor Unit

■ Installation location and cleaning

Select for installation a location where the stand can be placed completely horizontal or where the front edge of the support (petal-shaped part) can be attached horizontally as shown in Figure A. Do not install in locations where the entire support is at a diagonal such as in Figure B or where the monitor unit is facing down such as in Figure C.



- Thoroughly wipe away any dust or grease from the installation location using a cloth which has been soaked in a neutral cleaning agent and wrung out. Attach the stand after allowing the installation location to dry.

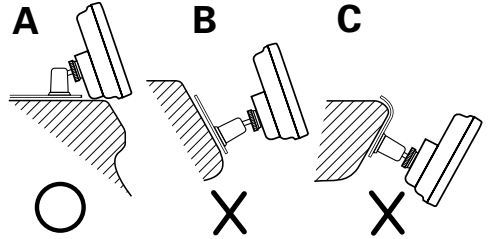

■ Affixing the Cushion

Affix the cushion to the monitor bracket.

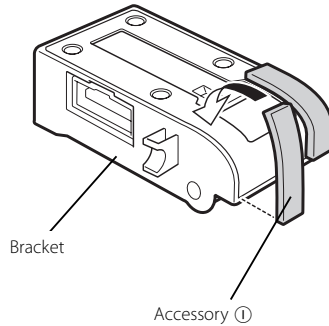

Installation for Monitor Unit

■ Setting the Monitor Unit

- 1 Bend the stand support to conform to the shape of the installation location.
- 2 Adjust the shape of the support so that there is no rattling or gap when the stand is placed on the support.
- 3 Peel off the protective strip from the double-sided tape on the bottom of the stand and securely attach the stand.



- Do not attach the double-sided tape more than once or touch the adhesive with your fingers as this will weaken its adhesive strength.
- If the temperature of the surface of the installation location is low, warm it up using a heater or other means before attaching the stand. Low temperature may weaken the adhesive strength of the tape.
- The supplied stand is specially intended for this product. Do not use it with another monitor.

- 4 Secure the stand (Accessory ①) using the supplied tapping screw (Accessory ②).
- 5 After attaching the stand, allow it to sit undisturbed for 24 hours.
- 6 Take care not to apply any force to the stand during this time.
- 7 Fully loosen the installation screws, align the slit on the rear of the unit with the installation shoe and slide the monitor unit onto the stand.
- 8 Adjust the height, horizontal angle and vertical angle of the monitor and securely tighten the installation screws.

You can also adjust the monitor unit's forward position by loosening the angle adjustment knobs and adjusting the angle of the monitor unit's installation stand.



- Attach the monitor to the bracket securely until it clicks.

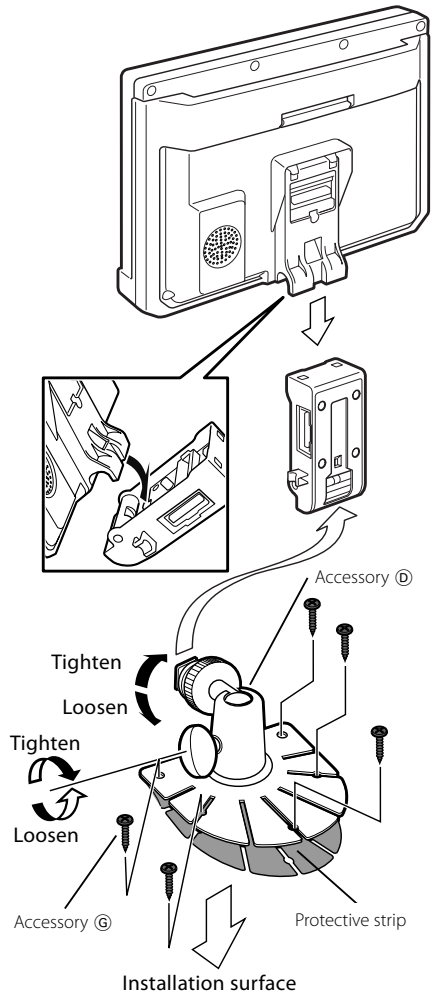

■ Attaching the Harness Band

Secure the cable to the bracket using the supplied harness band (Accessory ④).

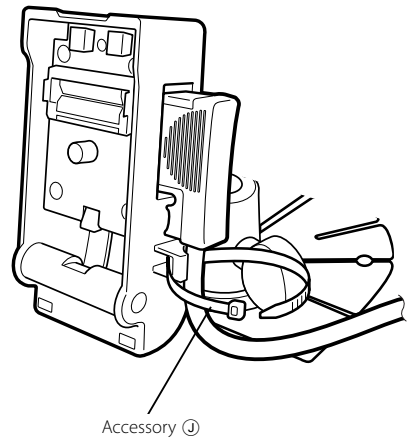

■ Removing the Monitor Unit

Raise the Release button.

The Monitor Unit is unlocked, allowing you to detach it.

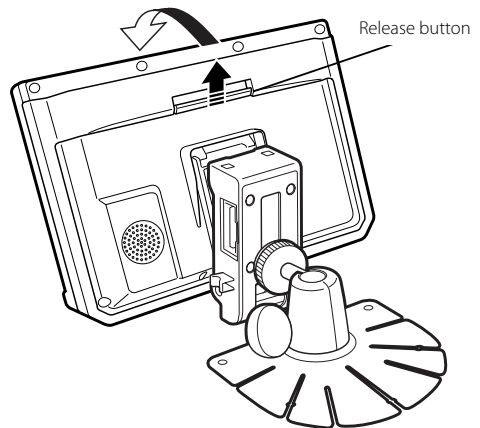

Installation for Video Box Unit

■ Securing to audio board

- 1 Use the screws (Accessory ⑥) to fix the bracket (Accessory ③) onto both sides of Video Box Unit.

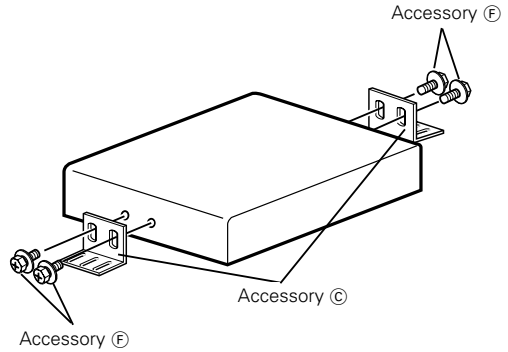

- 2 Use screws (Accessory ⑤) to fix Video Box Unit onto an audio board or another.

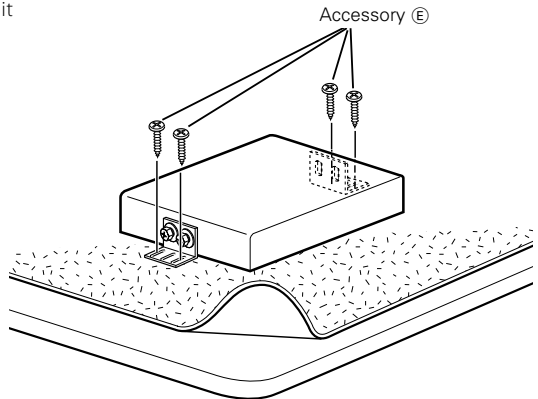

■ Securing to pile carpet

Peel the protective strips off of the velcro strips (Accessory ⑧), attach them to the bottom of the Video Box Unit, and secure to the pile carpet.



- Please do not install the unit near the dashboard, the rear tray, or other important components. Doing so could lead to injury or accident should the unit come off due to a shock and strike a person or an important component. Tapping screws should be used for mounting. (Attachment with velcro strips, although easy, can come off with a shock.)

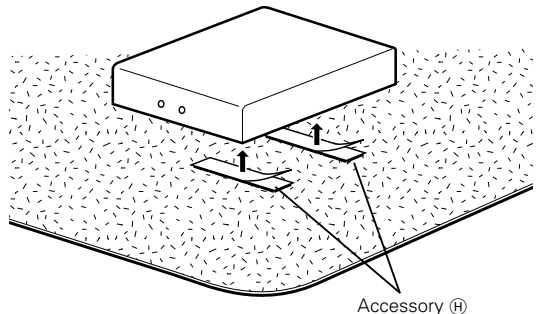

Troubleshooting Guide

What might appear to be a malfunction in your unit may just be the result of slight misoperation or miswiring. Before calling service, first check the following table for possible problems.

General

? The power does not turn ON.

- ✓ The fuse has blown.
 - ☞ After checking for short circuits in the wires, replace the fuse with one with the same rating.
- ✓ The motor is not attached to the bracket securely.
 - ☞ Attach the motor to the bracket until it clicks.

? Nothing happens when the buttons are pressed.

- ✓ The computer chip in the unit is not functioning normally.
 - ☞ Press the reset button on the unit (page 3).

? The screen is dark.

- ✓ The unit is in a location where temperature is low.
 - ☞ If the temperature of the monitor unit drops, the screen may appear darker when power is first turned on due to the characteristics of a liquid crystal panel. Wait a while after turning power on for the temperature to rise. Normal brightness will return.
- ✓ The BRT, BLK, CONT, and other screen control levels are too low.
 - ☞ Adjust the BRT, BLK, CONT, and other screen controls to obtain appropriate illumination, or restore them to factory-set levels with reference to <Initializing the User Settings> (page 8).

Specifications

Specifications subject to change without notice.

Monitor Unit

Screen size	7.0 inches wide 154.1(W) x 87.0(H) x 177.0(Diagonal) mm 6-1/16(W) x 3-7/16(H) inches
Display system	Transparent TN LCD panel
Drive system	TFT active matrix system
Number of pixels	336,960 pixels (480 H x 234 V x RGB)
Effective pixels	99.99%
Pixel arrangement	RGB striped arrangement
Back lighting	Cold cathode tube
Speaker power	0.5 W (40 x 20 mm x 1)

Video Box Unit

Colour system	NTSC/PAL
External video input level (RCA jacks)	1 ± 0.1 Vp-p/ 75 Ω
External audio input level (RCA jacks)	1 V/ 55 KΩ
Video output level (RCA jacks)	1 ± 0.1 Vp-p/ 75 Ω
Audio output level (RCA jacks)	1 V/ 1 KΩ
Analogue RGB input	0.7 Vp-p/ 75 Ω

General

Operating voltage	14.4 V DC (11 - 16 V)
Consumed Power	14 W
Operational temperature range	-10°C to +60°C
Storage temperature range	-30°C to +80°C
Size	
(Monitor unit)	178(W) x 125(H) x 37(D) mm 7(W) x 4-15/16(H) x 1-7/16(D) inches
(Video box unit)	188(W) x 30(H) x 144(D) mm 7-3/8(W) x 1-3/16(H) x 5-11/16(D) inches
Mass	
(Monitor unit)	540 g(1.19 LBS)
(Video box unit)	680 g(1.50 LBS)

Although the effective pixels for the liquid crystal panel is given as 99.99% or more, 0.01% of pixels may not light or may light incorrectly.