



INSTRUCTIONS

Model

GD-V4200PZW

GD-V4200PZW-G

GD-V4200PCE

GD-V4200PCE-G

*Thank you for purchasing this JVC Monitor.
 Before using the monitor, read this manual carefully so that you know how to use the Monitor correctly.
 Refer to this manual whenever questions or problems about operation arise. Be sure to read and observe the safety precautions.
 Keep this manual where the user can see it easily.
 * Installation and removal require special expertise.
 Consult your product dealer for details.*

ENGLISH

This instruction manual refers to the GD-V4200PZW, GD-V4200PZW-G, GD-V4200PCE and GD-V4200PCE-G. The explanations and illustrations used in this instruction manual are of the GD-V4200PZW unless otherwise stated. The differences between each model are as follows:

| | | GD-V4200PZW | GD-V4200PZW-G | GD-V4200PCE | GD-V4200PCE-G |
|--------------|-----------|-------------|---------------|-----------------------------|---------------|
| Frame Colour | | Silver | Gray | Silver | Gray |
| Inputs | VIDEO A | Available | | Not available* ¹ | |
| | VIDEO B | Available | | Not available* ¹ | |
| | COMPONENT | Available | | Not available* ¹ | |
| | RGB AUDIO | Available | | Not available* ¹ | |

*¹ These inputs will be available with the separately-purchased video interface kit (IF-C420P1W). Ask your dealer to install the video interface kit.

Contents

| | Page | | Page |
|---|------|--|------|
| Safety Precautions | 2 | Other Convenient Functions | 20 |
| Parts Identification | 4 | • Showing On-screen Display | 20 |
| • Remote Control | 4 | • Confirming the Use Time | 21 |
| • Monitor: Front View | 5 | • Setting the Power Saving Function | 21 |
| • Monitor: Rear View | 6 | • Prohibiting the Monitor's Button Operations | 21 |
| Preparations | 8 | • Reducing the Afterimage Effect | 22 |
| • Checking the Accessories | 8 | • Showing the On-screen When Changing the Input Mode | 22 |
| • Installing the Batteries | 8 | • Using the Screen Saver Function | 23 |
| Installation | 9 | • Mounting the Monitor Vertically | 23 |
| • Precautions | 9 | • Resetting All the Setup Menu Settings | 23 |
| Connections | 10 | Serial Connections and Operations | 24 |
| • Precautions | 10 | • Connecting the Remote Control Cables | 24 |
| • Available Signals | 10 | • Assigning ID Numbers | 24 |
| • Connection Examples | 11 | • Operating the Monitors Simultaneously | 25 |
| Basic Operations | 12 | • Operating the Monitors Individually | 25 |
| • Daily Operations | 12 | Menu Classifications | 26 |
| • Changing the Aspect Ratio | 13 | • Main Menu | 26 |
| Video Adjustments | 14 | • Setup Menu | 27 |
| • Adjusting the Screen Size and Position (For RGB input only) | 14 | Troubleshooting | 28 |
| • Adjusting the Picture Quality | 15 | • Self-diagnostic Indication | 29 |
| • Adjusting the Color Temperature | 16 | Specifications | 30 |
| • Adjusting the White Balance | 17 | | |
| • Changing the Aspect Ratio | 18 | | |
| • Setting the Receivable Signal Types | 19 | | |
| • Resetting the Function Selection Menu Settings .. | 19 | | |

Safety Precautions

FCC NOTICE

This equipment has been tested and found to comply with the limits for a Class B digital device, pursuant to Part 15 of the FCC Rules. These limits are designed to provide reasonable protection against harmful interference in a residential installation. This equipment generates, uses, and can radiate radio frequency energy and, if not installed and used in accordance with the instructions, may cause harmful interference to radio communications. However, there is no guarantee that interference will not occur in a particular installation. If this equipment does cause harmful interference to radio or television reception, which can be determined by turning the equipment off and on, the user is encouraged to try to correct the interference by one or more of the following measures:

- Reorient or relocate the receiving antenna.
- Increase the separation between the equipment and receiver.
- Connect the equipment into an outlet on a circuit different from that to which the receiver is connected.
- Consult the dealer or an experienced radio/TV technician for help.

Caution: Changes or modifications not approved by JVC could void the user's authority to operate the equipment.

IMPORTANT INFORMATION

WARNING: TO REDUCE THE RISK OF FIRE AND ELECTRIC SHOCK, DO NOT EXPOSE THIS PRODUCT TO RAIN OR MOISTURE.

IMPORTANT SAFEGUARDS

Electrical energy can perform many useful functions. This unit has been engineered and manufactured to assure your personal safety. But **IMPROPER USE CAN RESULT IN POTENTIAL ELECTRICAL SHOCK OR FIRE HAZARD**. In order not to defeat the safeguards incorporated into this product, observe the following basic rules for its installation, use and service. Please read these "Important Safeguards" carefully before use.

- All the safety and operating instructions should be read before the product is operated.
- The safety and operating instructions should be retained for future reference.
- All warnings on the product and in the operating instructions should be adhered to.
- All operating instructions should be followed.
- Unplug this product from the wall outlet before cleaning. Do not use liquid cleaners or aerosol cleaners. Use a damp cloth for cleaning.
- Do not use attachments not recommended by the product manufacturer as they may be hazardous.
- Do not use this product near water. Do not use immediately after moving from a low temperature to high temperature, as this causes condensation, which may result in fire, electric shock, or other hazards.
- Do not place this product on an unstable cart, stand, or table. The product may fall, causing serious injury to a child or adult, and serious damage to the product. The product should be mounted according to the manufacturer's instructions, and should use a mount recommended by the manufacturer.
- When the product is used on a cart, care should be taken to avoid quick stops, excessive force, and uneven surfaces which may cause the product and cart to overturn, damaging equipment or causing possible injury to the operator.



- Slots and openings in the cabinet are provided for ventilation. These ensure reliable operation of the product and protect it from overheating. These openings must not be blocked or covered. (The openings should never be blocked by placing the product on bed, sofa, rug, or similar surface. It should not be placed in a built-in installation such as a bookcase or rack unless proper ventilation is provided and the manufacturer's instructions have been adhered to.)

For proper ventilation, separate the product from other equipment, which may prevent ventilation and keep distance more than 10 cm (3 ¹⁵/₁₆ inches).

- This product should be operated only with the type of power source indicated on the label. If you are not sure of the type of power supply to your home, consult your product dealer or local power company.
- This product is equipped with a three-wire plug. This plug will fit only into a grounded power outlet. If you are unable to insert the plug into the outlet, contact your electrician to install the proper outlet. Do not defeat the safety purpose of the grounded plug.
- Power-supply cords should be routed so that they are not likely to be walked on or pinched by items placed upon or against them. Pay particular attention to cords at doors, plugs, receptacles, and the point where they exit from the product.
- For added protection of this product during a lightning storm, or when it is left unattended and unused for long periods of time, unplug it from the wall outlet and disconnect the cable system. This will prevent damage to the product due to lightning and power line surges.
- Do not overload wall outlets, extension cords, or convenience receptacles on other equipment as this can result in a risk of fire or electric shock.
- Never push objects of any kind into this product through openings as they may touch dangerous voltage points or short out parts that could result in a fire or electric shock. Never spill liquid of any kind on the product.
- Do not attempt to service this product yourself as opening or removing covers may expose you to dangerous voltages and other hazards. Refer all service to qualified service personnel.
- Unplug this product from the wall outlet and refer service to qualified service personnel under the following conditions:
 - a) When the power supply cord or plug is damaged.
 - b) If liquid has been spilled, or objects have fallen on the product.
 - c) If the product has been exposed to rain or water.
 - d) If the product operated normally by following the operating instructions. Adjust only those controls that are covered by the Operation Manual, as an improper adjustment of controls may result in damage and will often require extensive work by a qualified technician to restore the product to normal operation.
 - e) If the product has been dropped or damaged in any way.
 - f) When the product exhibits a distinct change in performance – this indicates a need for service.
- When replacement parts are required, be sure the service technician has used replacement parts specified by the manufacturer or with same characteristics as the original part. Unauthorized substitutions may result in fire, electric shock, or other hazards.
- Upon completion of any service or repairs to this product, ask the service technician to perform safety checks to determine that the product is in proper operating condition.
- The product should be placed more than 30 cm (11 ¹⁵/₁₆ inches) away from heat sources such as radiators, heat registers, stoves, and other products (including amplifiers) that produce heat.
- When connecting other products such as VCR's, and personal computers, you should turn off the power of this product for protection against electric shock.
- Do not place combustibles behind the cooling fan. For example, cloth, paper, matches, aerosol cans or gas lighters that present special hazards when over heated.
- Use only the accessory cord designed for this product to prevent shock.

Parts Identification

Remote Control

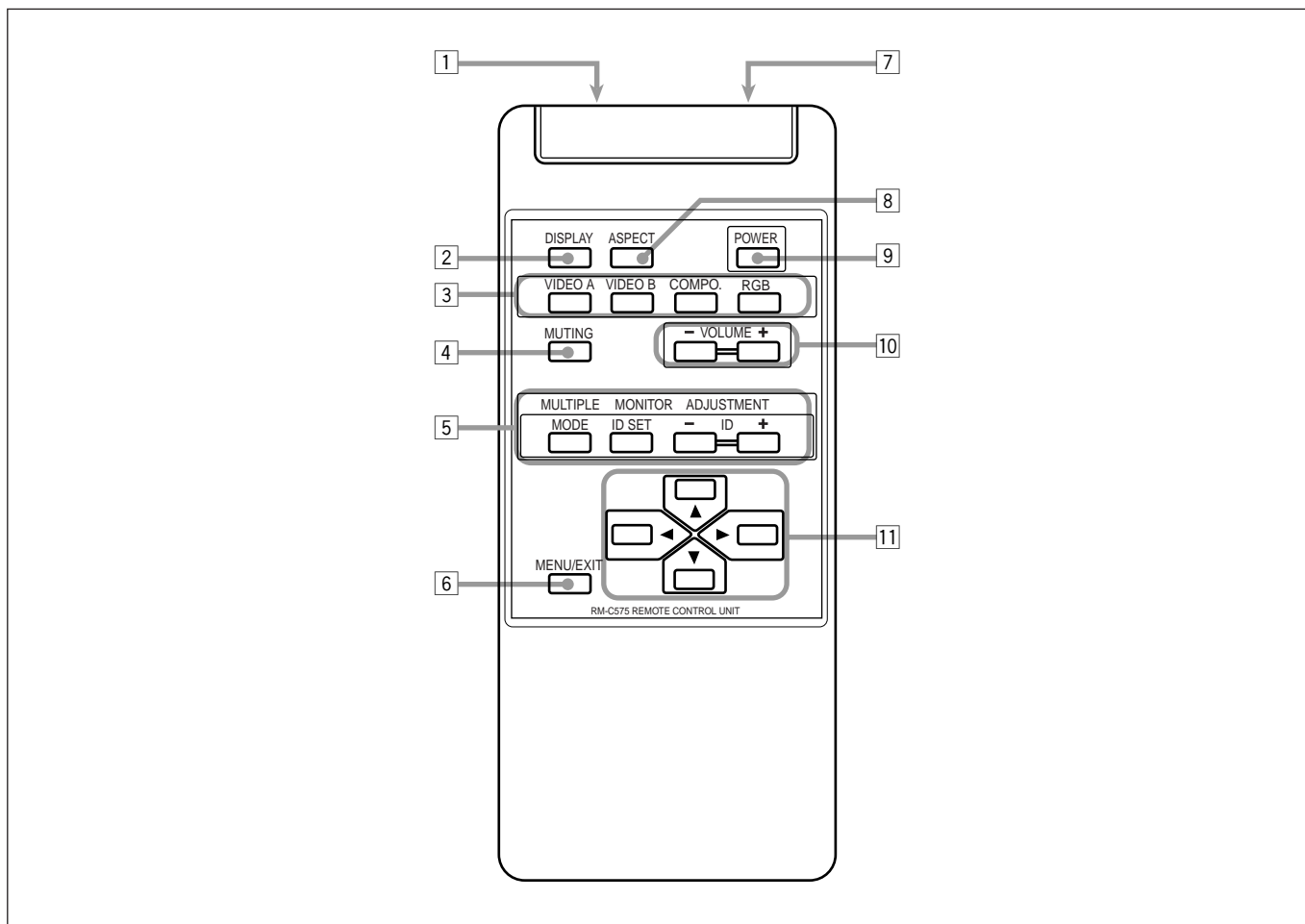

1 Remote signal transmission window

2 DISPLAY button (page 12)

Use this button to display the input terminal, color system (for VIDEO A or B input), scan system (for COMPONENT input) and horizontal/vertical frequency (for RGB input). Pressing the button again will make the display disappear.

3 VIDEO A, VIDEO B, COMPO. and RGB buttons (page 12)

Use these buttons to switch between inputs.

- Only for GD-V4200PCE and GD-V4200PCE-G: Only RGB input can be reproduced. Though you can switch to the other inputs, the images will not be reproduced. To reproduce images through the other inputs, you need to install video interface kit (IF-C420P1W), which is separately purchased.

4 MUTING button (page 12)

Use this button to turn off the volume immediately. Pressing the button again will resume the previous volume level.

5 MULTIPLE MONITOR ADJUSTMENT buttons (page 24)

Use these buttons to set IDs, etc. when serial connection is made.

6 MENU/EXIT button

Use this button to display or erase menus. While a sub-menu is displayed, pressing this button will move you one screen back to the preceding menu.

7 Remote control cable jack (page 24)

Connect the remote control cable when using this remote control as a wired remote control.

8 ASPECT button (page 13)

Use this button to switch between aspect ratios. Each time you press the button, the aspect ratio changes as follows:

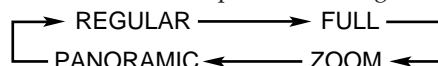

9 POWER button (page 12)

Use this button to turn on/off the power.

10 VOLUME + / - buttons (page 12)

Use these buttons to adjust the volume level.

- Only for GD-V4200PCE and GD-V4200PCE-G: Though you can use these buttons, sound will not be reproduced. To reproduce the sound, you need to install video interface kit (IF-C420P1W), which is separately purchased.

11 ◀ / ▶ / ▲ / ▼ buttons

Use these buttons to select menu items or make adjustments.

Monitor: Front View

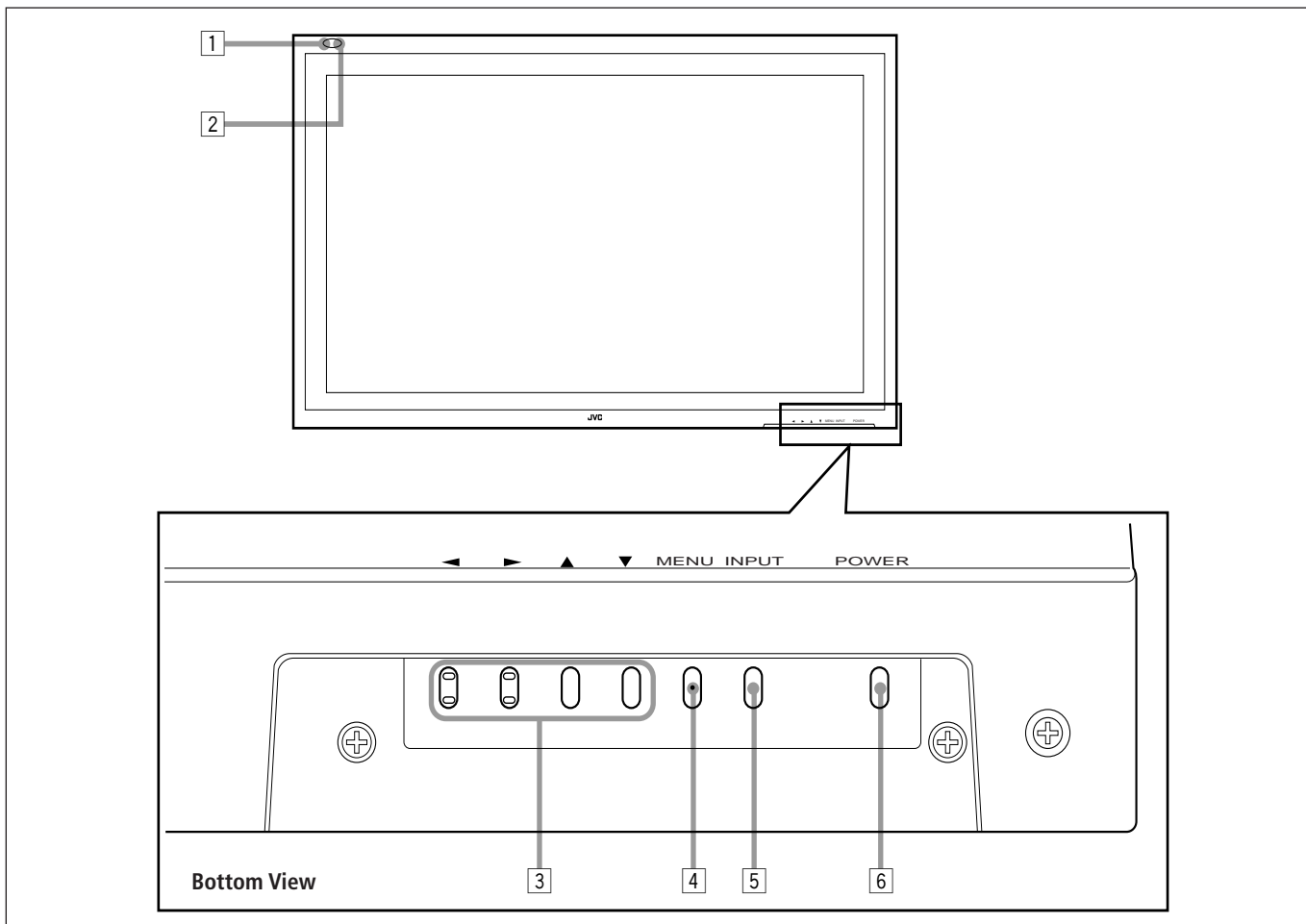

- 1 Remote sensor/power lamp**
 Point the front end of the wireless remote control toward here.
 When the Monitor is turned on, the power lamp glows green. It glows red in standby mode.
- 2 Self-diagnostic lamps (page 29)**
 These lamps light/flash if something abnormal occurs with the Monitor.
- 3 ◀ / ▶ / ▲ / ▼ buttons**
 Use these buttons to select menu items and to make adjustments.

 - When no menu is displayed, you can use the ▲ / ▼ buttons to adjust the volume level.
- 4 MENU button**
 Use this button to display or erase menus.
 While a sub-menu is displayed, pressing this button will move you one screen back to the preceding menu.
- 5 INPUT button (page 12)**
 Use this button to switch between inputs.

 - Only for GD-V4200PCE and GD-V4200PCE-G: Only RGB input can be reproduced. Though you can switch to the other inputs, the images will not reproduced. To reproduce images through the other inputs, you need to install video interface kit (IF-C420P1W), which is separately purchased.
- 6 POWER button (page 12)**
 Use this button to turn on and off the Monitor.

Parts Identification (Continued)

Monitor: Rear View

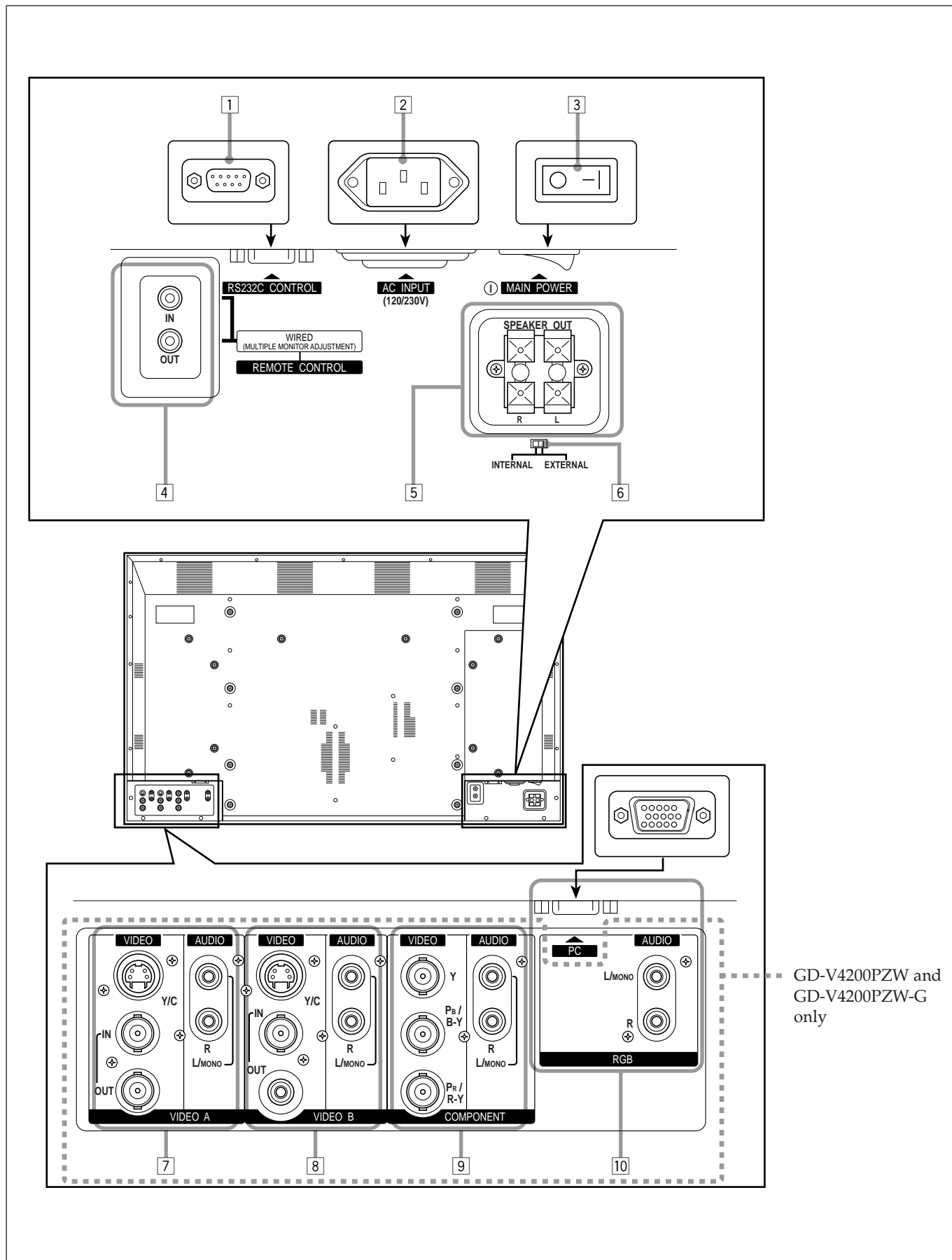

1 RS-232C CONTROL Input terminal (D-sub, 9-pin) (page 11)

Connect this terminal to the RS-232C terminal of a personal computer.

- For the control method using this terminal, consult an authorized JVC dealer.

2 AC INPUT terminal (page 11)

Connect the supplied power cord to this terminal.

3 MAIN POWER switch (page 12)

Setting this switch to ON will put the Monitor into standby mode, allowing you to turn on and off the power using the POWER button either on the remote control or on the Monitor.

4 REMOTE CONTROL terminals (mini jack) (page 24)**• IN**

For Master Monitor: Connect a wired remote control to this terminal for serial connection.

For Slave Monitors: Connect to the REMOTE CONTROL OUT terminal of another Monitor in serial connection.

• OUT

Connect to the REMOTE CONTROL IN terminal of another Monitor for serial connection.

5 SPEAKER OUT terminals (page 11)

Connect external speakers.

6 INTERNAL/EXTERNAL (built-in speaker/external speaker) selecting switch (page 11)

INTERNAL: To use built-in speakers.

EXTERNAL: To use external speakers.

7 VIDEO A terminals (page 11)*

- Y/C (S video) input terminal (Y/C terminal)
Connect this terminal to the S-video output terminal of a VCR, etc.
- Video input terminal (BNC)
Connect this terminal to the video output terminal of a VCR, etc. You can also use it as a video output terminal.
- Video output terminal (BNC)
Connect this terminal to the video input terminal of another Monitor. You can also use it as a video input terminal.
- Audio input terminals (pin jack)
Connect these terminals to the audio input terminals of a VCR, etc.

8 VIDEO B terminals (page 11)*

- Y/C (S video) input terminal (Y/C terminal)
Connect this terminal to the S-video output terminal of a VCR, etc.
- Video input terminal (BNC)
Connect this terminal to the video output terminal of a VCR, etc. You can also use it as a video output terminal.
- Video output terminal (pin jack)
Connect this terminal to the video input terminal of another Monitor.
You can also use it as a video input terminal.
- Audio input terminals (pin jack)
Connect these terminals to the audio output terminals of a VCR, etc.

Notes:

- Since the video output terminals on this Monitor are loop-through terminals, the devices connected to these video output terminals should be correctly terminated. Otherwise, picture becomes abnormally bright.
- When both the video and S-video terminals are connected, the S-video terminal will have priority.

9 COMPONENT input terminals (page 11)*

- Y, P_B/B-Y, P_R/R-Y input terminals (BNC)
Connect these terminals to the component signal output terminals of NTSC or high-vision equipment.
- Audio input terminals (pin jack)
Connect these terminals to the audio output terminals of another equipment.

10 RGB input terminals (page 11)

- PC input terminal (D-sub, 15-pin)
Connect this terminal to the video output terminal of a personal computer.
- Audio input terminals (pin jack)*
Connect these terminals to the audio output terminals of a personal computer.

Note:

* GD-V4200PCE and GD-V4200PCE-G do not have the following input terminals – VIDEO A, VIDEO B, COMPONENT and RGB AUDIO. To input video, S-video, component and audio signals, you need to install video interface kit (IF-C420P1W), which is separately purchased.

Preparations

Checking the Accessories

The following accessories are included with the Monitor. Check for them. If any item is missing, please contact the dealer where you purchased the Monitor.

- Remote control (RM-C575) x 1
- Remote control cable x 1
- Power cord (approx. 2.5 m) x 3 (Use the one matching the wall outlet.)
- Batteries (AA/R6P) x 2

Installing the Batteries

Put the batteries in the remote control as follows. If the remote control has become erratic in operation, change the batteries.

1 Remove the back cover.

While pushing the release lever on the cover, remove the cover in the direction of the arrow.

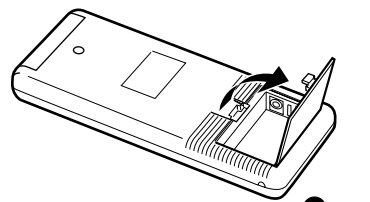

2 Place the batteries.

Put the two supplied batteries (AA/R6P), noting the ⊕ and ⊖ markings, as shown.

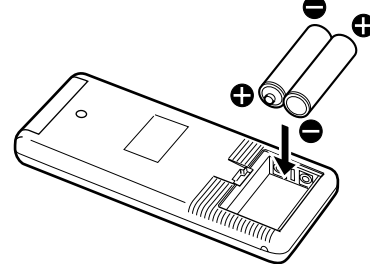

3 Replace the back cover as illustrated.

Make sure the release lever on the cover is locked in place correctly.

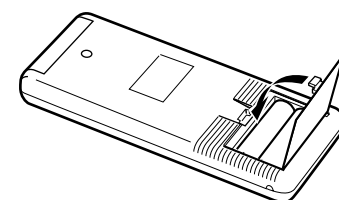

Precautions for using batteries

If batteries are used improperly, the liquid could leak out, causing a fire, injury, etc. or dirtying the vicinity.

Take notice of the following:

- Do not mix old and new batteries.
- Do not mix different types of battery as different types may have different characteristics.
- Place the batteries according to the ⊕ and ⊖ markings indicated on the battery compartment.
- When installing the batteries, insert the ⊖ end first to avoid a short circuit.
- Use only the specified batteries.
- When you are not using the remote control for a long time, remove the batteries.
- When the batteries have reached the end of their life, replace them with new ones immediately. Otherwise, the liquid may leak out, or malfunction may be caused by the leaked liquid. If the leaked liquid contacts your skin, wipe off the liquid with a soft cloth. If the affected skin is left as is, you may get a rough skin.
- Do not throw the batteries into fire or try recharging them.
- The service life of batteries is six months to one year for normal use. The supplied batteries are only for checking the operation and their life may be shorter. When the remote control operation becomes erratic, replace with new batteries.

Installation

Precautions

- When mounting the Monitor vertically, it is necessary to adjust the cooling fan speed to provide better heat dissipation. Do not forget to perform this adjustment. (See page 23.)
- When installing the Monitor, be sure to use a dedicated Stand Unit, Wall Mounting Unit, or Monitor Hanger Unit, depending on a particular case. Ask your dealer for installation.
- When installing the Monitor, refer also to the user manual for each option to use. Do not tilt the Monitor rightward, leftward, or backward.
- Route the power cord and connection cables along wall or floor corners to avoid walking on them.
- For good heat dissipation, try to leave the following distances of space (minimum) around the Monitor.
- The ambient temperature of the installation place should be within the range of 0°C to 40°C.
- When installing the Monitor in a place, such as near the ceiling, the remote control may not work correctly because of possible effects from the surroundings. If this happens, use the remote control as a wired remote control or move the Monitor where it is free from these effects.

When installing the Monitor on a stand

Front View

Side View

Unit: mm (inch)

Take measures against the Monitor from overturning:
 To protect against abnormal events such as earthquakes and to prevent unexpected accidents, take appropriate measures for preventing the Monitor from overturning; should it overturn, this could lead to personal injury.
 For detailed information, refer to the manual supplied for the stand.

When mounting the Monitor on the wall

Front View

Side View

Unit: mm (inch)

When hanging the Monitor from the ceiling

Side View

Unit: mm (inch)

Notes:

- Do not allow the same image (pattern) to be continuously displayed on the screen for a long time; otherwise, the area on the screen corresponding to the image may vary in brightness, leaving an afterimage on the screen. To reduce the afterimage, you can use the White Back function (see page 22).
- The Monitor is manufactured using very high-precision technology, allowing for more than 99.99% active pixels, however, be aware that only a slight number of pixels may be deficient or lit at all times.
- Do not install the Monitor in such a way that the Monitor and other AV equipment affect each other adversely. (For example, if a disturbed image or noise due to electromagnetic interference occurs, or if the infrared remote control malfunctions, change the installation place.)

Connections

Precautions

- Before making connections, turn off all the equipment.
- Plugs should be firmly inserted; poor connection could cause noise.
- To unplug a cord, be sure to grasp its plug and pull it out.
- Connect the power cord after having finished all other connections.
- Refer also to the user manual of each piece of equipment.

Available Signals

Video signals

The following signals can be input to this Monitor:

- VIDEO A and VIDEO B terminals accept — PAL, NTSC, and SECAM signals.
 - COMPONENT terminals accept — 480i, 576i, 480p, 720p, and 1080i signals.
- (For GD-V4200PCE and GD-V4200PCE-G, to input the above signals, you need to install the video interface kit (IF-C420P1W), which is separately purchased.)

Computer signals (Preset and user-defined video modes)

This Monitor has 13 preset video mode for the most popular industrial standard (marked with ● in the table below), and the signals of the following image resolutions can be input to the RGB input terminals.

For less common video modes, this Monitor can also display a picture, and memorize the video modes as user-defined video modes (up to five modes).

When a signal other than any of the preset modes is input, it will automatically be stored as a user-defined video mode, and when a sixth user-defined video signal is input, the first mode will be erased from memory.

| No. | Signal name | Screen resolution | | Horizontal Frequency (kHz) | Vertical Frequency (Hz) | Scan system | Preset setting |
|-----|--------------|-------------------|----------|----------------------------|-------------------------|---------------|----------------|
| | | Horizontal | Vertical | | | | |
| 1 | PC98 | 640 | 400 | 24.8 | 56.4 | Non-interlace | ● |
| 2 | VGA400-70 | 640 | 400 | 31.5 | 70.1 | Non-interlace | ● |
| 3 | VGA480-60 | 640 | 480 | 31.5 | 59.9 | Non-interlace | ● |
| 4 | VGA480-72 | 640 | 480 | 37.9 | 72.8 | Non-interlace | ● |
| 5 | VGA480-75 | 640 | 480 | 37.5 | 75.0 | Non-interlace | ● |
| 6 | MAC13" | 640 | 480 | 35.0 | 66.7 | Non-interlace | ● |
| 7 | SVGA-56 | 800 | 600 | 35.2 | 56.3 | Non-interlace | ● |
| 8 | SVGA-60 | 800 | 600 | 37.9 | 60.3 | Non-interlace | ● |
| 9 | SVGA-72 | 800 | 600 | 48.1 | 72.2 | Non-interlace | ● |
| 10 | XGA-60 | 1024 | 768 | 48.4 | 60.0 | Non-interlace | ● |
| 11 | XGA-70 | 1024 | 768 | 56.5 | 70.1 | Non-interlace | ● |
| 12 | RGB15K-60 | — | — | 15.7 | 59.9 | Interlace | ● |
| 13 | RGB15K-50 | — | — | 15.6 | 50.0 | Interlace | ● |
| — | User-defined | — | — | 15.0 – 16.0 | 50.0 – 75.0 | Interlace | |
| — | User-defined | — | — | 16.0 – 56.0 | 50.0 – 75.0 | Non-interlace | |

Notes:

- When you are viewing XGA, setting the refresh rate (vertical scan frequency) of your personal computer to 60 Hz will enhance the video image.
- When a signal other than listed above is input, a part of the screen may become void or an unnecessary picture may appear.
- Signals, though they are within the acceptable range of frequencies, may not be displayed normally, depending on the signal type.
- Depending on the connected equipment, the Monitor may not be compatible with composite sync (Cs) or G on sync signals.
- When a preset mode signal is input, the vertical frequency displayed on the screen will have an "*" shown at its right top position.
- When No. 7 to No. 11 signals are input, thin lines may happen to be hard to view on the screen, due to the internal digital processing.

Connection Examples

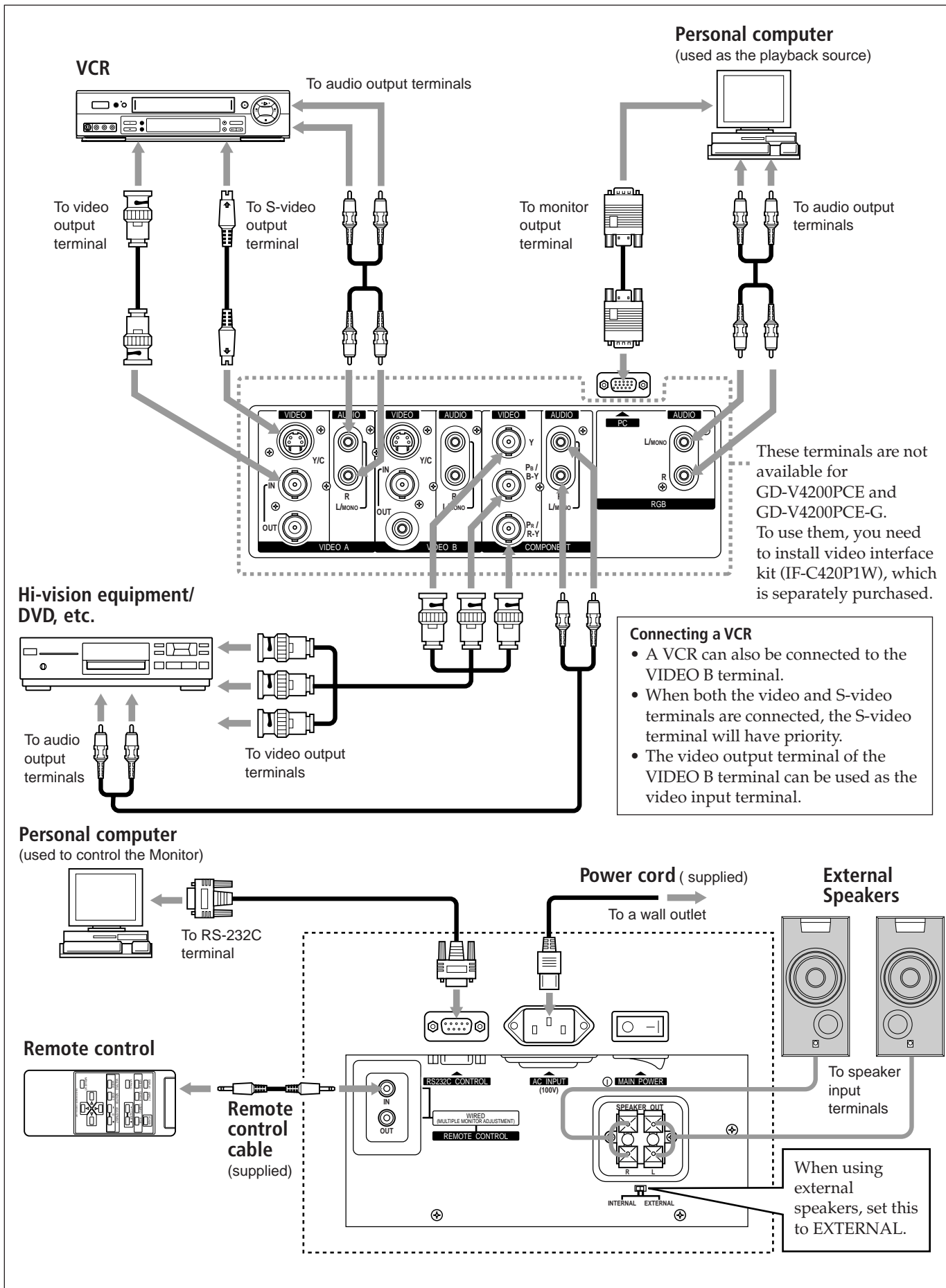

Basic Operations

Rear View

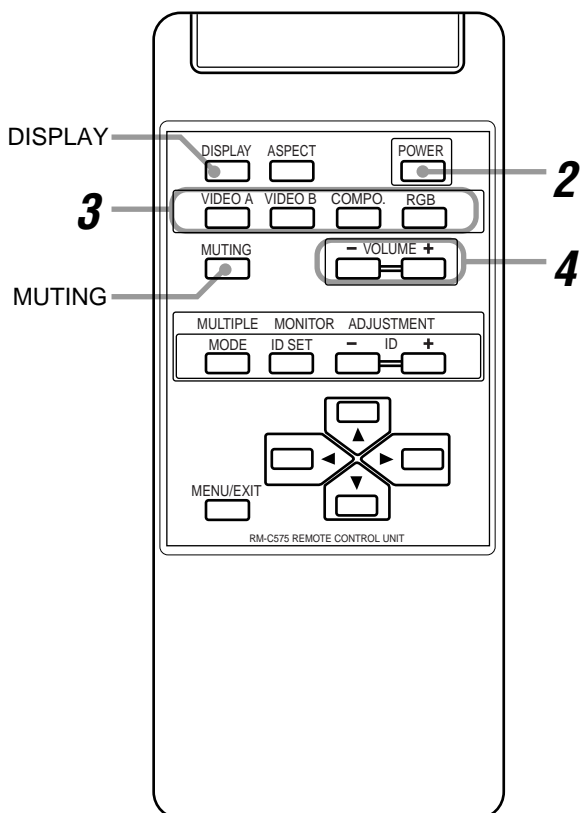
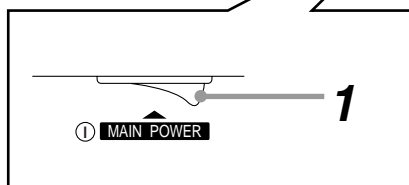
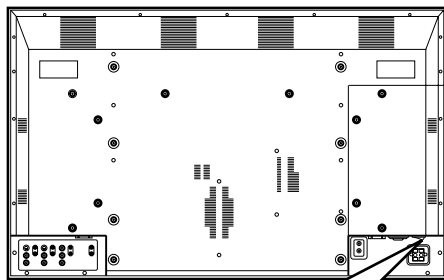

Daily Operations

1 Turn on the main power.

Set MAIN POWER on the back of the Monitor to ON. The POWER lamp on the upper left of the front panel glows red.

2 Turn on the power.

Press POWER on the remote control to turn the power on. The POWER lamp changes to glow green.

3 Select an input.

Select the desired input by pressing VIDEO A, VIDEO B, COMPO. or RGB.

- Only for GD-V4200PCE and GD-V4200PCE-G: Only RGB image is reproduced though you can select the other inputs.*

Ex. When selecting "VIDEO A" input

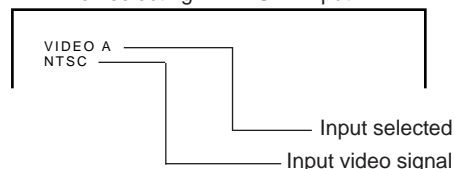

4 Adjust the volume.

- Only for GD-V4200PCE and GD-V4200PCE-G: No sound is reproduced.*

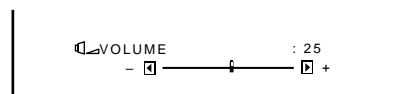

Notes:

- While no menu is displayed, you can adjust the volume by pressing ▲/▼ on the Monitor.
- You can also select the input by pressing INPUT on the Monitor. Each time you press the button, the input mode changes in sequence.
- When the INTERNAL/EXTERNAL selecting switch on the back of the Monitor is set to EXTERNAL, no sounds come out of the built-in speakers. When you want to hear audio sound from the built-in speakers, set the INTERNAL/EXTERNAL selecting switch to INTERNAL.

To turn off the volume immediately

Press **MUTING**.

"MUTING ON" is displayed, and the sound goes out. Pressing the button again resumes the previous volume level.

To make the screen indication appear

Press **DISPLAY**.

The types of input and signal are indicated on the screen. Pressing the button again will make the screen indication disappear.

You can also make the screen indication appear using menus (page 20).

* Only for GD-V4200PCE and GD-V4200PCE-G: You need to install the video interface kit (IF-C420P1W), which is separately purchased, to reproduce input images for VIDEO A, VIDEO B, COMPONENT and sounds.

Changing the Aspect Ratio

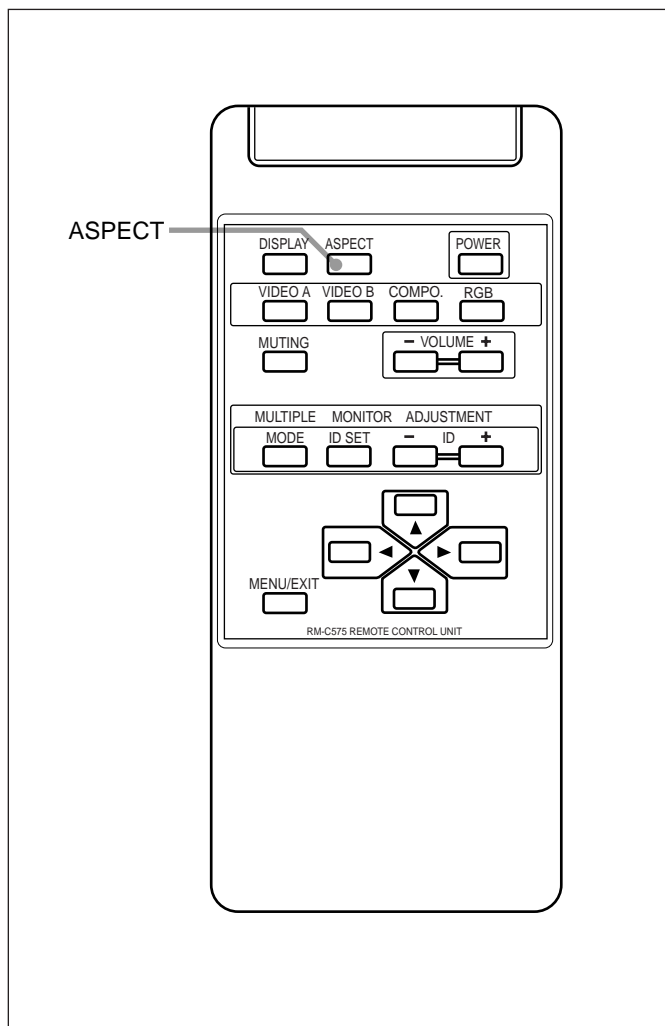

With this Monitor, you can select among three types of wide screens (FULL, ZOOM, and PANORAMIC) in addition to the REGULAR screen of conventional 4:3 aspect ratio.

Press ASPECT to select the screen size

Each time you press the button, the screen size changes as follows:

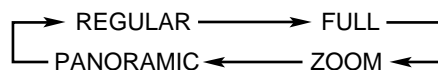

REGULAR: Displays at conventional 4:3 aspect ratio.

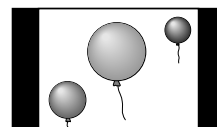

FULL: REGULAR size display is enlarged horizontally.

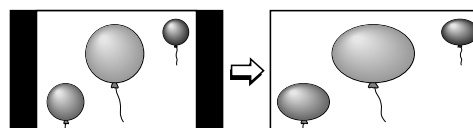

ZOOM: REGULAR size display is enlarged vertically and horizontally at the same ratio.

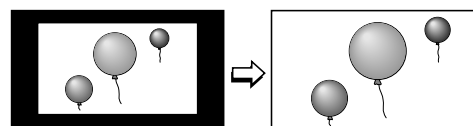

PANORAMIC: REGULAR size display is enlarged horizontally to the extent that the picture does not look abnormally.

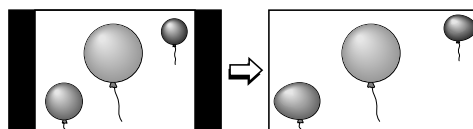

Precautions for using the screen mode switching function

- This Monitor features a screen mode switching (aspect ratio change) function. If you select a mode different in aspect ratio from software such as TV programs, the picture may look different from original picture. Be aware of this point when you are selecting a screen mode.
- If you select a wide screen mode while viewing conventional video programs of the aspect ratio 4:3, some portions (edges) of the original picture will be cut off, or deformed. To enjoy the original picture as it is, select "REGULAR" while viewing such programs.
- If you place the Monitor in a tea room, hotel, etc. for business purposes or public viewing and modify the picture by using the screen mode switching (aspect ratio change) function, this could violate the copyright protected by the copyright law, which requires your special attention.
- If you make the screen very bright and watch programs selecting "REGULAR" for a long period of time, the Monitor screen may happen to be burned in. If this occurs, watching programs using a wide screen mode for a while will reduce the burn-in gradually.

Notes:

- When one of the following signals is being input, the aspect ratio is fixed and cannot be changed.
Aspect ratio is fixed to FULL: When 1080i or 720p signal comes in (through the COMPONENT input terminals)
 When 480p signal (through the COMPONENT input terminals) and any signal comes in (through the RGB input terminals), you can select only REGULAR and FULL.
- The aspect ratio can also be changed on the Function Selection Menu (page 18).

Video Adjustments

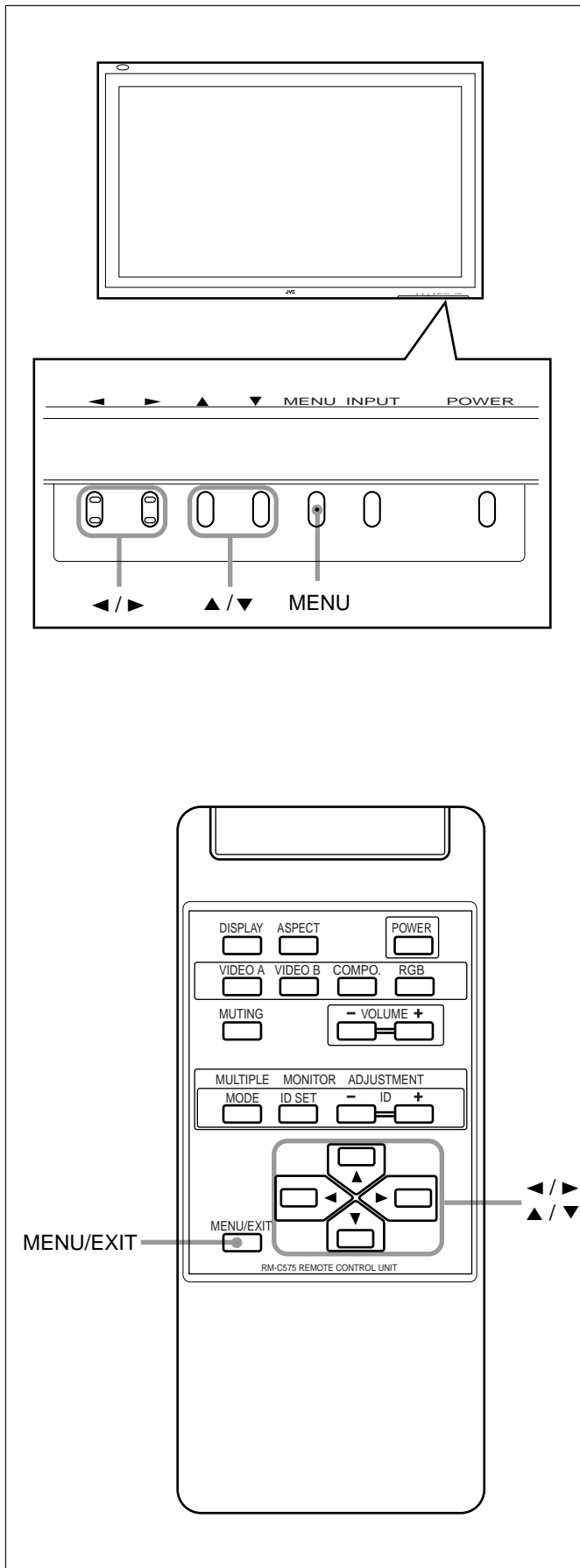

For video adjustments, use menus.

You can use the buttons either on the remote control or on Monitor for menu operations.

- Refer also to “Menu Classifications” on pages 26 and 27.

Adjusting the Screen Size and Position (For RGB input only)

While RGB input is selected, the screen size and position can be adjusted.

Adjusted settings can be stored for each signal type; therefore, when the same signal comes in, the stored settings are recalled.

- When adjusting the size, the size cannot be adjusted proportionally, but can be enlarged rightward (or downward) only and reduced leftward (or upward) only. Therefore, it is necessary to adjust both the size and position alternately to adjust to the appropriate size.

1 Press MENU/EXIT (or MENU on the Monitor) to display the Main Menu.

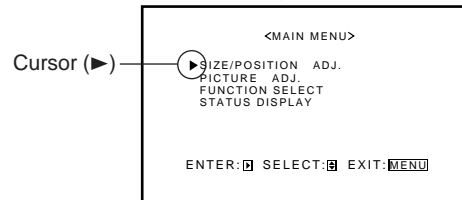

2 Press ▲/▼ to move the cursor (▶) to “SIZE/POSITION ADJ.”

3 Press ▶ to display the Size/Position Adjustment Menu.

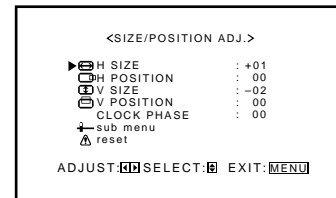

4 Press ▲/▼ to move the cursor (▶) to the item you want to adjust.

| Item | Adjustment range |
|---------------------|--|
| H (horizontal) SIZE | -80 to +80 |
| H POSITION | -80 to +80 |
| V (vertical) SIZE | -80 to +80 |
| V POSITION | -80 to +80 |
| CLOCK PHASE* | -20 to +20 |
| sub menu | See “To make an adjustment while viewing the adjustment bar” on the next page. |
| reset | See “To reset the adjustments” on the next page. |

* CLOCK PHASE can be used to reduce flickering and blurring on the screen after adjusting the screen size.

5 Press ◀/▶ to adjust the selected item.

6 Press MENU/EXIT (or MENU on the Monitor) twice to exit from the menu operations.

To make an adjustment while viewing the adjustment bar

After step 3 on page 14, proceed as follows:

- 1 Press ▲/▼ to move the cursor (▶) to "sub menu."
 - 2 Press ▶ to display the Sub Menu.
- The Sub Menu for H SIZE appears on the screen.

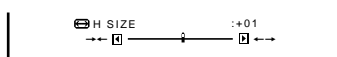

- 3 Press ▲/▼ to select the Sub Menu you want to adjust. Each time you press the button, the Sub Menu changes as follows:

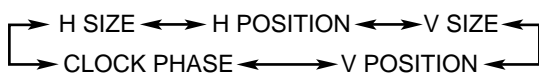

- 4 Press ◀/▶ to adjust the selected item.
- 5 Repeat steps 3 and 4 to adjust the other items.
- 6 Press MENU/EXIT (or MENU on the Monitor) three times to exit from the menu operations.

To reset the adjustments

After step 3 on page 14, proceed as follows:

- 1 Press ▲/▼ to move the cursor (▶) to "reset."
 - 2 Press ▶.
- The confirmation screen appears.

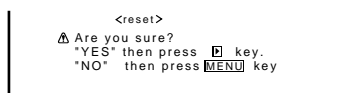

- 3 Press ▶ again to reset the adjustments.
- To cancel the reset, press MENU/EXIT (or MENU on the Monitor).

Note:

- Adjustment values for both horizontal and vertical sizes of the screen are so related that if one is adjusted up to near the maximum value, the attainable value of the other will be decreased.

Adjusting the Picture Quality

Picture quality can be set for each input mode.

1 Press MENU/EXIT (or MENU on the Monitor) to display the Main Menu.

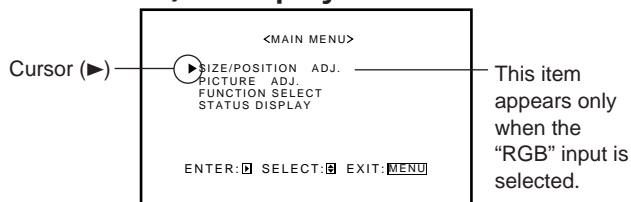

2 Press ▲/▼ to move the cursor (▶) to "PICTURE ADJ."

3 Press ▶ to display the Picture Adjustment Menu.

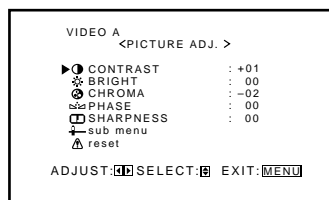

4 Press ▲/▼ to move the cursor (▶) to the item you want to adjust.

| Item | Adjustment range |
|---------------------|--|
| CONTRAST | -20 to +20 |
| BRIGHT (brightness) | -20 to +20 |
| CHROMA* | -20 to +20 |
| PHASE** | -20 to +20 |
| SHARPNESS | -20 to +20 |
| sub menu | See "To make an adjustment while viewing the adjustment bar" on the next page. |
| reset | See "To reset the adjustments" on the next page. |

* Adjustment is not possible when RGB input is selected.
 ** Adjustment is only possible when viewing NTSC signal through the VIDEO A or B terminal.

5 Press ◀/▶ to make adjustments.

6 Press MENU/EXIT (or MENU on the Monitor) twice to exit from the menu operations.

Video Adjustments (Continued)

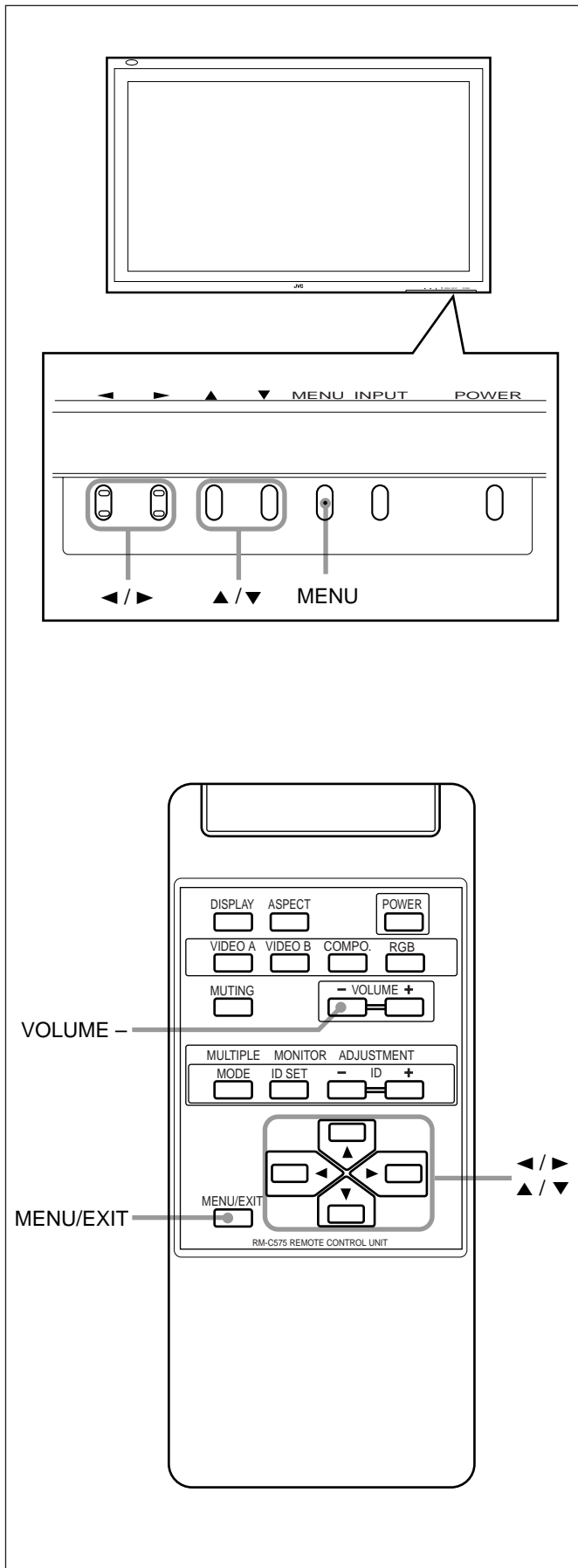

To make an adjustment while viewing the adjustment bar

After step 3 on page 15, proceed as follows:

- 1 Press ▲/▼ to move the cursor (▶) to "sub menu."
- 2 Press ▶ to display the Sub Menu.
The Sub Menu for CONTRAST appears on the screen.

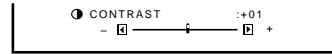

- 3 Press ▲/▼ to select the Sub Menu you want to adjust.
Each time you press the button, the Sub Menu changes as follows:

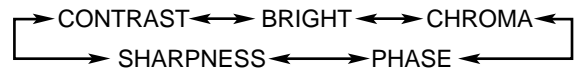

- 4 Press ◀/▶ to adjust the selected item.
- 5 Repeat steps 3 and 4 to adjust the other items.
- 6 Press MENU/EXIT (or MENU on the Monitor) three times to exit from the menu operations.

To reset the adjustments

After step 3 on page 15, proceed as follows:

- 1 Press ▲/▼ to move the cursor (▶) to "reset."
- 2 Press ▶.
The confirmation screen appears.

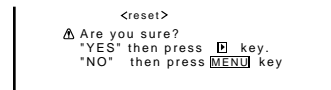

- 3 Press ▶ again to reset the adjustments.
To cancel the reset, press MENU/EXIT (or MENU on the Monitor).

Adjusting the Color Temperature

The adjusted setting applies to all inputs.

- 1 Press MENU/EXIT (or MENU on the Monitor) to display the Main Menu.

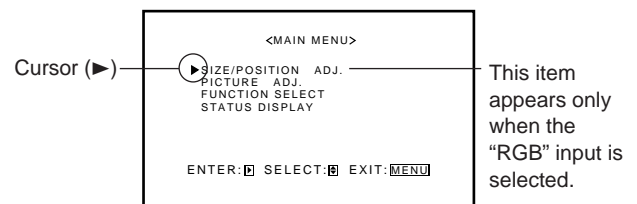

- 2 Press ▲/▼ to move the cursor (▶) to "FUNCTION SELECT."

- 3 Press ▶ to display the Function Selection Menu.

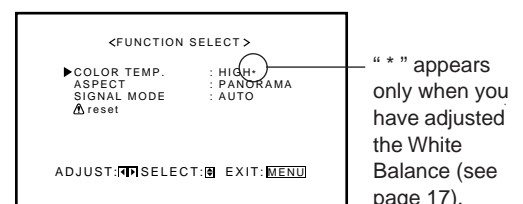

4 Press ▲/▼ to move the cursor (▶) to "COLOR TEMP."

5 Press ◀/▶ to make an adjustment.
Each time you press the button, the color temperature alternate between "HIGH" and "LOW."

- HIGH: To make the screen become bluish.
- LOW: To make the screen become reddish.

6 Press MENU/EXIT (or MENU on the Monitor) twice to exit from the menu operations.

To reset the setting

You can only reset the color temperature, aspect ratio (see page 18), and video signal type (see page 19) at the same time. See "Resetting the Function Selection Menu Settings" on page 19.

Note:

- To make a fine adjustment, adjust "WHITE BALANCE" (see below).

Adjusting the White Balance

G GAIN, B GAIN and R GAIN can be finely adjusted separately for "HIGH" and "LOW" settings of the color temperature.

When using plural numbers of the Monitors, this can be useful to have the same color on each screen.

1 On the remote control:
Press MENU/EXIT while holding VOLUME – to display the Setup Menu.

On the Monitor:
Press MENU while holding ◀ to display the Setup Menu.

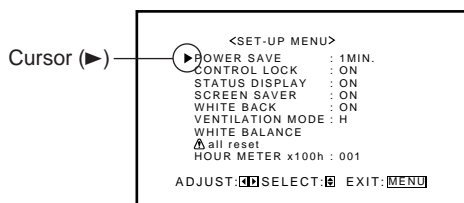

2 Press ▲/▼ to move the cursor (▶) to "WHITE BALANCE."

3 Press ▶ to display the White Balance Adjustment Menu.

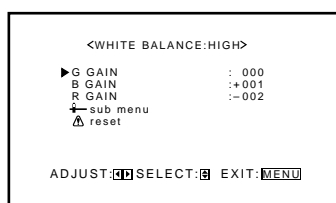

4 Press ▲/▼ to move the cursor (▶) to the item you want to adjust.

5 Press ◀/▶ to adjust the selected item.

6 Repeat steps 4 and 5 to adjust the other items.

7 Press MENU/EXIT (or MENU on the Monitor) twice to exit from the menu operations.

Notes:

- Adjustable range will vary among the Monitors.
- "MAX" may appear soon after you begin adjustment. This is normal but not a malfunction.

To make an adjustment while viewing the adjustment bars

After step 3 of the above procedure, proceed as follows:

1 Press ▲/▼ to move the cursor (▶) to "sub menu."

2 Press ▶ to display the Sub Menu.
The Sub Menu for G GAIN appears on the screen.

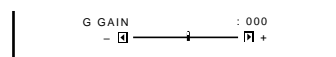

3 Press ▲/▼ to select the Sub Menu you want to adjust.

Each time you press the button, the Sub Menu changes as follows:



4 Press ◀/▶ to adjust the selected item.

5 Repeat steps 3 and 4 to adjust the other items.

6 Press MENU/EXIT (or MENU on the Monitor) three times to exit from the menu operations.

To reset the adjustments

After step 3 of the above procedure, proceed as follows:

1 Press ▲/▼ to move the cursor (▶) to "reset."

2 Press ▶.
The confirmation screen appears.

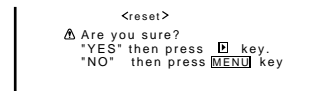

3 Press ▶ again to reset the adjustments.

To cancel the reset, press MENU/EXIT (or MENU on the Monitor).

Video Adjustments (Continued)

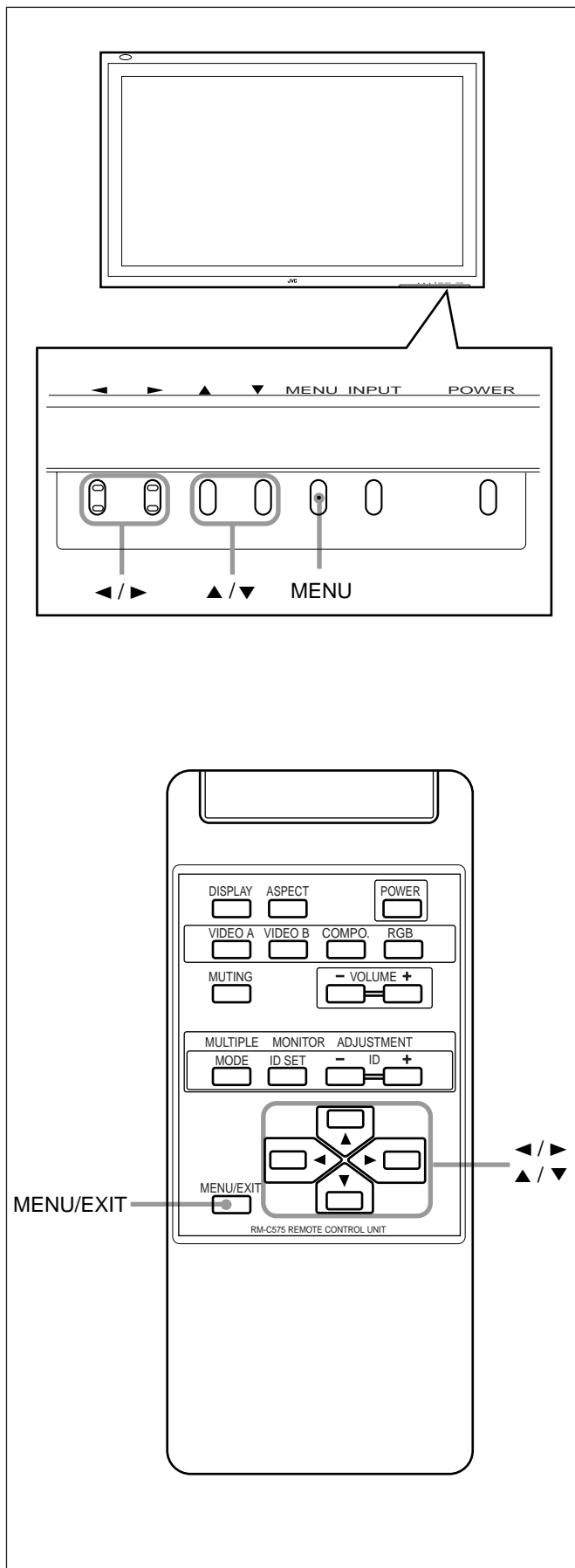

Changing the Aspect Ratio

The setting adjusted applies to all inputs.

- You can change the aspect ratio by pressing ASPECT. (See page 13.)

1 Press MENU/EXIT (or MENU on the Monitor) to display the Main Menu.

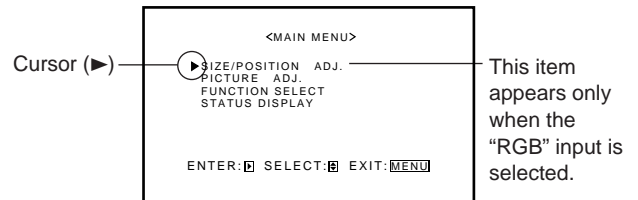

2 Press ▲/▼ to move the cursor (▶) to "FUNCTION SELECT."

3 Press ▶ to display the Function Selection Menu.

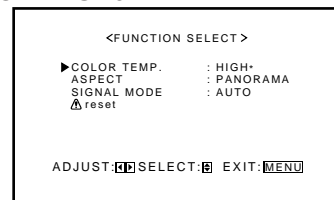

4 Press ▲/▼ to move the cursor (▶) to "ASPECT."

5 Press ◀/▶ to select an aspect ratio you want.

Each time you press the button, the aspect ration changes as follows:

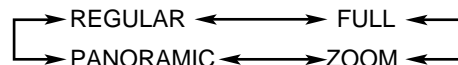

* For detailed information on these aspect ratios, see page 13.

6 Press MENU/EXIT (or MENU on the Monitor) three times to exit from the menu operations.

To reset the setting

You can only reset the color temperature (see page 16), aspect ratio, and video signal type (see page 19) at the same time. See "Resetting the Function Selection Menu Settings" on the next page.

Note:

- When one of the following signals is being input, the aspect ratio is fixed and cannot be changed.

Aspect ratio is fixed to FULL: When 1080i or 720p signal comes in (through the COMPONENT input terminals)

When 480p signal (through the COMPONENT input terminals) and any signal comes in (through the RGB input terminals), you can select only REGULAR and FULL.

Setting the Receivable Signal Types

You can set the receivable signal types. Normally, select "AUTO."

A common setting will apply to both VIDEO A and B terminals, and a different setting will apply to the COMPONENT terminal.

1 Press MENU/EXIT (or MENU on the Monitor) to display the Main Menu.

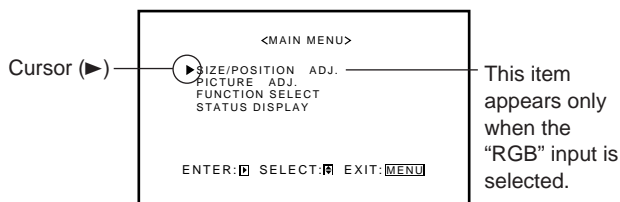

2 Press ▲/▼ to move the cursor (▶) to "FUNCTION SELECT."

3 Press ▶ to display the Function Selection Menu.

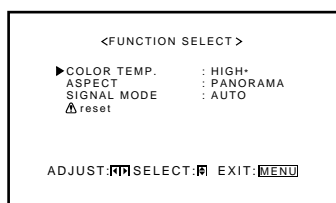

4 Press ▲/▼ to move the cursor (▶) to "SIGNAL MODE."

5 Press ◀/▶ to select the receivable video signal type.

Each time you press the button, the receivable video signal type changes as follows:

- When VIDEO A or VIDEO B input is selected:

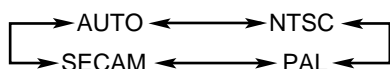

- When COMPONENT input is selected:

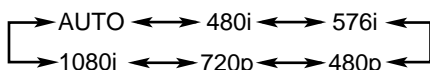

6 Press MENU/EXIT (or MENU on the Monitor) twice to exit the menu operations.

To reset the setting

You can only reset the color temperature (see page 16), aspect ratio (see page 18), and video signal type at the same time. See "Resetting the Function Selection Menu Settings" described in the right column.

Resetting the Function Selection Menu Settings

You can reset all the following Function Selection Menu settings at a time.

- Colour Temperature (see page 16)
- Aspect Ratio (see page 18)
- Receivable Signal Types: SIGNAL MODE (see the left column)

1 Press MENU/EXIT (or MENU on the Monitor) to display the Main Menu.

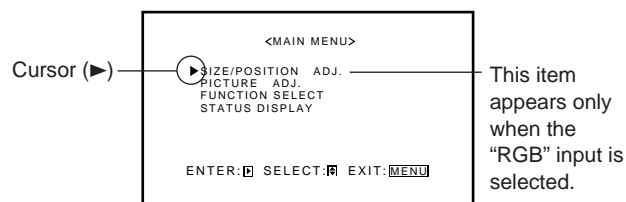

2 Press ▲/▼ to move the cursor (▶) to "FUNCTION SELECT."

3 Press ▶ to display the Function Selection Menu.

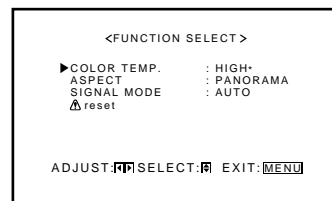

4 Press ▲/▼ to move the cursor (▶) to "reset."

5 Press ▶.

The confirmation screen appears.

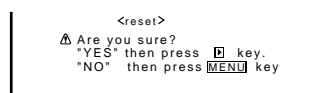

6 Press ▶ again to reset the adjustments.

To cancel the reset, press MENU/EXIT (or MENU on the Monitor).

Other Convenient Functions

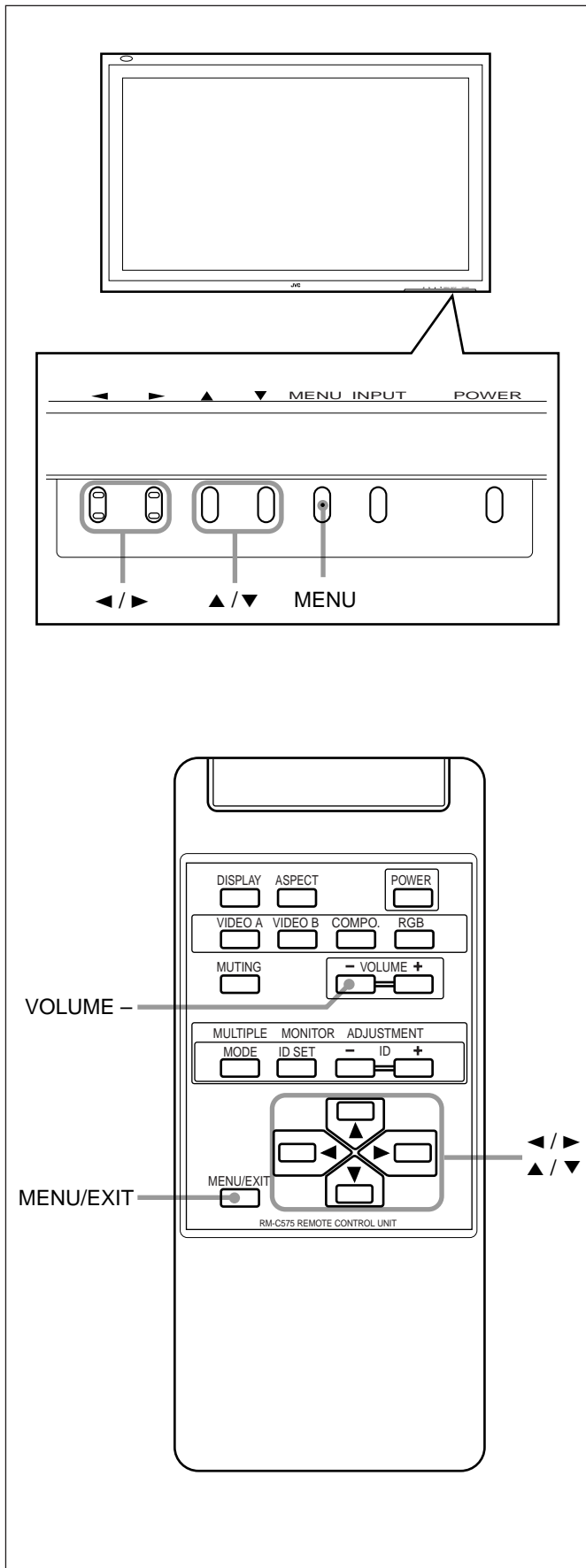

To set the other convenient functions, use menus. You can use the buttons either on the remote control or on Monitor for menu operations.

- Refer also to “Menu Classifications” on pages 26 and 27.

Showing On-screen Display

The input mode and signal type will be indicated on the screen.

- The following procedure can be done by using the buttons on the Monitor. You can also show these information by pressing DISPLAY on the remote control. (See page 12.)

- 1 Press MENU (or MENU/EXIT on the remote control) to display the Main Menu.**

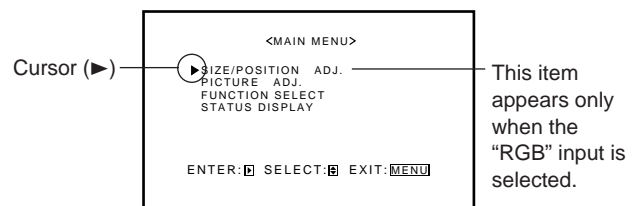

- 2 Press ▲/▼ to move the cursor (▶) to “STATUS DISPLAY.”**

- 3 Press ▶ to display the current input terminal and received signal type.**

Ex. When selecting “VIDEO A” input

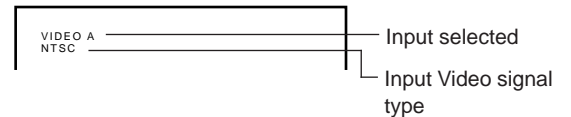

Ex. When selecting “COMPONENT” input



Ex. When selecting “RGB” input

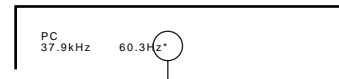

When the signal being input is a preset video mode, an “*” will be shown after the frequency.

Note:

- If you want to make these information appear automatically when you change the input mode, see “Showing the On-screen When Changing the Input Mode” on page 22.

Confirming the Use Time

You can confirm the hours of use on the Setup Menu. This may be necessary when you ask for any service.

- On the remote control:**
Press MENU/EXIT while holding VOLUME – to display the Setup Menu.

On the Monitor:
Press MENU while holding ◀ to display the Setup Menu.

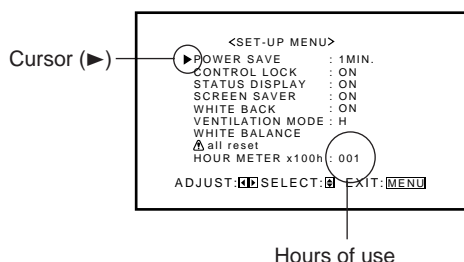

- Confirm the hour of use.**
 - The displayed value for the hours of use is divided by 100. To calculate the actual hours of use, multiply the displayed value by 100.
- Press MENU/EXIT (or MENU on the Monitor) twice to exit from the menu operations.**

Notes:

- The value for the hours of use is added by one hour unit. If you use the monitor within one hour. It will not be added to the hours of use.
- The period when the monitor is on standby (the power lamp glows red) will not be added to the hours of use.

Setting the Power Saving Function

This function allows you to turn off (into standby mode) automatically when no signal comes in for a certain period of time.

- On the remote control:**
Press MENU/EXIT while holding VOLUME – to display the Setup Menu.

On the Monitor:
Press MENU while holding ◀ to display the Setup Menu.

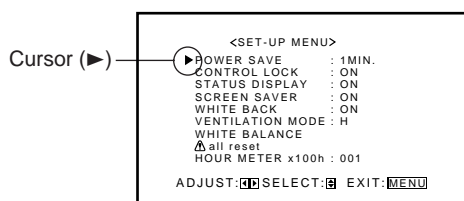

- Press ▲/▼ to move the cursor (▶) to "POWER SAVE."**

- Press ◀/▶ to select the desired amount of time.**

Select the number of minutes before the Monitor goes into standby mode after the signal has ceased to be supplied.

Each time you press the button, the amount of time changes as follows:

OFF ↔ 1 MIN. ↔ 2 MIN. ↔ 3 MIN. ↔ 4 MIN. ↔ 5 MIN.

To cancel the Power Saving function, select "OFF."

- Press MENU/EXIT (or MENU on the Monitor) twice to exit from the menu operations.**

Prohibiting the Monitor's Button Operations

This function allows you to prohibit the button operations on the Monitor to prevent malfunction or avoid tampering.

- On the remote control:**
Press MENU/EXIT while holding VOLUME – to display the Setup Menu.

On the Monitor:
Press MENU while holding ◀ to display the Setup Menu.

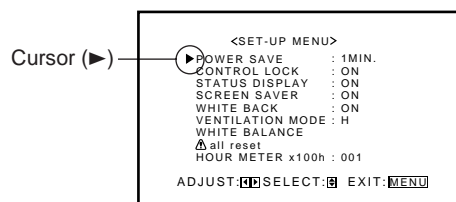

- Press ▲/▼ to move the cursor (▶) to "CONTROL LOCK."**
- Press ◀/▶ to select the desired setting.**
Each time you press the button, the Control Lock function alternates between "ON" and "OFF."
To cancel the Control Lock function, select "OFF."
- Press MENU/EXIT (or MENU on the Monitor) twice to exit from the menu operations.**

Note:

- Even when the Control Lock function is in use, the following operations are possible:
 - Operation to cancel the Control Lock function
 - All operations from the remote control

Other Convenient Functions (Continued)

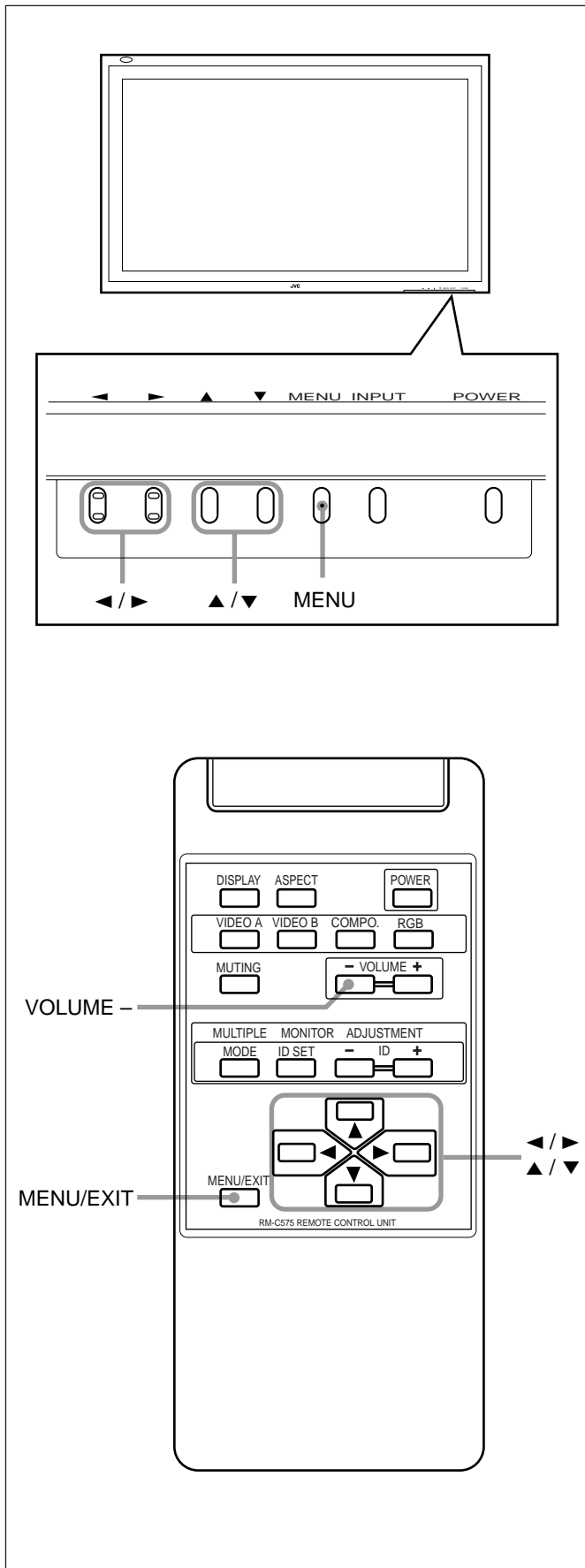

Reducing the Afterimage Effect

After the power is turned off, a whitish image may be left on the screen. In that case, leave the monitor in a white back state for a while, and the image will disappear.

- On the remote control:**
Press MENU/EXIT while holding VOLUME - to display the Setup Menu.

On the Monitor:
Press MENU while holding ◀ to display the Setup Menu.

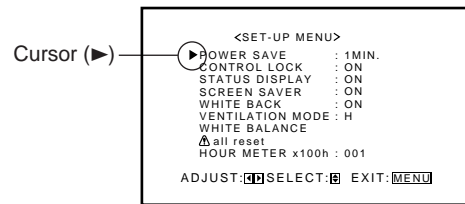

- Press ▲/▼ to move the cursor (▶) to "WHITE BACK."
- Press ◀/▶ to select the desired setting. The Setup Menu disappears, and the white screen appears.

To cancel the White Back function
Repeat steps 1 and 2, then select "OFF" by pressing ◀/▶.

Showing the On-screen When Changing the Input Mode

With this function, you can see the selected input mode and signal type when changing the input mode.

- On the remote control:**
Press MENU/EXIT while holding VOLUME - to display the Setup Menu.

On the Monitor:
Press MENU while holding ◀ to display the Setup Menu.

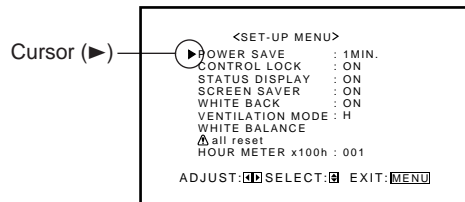

- Press ▲/▼ to move the cursor (▶) to "STATUS DISPLAY."

3 Press ◀/▶ to select the desired setting.

Each time you press the button, the Status Display function alternates between "ON" and "OFF."

To cancel the Status Display function, select "OFF."

4 Press MENU/EXIT (or MENU on the Monitor) twice to exit from the menu operations.

Using the Screen Saver Function

With this function, you can avoid the screen from being burned in.

1 On the remote control:
Press MENU/EXIT while holding VOLUME – to display the Setup Menu.

On the Monitor:
Press MENU while holding ◀ to display the Setup Menu.

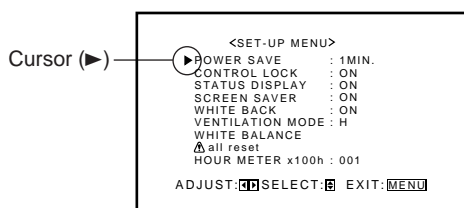

2 Press ▲/▼ to move the cursor (▶) to "SCREEN SAVER."

3 Press ◀/▶ to select the desired setting.

Each time you press the button, the Screen Saver function alternates between "ON" and "OFF."

To cancel the Screen Saver function, select "OFF."

4 Press MENU/EXIT (or MENU on the Monitor) twice to exit from the menu operations.

Mounting the Monitor Vertically

When mounting the Monitor vertically, the temperature inside the Monitor rises more than it is mounted horizontally. To provide better heat dissipation, it is necessary to perform the adjustment to switch fan speeds.

1 On the remote control:
Press MENU/EXIT while holding VOLUME – to display the Setup Menu.

On the Monitor:
Press MENU while holding ◀ to display the Setup Menu.

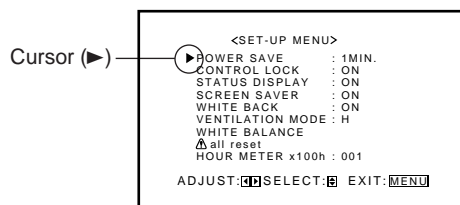

2 Press ▲/▼ to move the cursor (▶) to "VENTILATION MODE."

3 Press ◀/▶ to select "V."

Each time you press the button, the Ventilation Mode alternates between "H (horizontal mounting)" and "V (vertical mounting)."

4 Press MENU/EXIT (or MENU on the Monitor) twice to exit from the menu operations.

Resetting All the Setup Menu Settings

You can reset all the following Setup Menu settings at a time.

- Power Saving function (see page 21)
- Control Lock function (see page 21)
- Status Display function (see page 22)
- Screen Saver function (see the left column)
- White Back function (see page 22)
- White Balance adjustments (see page 17)

1 On the remote control:
Press MENU/EXIT while holding VOLUME – to display the Setup Menu.

On the Monitor:
Press MENU while holding ◀ to display the Setup Menu.

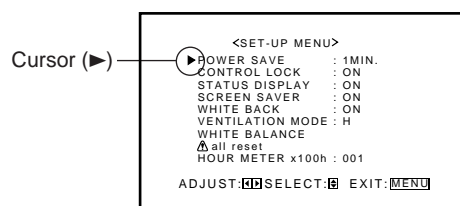

2 Press ▲/▼ to move the cursor (▶) to "all reset."

3 Press ▶.

The confirmation screen appears.

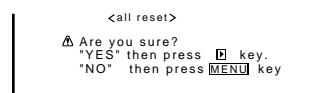

4 Press ▶ again to reset all the settings.

To cancel the reset, press MENU/EXIT (or MENU on the Monitor).

Serial Connections and Operations

When the Monitors are serially connected, you can control all of them at the same time (simultaneous operation) or control them one by one separately (individual operation).

For individual operation, you have to assign an ID number to each of the Monitors.

For the purpose of explanation, we will call Monitor 1 as a Master and Monitor 2 and subsequent Monitors as Slaves.

Connecting the Remote Control Cables

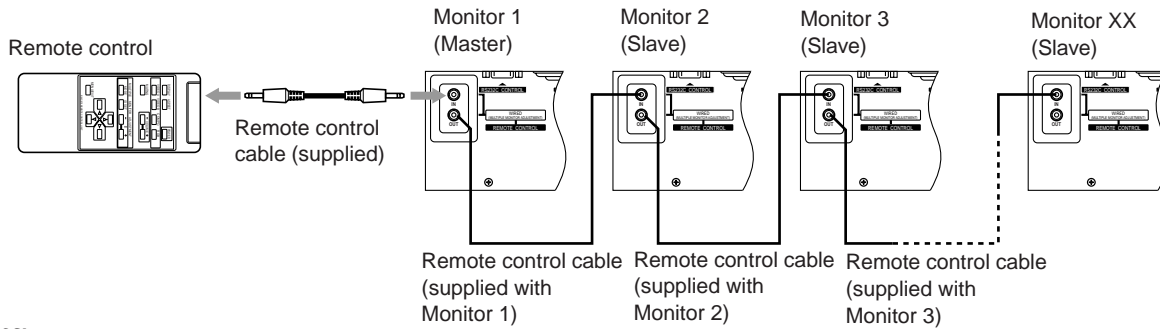

Notes:

- Do not connect the last monitor to Monitor 1.
- When operating with a wired remote control, connect it to the REMOTE CONTROL input terminal of Monitor 1.
- When Monitors are serially connected, Monitor 2 and subsequent Monitors cannot be directly controlled with a wireless remote control.
- Even after the Monitors are serially connected, each of them can be operated using the buttons on the Monitor. However, you cannot perform simultaneous or individual operation even with the buttons on Master Monitor.

Assigning ID Numbers

- When performing simultaneous or individual operation, use the remote control.

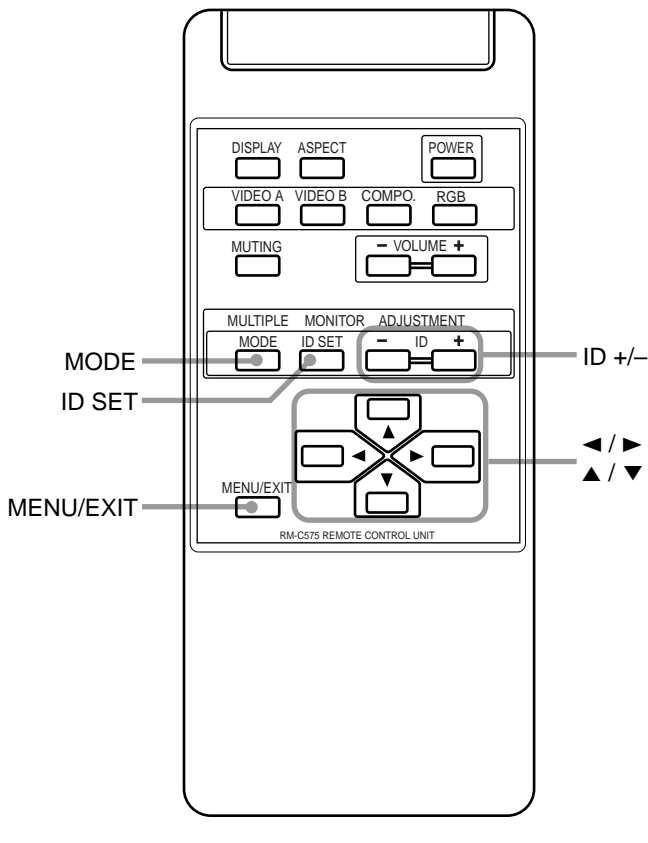

The following procedure should be performed slowly and securely.

1 Turn on all the connected Monitors.

2 Press MODE.

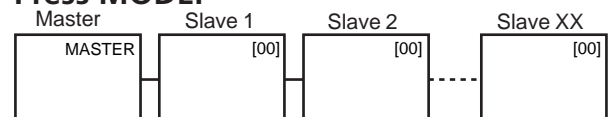

On Master Monitor screen, "MASTER" is displayed, and "[00]" is displayed on all of Slave Monitor screens.

3 Press ID SET.

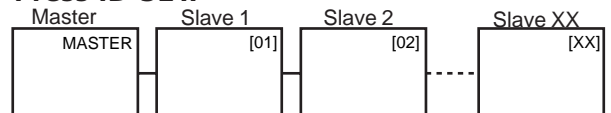

On the Slave Monitor screens, "[01]", "[02]", "[03]", — and so on will be displayed in the order of connection.

Notes:

- When a maximum number of 20 Monitors are connected, it will take approx. 10 seconds for ID numbers to be displayed on all the screens.
- If "[00]" is displayed on all the Monitor screens or if some of the Monitors have no indication in step 1, press MODE to turn off the indications on all Monitor screens, and then press MODE again.

Operating the Monitors Simultaneously

- Check that no ID number is shown on the screens. If any ID numbers are shown, press MODE to erase them.
- The following procedure should be performed slowly and securely.

Example: When adjusting "CONTRAST":

1 Press MENU/EXIT to display the Main Menu.

The Main Menus appear on all the connected Monitors' screens.

2 Press ▲/▼ to move the cursor (▶) to "PICTURE ADJ."

3 Press ▶ to display the Picture Adjustment Menu.

The Picture Adjustment Menus appear on all the connected Monitors' screens.

4 Press ▲/▼ to move the cursor (▶) to "CONTRAST."

5 Press ◀/▶ to make an adjustment.

At this time, if the Monitors have different "CONTRAST" settings, the adjustment is made, based on the different settings.

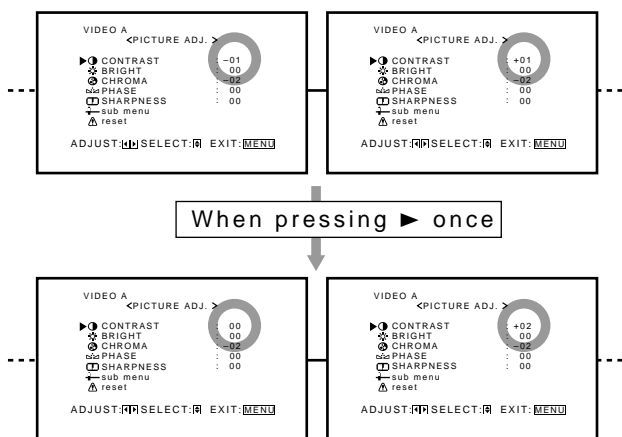

6 Press MENU/EXIT twice to exit from the menu operations.

Operating the Monitors Individually

The following procedure should be performed slowly and securely.

1 Press MODE to display the ID numbers on all the connected Monitors' screens.

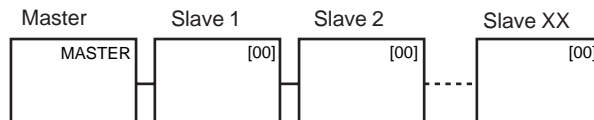

2 Press ID +/- to select the Monitor you want to operate.

Example: To select "[02]":

Press ID + twice.

Slave 2's ID number "[02]" is highlighted.

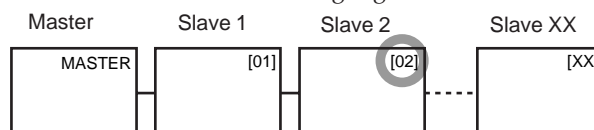

3 Perform any desired operations, such as adjusting menu items.

Notes:

- If "[00]" is displayed on all the Monitor screens or if some of the Monitor screens have no indication in step 1, press MODE to turn off the indications on all screens, and then press MODE again.
- If the ID number of the Monitor selected in step 2 is not highlighted or if the ID numbers of more than one Monitor are highlighted, press MODE to clear the ID numbers, and then start the procedure again from the beginning.

Menu Classifications

Main Menu

Main Menu

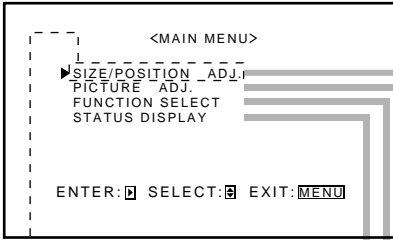

Appears only when "RGB" input is selected.

Size/Position Adjustment Menu

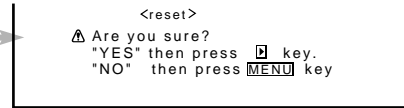
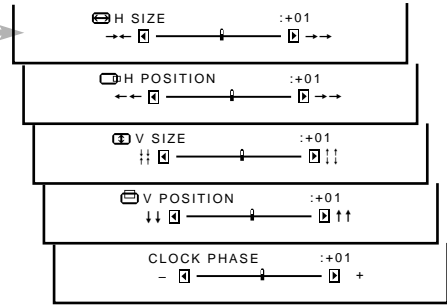
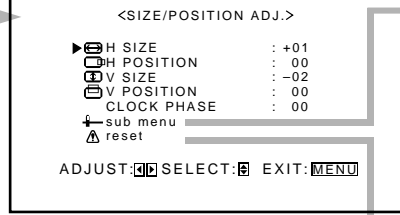

Picture Adjustment Menu

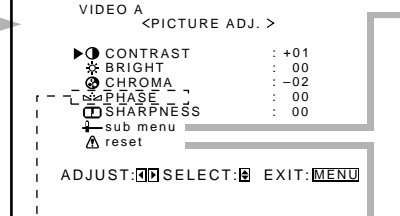

Adjustable only when NTSC signals come in.

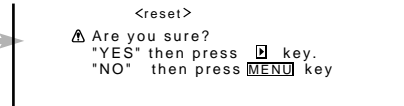
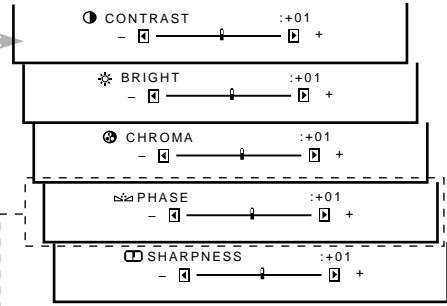

Function Selection Menu

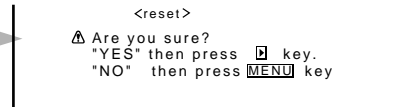
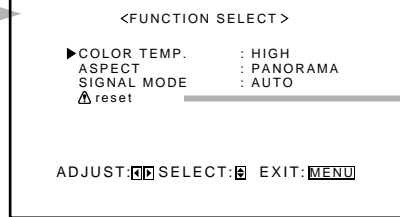

Status Display

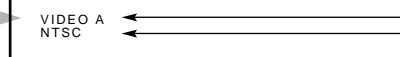

Input currently selected
Input video signal

Ex. When "VIDEO A" input is selected

SIZE/POSITION ADJ.* : See page 14.

| | |
|--------------|---|
| H.SIZE* | Adjusts the horizontal screen size. |
| H. POSITION* | Adjusts the horizontal screen position. |
| V. SIZE* | Adjusts the vertical screen size. |
| V.POSITION* | Adjusts the vertical screen position. |
| CLOCK PHASE* | Adjusts to eliminate stripes or flickering. Normally, no adjustment is needed. |
| sub menu | Displays the fine adjustment bar. |
| reset | Resets Size/position Adjustment Menu settings to defaults. |

PICTURE ADJ. (Picture adjustment): See page 15.

| | |
|-----------|--|
| CONTRAST | Adjusts the contrast of the picture. |
| BRIGHT | Adjusts the brightness of the picture. |
| CHROMA** | Adjusts the color density of the picture. |
| PHASE*** | Adjusts the color phase. |
| SHARPNESS | Adjusts the outlines of the picture. |
| sub menu | Displays the fine adjustment bar. |
| reset | Resets the Picture Adjustment Menu settings to defaults. |

FUNCTION SELECT: See pages 16 to 19.

| | |
|-------------|--|
| COLOR TEMP. | Adjusts the color temperature. Use when the picture is reddish or bluish. |
| ASPECT | Selects the horizontal to vertical ratio of the screen. |
| SIGNAL MODE | <ul style="list-style-type: none"> • Selects a color system (NTSC, PAL, SECAM) when VIDEO A or VIDEO B input is selected. • Selects a scan system (480i, 576i, 480p, 720p, 1080i) when COMPONENT input is selected. Normally, set to "AUTO." |
| reset | Resets the Function Selection Menu settings to defaults. |

* Adjustment is only possible when RGB input is selected.

** Adjustment is not possible when RGB input is selected.

*** Adjustment is only possible when viewing NTSC signal through the VIDEO A or B terminal.

Setup Menu

Setup Menu

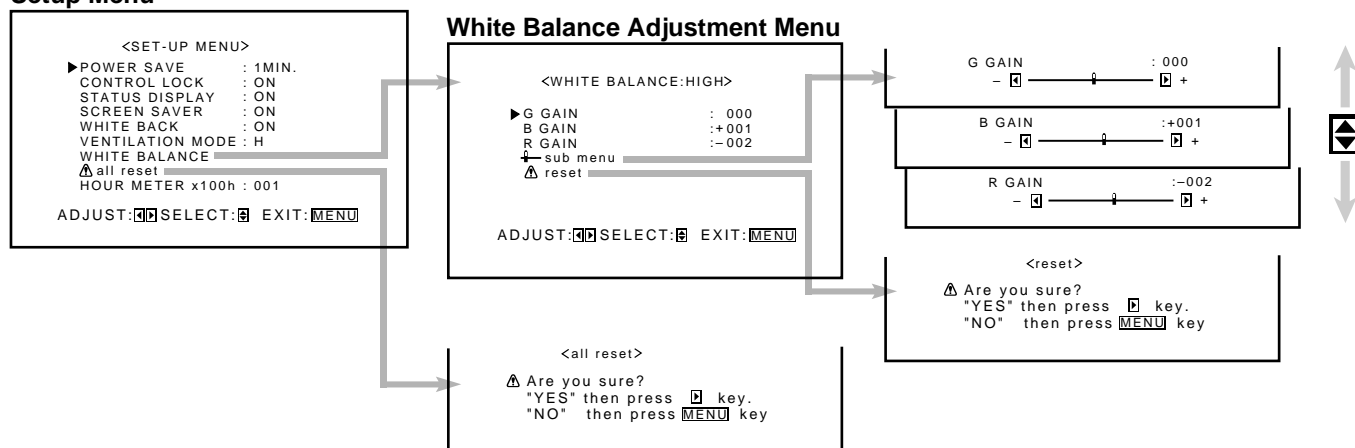

| | |
|------------------|---|
| POWER SAVE | Sets the length of time before standby mode is automatically assumed after the input signal has stopped being supplied. (See page 21.) |
| CONTROL LOCK | Sets the Monitor so that it cannot be operated with the buttons on itself. (See page 21.) |
| STATUS DISPLAY | Sets if you want the input terminal and the type of signal to be indicated on the screen just after inputs are switched. (See page 22.) |
| SCREEN SAVER | Sets a screen saver. (See page 23.) |
| WHITE BACK | Use to eliminate afterimages on the screen. (See page 22.) |
| VENTILATION MODE | Adjusts the cooling fan speed according to the Monitor mounting method. (See page 23.) |
| WHITE BALANCE | Adjusts R GAIN, G GAIN and B GAIN finely each for "HIGH" and "LOW" settings of the color temperature. (See page 17.) |
| all reset | Resets the Setup Menu settings to defaults. (See page 23.) |
| HOUR METER | Use to confirm the hours of use. (See page 21.) |

Troubleshooting

Solutions to common problems related to the Monitor are described here. If none of the solutions presented here solves the problem, unplug the Monitor and consult an authorized dealer or service center.

| Symptom | Probable cause | Corrective action | Page |
|--|---|--|------|
| Power is not supplied. | • Is the power cord disconnected? | • Insert the power cord (plug) firmly. | 11 |
| | • Is the MAIN POWER switch turned on? | • Turn on the MAIN POWER switch. | 12 |
| Video image does not appear, or audio sound does not occur. | • Is the correct input selected? | • Select the correct input by pressing VIDEO A, VIDEO B, COMPO. and RGB on the remote control (or INPUT on the Monitor). | 12 |
| | • Are connected devices connected correctly? | • Connect connected devices correctly. | 11 |
| | • Are signals being supplied from the connected devices? | • Set connected devices correctly. | 11 |
| | • Are input signals (scanning frequency, etc.) appropriate? | • Check if the signal is appropriate (scanning frequency, etc.), and input the appropriate signal. | 10 |
| | • Is brightness adjusted correctly? | • Adjust brightness on the menu. | 15 |
| | • Is volume set at minimum? | • Adjust volume. | 12 |
| | • Are the diagnostic lamps turned on? | • Refer to "Self-diagnostic indication," and take an appropriate action. | 29 |
| The picture through the RGB terminal is blurred. | _____ | • Adjust CLOCK PHASE using the menu. | 14 |
| Colour is abnormally dark or bright. | • Is brightness adjusted correctly? | • Adjust BRIGHT (brightness) using the menu. | 15 |
| Colour is poor or unstable. | • Is picture quality (colour density, etc.) adjusted correctly? | • Adjust PICTURE using the menu. | 15 |
| | • Is the correct broadcast system (colour system) selected? | • Set SIGNAL MODE (colour system) to "AUTO." | 19 |
| | • Are signals (scanning frequency, etc.) to connected devices appropriate? | • Check if the signal is appropriate (scanning frequency, etc.), and input the appropriate signal. | 10 |
| The picture is cut or shifted toward one side. | • Is the size or position of the screen adjusted properly? | • Adjust H.SIZE, V.SIZE, H.POSITION or V.POSITION using the menu. | 14 |
| The remote control does not work. | • Are the batteries correctly set? | • Insert batteries correctly, observing the polarities (⊕ and ⊖). | 8 |
| | • Are the batteries exhausted? | • Replace with new batteries. | 8 |
| | • Is there any object blocking the path between the remote control and remote sensor? | • Remove any blocking object. | — |
| | • Is the Monitor too far away from you? | • Move toward the Monitor, then operate the remote control. | — |
| | • Is the Monitor connected serially to another Monitor (Serial Connection)? | • Only Master Monitor can be controlled by the remote control when connected serially. | 24 |
| The buttons on the Monitor do not work. | • Is the Control Lock function in use? | • Set the Control Lock function to "OFF" using the menu. | 21 |

Self-diagnostic Indication

The screen monitor may automatically turn off and self-diagnostic lamps next to the power lamp may light or flash. When something abnormal occurs with the Monitor, this function informs you of the condition of the Monitor with self-diagnostic lamps, allowing for smooth service work.

If the self-diagnostic lamps glow or flash in red, use the following procedure before consulting the dealer where you purchased the Monitor.

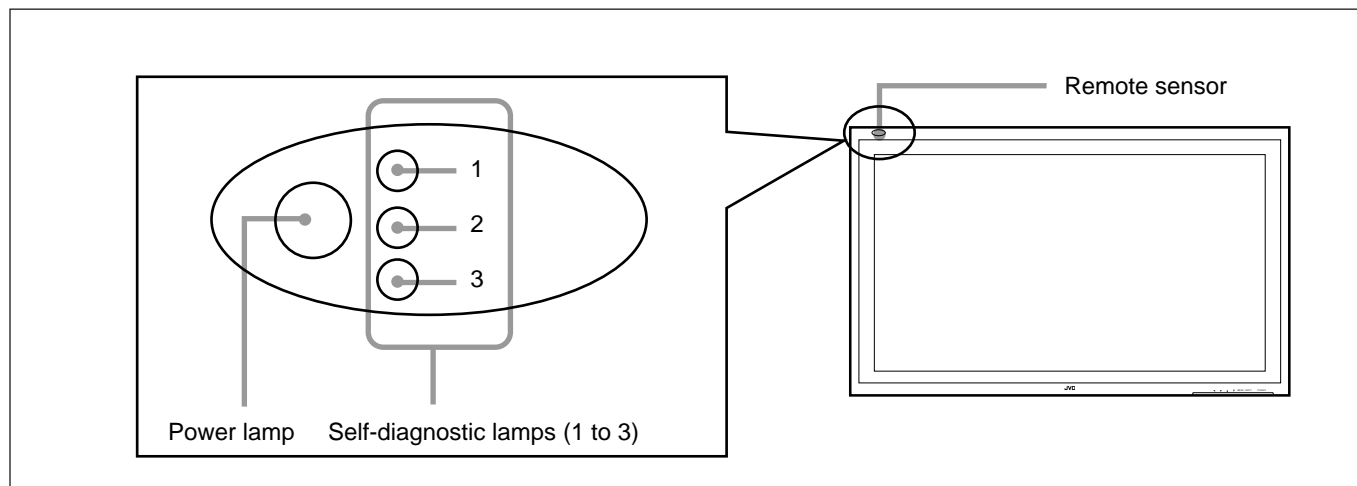

1 Check which lamps are lighting or flashing.

On the Self-diagnostic Report Sheet (below), check the box next to "Lights" or "Flashes" of the corresponding lamp or lamps.

- Depending on a particular case, only one lamp may light or flash, or all three lamps may do so.

2 Turn off the MAIN POWER switch on the back of the Monitor.

3 Unplug the power cord.

4 Call your dealer and tell which lamps are lighting or flashing. (Copy and fax the Self-diagnostic Report Sheet below.)

Note:

- If you turn on the Monitor soon after turning it off (or after recovering from a brief power interruption), the self-diagnostic lamps may light (or flash), and no image may appear on the screen. In this case, turn off the Monitor again, wait for about 10 seconds, then turn it on again. If no self-diagnostic lamps light or flash, you can operate and use the Monitor as usual.

Store name where you purchased the Monitor

To _____

Model Name:

Plasma Display Monitor
 GD-V4200PZW/GD-V4200PZW-G
 GD-V4200PCE/GD-V4200PCE-G

Self-diagnostic Report Sheet

The self-diagnostic lamps light or flash as listed on the following table. Please give me immediate advice or service if necessary.

| Self-diagnostic lamps | | | |
|-----------------------|---------------|---------------------------------|----------------------------------|
| NO. | Lamp position | Conditions | |
| 1 | Upper | <input type="checkbox"/> Lights | <input type="checkbox"/> Flashes |
| 2 | Middle | <input type="checkbox"/> Lights | <input type="checkbox"/> Flashes |
| 3 | Lower | <input type="checkbox"/> Lights | <input type="checkbox"/> Flashes |

| | |
|-----------------------|--|
| Your Name: | |
| Telephone No.: | |
| Address: | |

Specifications

General:

| | |
|----------------------------|--|
| Model name | GD-V4200PZW/GD-V4200PZW-G/GD-V4200PCE/GD-V4200PCE-G |
| Frame colour | GD-V4200PZW/GD-V4200PCE : Silver GD-V4200PZW-G/GD-V4200PCE-G : Gray |
| Screen size | Type 42 wide format |
| Aspect ratio | 16:9 (Wide format) |
| Mass | 36.0 kg (79.2 lbs) |
| External dimensions | 103.5 x 64.0 x 8.9 cm (40 ³ / ₄ x 25 ¹ / ₄ x 3 ⁵ / ₈ inches) (W x H x D) |
| Power requirements | AC 120 V/230 V, 50 Hz/60 Hz |
| Rated input current | 3.9 A (AC 120 V)/2.1 A (AC 230 V) |
| Effective screen size | 92.1 x 51.8 cm (36 ³ / ₈ x 20 ¹ / ₂ inches) (W x H), 105.7 cm (41 ⁵ / ₈ inches) diagonally |
| Number of pixels displayed | 853 (H) x 480 (V) |
| Number of colors displayed | 16.77 million (256 colors for each of RGB) |
| Compatible systems | <ul style="list-style-type: none"> • VIDEO A, B input: NTSC, PAL, SECAM • COMPONENT input: 480i, 576i, 480p, 720p, 1080i |
| Audio output | INTERNAL: 2W + 2W (TYP at impedance 8Ω) EXTERNAL: 3W + 3W (TYP at impedance 6Ω) |
| Speakers | 2 pcs., built-in (4 cm x 7 cm oval-shaped, impedance 8Ω) |
| Operating conditions | Temperature: 0°C to 40°C Relative humidity: 20% to 80% |

Input/output terminals*

| | | | |
|----------------------|--|--|--|
| VIDEO A | <ul style="list-style-type: none"> • Y/C input | Y/C terminal x 1 | Y : 1V(p-p)/75Ω C : 0.286V(p-p)/75Ω for NTSC C : 0.3V(p-p)/75Ω for PAL/SECAM |
| | <ul style="list-style-type: none"> • Video input • Video output • Audio input | BNC terminal x 1 BNC terminal x 1 Pin jack terminal x 2 (L/R), 500mV(rms)/22kΩ or over | 1V(p-p)/75Ω 1V(p-p)/75Ω |
| VIDEO B | <ul style="list-style-type: none"> • Y/C input | Y/C terminal x 1 | Y : 1V(p-p)/75Ω C : 0.286V(p-p)/75Ω for NTSC C : 0.3V(p-p)/75Ω for PAL/SECAM |
| | <ul style="list-style-type: none"> • Video input • Video output • Audio input | BNC terminal x 1 Pin jack terminal x 1 Pin jack terminal x 2 (L/R), 500mV(rms)/22kΩ or over | 1V(p-p)/75Ω 1V(p-p)/75Ω |
| COMPONENT input | <ul style="list-style-type: none"> • BNC terminal x 3 | Y : 1V(p-p)/75Ω P _B /B-Y : 0.7V(p-p)/75Ω P _R /R-Y : 0.7V(p-p)/75Ω | |
| RGB input | <ul style="list-style-type: none"> • D-sub 3 line 15-pin terminal x 1 • Audio input | Video signal : 0.7V(p-p)/75Ω Sync signal : TTL level or 0.3V(p-p)/75Ω Pin jack terminal x 2 (L/R), 500mV(rms)/22kΩ or over | |
| RS232C input | D-sub 9-pin terminal x 1 | | |
| SPEAKER OUT terminal | Impedance 6Ω to 16Ω | | |

Options (not supplied)

| | |
|-------------------------|---|
| Stand Unit | TS-C420P1W, TS-C420P4W, TS-C420P5W, TS-C420P7W |
| Wall Mounting Unit | TS-C420P2W, TS-C420P6W |
| Ceiling suspension Unit | TS-C420P3W |
| Video Interface Kit | IF-C420P1W (Only for GD-V4200PCE and GD-V4200PCE-G) |

* GD-V4200PCE and GD-V4200PCE-G do not have the following input terminals – VIDEO A, VIDEO B, COMPONENT and RGB AUDIO.

Specifications and design are subject to change without notice.

Notice on transportation

This Monitor is precision equipment and needs dedicated packing material for transportation. Never use any packing material supplied from other than JVC or JVC-authorized dealers.

Pin assignment (Specifications for terminals)

• Y/C terminal

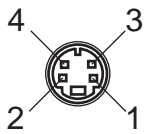

| Pin number | Signal name |
|------------|-------------|
| 1 | GND (Y) |
| 2 | GND (C) |
| 3 | Y |
| 4 | C |

• RS-232C terminal

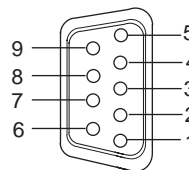

Note:

- This is a female type connector.

| Pin number | Signal name | Pin number | Signal name |
|------------|-------------|------------|-------------|
| 1 | DCD | 6 | DSR |
| 2 | RD | 7 | RTS |
| 3 | TD | 8 | CTS |
| 4 | DTR | 9 | RI |
| 5 | GND | | |

• RGB Input Terminal

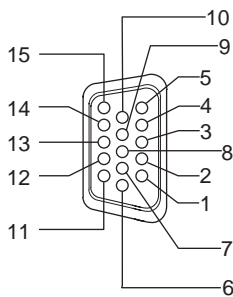

| Pin number | Signal name | Pin number | Signal name |
|------------|-------------|------------|-------------|
| 1 | Red | 9 | N/C |
| 2 | Green | 10 | GND |
| 3 | Blue | 11 | GND |
| 4 | N/C | 12 | N/C |
| 5 | GND | 13 | H.SYNC |
| 6 | GND | 14 | V.SYNC |
| 7 | GND | 15 | N/C |
| 8 | GND | External | GND |

Dimensions

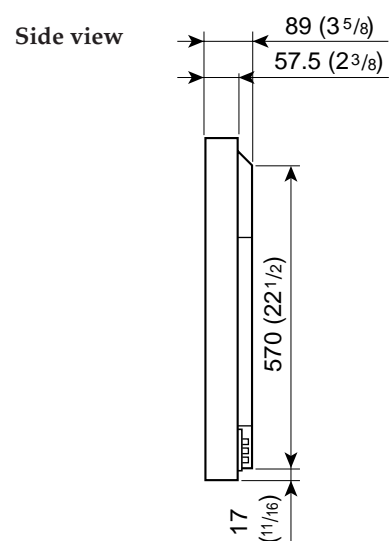
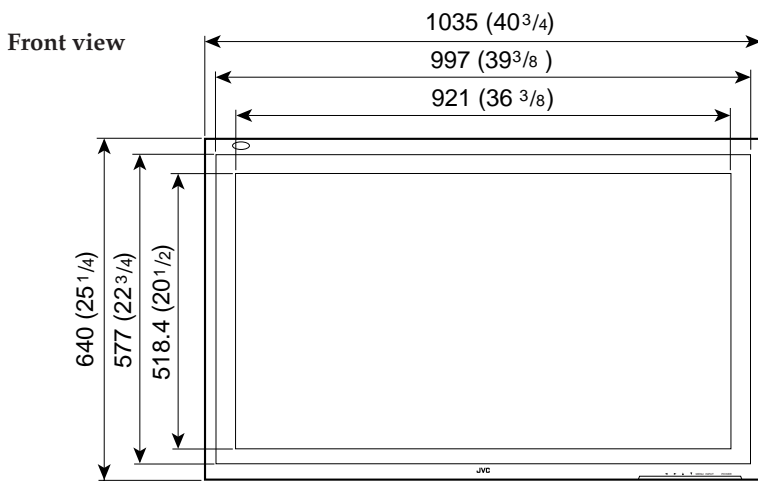
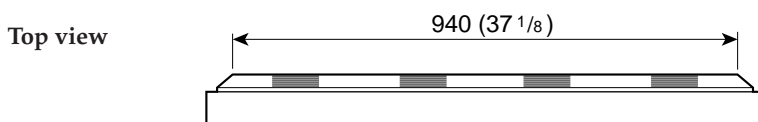

Unit: mm (inch)

JVC