

USER MANUAL

Pro Lite

LCD Monitor

Pro Lite H511S

Thank you very much for choosing the iiyama LCD monitor.

We recommend that you take a few minutes to read carefully through this brief but comprehensive manual before installing and switching on the monitor. Please keep this manual in a safe place for your future reference.

ENGLISH

DEUTSCH

FRANCAIS

NEDERLANDS

SVENSKA

ITALIANO

日本語

TCO Development



Congratulations!

The display you have just purchased carries the TCO'03 Displays label. This means that your display is designed, manufactured and tested according to some of the strictest quality and environmental requirements in the world. This makes for a high performance product, designed with the user in focus that also minimizes the impact on our natural environment.

Some of the features of the TCO'03 Display requirements:

Ergonomics

- Good visual ergonomics and image quality in order to improve the working environment for the user and to reduce sight and strain problems. Important parameters are luminance, contrast, resolution, reflectance, colour rendition and image stability.

Energy

- Energy-saving mode after a certain time – beneficial both for the user and the environment
- Electrical safety

Emissions

- Electromagnetic fields
- Noise emissions

Ecology

- The product must be prepared for recycling and the manufacturer must have a certified environmental management system such as EMAS or ISO 14 001
- Restrictions on
 - o chlorinated and brominated flame retardants and polymers
 - o heavy metals such as cadmium, mercury and lead.

The requirements included in this label have been developed by TCO Development in cooperation with scientists, experts, users as well as manufacturers all over the world. Since the end of the 1980s TCO has been involved in influencing the development of IT equipment in a more user-friendly direction. Our labelling system started with displays in 1992 and is now requested by users and IT-manufacturers all over the world.

For more information, please visit
www.tcodevelopment.com



Congratulations!

You have just purchased a TCO'99 approved and labelled product! Your choice has provided you with a product developed for professional use. Your purchase has also contributed to reducing the burden on the environment and also to the further development of environmentally adapted electronics products.

Why do we have environmentally labelled computers?

In many countries, environmental labelling has become an established method for encouraging the adaptation of goods and services to the environment. The main problem, as far as computers and other electronics equipment are concerned, is that environmentally harmful substances are used both in the products and during their manufacture. Since it is not so far possible to satisfactorily recycle the majority of electronics equipment, most of these potentially damaging substances sooner or later enter nature.

There are also other characteristics of a computer, such as energy consumption levels, that are important from the viewpoints of both the work (internal) and natural (external) environments. Since all methods of electricity generation have a negative effect on the environment (e.g. acidic and climate-influencing emissions, radioactive waste), it is vital to save energy. Electronics equipment in offices is often left running continuously and thereby consumes a lot of energy.

What does labelling involve?

This product meets the requirements for the TCO'99 scheme which provides for international and environmental labelling of personal computers. The labelling scheme was developed as a joint effort by the TCO (The Swedish Confederation of Professional Employees), Svenska Naturskyddsforeningen (The Swedish Society for Nature Conservation) and Statens Energimyndighet (The Swedish National Energy Administration).

Approval requirements cover a wide range of issues: environment, ergonomics, usability, emission of electric and magnetic fields, energy consumption and electrical and fire safety.

The environmental demands impose restrictions on the presence and use of heavy metals, brominated and chlorinated flame retardants, CFCs (freons) and chlorinated solvents, among other things. The product must be prepared for recycling and the manufacturer is obliged to have an environmental policy which must be adhered to in each country where the company implements its operational policy.

The energy requirements include a demand that the computer and/or display, after a certain period of inactivity, shall reduce its power consumption to a lower level in one or more stages. The length of time to reactivate the computer shall be reasonable for the user.

Labelled products must meet strict environmental demands, for example, in respect of the reduction of electric and magnetic fields, physical and visual ergonomics and good usability.

Below you will find a brief summary of the environmental requirements met by this product. The complete environmental criteria document may be ordered from:

TCO Development

SE-114 94 Stockholm, Sweden

Fax: +46 8 782 92 07

Email (Internet): development@tco.se

Current information regarding TCO'99 approved and labelled products may also be obtained via the Internet, using the address: <http://www.tco-info.com/>

Environmental requirements

Flame retardants

Flame retardants are present in printed circuit boards, cables, wires, casings and housings. Their purpose is to prevent, or at least to delay the spread of fire. Up to 30% of the plastic in a computer casing can consist of flame retardant substances. Most flame retardants contain bromine or chloride, and those flame retardants are chemically related to another group of environmental toxins, PCBs. Both the flame retardants containing bromine or chloride and the PCBs are suspected of giving rise to severe health effects, including reproductive damage in fish-eating birds and mammals, due to the bio-accumulative* processes. Flame retardants have been found in human blood and researchers fear that disturbances in foetus development may occur.

The relevant TCO'99 demand requires that plastic components weighing more than 25 grams must not contain flame retardants with organically bound bromine or chlorine. Flame retardants are allowed in the printed circuit boards since no substitutes are available.

Cadmium**

Cadmium is present in rechargeable batteries and in the colour-generating layers of certain computer displays. Cadmium damages the nervous system and is toxic in high doses. The relevant TCO'99 requirement states that batteries, the colour-generating layers of display screens and the electrical or electronics components must not contain any cadmium.

Mercury**

Mercury is sometimes found in batteries, relays and switches. It damages the nervous system and is toxic in high doses. The relevant TCO'99 requirement states that batteries may not contain any mercury. It also demands that mercury is not present in any of the electrical or electronics components associated with the labelled unit.

CFCs (freons)

The relevant TCO'99 requirement states that neither CFCs nor HCFCs may be used during the manufacture and assembly of the product. CFCs (freons) are sometimes used for washing printed circuit boards. CFCs break down ozone and thereby damage the ozone layer in the stratosphere, causing increased reception on earth of ultraviolet light with e.g. increased risks of skin cancer (malignant melanoma) as a consequence.

Lead**

Lead can be found in picture tubes, display screens, solders and capacitors. Lead damages the nervous system and in higher doses, causes lead poisoning. The relevant TCO'99 requirement permits the inclusion of lead since no replacement has yet been developed.

* *Bio-accumulative is defined as substances which accumulate within living organisms*

** *Lead, Cadmium and Mercury are heavy metals which are Bio-accumulative.*

FCC DECLARATION OF CONFORMITY

Model Number: PLH511S
Trade Name: iiyama
Responsible party: IIYAMA North America, Inc.
Address: 65 West Street Road, Suite 101B, Warminster, PA18974 U.S.A.
Telephone number: 215-682-9050

This device complies with Part 15 of the FCC Rules. Operation is subject to the following two conditions: (1) This device may not cause harmful interference, and (2) this device must accept any interference received, including interference that may cause undesired operation.

This device has been tested and found to comply with the limits for Class B Personal Computers and peripherals, pursuant to Part 15 of the FCC Rules. These limits are designed to provide reasonable protection against harmful interference when the device is operated in a residential environment. This device generates, uses and can radiate radio frequency energy, and if not installed and used in accordance with the instructions, may cause harmful interference to radio communications. However, there is no guarantee that interference will not occur in a particular installation. If you determine the device does cause harmful interference to radio or television reception (this may be determined by monitoring the interference while turning the device off and on), you are encouraged to try to correct the interference by one of the following measures:

- Reorient or relocate the receiving antenna.
- Increase the separation between the device and receiver.
- Connect the device into an outlet on a circuit different from that to which the receiver is connected.
- Consult the dealer or an experienced radio or TV technician for help.

To meet the FCC requirements, you should use a signal cable with ferrite core at both ends.

CAUTION

Changes or modifications not expressly approved by iiyama could void the users authority to operate the device under FCC compliance regulations.

CANADIAN DEPARTMENT OF COMMUNICATIONS COMPLIANCE STATEMENT

This digital apparatus does not exceed the Class B limits for radio noise emissions from digital apparatus as set out in the radio interference regulation of the Canadian department of communications.

CE MARKING DECLARATION OF CONFORMITY

This LCD monitor complies with the requirements of the EC Directive 89/336/EEC "EMC Directive" and 73/23/EEC "Low Voltage Directive" as amended by Directive 93/68/EEC.

The electro-magnetic susceptibility has been chosen at a level that gives correct operation in residential areas, business and light industrial premises and small-scale enterprises, inside as well as outside of the buildings. All places of operation are characterised by their connection to the public low voltage power supply system.

- We reserve the right to change specifications without notice.
- All trademarks used in this user manual are the property of their respective owners.

TABLE OF CONTENTS

FOR YOUR SAFETY	1
SAFETY PRECAUTIONS	1
SPECIAL NOTES ON LCD MONITORS	3
CUSTOMER SERVICE	3
CLEANING	3
BEFORE YOU OPERATE THE MONITOR	4
FEATURES	5
CHECKING THE CONTENTS OF THE PACKAGE	6
OPTIONAL PARTS	6
CONTROLS AND CONNECTORS	7
CONNECTING YOUR MONITOR	8
COMPUTER SETTING	9
ADJUSTING THE HEIGHT AND THE VIEWING ANGLE	10
PANEL ROTATION	10
OPERATING THE MONITOR	11
ADJUSTMENT MENU CONTENTS	12
SCREEN ADJUSTMENTS	19
POWER MANAGEMENT FEATURE	22
TROUBLE SHOOTING	23
APPENDIX	25
SPECIFICATIONS	25
DIMENSIONS	26
COMPLIANT TIMING	26
CONNECTOR PIN ASSIGNMENT	27

FOR YOUR SAFETY

SAFETY PRECAUTIONS

WARNING

STOP OPERATING THE MONITOR WHEN YOU SENSE TROUBLE

If you notice any abnormal phenomena such as smoke, strange sounds or fumes, unplug the monitor and contact your dealer or iiyama service center immediately. Further use may be dangerous and can cause fire or electric shock.

NEVER REMOVE THE CABINET

High voltage circuits are inside the monitor. Removing the cabinet may expose you to the danger of fire or electric shock.

DO NOT PUT ANY OBJECT INTO THE MONITOR

Do not put any solid objects or liquids such as water into the monitor. In case of an accident, unplug your monitor immediately and contact your dealer or iiyama service center. Using the monitor with any object inside may cause fire, electric shock or damage.

INSTALL THE MONITOR ON A FLAT, STABLE SURFACE

The monitor may cause an injury if it falls or is dropped.

DO NOT USE THE MONITOR NEAR WATER

Do not use where water may be splashed or spilt onto the monitor as it may cause fire or electric shock.

OPERATE UNDER THE SPECIFIED POWER SUPPLY

Be sure to operate the monitor only with the specified power supply. Use of an incorrect voltage will cause malfunction and may cause fire or electric shock.

PROTECT THE CABLES

Do not pull or bend the power cable and signal cable. Do not place the monitor or any other heavy objects on the cables. If damaged, the cables may cause fire or electric shock.

ADVERSE WEATHER CONDITIONS

It is advisable not to operate the monitor during a heavy thunder storm as the continual breaks in power may cause malfunction. It is also advised not to touch the plug in these circumstances as it may cause electric shock.

CAUTION

INSTALLATION LOCATION

Do not install the monitor where sudden temperature changes may occur, or in humid, dusty or smoky areas as it may cause fire, electric shock or damage. You should also avoid areas where the sun shines directly on the monitor.

DO NOT PLACE THE MONITOR IN A HAZARDOUS POSITION

The monitor may topple and cause injury if not suitably located. Please also ensure that you do not place any heavy objects on the monitor, and that all cables are routed such that children may not pull the cables and possibly cause injury.

MAINTAIN GOOD VENTILATION

Ventilation slots are provided to keep the monitor from overheating. Covering the slots may cause fire. To allow adequate air circulation, place the monitor at least 10 cm (or 4 inches) from any walls. Do not remove the tilt stand when operating the monitor. Ventilation slots on the back of the cabinet will be blocked and the monitor may overheat if the stand is removed. This may cause fire or damage. Operating the monitor on its back, side, upside down or on a carpet or any other soft material may also cause damage.

DISCONNECT THE CABLES WHEN YOU MOVE THE MONITOR

When you move the monitor, turn off the power switch, unplug the monitor and be sure the signal cable is disconnected. If you do not disconnect them, it may cause fire or electric shock.

UNPLUG THE MONITOR

If the monitor is not in use for a long period of time it is recommended that it is left unplugged to avoid accidents.

HOLD THE PLUG WHEN DISCONNECTING

To disconnect the power cable or signal cable, always pull it by the plug. Never pull on the cable itself as this may cause fire or electric shock.

DO NOT TOUCH THE PLUG WITH WET HANDS

Pulling or inserting the plug with wet hands may cause electric shock.

WHEN YOU INSTALL THE MONITOR ON YOUR COMPUTER

Be sure the computer is strong enough to hold the weight of the monitor, otherwise, you may damage your computer.

DO NOT PUT FLOPPY DISKS NEAR THE SPEAKERS

Magnetically recorded data, such as on a floppy disk, may become corrupted by the magnetic field produced by the speakers if the disks are placed on or near the speakers.

OTHERS

ERGONOMIC RECOMMENDATIONS

To eliminate eye fatigue, do not operate the monitor against a bright background or in a dark room. For optimal viewing comfort, the monitor should be just below eye level and 40-60 cm (16-24 inches) away from your eyes. When using the monitor over a prolonged time, a ten minute break every hour is recommended as looking at the screen continuously can cause eye strain.

SPECIAL NOTES ON LCD MONITORS

The following symptoms are normal with LCD monitors and do not indicate a problem.

NOTE

- When you first turn on the LCD monitor, the picture may not fit in the display area because of the type of computer that is used. In this case, adjust the picture position to the correct position.
- Due to the nature of the backlight, the screen may flicker during initial use. Turn off the Power Switch and then turn it on again to make sure the flicker disappears.
- You may find slightly uneven brightness on the screen depending on the desktop pattern you use.
- Due to the nature of the LCD screen, an afterimage of the previous screen may remain after switching the image, when the same image is displayed for hours. In this case, the screen is recovered slowly by changing the image or turning off the Power Switch for hours.
- Contact your dealer or iiyama service center for the backlight replacement when the screen is dark, flickering or not lighting up. Never attempt to replace it by yourself.

CUSTOMER SERVICE

NOTE

- The fluorescent light used in the LCD monitor may have to be periodically replaced. For the warranty coverage on this component, please check with local iiyama service center.
- If you have to return your unit for service and the original packaging has been discarded, please contact your dealer or iiyama service center for advice or replacement packaging.

CLEANING

WARNING

- If you drop any materials or liquids such as water into the monitor when cleaning, unplug the power cable immediately and contact your dealer or iiyama service center.

CAUTION

- For safety reasons, turn off the power switch and unplug the monitor before you clean it.

NOTE

- To protect the LCD panel, do not scratch or rub the screen with a hard object.
- Never use any of the following strong solvents. These will damage the cabinet and the LCD screen.

Thinner	Spray-type cleaner
Benzine	Wax
Abrasive cleaner	Acid or Alkaline solvent
- Touching the cabinet with any product made from rubber or plastic for a long time may cause degeneration or loss of paint on the cabinet.

CABINET

Stains can be removed with a cloth lightly moistened with a mild detergent solvent. Then wipe the cabinet with a soft dry cloth.

LCD SCREEN

Periodic cleaning with a soft dry cloth is recommended.

Don't use tissue paper etc. because these will damage the LCD screen.

BEFORE YOU OPERATE THE MONITOR

The monitor functions as a hub when connected to a USB compliant computer and USB peripherals. However, with older operating systems and/or BIOS settings in your computer, the USB hub may not operate. In this case, please contact your computer dealer first for advice.

Please stand the monitor and then remove the stopper on the back of the stand slowly while pushing top face of the stand before you install the monitor. Careful attention is required as the monitor is sprung loaded and may expand quickly when removing it.

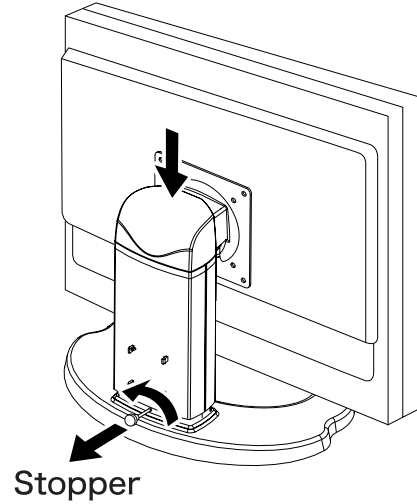

FEATURES

- ◆ 51cm (20.1") TFT Color LCD Monitor
- ◆ Supports Resolutions up to 1600 × 1200
- ◆ High Contrast 400:1 / High Brightness 250cd/m²/Quick Response Time 16ms
- ◆ 17.8mm Narrow Bezel & Slim Design
- ◆ Multi-Color Control
Supports sRGB International Standard
- ◆ Gamma Control
Clear Display for Moving Pictures & Photographs
- ◆ Digital Character Smoothing
- ◆ Automatic Set-up
- ◆ Stereo Speakers
2 × 2W Stereo Speakers & Headphone Connector
- ◆ Economy Mode
Reduced Power Consumption
- ◆ Plug & Play VESA DDC1/2B Compliant
Windows® 95/98/2000/Me/XP Compliant
- ◆ Power Management (ENERGY STAR® and VESA DPMS Compliant)
- ◆ Ergonomic Design
ProLite H511S: TCO '03 and MPR 3 Approved
ProLite H511S-B: TCO '99 and MPR 3 Approved
- ◆ Digital Input (DVI-D) for Clear Display
- ◆ 90° Panel Rotation Design
- ◆ VESA Mounting Standard (100mm×100mm) Compliant

CHECKING THE CONTENTS OF THE PACKAGE

The following accessories are included in your package. Check to see if they are enclosed with the monitor. If anything is missing or damaged, please contact your local iiyama dealer or regional iiyama office.

- Power Cable*
- Audio Cable
- Stand
- Sample: Pivot® & Liquid Series software (CD)
- D-Sub Signal Cable
- User Manual

Pivot®: This software enables to rotate the orientation of the screen to display in portrait or landscape mode.

Liquid View®: This software enables to scale icons up.

Liquid Surf™: This software supports Internet Explorer display.

Consult english.txt in CD-ROM for installation.

CAUTION

* The rating of the Power Cable enclosed in 120V area is 10A/125V. If you are using a power supply higher than this rating, then a power cable with a rating of 10A/250V must be used.

However, all guarantees and warranties are void for any problems or damage caused by a power cable not supplied by iiyama.

OPTIONAL PARTS

Optional parts as below are available for your LCD monitor. Please contact your local iiyama dealer or regional iiyama office for more details. The Protection Sheet may be attached to the LCD panel surface to protect it from stains or scratches.

- Protection Sheet (Parts No. 832Z001-05)

CONTROLS AND CONNECTORS

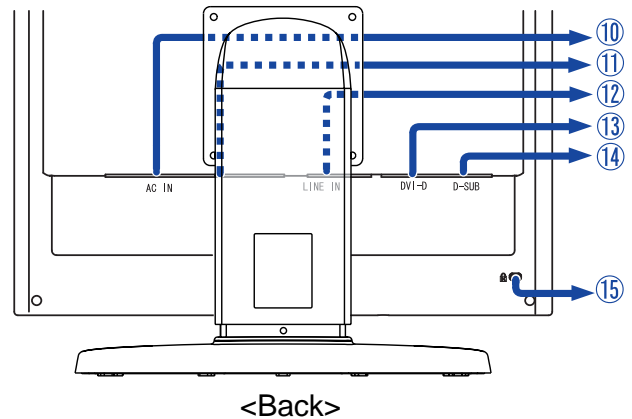
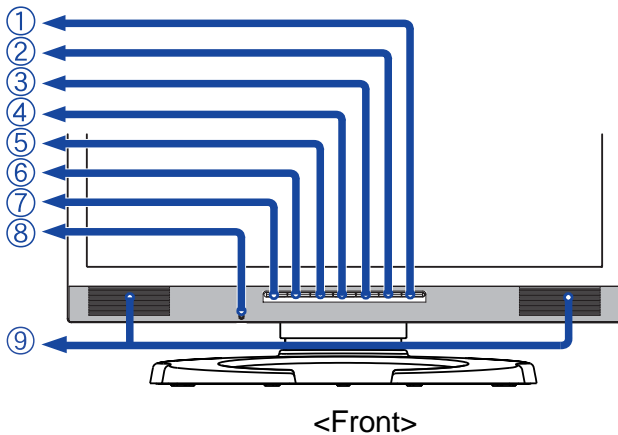

A Power Switch / Power Indicator (POWER)

NOTE

- Green: Normal operation (ProLite H511S)
- Blue: Normal operation (ProLite H511S-B)
- Orange: Power Management

The monitor enters into power management mode which reduces the power consumption to less than 5W when receiving no horizontal and/or vertical sync signal.

B Auto Button (AUTO)

See page 13 for Auto Set-up.

C Exit / Volume Button (EXIT /)

D + / Brightness Button (+ /)

E - / Contrast Button (- /)

F Menu Button (MENU)

G Input Button (INPUT)

Select either Analog or Digital for the signal input when both of the signal inputs are connected to a signal source. Switch D-SUB and DVI-D whenever pressing the input button.

NOTE

When only one of the two signal inputs is connected to the signal source, the one connected is automatically selected. Input Button is not available if there is no signal input from the selected connector or during the power management mode.

H Headphone Connector

I Speakers

J AC Connector (AC IN)

K Main Power Switch

L Audio Connector (LINE IN)

M DVI-D 24pin Connector (DVI-D)

N D-sub mini 15pin Connector (D-SUB)

O Keyhole for Security Lock

NOTE

You can fasten a security lock and cable to prevent the monitor from being removed without your permission.

CONNECTING YOUR MONITOR

- A Ensure that both the computer and the monitor are switched off.
- B Connect the computer to the monitor with the signal cable. (See page 27 for CONNECTOR PIN ASSIGNMENT.)
- C Connect the monitor to the audio equipment with the Audio Cable when using the audio features.
- D Connect the Power Cable to the monitor first and then to the power supply.

NOTE

- The signal cables used for connecting the computer and monitor may vary with the type of computer used. An incorrect connection may cause serious damage to both the monitor and the computer. The cable supplied with the monitor is for a standard 15 pin D-Sub connector. If a special cable is required please contact your local iiyama dealer or regional iiyama office.
- For connection to Macintosh computers, contact your local iiyama dealer or regional iiyama office for a suitable adaptor.
- Make sure you tighten the finger screws at each end of the signal cable.

[Example of Connection]

<Back>

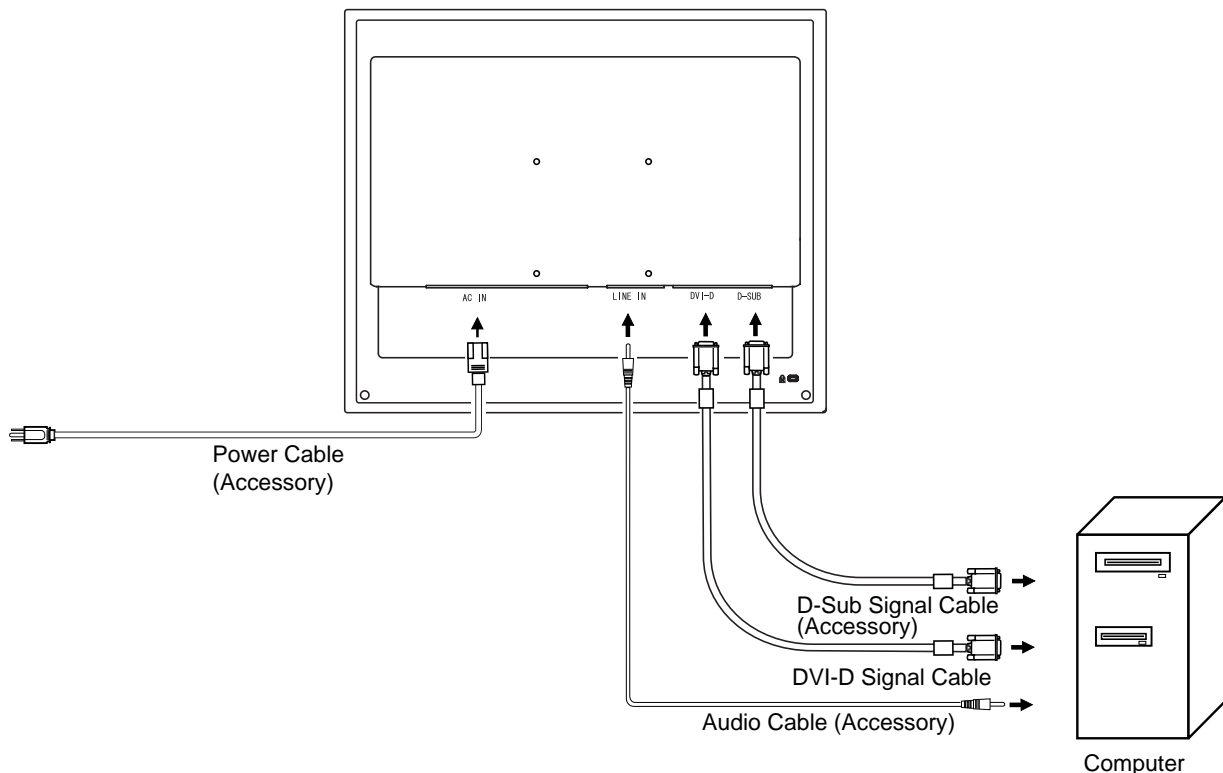

[Cable Wiring]

- A Collect cable at the back of the stand.
- B Hook the cable cover to the back of the stand.

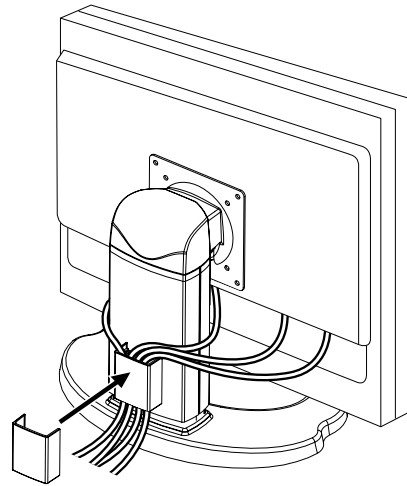

COMPUTER SETTING

■ Signal Timing

Change to the desired signal timing listed on page 26: COMPLIANT TIMING.

■ Windows 95/98/2000/Me/XP Plug & Play

The iiyama LCD monitor complies with DDC1/2B of VESA standard. The Plug & Play function runs on Windows 95/98/2000/Me/XP by connecting the monitor to DDC1/2B compliant computer with the Signal Cable supplied. Windows 95/98/2000/Me/XP Monitor Information File for iiyama monitors may be necessary for your computer and obtained via the Internet, using the address:

<http://www.iiyama.com>

NOTE

- For additional information on how to download the driver for your monitor, please access one of the internet sites noted above.
- Monitor Drivers are not required in most cases for Macintosh or Unix operating systems. For further information, please contact your computer dealer first for advice.

ADJUSTING THE HEIGHT AND THE VIEWING ANGLE

- For optimal viewing it is recommended to look at the full face of the monitor, then adjust the monitor's Height and angle to your own preference.
- Hold the stand so that the monitor does not topple when you change the monitor's angle.
- you are able to adjust the monitor's height up to 110mm, angle up to 35degrees right and left, 35 degrees upward, 5 degrees downward.

- NOTE**
- Do not touch the LCD screen when you change the angle. It may cause damage or break the LCD screen.
 - Careful attention is required not to catch your fingers or hands when you change the angle.

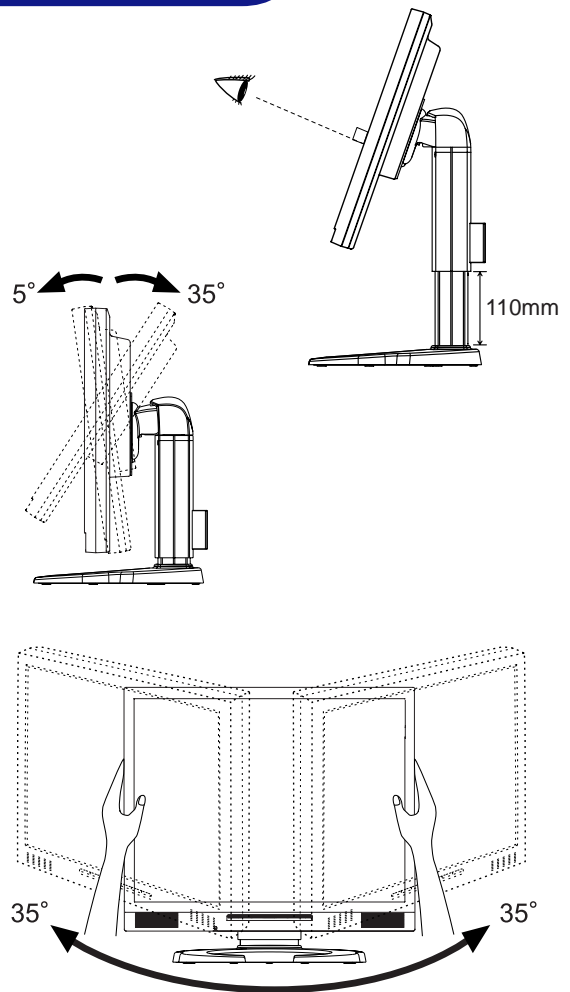

PANEL ROTATION

- A Adjust the monitor's height to the maximum.
- B Rotate the panel 90 degrees.
- Portrait: Turn clockwise.
- Landscape: Turn counter clockwise.

- NOTE**
- Attempting to rotate without fully extending upward may cause damage to stand.
 - Please use attached Pivot® software for rotating the image on the screen.

- C Adjust the monitor's angle to your preference.

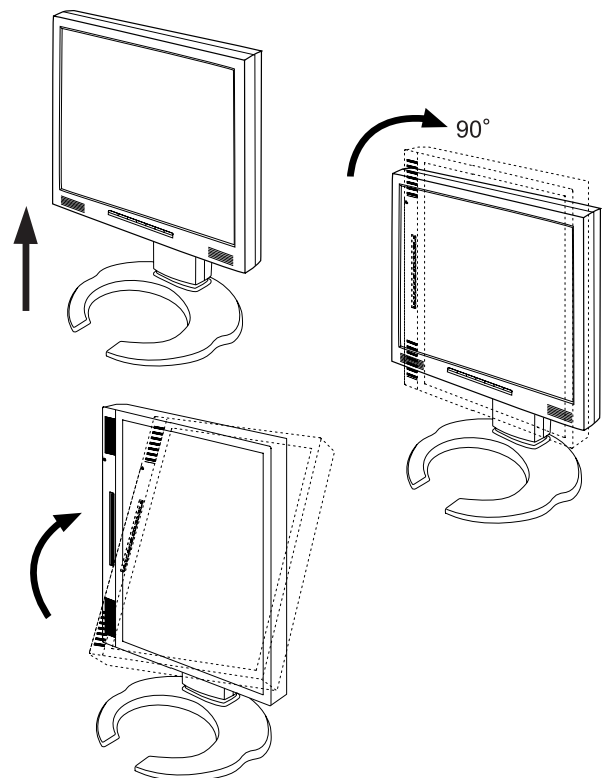

OPERATING THE MONITOR

To create the best picture, your iiyama LCD monitor has been preset at the factory with the COMPLIANT TIMING shown on page 26. You are also able to adjust the picture by following the button operation shown below. For more detailed adjustments, see page 19 for SCREEN ADJUSTMENTS.

- (Press the Menu Button to start the On Screen Display feature. There are additional Menu pages which can be switched by using the +/- Buttons.**

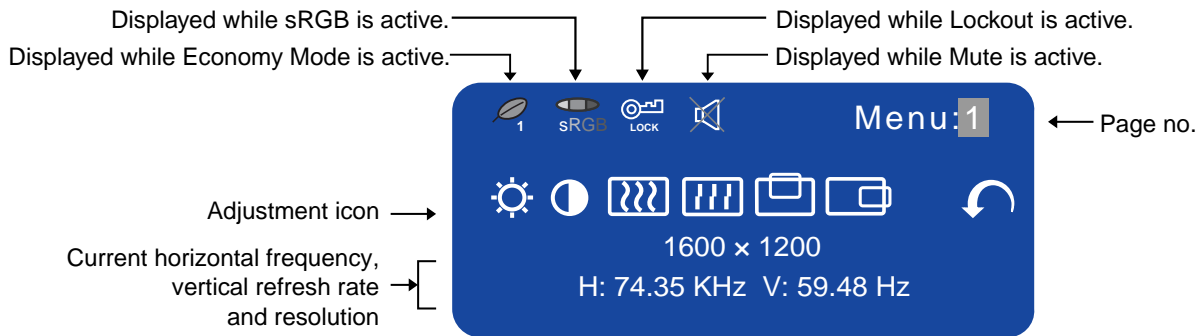

- B Select the Menu page which contains the adjustment icon relating to the adjustment you want to make. Press the Menu Button again. Then, use the +/- Buttons to highlight the desired adjustment icon. Press the Menu Button again.**

- C Use the +/- Buttons to make the appropriate adjustment or setting.**

For example, to correct for vertical position, select Menu page number 1 and then press the Menu Button. Then, select  (V-Position) by using the +/- Buttons.

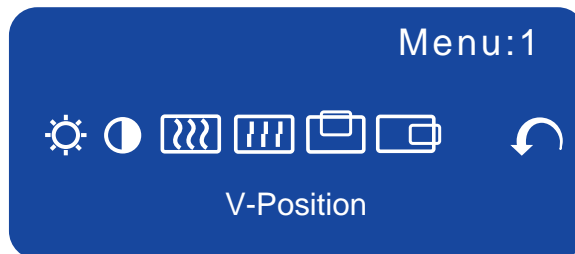

An adjustment scale appears after you press the Menu Button. Use the +/- Buttons to change the vertical position settings. The vertical position of the overall display should be changing accordingly while you are doing this.



NOTE









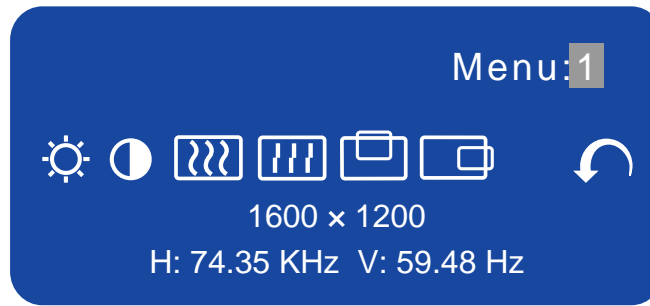









- The On Screen Display disappears several seconds after you stop pressing the buttons while performing an adjustment. The Exit Button can be used to exit OSD window immediately.
- Any changes are automatically saved in the memory when the On Screen Display disappears. Turning off the power should be avoided while using the Menu.
- Adjustments for Clock, Phase and Position are saved for each signal timing. Except for these adjustments, all other adjustments have only one setting which applies to all signal timings.

ADJUSTMENT MENU CONTENTS

Analog Input

Menu : 1
(Analog)



Adjustment Item	Problem / Option	Button to Press
 Brightness *1 Direct	Too dark Too bright	 <input type="button" value="+"/>  <input type="button" value="-"/>
 Contrast Direct	Too dull Too intense	 <input type="button" value="+"/>  <input type="button" value="-"/>
 Clock *2	To correct flickering text or lines	 <input type="button" value="+"/>  <input type="button" value="-"/>
 Phase *2	To correct flickering text or lines	 <input type="button" value="+"/>  <input type="button" value="-"/>
 V-Position	<input type="checkbox"/> Too low <input type="checkbox"/> Too high	 <input type="button" value="+"/>  <input type="button" value="-"/>
 H-Position	<input type="checkbox"/> Too far to the left <input type="checkbox"/> Too far to the right	 <input type="button" value="+"/>  <input type="button" value="-"/>
 Return to Menu	Highlight "Menu : 1" again.	

*1 Adjust the Brightness when you are using the monitor in a dark room and feel the screen is too bright.

*2 See page 19 for SCREEN ADJUSTMENTS.

Direct

You can skip the Menu pages and display an adjustment scale directly by using the following button operations.

- Brightness: Press the Brightness Button when the Menu is not displayed.
- Contrast: Press the Contrast Button when the Menu is not displayed.

Menu : 2
(Analog)

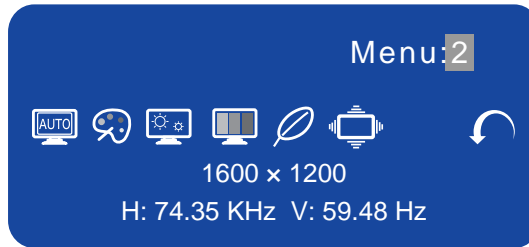

Adjustment Item	Problem / Option		Button to Press	
Auto Set-up *3 Direct	NO	Return to Menu.		
	YES	Adjust Clock, Phase, V-Position and H-Position automatically.		
	Setting	Off	The Auto Set-up is not performed when the signal input is changed.	
		On	Adjust Clock, Phase, V-Position and H-Position automatically when the signal input is changed.	

NOTE

- The brightness of screen varies for several seconds during the adjustment.
- This function is not performed automatically when changing the signal input because the factory-preset of “Setting” in Auto Set-up is set to Off.

Color Temp.	Cold	Bluish white				
	Center	Normal white				
	Warm	Warmer white				
	s	sRGB				
	(User)		<table border="1"> <tr> <td>R</td> <td rowspan="3"> Too weak + Too strong - </td> </tr> <tr> <td>G</td> </tr> <tr> <td>B</td> </tr> </table>	R	Too weak + Too strong -	G
R	Too weak + Too strong -					
G						
B						

NOTE

- sRGB is an international standard which defines and unifies the difference of color appearance between equipment.
- You can not adjust the Gamma and Economy Mode during sRGB mode because those settings are locked.
- is displayed while sRGB is active.





Sharpness	1 2 3 4 5 + -
Adjust the picture quality at resolutions of less than 1600x 1200. You can change the picture quality from 1 to 5 (sharp to soft). Press the + Button to change the picture quality in numerical order. Press the – Button to change the picture quality in reverse numerical order.	

*3 For best results, use the Auto Set-up in conjunction with the adjustment pattern. See page 19 for SCREENADJUSTMENTS.

Direct

You can skip the Menu pages and display an adjustment scale directly by using the following button operations.

- Auto Set-up: Press the Auto Button when the Menu is not displayed.

Menu : 2 (Analog)		
Adjustment Item	Problem / Option	
 Gamma	Off	Normal
	Mode1	High contrast
	Mode2	Dark
 Economy Mode Direct	Off	Normal
	Mode1	Brightness of back-light is reduced.
	Mode2	Brightness of back-light is reduced more than Mode1.
NOTE ■  is displayed while Economy Mode is active.		
 Full Screen	Off	The picture is displayed at the optimum resolution.
	1	Stretch the picture and keep the screen size ratio.
	2	Stretch the picture to fit the full screen
NOTE Adjust the screen size at resolutions of less than 1600 × 1200. When selecting “1” or “2” displayed text or lines may be blurred, or brightness may not be uniform when inputting stripe pattern signal or the like.		
 Return to Menu	Highlight “Menu : 2” again.	

Direct

You can skip the Menu pages and display an adjustment scale directly by using the following button operations.

- Economy Mode: When OSD menu is off, holding the Menu button for 1-2 seconds will toggle the Economy Mode switch Off, Mode1 and Mode2.

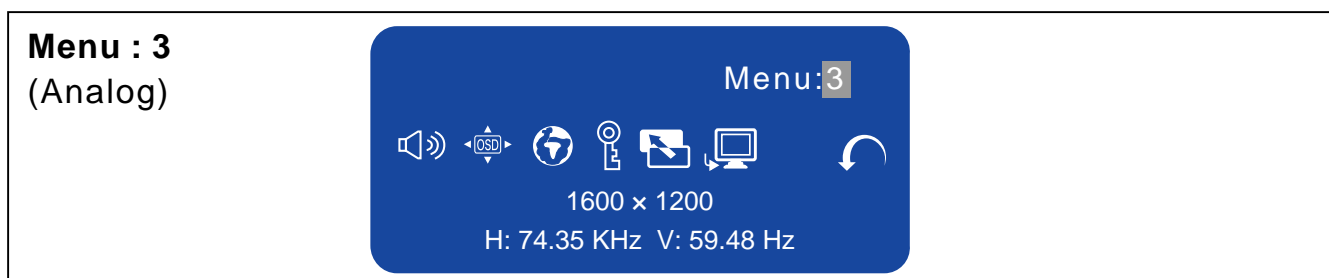

Adjustment Item	Problem / Option		Button to Press									
Volume Direct	Too soft Too loud		+ -									
NOTE ■ is displayed while Mute is active.												
OSD Position	1 2 3 4 5 You can move the OSD display area to any one of the following 5 positions within the overall display: <table border="1" style="display: inline-table; margin-left: 20px;"> <tr><td>1</td><td>---</td><td>4</td></tr> <tr><td>---</td><td>3</td><td>---</td></tr> <tr><td>2</td><td>---</td><td>5</td></tr> </table>		1	---	4	---	3	---	2	---	5	+ -
1	---	4										
---	3	---										
2	---	5										
Language	English	English										
	Deutsch	German										
	Français	French										
	Español	Spanish										
	Italiano	Italian										
Lockout	Off	Lockout is canceled.										
	On	All adjustment items except this function are locked out.										
NOTE ■ is displayed while Lockout is active.												
Reset	NO	Return to Menu.										
	YES	Factory-preset data is restored.										
Signal Select Direct	Analog	Select the Analog input (D-SUB).										
	Digital	Select the Digital input (DVI-D).										
Return to Menu	Highlight "Menu : 3" again.											

Direct









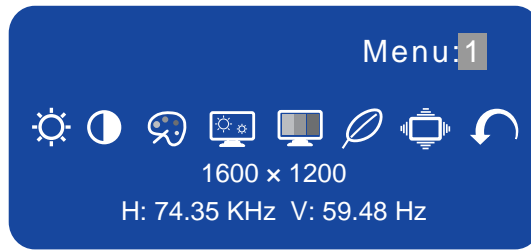











You can skip the Menu pages and display an adjustment scale directly by using the following button operations.

- Volume: Press the Volume Button when the Menu is not displayed. Holding the Volume Button for 1-2 seconds will switch the Mute function between ON and OFF.
- Signal Select: Press the Input Button when the Menu is not displayed.

Digital Input

Menu : 1 (Digital)







Adjustment Item	Problem / Option	Button to Press			
 Brightness *1 Direct	Too dark	 			
	Too bright	 			
 Contrast Direct	Too dull	 			
	Too intense	 			
 Color Temp.	Cold	Bluish white			
	Center	Normal white			
	Warm	Warmer white			
	s	sRGB			
	 (User)	  <table border="1" style="display: inline-table; vertical-align: middle;"> <tr><td>R</td></tr> <tr><td>G</td></tr> <tr><td>B</td></tr> </table>	R	G	B
R					
G					
B					
NOTE <ul style="list-style-type: none"> ■ sRGB is an international standard which defines and unifies the difference of color appearance between equipment. ■ You can not adjust the Gamma and Economy Mode during sRGB mode because those settings are locked. ■  is displayed while sRGB is active. 					
 Sharpness	1 2 3 4 5 <table border="1" style="display: inline-table; vertical-align: middle;"> <tr><td>+</td></tr> <tr><td>-</td></tr> </table>	+	-	   	
+					
-					
 Gamma	Off	Normal			
	Mode1	High contrast			
	Mode2	Dark			

*1 Adjust the Brightness when you are using the monitor in a dark room and feel the screen is too bright.

Direct

You can skip the Menu pages and display an adjustment scale directly by using the following button operations.

- Brightness: Press the Brightness Button when the Menu is not displayed.
- Contrast: Press the Contrast Button when the Menu is not displayed.

Menu : 1 (Digital)		
Adjustment Item	Problem / Option	
 Economy Mode Direct	Off	Normal
	Mode1	Brightness of back-light is reduced.
	Mode2	Brightness of back-light is reduced more than Mode1.
NOTE ■  is displayed while Economy Mode is active.		
 Full Screen	Off	The picture is displayed at the optimum resolution.
	1	Stretch the picture and keep the screen size ratio.
	2	Stretch the picture to fit the full screen
NOTE Adjust the screen size at resolutions of less than 1600 × 1200. When selecting “1” or “2” displayed text or lines may be blurred, or brightness may not be uniform when inputting stripe pattern signal or the like.		
 Return to Menu	Highlight “Menu : 1” again.	

Direct

You can skip the Menu pages and display an adjustment scale directly by using the following button operations.

- Economy Mode: When OSD menu is off, holding the Menu button for 1-2 seconds will toggle the Economy Mode switch Off, Mode1 and Mode2.

Menu : 2
(Digital)

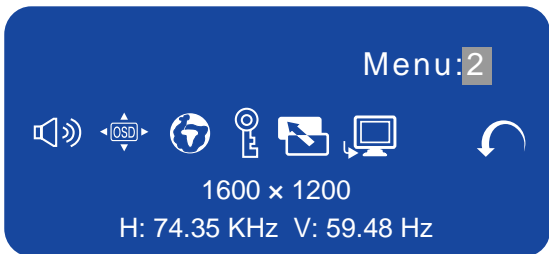

Adjustment Item	Problem / Option		Button to Press
Volume Direct	Too soft Too loud		+ -
NOTE ■ is displayed while Mute is active.			
OSD Position	1 2 3 4 5 You can move the OSD display area to any one of the following 5 positions within the overall display:		+ -
Language	English	English	
	Deutsch	German	
	Français	French	
	Español	Spanish	
	Italiano	Italian	
	日本語	Japanese	
Lockout	Off	Lockout is canceled.	
	On	All adjustment items except this function are locked out.	
NOTE ■ is displayed while Lockout is active.			
Reset	NO	Return to Menu.	
	YES	Factory-preset data is restored.	
Signal Select Direct	Analog	Select the Analog input (D-SUB).	
	Digital	Select the Digital input (DVI-D).	
Return to Menu	Highlight "Menu : 2" again.		

Direct

You can skip the Menu pages and display an adjustment scale directly by using the following button operations.

- Volume: Press the Volume Button when the Menu is not displayed. Holding the Volume Button for 1-2 seconds will switch the Mute function between ON and OFF.
- Signal Select: Press the Input Button when the Menu is not displayed.

SCREEN ADJUSTMENTS

Adjust the image by following the procedure below to get the desired picture when selecting Analog input.

- The screen adjustments described in this manual are designed to set image position and minimize flicker or blur for the particular computer in use.
- The monitor is designed to provide the best performance at resolution of 1600 × 1200, but can not provide the best at resolutions of less than 1600 × 1200 because the picture is automatically stretched to fit the full screen. It is recommended to operate at resolution of 1600 × 1200 in normal use.
- Displayed text or lines will be blurred or irregular in thickness when the picture is stretched due to the screen enlargement process.
- It is preferable to adjust the image position and frequency with the monitor controls, rather than the computer software or utilities.
- Perform adjustments after a warm-up period of at least thirty minutes.
- Additional adjustments may be required after the Auto Set-up depending on the resolution or signal timing.
- The Auto Set-up may not work correctly when displaying the picture other than the screen adjustment pattern. In this case, manual adjustments are required.

There are two ways to adjust the screen. One way is automatic adjustment for Clock, Phase and Position. The other way is performing each adjustment manually.

Perform the Auto Set-up first when the monitor is connected to a new computer, or resolution is changed. If the screen has a flicker or blur, or the picture does not fit in the display area after performing the Auto Set-up, manual adjustments are required. Both adjustments should be made by using the screen adjustment pattern (Test.bmp) obtained via the iiyama web site (<http://www.iiyama.com>).

Adjust the image by following the procedure below to get the desired picture.

This manual explains adjustment under Windows 95/98/2000/Me/XP.

A Display the picture at the optimum resolution.

B Enter the Test.bmp (screen adjustment pattern) to wallpaper.

NOTE

- Consult the appropriate documentation for doing this.
- Test.bmp is made at resolution of 1280 × 1024. Set the display position to center in the wallpaper setting dialogue box. If you use Microsoft® PLUS! 95/98 cancel the setting of “Stretch desktop wallpaper to fit the screen”.

[Adjustment pattern]

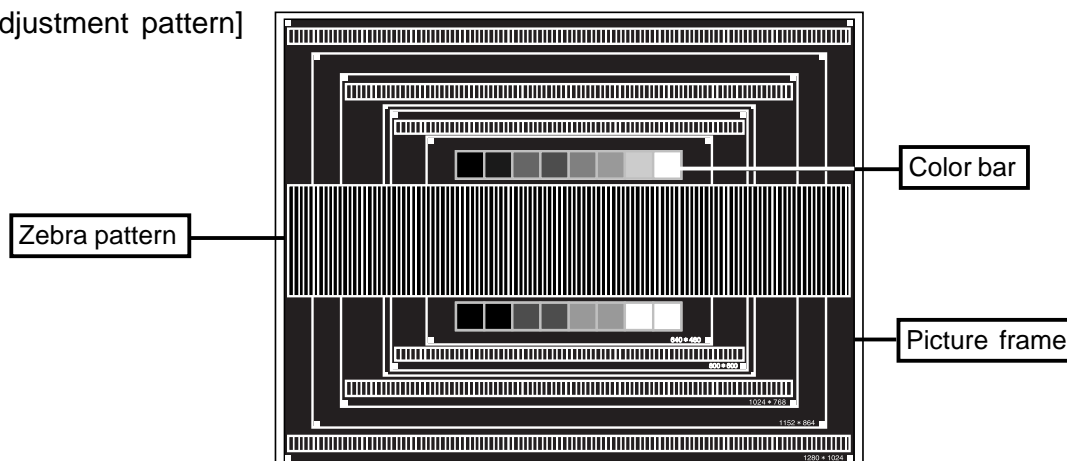

C Press the Auto Button. (Auto Set-up)

D Adjust the image manually by following procedure below when the screen has a flicker or blur, or the picture does not fit in the display area after performing the Auto Set-up.

E Adjust the V-Position so that the top and bottom of the picture frame will fit to the display area.

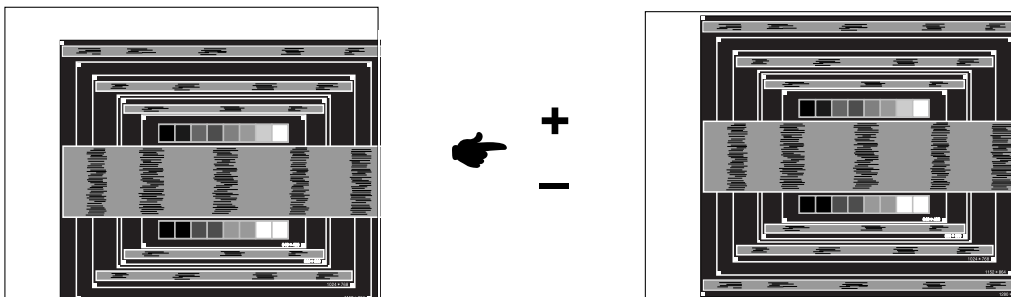

F 1) Adjust the H-Position so that the left side of the picture frame will move to the left edge of the display area.

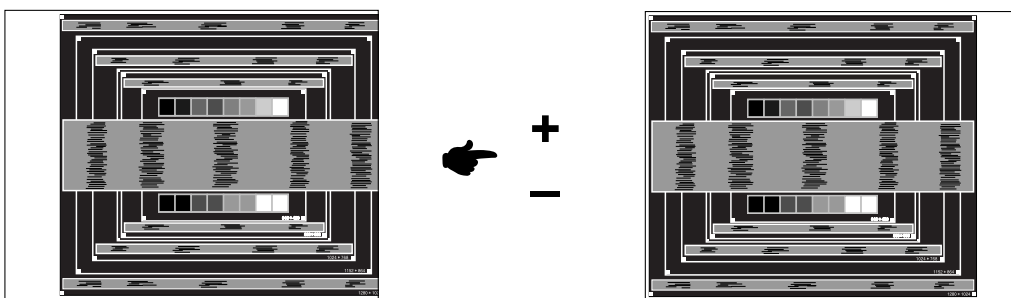

2) Stretch the right side of the picture frame to the right edge of the display area by adjusting the Clock.

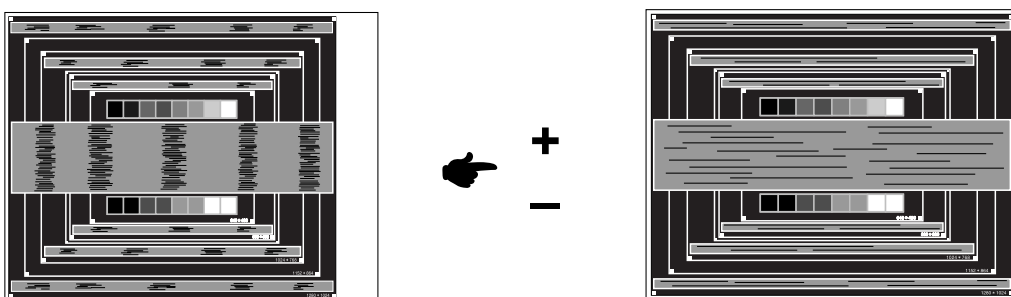

NOTE

- When the left side of the picture frame moves apart from the left edge of the display area during the Clock adjustment, adjust steps 1) and 2).
- Another way to make the Clock adjustment is to correct the vertical wavy lines in the zebra pattern.
- The picture may flicker during the Clock, H-Position and V-Position adjustment.
- In case the picture frame is bigger or smaller than the data display area after the Clock adjustment, repeat steps from C.

G Adjust the Phase to correct horizontal wavy noise, flicker or blur in the zebra pattern.

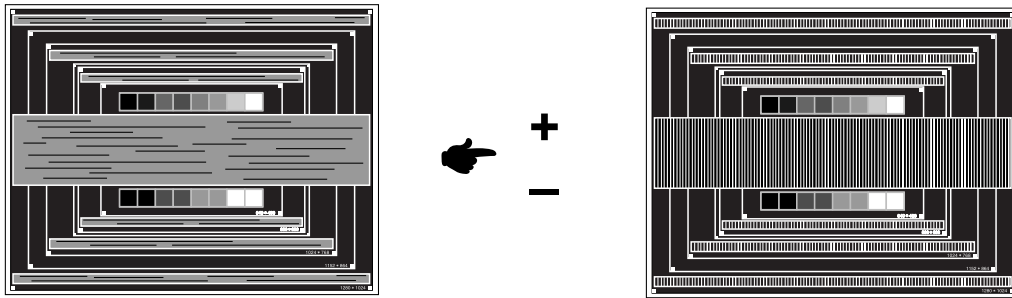

NOTE

- In case the strong flicker or blurs remain on a part of the screen, repeat steps F and G because the Clock may not be adjusted correctly. If the flicker or blurs still remain, set the refresh rate of computer to low (60Hz) and repeat steps from C again.
- Adjust the H-Position after the Phase adjustment if the horizontal position moves during the adjustment.

**H Adjust the Brightness and Color Temp. to get the desired picture after you complete the Clock and Phase adjustments.
Put back your favorite wallpaper.**

POWER MANAGEMENT FEATURE

The power management feature of this product complies with every power saving requirement of VESA DPMS. When activated, it automatically reduces unnecessary power consumption of the monitor when your computer is not in use.

To use the feature, the monitor needs to be connected to a VESA DPMS compliant computer. There is a power management step the monitor takes as described below. The power management function, including any timer settings is configured by the operating system. Check your operating system manual for information on how this can be configured.

■ Power Management Mode

When the H-sync signal / V-sync signal / H and V sync signals from the computer are off, the monitor enters into Power Management Mode which reduces the power consumption to less than 5W. The screen becomes dark, and the power indicator turns to orange. From Power Management Mode, the image reappears in several seconds when either the keyboard or the mouse are touched again.

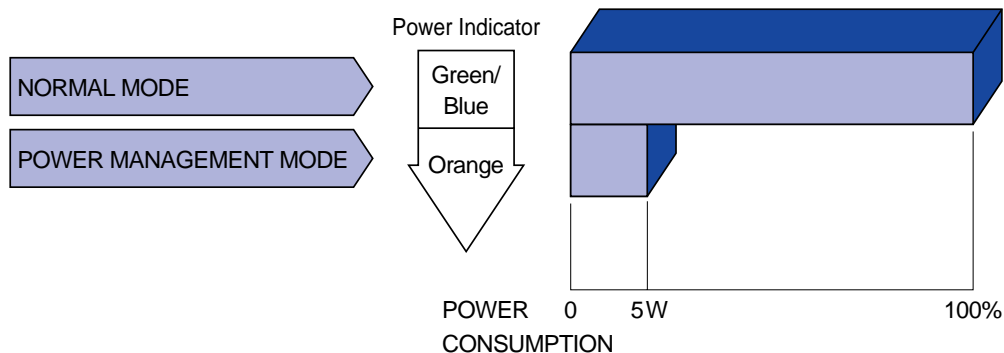

NOTE

- Even when using the power management mode, the monitor consumes electricity. Turn off the Power Switch whenever the monitor is not in use, during the night and weekends, to avoid unnecessary power consumption.
- It is possible that the video signal from the computer may be on while the H or V sync signal is missing. In this instance, the POWER MANAGEMENT feature may not work properly.

TROUBLE SHOOTING

If the monitor fails to operate correctly, please follow the steps below for a possible solution.

1. Perform the adjustments described in OPERATING THE MONITOR, depending on the problem you have. If the monitor does not get a picture, skip to 2.
2. Consult the following items if you cannot find an appropriate adjustment item in OPERATING THE MONITOR or if the problem persists.
3. If you are experiencing a problem which is not described below or you cannot correct the problem, discontinue using the monitor and contact your dealer or iiyama service center for further assistance.

Problem	Check
A The picture does not appear. (Power indicator does not light up.) (Power indicator is green/blue.) (Power indicator is orange.)	<input type="checkbox"/> The Power Cable is firmly seated in the socket. <input type="checkbox"/> The Power Switch is turned ON. <input type="checkbox"/> The AC socket is live. Please check with another piece of equipment. <input type="checkbox"/> If the blank screen saver is in active mode, touch the keyboard or the mouse. <input type="checkbox"/> Increase the Contrast and/or Brightness. <input type="checkbox"/> The computer is ON. <input type="checkbox"/> The Signal Cable is properly connected. <input type="checkbox"/> The signal timing of the computer is within the specification of the monitor. <input type="checkbox"/> If the monitor is in power management mode, touch the keyboard or the mouse. <input type="checkbox"/> The computer is ON. <input type="checkbox"/> The Signal Cable is properly connected. <input type="checkbox"/> The signal timing of the computer is within the specification of the monitor.
B The screen is not synchronized.	<input type="checkbox"/> The Signal Cable is properly connected. <input type="checkbox"/> The signal timing of the computer is within the specification of the monitor. <input type="checkbox"/> The video output level of the computer is within the specification of the monitor.
C The screen position is not in the center.	<input type="checkbox"/> The signal timing of the computer is within the specification of the monitor.
D The screen is too bright or too dark.	<input type="checkbox"/> The video output level of the computer is within the specification of the monitor.
E The screen is shaking.	<input type="checkbox"/> The power voltage is within the specification of the monitor. <input type="checkbox"/> The signal timing of the computer is within the specification of the monitor.

Problem

Check

- | | |
|---------------------------------------|--|
| F No sound. | <input type="checkbox"/> The audio equipment (computer etc.) is ON.
<input type="checkbox"/> The Audio Cable is properly connected.
<input type="checkbox"/> The Volume is turned up.
<input type="checkbox"/> The Mute is OFF.
<input type="checkbox"/> The audio output level of the audio equipment is within the specification of the monitor. |
| G The sound is too loud or too quiet. | <input type="checkbox"/> The audio output level of the audio equipment is within the specification of the monitor. |
| H A strange noise is heard. | <input type="checkbox"/> The Audio Cable is properly connected. |

APPENDIX

SPECIFICATIONS

LCD Panel	Driving system	a-Si TFT Active Matrix
	Size	Diagonal: 51cm / 20.1"
	Pixel pitch	0.255mm H × 0.255mm V
	Brightness	250cd/m ² (Typical)
	Contrast ratio	400 : 1 (Typical)
	Viewable angle	Right / Left / Up / Down: 88 degrees each (Typical)
	Response time	16ms (Black, white, black)
Display Colors	16,777,216 maximum	
Sync Frequency	Analog: Horizontal 24.0-80.0kHz, Vertical 56-85Hz Digital: Horizontal 31.0-80.0kHz, Vertical 56-85Hz	
Dot Clock	162MHz maximum	
Maximum Resolution	1600 × 1200, 1.9 MegaPixels	
Input Connector	D-Sub mini 15pin, DVI-D 24pin	
Plug & Play	VESA DDC1/2B™	
Input Sync Signal	Separate sync: TTL, Positive or Negative Composite sync: TTL, Positive or Negative Sync on green: 0.3Vp-p, Negative	
Input Video Signal	Analog: 0.7Vp-p (Standard), 75Ω, Positive Digital: DVI (Digital Visual Interface Standard Rev.1.0) compliance	
Input Audio Connector	ø 3.5mm mini jack (Stereo)	
Input Audio Signal	1.0Vrms maximum	
Speakers	2.0W × 2 (Stereo speakers)	
Headphone Connector	ø 3.5mm mini jack (Stereo)	
Maximum Screen Size	408mm W × 306mm H / 16.1" W × 12" H	
Power Source	100-240VAC, 50/60Hz, 1.4A	
Power Consumption	85W maximum, Power management mode: 5W maximum*	
Dimensions / Net Weight	446 × 391.5-501.5mm × 242mm / 17.6 × 15.4-19.7 × 9.5" (W×H×D), 10kg / 22lbs	
Tilt Angle	Right / Left: 35 degrees each, Up: 35 degrees, Down: 5 degrees	
Environmental Considerations	Operating: Temperature 5 to 35°C / 41 to 95°F Humidity 20 to 80% (No condensation) Storage: Temperature -20 to 60°C / -4 to 140°F Humidity 5 to 85% (No condensation)	
Approvals	ProLite H511S	TCO '03, CE, TÜV-GS / MPR 3 (prEN50279) / ISO 13406-2, FCC-B, UL / C-UL, VCCI-B, CCC
	ProLite H511S-B	TCO '99, CE, TÜV-GS / MPR 3 (prEN50279) / ISO 13406-2, FCC-B, UL / C-UL, VCCI-B, CCC

NOTE *Condition: Audio equipment is not connected.

DIMENSIONS

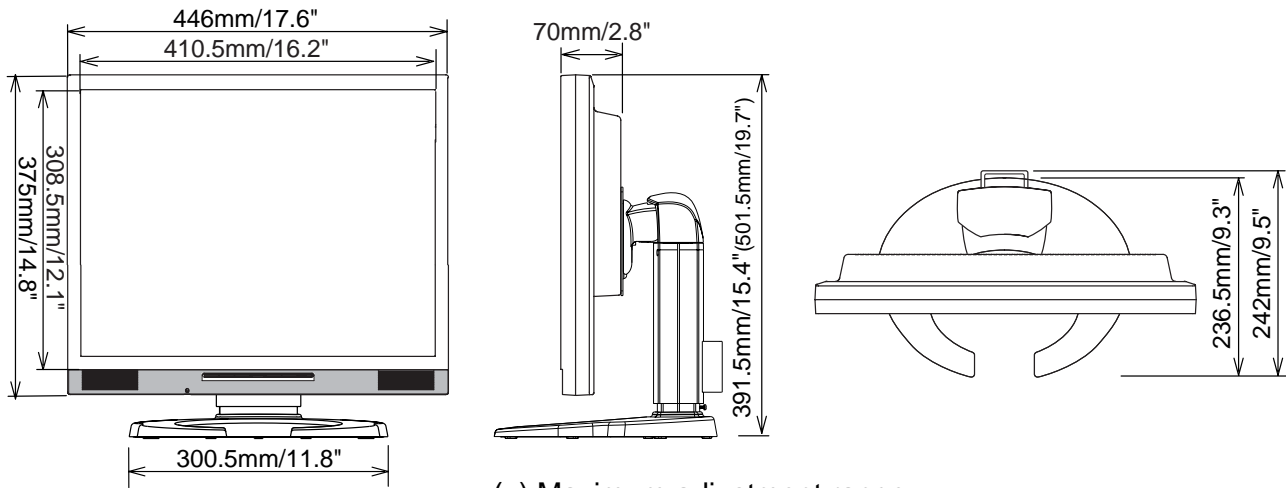

() :Maximum adjustment range

COMPLIANT TIMING

Video Mode		Horizontal Frequency	Vertical Frequency	Dot Clock	
VESA	VGA 640 × 480	31.469kHz	59.940Hz	25.175MHz	
		37.861kHz	72.809Hz	31.500MHz	
		37.500kHz	75.000Hz	31.500MHz	
		43.269kHz	85.008Hz	36.000MHz	
	SVGA 800 × 600	35.156kHz	56.250Hz	36.000MHz	
		37.879kHz	60.317Hz	40.000MHz	
		48.077kHz	72.188Hz	50.000MHz	
		46.875kHz	75.000Hz	49.500MHz	
		53.674kHz	85.061Hz	56.250MHz	
	XGA 1024 × 768	48.363kHz	60.004Hz	65.000MHz	
		56.476kHz	70.069Hz	75.000MHz	
		60.023kHz	75.029Hz	78.750MHz	
		68.677kHz	84.997Hz	94.500MHz	
	SXGA	1152 × 864	67.500kHz	75.000Hz	108.000MHz
			63.981kHz	60.020Hz	108.000MHz
		1280 × 1024	79.976kHz	75.025Hz	135.000MHz
UXGA 1600 × 1200	75.000kHz	60.000Hz	162.000MHz		
VGA TEXT	640 × 400	31.469kHz	70.087Hz	25.175MHz	
Macintosh	640 × 480	35.000kHz	66.667Hz	30.240MHz	
	832 × 624	49.725kHz	74.500Hz	57.283MHz	
	1024 × 768	60.150kHz	74.720Hz	80.000MHz	
PC9801	640 × 400	24.827kHz	56.424Hz	21.053MHz	

NOTE

* DVI input is not compliant.

CONNECTOR PIN ASSIGNMENT

■ D-Sub mini 15pin Connector

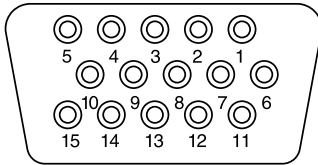

D-SUB

Pin	Input Signal	Pin	Input Signal
1	Red video	9	
2	Green video / Sync on green	10	Ground
3	Blue video	11	Reserved port
4	Reserved port	12	Data line (SDA)*
5	Ground	13	H-Sync/HV-Sync
6	Red video ground	14	V-Sync
7	Green video ground	15	Clock line (SCL)*
8	Blue video ground		* Compliant to VESA DDC.

■ DVI-D 24pin Connector

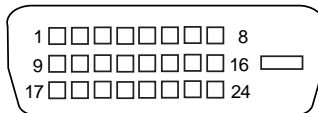

DVI-D

Pin	Input Signal	Pin	Input Signal
1	T.M.D.S Data 2-	13	
2	T.M.D.S Data 2+	14	
3	T.M.D.S Data 2 Ground	15	Ground
4		16	Hot Plug Detect
5		17	T.M.D.S Data 0-
6	Clock line (SCL) *	18	T.M.D.S Data 0+
7	Data line (SDA) *	19	T.M.D.S Data 0 Ground
8		20	
9	T.M.D.S Data 1-	21	
10	T.M.D.S Data 1+	22	T.M.D.S Clock Ground
11	T.M.D.S Data 1 Ground	23	T.M.D.S Clock +
12		24	T.M.D.S Clock -

* Compliant to VESA DDC.