

USER MANUAL

Pro Lite

LCD Monitor

ENGLISH

DEUTSCH

FRANCAIS

日本語

Pro Lite E1700S
Pro Lite E1700SV

Thank you very much for choosing the iiyama LCD monitor.

We recommend that you take a few minutes to read carefully through this brief but comprehensive manual before installing and switching on the monitor. Please keep this manual in a safe place for your future reference.



TCO Development

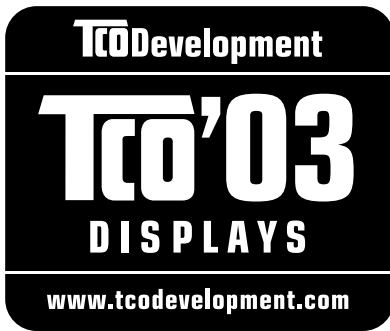

Congratulations!

The display you have just purchased carries the TCO'03 Displays label. This means that your display is designed, manufactured and tested according to some of the strictest quality and environmental requirements in the world. This makes for a high performance product, designed with the user in focus that also minimizes the impact on our natural environment.

Some of the features of the TCO'03 Display requirements:

Ergonomics

- Good visual ergonomics and image quality in order to improve the working environment for the user and to reduce sight and strain problems. Important parameters are luminance, contrast, resolution, reflectance, colour rendition and image stability.

Energy

- Energy-saving mode after a certain time – beneficial both for the user and the environment
- Electrical safety

Emissions

- Electromagnetic fields
- Noise emissions

Ecology

- The product must be prepared for recycling and the manufacturer must have a certified environmental management system such as EMAS or ISO 14 001
- Restrictions on
 - o chlorinated and brominated flame retardants and polymers
 - o heavy metals such as cadmium, mercury and lead.

The requirements included in this label have been developed by TCO Development in cooperation with scientists, experts, users as well as manufacturers all over the world. Since the end of the 1980s TCO has been involved in influencing the development of IT equipment in a more user-friendly direction. Our labelling system started with displays in 1992 and is now requested by users and IT-manufacturers all over the world.

For more information, please visit
www.tcodevelopment.com

FCC DECLARATION OF CONFORMITY

Model Number: PL1700
Trade Name: iiyama
Responsible party: IIYAMA North America, Inc.
Address: 65 West Street Road, Suite 101B, Warminster, PA 18974 U.S.A.
Telephone number: 215-682-9050

This device complies with Part 15 of the FCC Rules. Operation is subject to the following two conditions: (1) This device may not cause harmful interference, and (2) this device must accept any interference received, including interference that may cause undesired operation.

This device has been tested and found to comply with the limits for Class B Personal Computers and peripherals, pursuant to Part 15 of the FCC Rules. These limits are designed to provide reasonable protection against harmful interference when the device is operated in a residential environment. This device generates, uses and can radiate radio frequency energy, and if not installed and used in accordance with the instructions, may cause harmful interference to radio communications. However, there is no guarantee that interference will not occur in a particular installation. If you determine the device does cause harmful interference to radio or television reception (this may be determined by monitoring the interference while turning the device off and on), you are encouraged to try to correct the interference by one of the following measures:

- Reorient or relocate the receiving antenna.
- Increase the separation between the device and receiver.
- Connect the device into an outlet on a circuit different from that to which the receiver is connected.
- Consult the dealer or an experienced radio or TV technician for help.

To meet the FCC requirements, you should use a signal cable with ferrite core at both ends.

CAUTION

Changes or modifications not expressly approved by IIYAMA could void the users authority to operate the device under FCC compliance regulations.

CANADIAN DEPARTMENT OF COMMUNICATIONS COMPLIANCE STATEMENT

This digital apparatus does not exceed the Class B limits for radio noise emissions from digital apparatus as set out in the radio interference regulation of the Canadian department of communications.

CE MARKING DECLARATION OF CONFORMITY

This LCD monitor complies with the requirements of the EC Directive 89/336/EEC "EMC Directive" and 73/23/EEC "Low Voltage Directive" as amended by Directive 93/68/EEC.

The electro-magnetic susceptibility has been chosen at a level that gives correct operation in residential areas, business and light industrial premises and small-scale enterprises, inside as well as outside of the buildings. All places of operation are characterised by their connection to the public low voltage power supply system.

- We reserve the right to change specifications without notice.
- All trademarks used in this user manual are the property of their respective owners.
- As an ENERGY STAR® Partner, iiyama has determined that this product meets the ENERGY STAR® guidelines for energy efficiency.

TABLE OF CONTENTS

FOR YOUR SAFETY	1
SAFETY PRECAUTIONS	1
SPECIAL NOTES ON LCD MONITORS	3
CUSTOMER SERVICE	3
CLEANING	3
BEFORE YOU OPERATE THE MONITOR	4
CHECKING THE CONTENTS OF THE PACKAGE	4
HOW TO USE THE STAND	5
CONTROLS AND CONNECTORS	6
CONNECTING YOUR MONITOR	7
COMPUTER SETTING	8
ADJUSTING THE VIEWING ANGLE	8
OPERATING THE MONITOR	9
ADJUSTMENT MENU CONTENTS	10
SCREEN ADJUSTMENTS	13
POWER MANAGEMENT FEATURE	16
TROUBLE SHOOTING	17
APPENDIX	19
SPECIFICATIONS	19
DIMENSIONS	21
COMPLIANT TIMING	21
CONNECTOR PIN ASSIGNMENT	22

FOR YOUR SAFETY

SAFETY PRECAUTIONS

WARNING

STOP OPERATING THE MONITOR WHEN YOU SENSE TROUBLE

If you notice any abnormal phenomena such as smoke, strange sounds or fumes, unplug the monitor and contact your dealer or iiyama service center immediately. Further use may be dangerous and can cause fire or electric shock.

NEVER REMOVE THE CABINET

High voltage circuits are inside the monitor. Removing the cabinet may expose you to the danger of fire or electric shock.

DO NOT PUT ANY OBJECT INTO THE MONITOR

Do not put any solid objects or liquids such as water into the monitor. In case of an accident, unplug your monitor immediately and contact your dealer or iiyama service center. Using the monitor with any object inside may cause fire, electric shock or damage.

INSTALL THE MONITOR ON A FLAT, STABLE SURFACE

The monitor may cause an injury if it falls or is dropped.

DO NOT USE THE MONITOR NEAR WATER

Do not use where water may be splashed or spilt onto the monitor as it may cause fire or electric shock.

OPERATE UNDER THE SPECIFIED POWER SUPPLY

Be sure to operate the monitor only with the specified power supply. Use of an incorrect voltage will cause malfunction and may cause fire or electric shock.

PROTECT THE CABLES

Do not pull or bend the power cable and signal cable. Do not place the monitor or any other heavy objects on the cables. If damaged, the cables may cause fire or electric shock.

ADVERSE WEATHER CONDITIONS

It is advisable not to operate the monitor during a heavy thunder storm as the continual breaks in power may cause malfunction. It is also advised not to touch the plug in these circumstances as it may cause electric shock.

CAUTION

INSTALLATION LOCATION

Do not install the monitor where sudden temperature changes may occur, or in humid, dusty or smoky areas as it may cause fire, electric shock or damage. You should also avoid areas where the sun shines directly on the monitor.

DO NOT PLACE THE MONITOR IN A HAZARDOUS POSITION

The monitor may topple and cause injury if not suitably located. Please also ensure that you do not place any heavy objects on the monitor, and that all cables are routed such that children may not pull the cables and possibly cause injury.

MAINTAIN GOOD VENTILATION

Ventilation slots are provided to keep the monitor from overheating. Covering the slots may cause fire. To allow adequate air circulation, place the monitor at least 10 cm (or 4 inches) from any walls. Do not remove the tilt stand when operating the monitor. Ventilation slots on the back of the cabinet will be blocked and the monitor may overheat if the stand is removed. This may cause fire or damage. Operating the monitor on its back, side, upside down or on a carpet or any other soft material may also cause damage.

DISCONNECT THE CABLES WHEN YOU MOVE THE MONITOR

When you move the monitor, turn off the power switch, unplug the monitor and be sure the signal cable is disconnected. If you do not disconnect them, it may cause fire or electric shock.

UNPLUG THE MONITOR

If the monitor is not in use for a long period of time it is recommended that it is left unplugged to avoid accidents.

HOLD THE PLUG WHEN DISCONNECTING

To disconnect the power cable or signal cable, always pull it by the plug. Never pull on the cable itself as this may cause fire or electric shock.

DO NOT TOUCH THE PLUG WITH WET HANDS

Pulling or inserting the plug with wet hands may cause electric shock.

WHEN YOU INSTALL THE MONITOR ON YOUR COMPUTER

Be sure the computer is strong enough to hold the weight of the monitor, otherwise, you may damage your computer.

DO NOT PUT FLOPPY DISKS NEAR THE SPEAKERS

Magnetically recorded data, such as on a floppy disk, may become corrupted by the magnetic field produced by the speakers if the disks are placed on or near the speakers.

OTHERS

ERGONOMIC RECOMMENDATIONS

To eliminate eye fatigue, do not operate the monitor against a bright background or in a dark room. For optimal viewing comfort, the monitor should be just below eye level and 40-60 cm (16-24 inches) away from your eyes. When using the monitor over a prolonged time, a ten minute break every hour is recommended as looking at the screen continuously can cause eye strain.

SPECIAL NOTES ON LCD MONITORS

The following symptoms are normal with LCD monitors and do not indicate a problem.

NOTE

- When you first turn on the LCD monitor, the picture may not fit in the display area because of the type of computer that is used. In this case, adjust the picture position to the correct position.
- Due to the nature of the backlight, the screen may flicker during initial use. Turn off the Power Switch and then turn it on again to make sure the flicker disappears.
- You may find slightly uneven brightness on the screen depending on the desktop pattern you use.
- Due to the nature of the LCD screen, an afterimage of the previous screen may remain after switching the image, when the same image is displayed for hours. In this case, the screen is recovered slowly by changing the image or turning off the Power Switch for hours.
- Contact your dealer or iiyama service center for the backlight replacement when the screen is dark, flickering or not lighting up. Never attempt to replace it by yourself.

CUSTOMER SERVICE

NOTE

- The fluorescent light used in the LCD monitor may have to be periodically replaced. For the warranty coverage on this component, please check with local iiyama service center.
- If you have to return your unit for service and the original packaging has been discarded, please contact your dealer or iiyama service center for advice or replacement packaging.

CLEANING

WARNING

- If you drop any materials or liquids such as water into the monitor when cleaning, unplug the power cable immediately and contact your dealer or iiyama service center.

CAUTION

- For safety reasons, turn off the power switch and unplug the monitor before you clean it.

NOTE

- To protect the LCD panel, do not scratch or rub the screen with a hard object.
- Never use any of the following strong solvents. These will damage the cabinet and the LCD screen.

Thinner	Spray-type cleaner
Benzine	Wax
Abrasive cleaner	Acid or Alkaline solvent

- Touching the cabinet with any product made from rubber or plastic for a long time may cause degeneration or loss of paint on the cabinet.

CABINET

Stains can be removed with a cloth lightly moistened with a mild detergent solvent. Then wipe the cabinet with a soft dry cloth.

LCD SCREEN

Periodic cleaning with a soft dry cloth is recommended.

Don't use tissue paper etc. because these will damage the LCD screen.

BEFORE YOU OPERATE THE MONITOR

FEATURES

- ◆ 43cm (17.0") TFT Color LCD Monitor
- ◆ Supports Resolutions up to 1280 × 1024
- ◆ ProLite E1700S : High Contrast 600:1 / High Brightness 300cd/m² / Quick Response Time 5ms
- ◆ ProLite E1700SV : High Contrast 500:1 / High Brightness 300cd/m²
- ◆ Digital Character Smoothing
- ◆ Automatic Set-up
- ◆ Stereo Speakers
2 × 1W Stereo Speakers
- ◆ Plug & Play VESA DDC2B Compliant
Windows® 95/98/2000/Me/XP Compliant
- ◆ Power Management (ENERGY STAR® VESA DPMS Compliant)
- ◆ Ergonomic Design: TCO '03 and MPR 3 Approved
- ◆ Digital Input (DVI-D) for Clear Display : ProLite E1700S
- ◆ VESA Mounting Standard (100mm×100mm) Compliant

CHEKING THE CONTENTS OF THE PACKAGE

The following accessories are included in your package. Check to see if they are enclosed with the monitor. If anything is missing or damaged, please contact your local iiyama dealer or regional iiyama office.

- | | |
|----------------|---|
| ■ Power Cable* | ■ D-Sub Signal Cable (For ProLite E1700S) |
| ■ Audio Cable | ■ User Manual |

CAUTION

* The rating of the Power Cable enclosed in 120V area is 10A/125V. If you are using a power supply higher than this rating, then a power cable with a rating of 10A/250V must be used. However, all guarantees and warranties are void for any problems or damage caused by a power cable not supplied by iiyama.

HOW TO USE THE STAND

The monitor is the design that a stand rotate. Be sure to rotate the stand before operating the monitor, and rotate the stand upward before you re-box the monitor.

CAUTION

- Install the Stand on a stable surface. The monitor may cause injury or damage if it falls or is dropped.
- Do not give a strong impact to the monitor. It may cause damage.
- Unplug the monitor before installation to avoid electric shock or damage.

1. Lay the monitor flat on a table with front face down (see Fig 1). Put a piece of soft cloth on the table beforehand to prevent the monitor from being scratched.
2. Unpack the stand and mount it onto the monitor base with aligning it to the hook (see Fig 2).
3. Slide the stand upward until it makes a click sound, indicating it is fixed (see Fig 3).
4. Stand the monitor up (see Fig 4).



(Fig 1)



(Fig 2)



(Fig 3)



(Fig 4)

CONTROLS AND CONNECTORS

ENGLISH

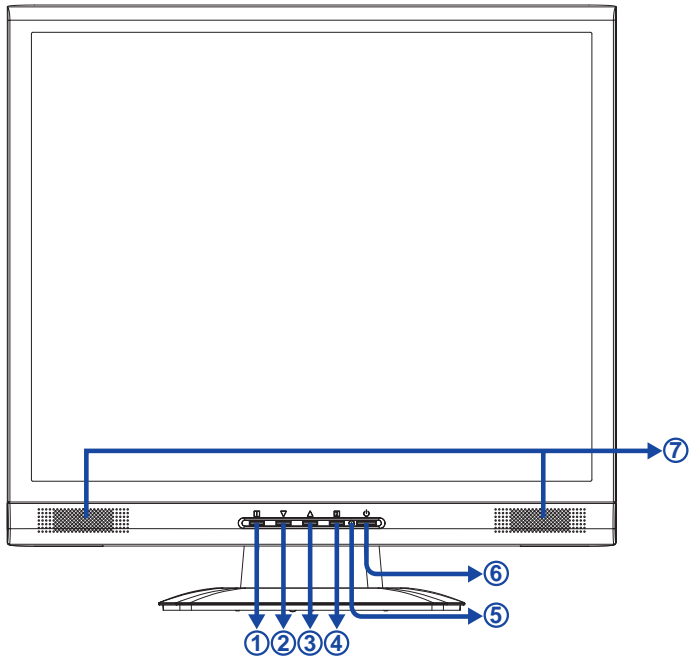

<Front>

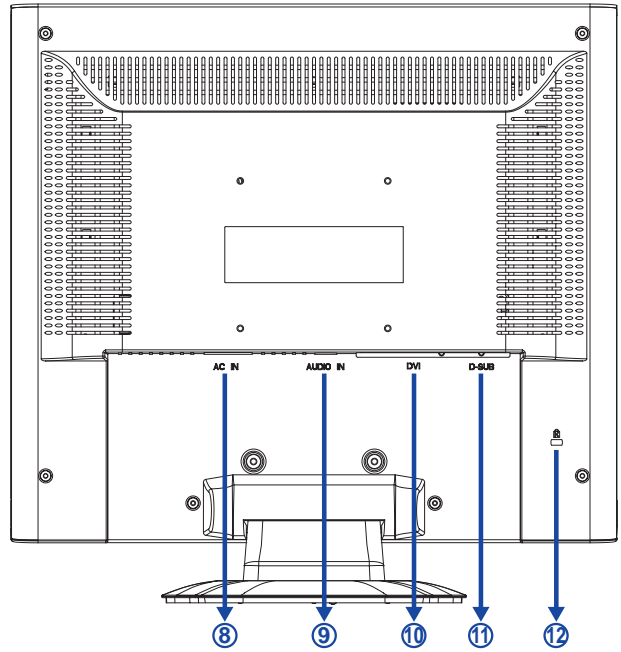

<Back>

- A Menu Button (1)
- B Scroll Down / Brightness Button (▼)
- C Scroll Up / Contrast Button (▲)
- D Select / Auto Button (2)
- E Power Indicator

NOTE Green: Normal operation
Orange: Power Management

The monitor enters into power management mode which reduces the power consumption to less than 2W when receiving no horizontal and/or vertical sync signal.

- F Power Switch (⏻)
- G Speakers
- H AC Connector (AC IN)
- I Audio Connector
- J DVI-D 24pin Connector (DVI)

NOTE Available for ProLite E1700S only.

- K D-SUB mini 15pin Connector (D-SUB) : ProLite E1700S
Signal Cable for D-SUB Connection (Fixed) : ProLite E1700SV
- L Keyhole for Security Lock

NOTE You can fasten a security lock and cable to prevent the monitor from being removed without your permission.

CONNECTING YOUR MONITOR

- A Ensure that both the computer and the monitor are switched off.
- B Connect the computer to the monitor with the signal cable.(See page 22 for CONNECTOR PIN ASSIGNMENT.)
- C Connect the monitor to the audio equipment with the Audio Cable for computer when using the audio features.
- D Connect the Power Cable to the monitor first and then to the power supply.

- NOTE**
- The signal cables used for connecting the computer and monitor may vary with the type of computer used. An incorrect connection may cause serious damage to both the monitor and the computer. The cable supplied with the monitor is for a standard 15 pin D-Sub connector. If a special cable is required please contact your local iiyama dealer or regional iiyama office.
 - For connection to Macintosh computers, contact your local iiyama dealer or regional iiyama office for a suitable adaptor.
 - Make sure you tighten the finger screws at each end of the signal cable.

[Example of Connection : ProLite E1700S]

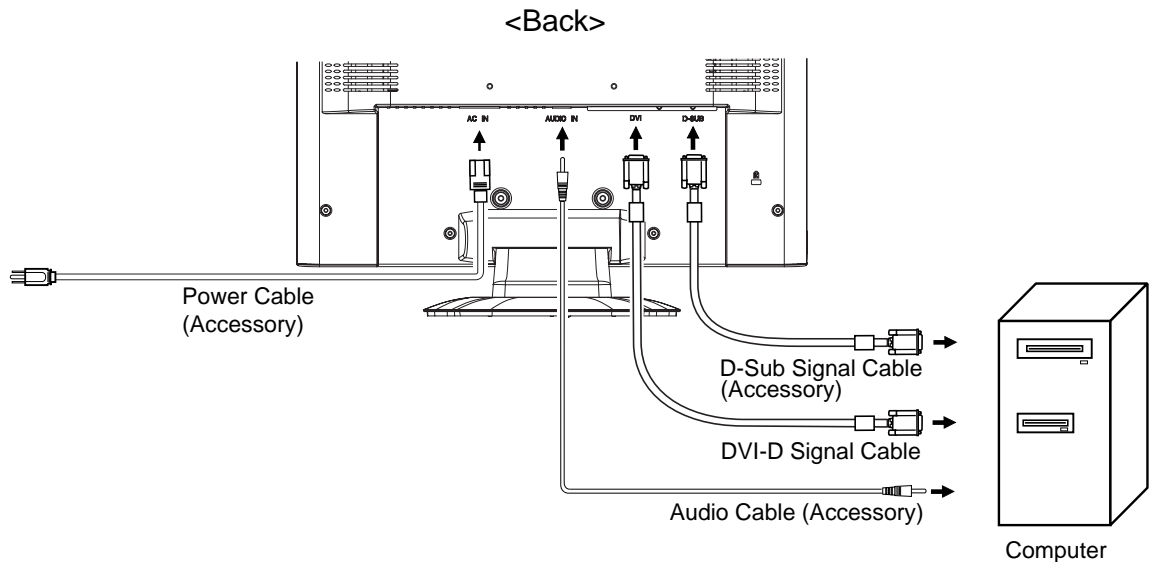

[Example of Connection : ProLite E1700SV]

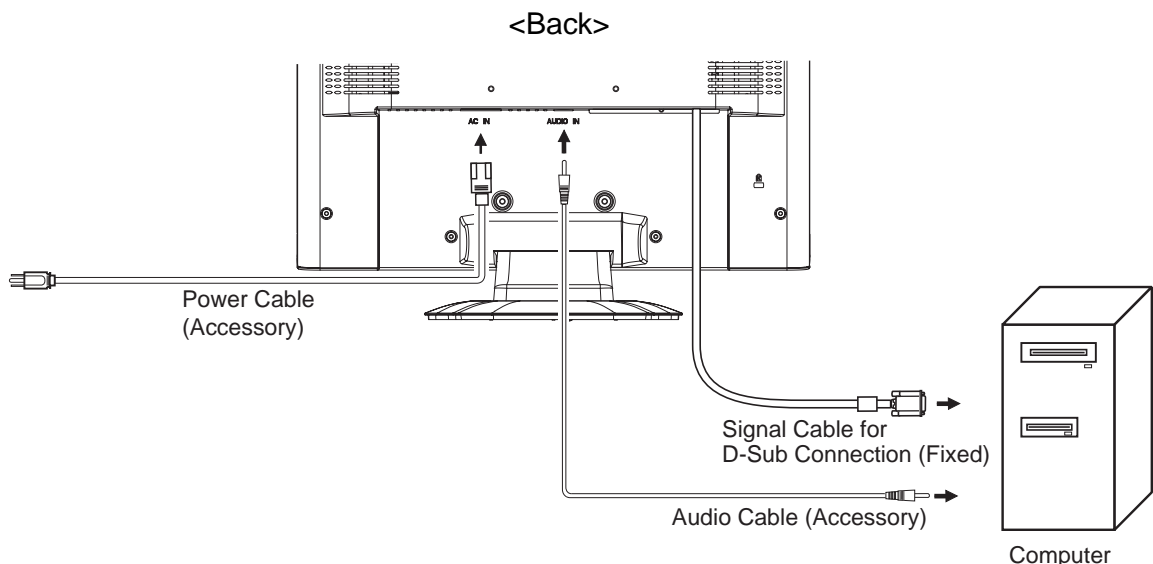

COMPUTER SETTING

■ Signal Timing

Change to the desired signal timing listed on page 21: COMPLIANT TIMING.

■ Windows 95/98/2000/Me/XP Plug & Play

The iiyama LCD monitor complies with DDC2B of VESA standard. The Plug & Play function runs on Windows 95/98/2000/Me/XP by connecting the monitor to DDC2B compliant computer with the Signal Cable supplied.

For installation on Windows 95/98/2000/Me/XP: The monitor Information File for iiyama monitors may be necessary for your computer and obtained via the Internet, using the address:

<http://www.iiyama.com>

NOTE

- For additional information on how to download the driver for your touch screen monitor, please access the internet site noted above.
- Monitor Drivers are not required in most cases for Macintosh or Unix operating systems. For further information, please contact your computer dealer first for advice.

ADJUSTING THE VIEWING ANGLE

- For optimal viewing it is recommended to look at the full face of the monitor.
- Hold the stand so that the monitor does not topple when you change the monitor's angle.
- You are able to adjust the monitor's angle up to 20 degrees backward. (The indication of 20 degrees: tilted LCD panel holds for a moment at this point. Tilt the panel gently; using too much force can easily cause the tilt angle to exceed 20 degrees.)
- In order to ensure a healthy and relaxed body position when using the monitor at visual display workstations, it is recommended that the adjusted tilt angle should not exceed 10 degrees. Adjust the monitor's angle to your own preference.

NOTE

- Do not touch the LCD screen when you change the angle. It may cause damage or break the LCD screen.
- Careful attention is required not to catch your fingers or hands when you change the angle.
- Do not tilt the post beyond 20 degrees except when repacking the monitor in its box. To do so may cause the monitor to fall over and break.

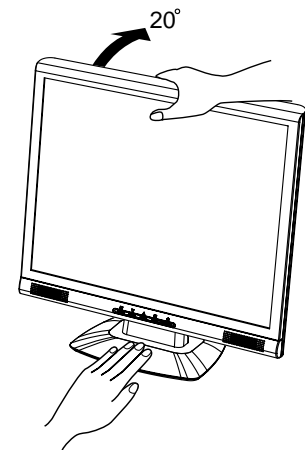
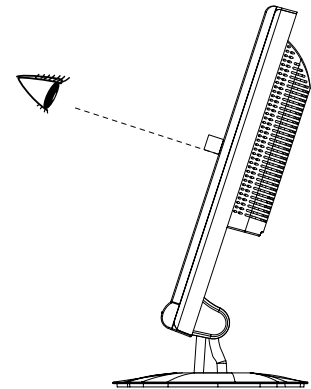

OPERATING THE MONITOR

To create the best picture, your iiyama LCD monitor has been preset at the factory with the COMPLIANT TIMING shown on page 21. You are also able to adjust the picture by following the button operation shown below. For more detailed adjustments, see page 13 for SCREEN ADJUSTMENTS.

- (** Press the Menu Button to start the On Screen Display feature. There are additional Menu items which can be switched by using the ▲/▼ Buttons.

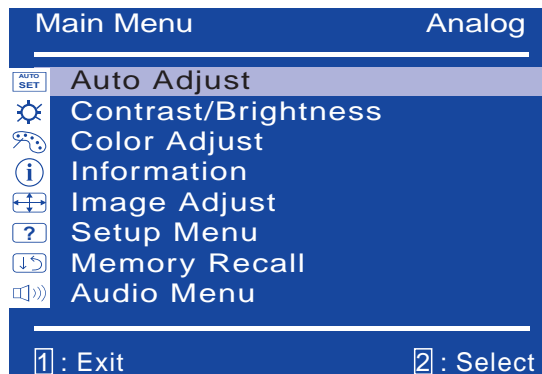

- B** Select the Menu item which contains the adjustment icon relating to the adjustment you want to make. Press the Select Button. Then, use the ▲/▼ Buttons to highlight the desired adjustment icon.
- C** Press the Select Button again. Use the ▲/▼ Buttons to make the appropriate adjustment or setting.

For example, to correct for vertical position, select Menu item of Image Adjust and then press the Select Button. Then, select  (H. / V.Position) by using the ▲/▼ Buttons.

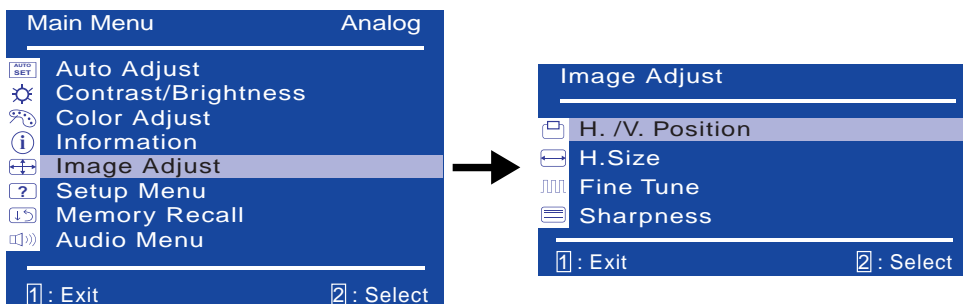

An adjustment page appears after you press the Select Button. Press the Select Button again. Then, use the ▲/▼ Buttons to change the vertical position settings. The vertical position of the overall display should be changing accordingly while you are doing this.

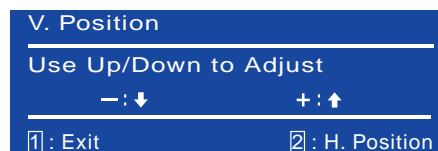

NOTE

- When button operations are aborted during adjustment, On-Screen Display disappears when the time set for the OSD Time Out has passed. Also, press the Menu button to quickly turn off the On-Screen Display.
- Any changes are automatically saved in the memory when the On Screen Display disappears. Turning off the power should be avoided while using the Menu.
- Adjustments for H. / V. Position, H.Size and Fine Tune are saved for each signal timing. Except for these adjustments, all other adjustments have only one setting which applies to all signal timings.

ADJUSTMENT MENU CONTENTS









Auto Adjust 		Auto Adjust	
Adjustment Item		Problem / Option	Button to Press
Auto Adjust *	Direct	Adjust H. / V. Position, H.Size and Fine Tune automatically.	
<div style="border: 1px solid black; padding: 2px; display: inline-block;">Only Analog Input</div>			
NOTE The screen becomes dark for approximately five seconds during the adjustment.			

* For best results, use the Auto Adjust in conjunction with the adjustment pattern. See page 13 for SCREENADJUSTMENTS.

Direct

You can skip the Menu items and display an adjustment scale directly by using the following button operations.

- Auto Adjust: Press the Auto Button when the Menu is not displayed.

Contrast/ Brightness 		Contrast/Brightness	
Adjustment Item		Problem / Option	Button to Press
Contrast	Direct	Too dull Too intense	   
Brightness *	Direct	Too dark Too bright	   

* Adjust the Brightness when you are using the monitor in a dark room and feel the screen is too bright.

NOTE







Contrast and Brightness are switched as follows by pressing the Select Button successively.

→ Contrast → Brightness →

Direct

You can skip the Menu items and display an adjustment scale directly by using the following button operations.

- Contrast: Press the Contrast Button when the Menu is not displayed.
- Brightness: Press the Brightness Button when the Menu is not displayed.

Color Adjust 		Color Adjust	
Adjustment Item	Problem / Option	Button to Press	
Cool	Bluish white (9300K)		
Normal	Reddish white (6500K)		
Warm	Greenish white (5400K)		
User Color	 2	R (Red)	Too weak  
		G (Green)	
		B (Blue)	Too strong  

Information  Information

Information































H.Frequency: 79.99 kHz
V.Frequency: 75.03 Hz
Pixel Clock: 135.04 MHz
Resolution: 1280 x 1024
Model Number: PLE1700S
Serial No: 0565760001001

 : Exit

Displays information regarding the current input signal coming from the graphic card in your computer.

NOTE









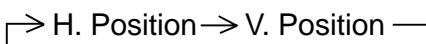







See your graphic card user guide for more information about changing the resolution and refresh

Image Adjust 		Image Adjust	
Adjustment Item	Problem / Option	Button to Press	
 H. / V. Position <div style="border: 1px solid black; padding: 2px; display: inline-block;">Only Analog Input</div>	 Too far to the left  Too far to the right	   	
	 Too low  Too high	   	
 H.Size <div style="border: 1px solid black; padding: 2px; display: inline-block;">Only Analog Input</div>	 Too narrow  Too wide	   	
 Fine Tune <div style="border: 1px solid black; padding: 2px; display: inline-block;">Only Analog Input</div>	To correct flickering text or lines	   	
 Sharpness	Adjust the picture quality at resolutions of less 1280 x 1024. You can change the picture quality (4 steps).	   	

NOTE







H. Position and V. Position are switched as follows by pressing the Select Button successively.



Setup Menu		Setup Menu		
Adjustment Item	Problem / Option		Button to Press	
 Language Select	English	English	Suomi	Finnish
	Français	French	日本語	Japanese
	Deutsch	German	中文繁體	Traditional Chinese
	Español	Spanish	中文简体	Simplified Chinese
	Italiano	Italian		
 Resolution Notice	Disable	The massage is turned off.		
	Enable	The message of "For best picture quality change resolution to 1280x1024" appears on the screen every 30 seconds when displaying less than 1280x1024.		
 OSD Position	H.	OSD is too far to the left		
		OSD is too far to the right		
	V.	OSD is too low		
		OSD is too high		
 OSD Time Out	You can set the OSD display duration time between 5 and 60 seconds.			  
 Input Select*	Analog	Select the Analog input.		
	Digital	Select the Digital input.		
NOTE	<ul style="list-style-type: none"> Analog and Digital are switched as follows by pressing the Select Button successively. <div style="border: 1px solid black; padding: 2px; display: inline-block;"> ➔ Analog ➔ Digital ➔ </div> When only one of the two signal inputs is connected to the signal source, the one connected is automatically selected. Input Select function is not available if there is no signal input from the selected connector or during the power management mode. 			

* Availavle for ProLite E1700S only.

Memory Recall		Memory Recall	
Adjustment Item	Problem / Option		Button to Press
Memory Recall	Factory-preset data is restored.		

Audio Menu		Audio Menu	
Adjustment Item	Problem / Option		Button to Press
 Volume	Too soft		 
	Too loud		 
 Mute	off	Return the sound volume to the previous level.	
	on	Turn off the sound temporarily.	
NOTE	<ul style="list-style-type: none"> Mute off and on are switched as follows by pressing the Select Button successively. <div style="border: 1px solid black; padding: 2px; display: inline-block;"> ➔ Mute off ➔ Mute on ➔ </div>  is displayed while Mute is active. 		

SCREEN ADJUSTMENTS

Adjust the image by following the procedure below to get the desired picture when selecting Analog input.

- The screen adjustments described in this manual are designed to set image position and minimize flicker or blur for the particular computer in use.
- The monitor is designed to provide the best performance at resolution of 1280 × 1024, but can not provide the best at resolutions of less than 1280 × 1024 because the picture is automatically stretched to fit the full screen. It is recommended to operate at resolution of 1280 × 1024 in normal use.
- Displayed text or lines will be blurred or irregular in thickness when the picture is stretched due to the screen enlargement process.
- It is preferable to adjust the image position and frequency with the monitor controls, rather than the computer software or utilities.
- Perform adjustments after a warm-up period of at least thirty minutes.
- Additional adjustments may be required after the Auto Adjust depending on the resolution or signal timing.
- The Auto Adjust may not work correctly when displaying the picture other than the screen adjustment pattern. In this case, manual adjustments are required.

There are two ways to adjust the screen. One way is automatic adjustment for Position, H.Size and Fine Tune. The other way is performing each adjustment manually.

Perform the Auto Adjust first when the monitor is connected to a new computer, or resolution is changed. If the screen has a flicker or blur, or the picture does not fit in the display area after performing the Auto Adjust, manual adjustments are required. Both adjustments should be made by using the screen adjustment pattern (Test.bmp) obtained via the Iiyama web site (<http://www.iiyama.com>).

Adjust the image by following the procedure below to get the desired picture.
This manual explains adjustment under Windows 95/98/2000/Me/XP.

A Display the picture at the optimum resolution.

B Enter the Test.bmp (screen adjustment pattern) to wallpaper.

NOTE

- Consult the appropriate documentation for doing this.
- Test.bmp is made at resolution of 1280 × 1024. Set the display position to center in the wallpaper setting dialogue box. If you use Microsoft® PLUS! 95/98 cancel the setting of “Stretch desktop wallpaper to fit the screen”.

[Adjustment pattern]

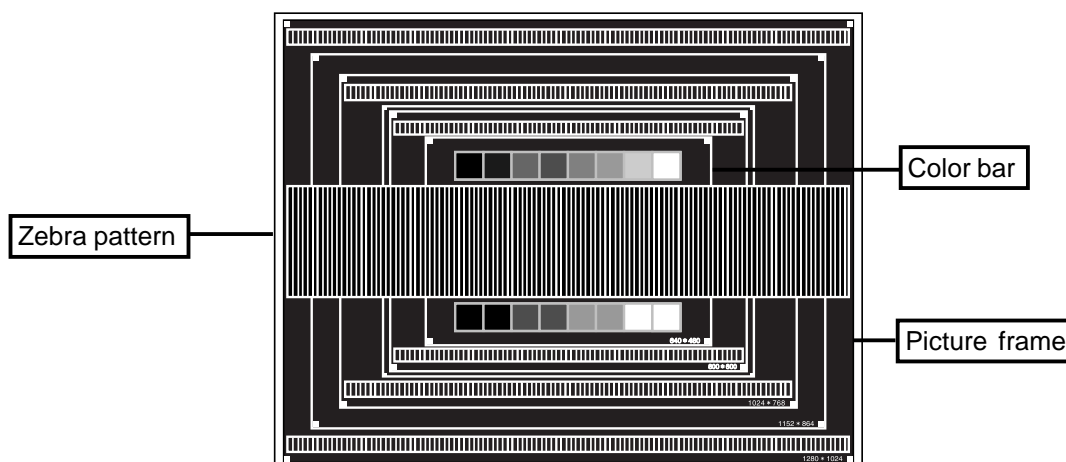

- C Press the Auto Button. (Auto Adjust)
- D Adjust the image manually by following procedure below when the screen has a flicker or blur, or the picture does not fit in the display area after performing the Auto Adjust.
- E Adjust the V.Position so that the top and bottom of the picture frame will fit to the display area.

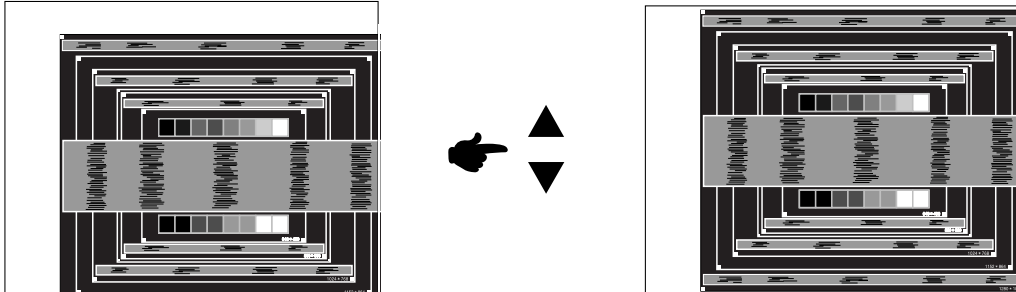

- F 1) Adjust the H.Position so that the left side of the picture frame will move to the left edge of the display area.

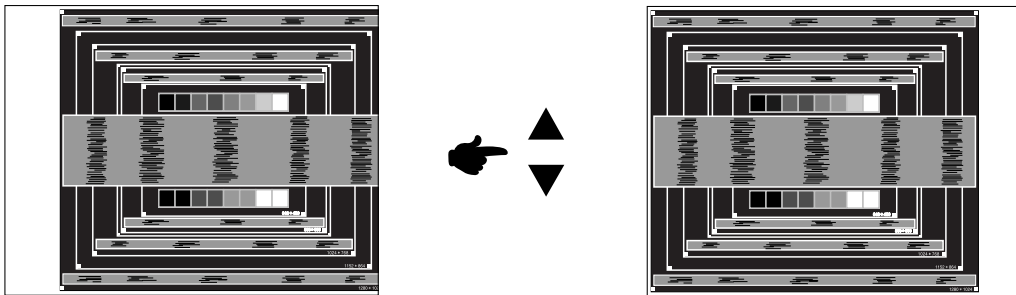

- 2) Stretch the right side of the picture frame to the right edge of the display area by adjusting the H.Size.

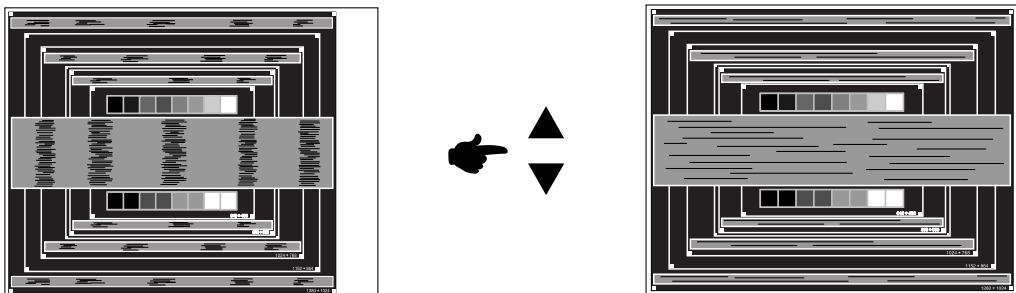
**NOTE**

- When the left side of the picture frame moves apart from the left edge of the display area during the H.Size adjustment, adjust steps 1) and 2).
- Another way to make the H.Size adjustment is to correct the vertical wavy lines in the zebra pattern.
- The picture may flicker during the H.Size, H.Position and V.Position adjustment.
- In case the picture frame is bigger or smaller than the data display area after the H.Size adjustment, repeat steps from C.

- G Adjust the Fine Tune to correct horizontal wavy noise, flicker or blur in the zebra pattern.**

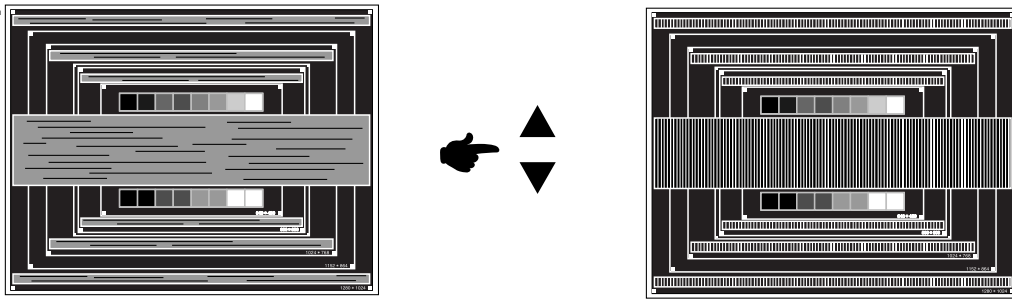

NOTE

- In case the strong flicker or blurs remain on a part of the screen, repeat steps **F** and **G** because the H.Size may not be adjusted correctly. If the flicker or blurs still remain, set the refresh rate of computer to low (60Hz) and repeat steps from **C** again.
- Adjust the H.Position after the Fine Tune adjustment if the horizontal position moves during the adjustment.

- H Adjust the Brightness and Color Adjust to get the desired picture after you complete the H.Size and Fine Tune adjustments.
Put back your favorite wallpaper.**

POWER MANAGEMENT FEATURE

The power management feature of this product complies with power saving requirement of ENERGY STAR® and VESA DPMS. When activated, it automatically reduces unnecessary power consumption of the monitor when your computer is not in use.

To use the feature, the monitor needs to be connected to a VESA DPMS compliant computer. There is a power management step the monitor takes as described below. The power management function, including any timer settings is configured by the operating system. Check your operating system manual for information on how this can be configured.

■ Power Management Mode

When the H-sync signal / V-sync signal / H and V sync signals from the computer are off, the monitor enters into Power Management Mode which reduces the power consumption to less than 2W. The screen becomes dark, and the power indicator turns to orange. From Power Management Mode, the image reappears in several seconds when either the keyboard or the mouse are touched again.

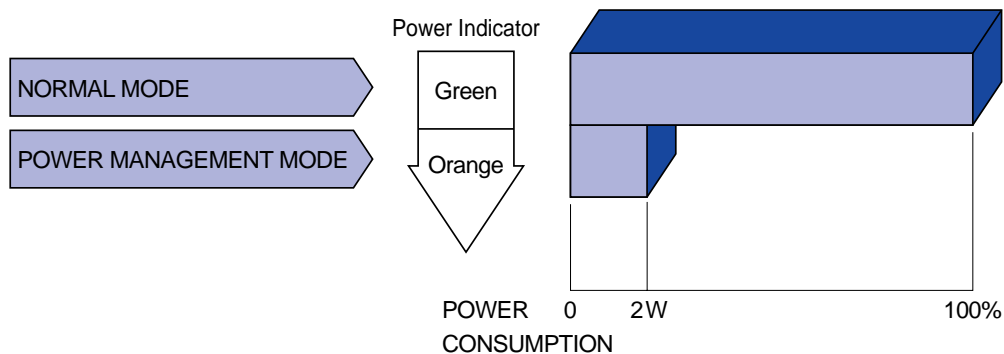

NOTE

- Even when using the power management mode, the monitor consumes electricity. Turn off the Power Switch whenever the monitor is not in use, during the night and weekends, to avoid unnecessary power consumption.
- It is possible that the video signal from the computer may be on while the H or V sync signal is missing. In this instance, the POWER MANAGEMENT feature may not work properly.

TROUBLE SHOOTING

If the monitor fails to operate correctly, please follow the steps below for a possible solution.

1. Perform the adjustments described in OPERATING THE MONITOR, depending on the problem you have. If the monitor does not get a picture, skip to 2.
2. Consult the following items if you cannot find an appropriate adjustment item in OPERATING THE MONITOR or if the problem persists.
3. If you are experiencing a problem which is not described below or you cannot correct the problem, discontinue using the monitor and contact your dealer or iiyama service center for further assistance.

Problem	Check
A The picture does not appear. (Power indicator does not light up.) (Power indicator is green.) (Power indicator is orange.)	<input type="checkbox"/> The Power Cable is firmly seated in the socket. <input type="checkbox"/> The Power Switch is turned ON. <input type="checkbox"/> The AC socket is live. Please check with another piece of equipment. <input type="checkbox"/> If the blank screen saver is in active mode, touch the keyboard or the mouse. <input type="checkbox"/> Increase the Contrast and/or Brightness. <input type="checkbox"/> The computer is ON. <input type="checkbox"/> The Signal Cable is properly connected. <input type="checkbox"/> The signal timing of the computer is within the specification of the monitor. <input type="checkbox"/> If the monitor is in power management mode, touch the keyboard or the mouse. <input type="checkbox"/> The computer is ON. <input type="checkbox"/> The Signal Cable is properly connected. <input type="checkbox"/> The signal timing of the computer is within the specification of the monitor.
B The screen is not synchronized.	<input type="checkbox"/> The Signal Cable is properly connected. <input type="checkbox"/> The signal timing of the computer is within the specification of the monitor. <input type="checkbox"/> The video output level of the computer is within the specification of the monitor.
C The screen position is not in the center.	<input type="checkbox"/> The signal timing of the computer is within the specification of the monitor.
D The screen is too bright or too dark.	<input type="checkbox"/> The video output level of the computer is within the specification of the monitor.
E The screen is shaking.	<input type="checkbox"/> The power voltage is within the specification of the monitor. <input type="checkbox"/> The signal timing of the computer is within the specification of the monitor.

Problem	Check
F No sound.	<input type="checkbox"/> The audio equipment (computer etc.) is ON. <input type="checkbox"/> The Audio Cable is properly connected. <input type="checkbox"/> The Volume is turned up. <input type="checkbox"/> The Mute is OFF. <input type="checkbox"/> The audio output level of the audio equipment is within the specification of the monitor.
G The sound is too loud or too quiet.	<input type="checkbox"/> The audio output level of the audio equipment is within the specification of the monitor.
H A strange noise is heard.	<input type="checkbox"/> The Audio Cable is properly connected.

APPENDIX

SPECIFICATIONS

Model		ProLite E1700S
LCD Panel	Driving system	a-Si TFT Active Matrix
	Size	Diagonal: 43cm / 17.0"
	Pixel pitch	0.264mm H x 0.264mm V
	Brightness	300cd/m ² (Typical)
	Contrast ratio	600 : 1 (Typical)
	Viewable angle	Right / Left : 70 degrees each, Up:67 degrees, Down: 63 degrees (Typical)
	Response time	5ms (Black, white, black)
Display Colors		Approx.16.2M (6bit+2bit dithering)
Sync Frequency		Horizontal: 30.0-80.0kHz, Vertical: 50-75Hz
Dot Clock		135MHz maximum
Maximum Resolution		1280 x 1024, 1.3 MegaPixels
Input Connector		D-Sub mini 15 pin DVI-D 24pin
Plug & Play		VESA DDC2B™
Input Sync Signal		Separate sync: TTL, Positive or Negative
Input Video Signal		Analog: 0.7Vp-p (Standard), 75Ω, Positive Digital: DVI(Digital Visual Interface standard Rev.1.0)compliance
Input Audio Connector		ø 3.5mm mini jack (Stereo)
Input Audio Signal		0.7Vrms maximum
Speakers		1W x 2 (Stereo speakers)
Maximum Screen Size		337.9mm W x 270.3mm H / 13.5" W x 10.8" H
Power Source		100-240VAC, 50/60Hz, 1.2A
Power Consumption		35W maximum, Power management mode: 2W maximum*
Dimensions / Net Weight		372 x 369x 176mm / 14.9 x14.8 x 7.0" (WxHxD), 3.8kg / 8.4lbs
Tilt Angle		20 degrees (Up: 0-20 degrees)
Environmental Considerations		Operating: Temperature 5 to 35°C / 41 to 95°F Humidity 10 to 80% (No condensation) Storage: Temperature -20 to 60°C / -4 to 140°F Humidity 5 to 85% (No condensation)
Approvals		TCO '03, CE, TÜV-GS / MPR 3 (prEN50279) / ISO 13406-2, FCC-B, UL/C-UL, VCCI-B, GOST-R

NOTE * Condition: Audio equipment is not connected.

Model		ProLite E1700SV
LCD Panel	Driving system	a-Si TFT Active Matrix
	Size	Diagonal: 43cm / 17.0"
	Pixel pitch	0.264mm H x 0.264mm V
	Brightness	300cd/m ² (Typical)
	Contrast ratio	500 : 1 (Typical)
	Viewable angle	Right / Left : 70 degrees each, Up:67 degrees, Down: 63 degrees (Typical)
	Response time	8ms (Black, white, black)
Display Colors		Approx.16.2M (6bit+2bit dithering)
Sync Frequency		Horizontal: 30.0-80.0kHz, Vertical: 50-75Hz
Dot Clock		135MHz maximum
Maximum Resolution		1280 x 1024, 1.3 MegaPixels
Input Connector		D-Sub mini 15 pin
Plug & Play		VESA DDC2B™
Input Sync Signal		Separate sync: TTL, Positive or Negative
Input Video Signal		Analog: 0.7Vp-p (Standard), 75Ω, Positive
Input Audio Connector		ø 3.5mm mini jack (Stereo)
Input Audio Signal		0.7Vrms maximum
Speakers		1W x 2 (Stereo speakers)
Maximum Screen Size		337.9mm W x 270.3mm H / 13.5" W x 10.8" H
Power Source		100-240VAC, 50/60Hz, 1.2A
Power Consumption		35W maximum, Power management mode: 2W maximum*
Dimensions / Net Weight		372 x 369x 176mm / 14.9 x14.8 x 7.0" (WxHxD), 3.8kg / 8.4lbs
Tilt Angle		20 degrees (Up: 0-20 degrees)
Environmental Considerations		Operating: Temperature 5 to 35°C / 41 to 95°F Humidity 10 to 80% (No condensation) Storage: Temperature -20 to 60°C / -4 to 140°F Humidity 5 to 85% (No condensation)
Approvals		TCO '03, CE, TÜV-GS / MPR 3 (prEN50279) / ISO 13406-2, FCC-B, UL/C-UL, VCCI-B, GOST-R

NOTE * Condition: Audio equipment is not connected.

DIMENSIONS

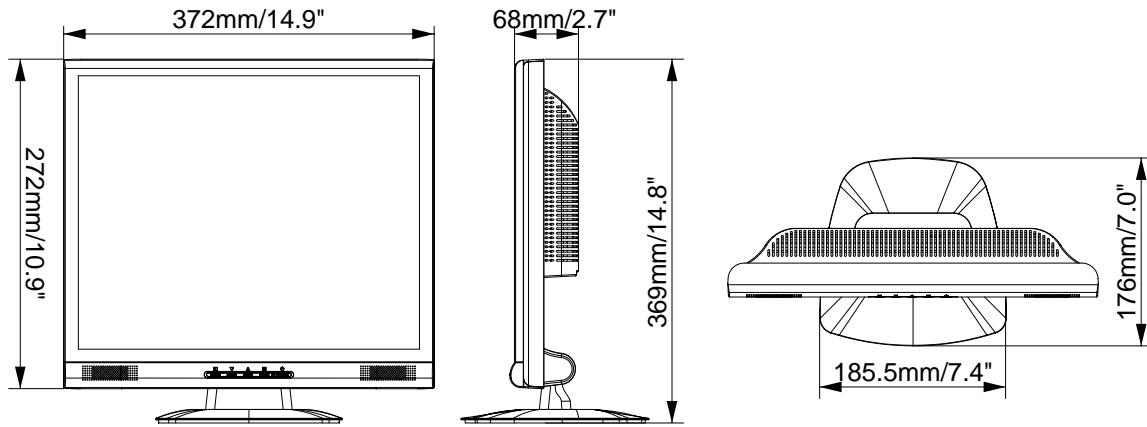

COMPLIANT TIMING

Video Mode		Horizontal Frequency	Vertical Frequency	Dot Clock	
VESA	VGA 640 × 480	31.468kHz	59.941Hz	25.175MHz	
		37.500kHz	74.997Hz	31.500MHz	
	SVGA 800 × 600	35.156kHz	56.249Hz	36.000MHz	
		37.878kHz	60.317Hz	40.000MHz	
		46.875kHz	75.001Hz	49.500MHz	
		48.076kHz	72.186Hz	50.000MHz	
	XGA 1024 × 768	48.362kHz	60.002Hz	65.000MHz	
		56.474kHz	70.067Hz	75.000MHz	
		60.024kHz	75.039Hz	78.750MHz	
	SXGA 1280 × 1024	63.979kHz	60.029Hz	108.000MHz	
79.974kHz		75.024Hz	135.000MHz		
VGA TEXT	720 × 400	31.468kHz	70.086Hz	28.322MHz	*
Macintosh	640 × 480	35.000kHz	66.667Hz	30.240MHz	*
	832 × 624	49.724kHz	74.532Hz	57.280MHz	*

NOTE

* DVI input is not compliant.

CONNECTOR PIN ASSIGNMENT

■ D-Sub mini 15pin Connector

[ProLite E1700S]

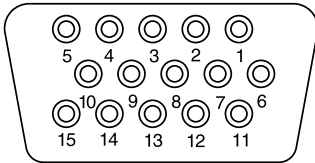

D-SUB

[ProLite E1700SV]

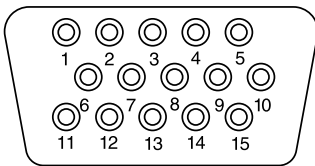

D-SUB

Pin	Input Signal	Pin	Input Signal
1	Red video	9	+5V
2	Green video	10	Ground
3	Blue video	11	NC
4	NC	12	Data line (SDA)*
5	Ground	13	H-Sync
6	Red video ground	14	V-Sync
7	Green video ground	15	Clock line (SCL)*
8	Blue video ground	* Compliant to VESA DDC.	

■ DVI-D 24pin Connector*



DVI-D

Pin	Input Signal	Pin	Input Signal
1	T.M.D.S Data 2-	13	
2	T.M.D.S Data 2+	14	+5V
3	T.M.D.S Data 2 Ground	15	Ground
4		16	Hot Plug Detect
5		17	T.M.D.S Data 0-
6	Clock line (SCL) *	18	T.M.D.S Data 0+
7	Data line (SDA) *	19	T.M.D.S Data 0 Ground
8	V-Sync	20	
9	T.M.D.S Data 1-	21	
10	T.M.D.S Data 1+	22	T.M.D.S Clock Ground
11	T.M.D.S Data 1 Ground	23	T.M.D.S Clock +
12		24	T.M.D.S Clock -

* Compliant to VESA DDC.

* Available for ProLite E1700S only.