

ADSL Modem Router Setup Manual

NETGEAR

NETGEAR, Inc.
4500 Great America Parkway
Santa Clara, CA 95054 USA

208-10026-01
2006-2

© 2006 by NETGEAR, Inc. All rights reserved.

Trademarks

NETGEAR is a trademark of Netgear, Inc. Microsoft, Windows, and Windows NT are registered trademarks of Microsoft Corporation. Other brand and product names are registered trademarks or trademarks of their respective holders.

Statement of Conditions

In the interest of improving internal design, operational function, and/or reliability, NETGEAR reserves the right to make changes to the products described in this document without notice.

NETGEAR does not assume any liability that may occur due to the use or application of the product(s) or circuit layout(s) described herein.

ADSL Modem Router Setup Manual

Chapter 1

Connecting the Router to the Internet

What's in the Box?	1-1
The Router's Front Panel	1-2
The Router's Rear Panel	1-3
What You Need Before You Begin	1-3
Internet Configuration Requirements	1-4
Two Setup Methods: 1) Smart Wizard Setup 2) Manual Setup	1-4
Smart Wizard Setup	1-4
Manual Setup	1-5
Understanding ADSL Microfilters	1-5
Computers Set to DHCP	1-6
Manually Setting Up Your ADSL Modem Router	1-6

Chapter 2

Troubleshooting

Basic Functioning	2-1
Power LED Not On	2-2
Test LED Never Turns On or Test LED Stays On	2-2
LAN or ADSL Internet Port LEDs Not On	2-3
Troubleshooting the Web Configuration Interface	2-3
Troubleshooting the ISP Connection	2-4
ADSL link	2-4
Obtaining an Internet IP Address	2-5
Troubleshooting PPPoE or PPPoA	2-6
Troubleshooting Internet Browsing	2-7
Troubleshooting a TCP/IP Network Using the Ping Utility	2-7
Testing the LAN Path to Your Router	2-7

Testing the Path from Your Computer to a Remote Device	2-8
Restoring the Default Configuration and Password	2-9
Using the Reset Button	2-9

Appendix A

Technical Specifications

Appendix B

Related Documents

Chapter 1

Connecting the Router to the Internet

This chapter describes how to set up the router on your Local Area Network (LAN) and connect to the Internet. It describes how to set up your ADSL modem router for Internet access and configure basic wireless connectivity.

What's in the Box?

The product package should contain the following items:

- ADSL Modem Router
- AC power adapter (varies by region)
- Category 5 (Cat 5) Ethernet cable
- Telephone cable with RJ-11 connector
- Microfilters (quantity and type vary by region)
- *Resource CD*, including:
 - The Smart Wizard Installation Assistant
 - This manual
- Warranty and Support Information cards

If any of the parts are incorrect, missing, or damaged, contact your NETGEAR dealer. Keep the carton, including the original packing materials, in case you need to return the product for repair.

The Router's Front Panel

The ADSL modem router front panel shown below contains status LEDs.

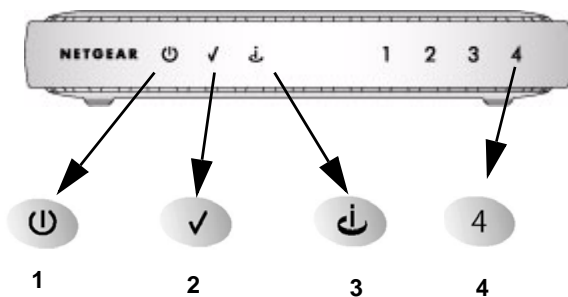

Figure 1-1

You can use the LEDs to verify various conditions. [Table 1-1](#) describes each LED.

Table 1-1. LED Descriptions

Label	Activity	Description
1. Power	On Off	Power is supplied to the router. Power is not supplied to the router.
2. Test	On Off	The system is initializing. The system is ready and running.
3. Internet	Blink -- Amber On -- Green Blink -- Green	Indicates ADSL training. The Internet port has detected a link with an attached device. Data is being transmitted or received by the Internet port.
4. LAN	On (Green) Blink (Green) On (Amber) Blink (Amber) Off	The Local port has detected a link with a 100 Mbps device. Data is being transmitted or received at 100 Mbps. The Local port has detected a link with a 10 Mbps device. Data is being transmitted or received at 10 Mbps. No link is detected on this port.

The Router's Rear Panel

The rear panel of the ADSL modem router contains port connections.

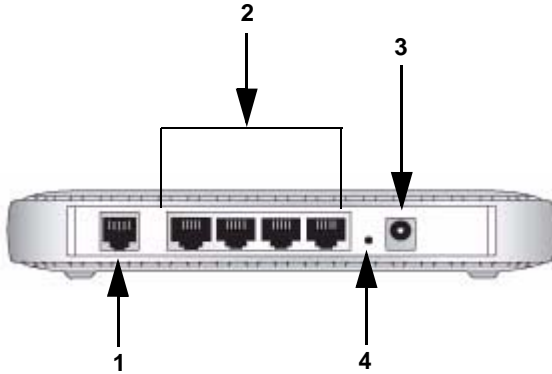

Figure 1-2

Viewed from left to right, the rear panel contains the following elements:

1. RJ-11 ADSL port for connecting the router to an ADSL line
2. Four Local Ethernet RJ-45 LAN ports for connecting the router to the local computers
3. AC power adapter outlet
4. Factory Default Reset push button

What You Need Before You Begin

You need to prepare the following before you can set up your router:

- Active Internet service provided by an ADSL account.
- The Internet Service Provider (ISP) configuration information for your ADSL account.
- ADSL microfilters as explained below.
- Your computers set to DHCP.

Internet Configuration Requirements

Depending on how your ISP set up your Internet account, you need one or more of these configuration parameters to connect your router to the Internet:

- Virtual Path Identifier (VPI)/Virtual Channel Identifier (VCI) parameters
- Multiplexing Method
- Host and Domain Names
- ISP Login Name and Password
- ISP Domain Name Server (DNS) Addresses
- Fixed or Static IP Address

Your ISP should have provided you with all the information needed to connect to the Internet. If you cannot locate this information, you can ask your ISP to provide it.

Two Setup Methods: 1) Smart Wizard Setup 2) Manual Setup

You have two methods available for setting up your ADSL modem router:

- **Smart Wizard Setup:** Use the Smart Wizard on the CD to assist you with setting up your ADSL modem router.
 - This option is the easiest. The Smart Wizard on the CD guides you through the setup process, automating many of the steps, and verifying that necessary conditions exist and that steps you perform have been successfully completed.
 - This option requires a PC running Microsoft Windows 98SE or higher.
- **Manual Setup:** Manually set up your ADSL modem router.
 - This option is best if you are replacing an existing ADSL modem router or are technically knowledgeable.
 - Use this option if you are using a computer that does not run Microsoft Windows.
 - The manual setup procedures are documented in this manual.

Use the setup option that best suites you.

Smart Wizard Setup

The Smart Wizard setup process should take about 20 minutes to complete.

1. Locate the ADSL settings information your Internet service provider gave you.
2. Insert the NETGEAR CD into a Windows PC.

The CD will automatically start and detect the language you are using on your PC.



Note: If the CD does not automatically start, browse the CD and double-click on Autorun.

3. Accept the language option or change to a different language.
4. Click Next to proceed.
5. Click Setup to start the Smart Wizard installation assistant. Follow the instructions on the screen.

Manual Setup

Use the topics and procedures below to manually set up your ADSL modem router.

Understanding ADSL Microfilters

ADSL technology uses the same wires as your telephone service. However, ADSL adds signals to the telephone lines which create noise in the telephone service. You must use ADSL microfilters to filter out these signals before they reach your telephone.



Note: If you purchased the ADSL modem router in a country where a microfilter is not included, you must acquire one.

ADSL Microfilter

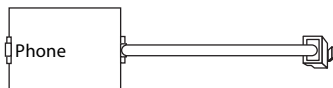

Figure 1-3

Each device such as a telephone, fax machine, answering machine, or caller ID display will require an ADSL microfilter.



Warning: Do not connect the ADSL modem router to the ADSL line through a microfilter unless the microfilter is a combination microfilter/splitter specifically designed for this purpose. Doing so will prevent block your connection to the Internet. If you have any doubts about this, connect the ADSL modem router directly to the ADSL line.

ADSL Microfilter with Built-In Splitter

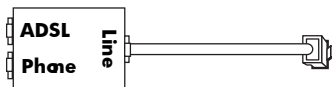

Figure 1-4

Use an ADSL microfilter with built-in splitter when there is a single wall outlet which must provide connectivity for both the ADSL modem router and telephone equipment.

Computers Set to DHCP

For the initial connection to your router, your computer has to be set to automatically get its TCP/IP configuration from the router via DHCP. This is usually the case. The NETGEAR Smart Wizard CD automatically takes care of this requirement. For manual setup, refer to the documentation that came with your computer.

Manually Setting Up Your ADSL Modem Router

There are four steps to setting up your ADSL modem router:

1. Install ADSL filters on the phone lines.
2. Connect the router to the ADSL line.
3. Log in to the router.
4. Connect to the Internet.

Follow the steps below to connect your router to your network. Before you begin, locate the ADSL configuration information from your Internet Service Provider (ISP).

1. Connect the ADSL filter.

	Note: If you purchased the DG834 in a country where an ADSL filter is not included, you must acquire one.
---	--

- a. You need to install an ADSL filter for every telephone that uses the same phone line as your ADSL modem router. Select the filter that came with your ADSL modem router.

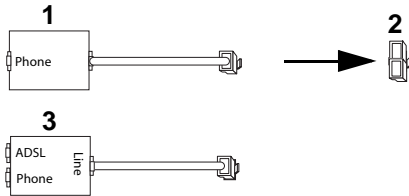

1. One-Line Filter: Use with a phone or fax machine.
2. Splitter: Use with a one-line filter to share an outlet with a phone and the ADSL modem router.
3. Two-Line Filter with Splitter: Use to share an outlet with a phone and the ADSL modem router.

Figure 1-5

- b. **Two-Line Filter Example.** Insert the two-line filter into the phone outlet and connect the phone to the phone line connector (A):

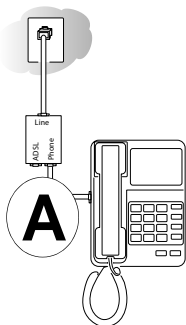

Figure 1-6



Note: To use a one-line filter with a separate splitter, insert the splitter into the phone outlet, connect the one-line filter to the splitter, and connect the phone to the filter.

2. Connect the ADSL modem router to the ADSL filter.
 - a. Using the included phone cable with RJ-11 jacks, connect the ADSL port (B) of the ADSL modem router to the ADSL port (C) of the two-line filter.

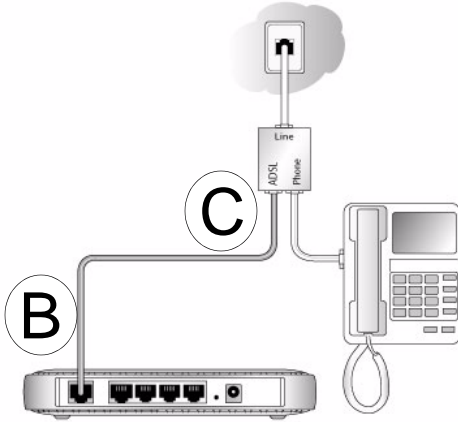

Figure 1-7



Warning: Improperly connecting a filter to your ADSL modem router will block your ADSL connection.

- b. Connect the Ethernet cable (**D**) from a ADSL modem router LAN port to the Ethernet adapter in your computer.

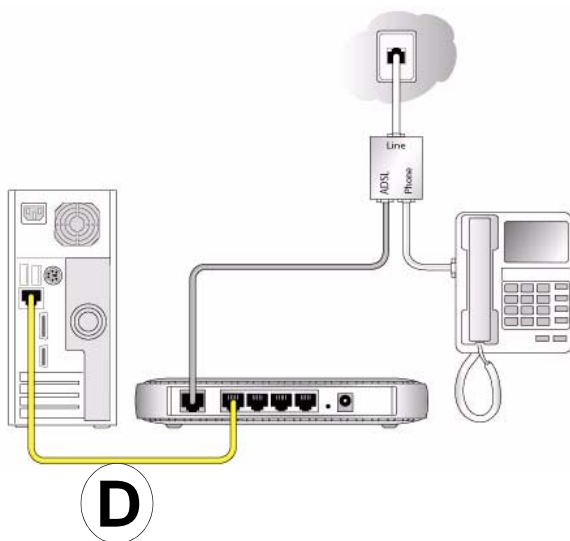

Figure 1-8

- c. Connect the power adapter to the router and plug it in to a power outlet. Verify the following:
 - ⏻ The power light is lit after turning on the router.
 - ✓ The test light comes on briefly, then goes off.
 - 📶 The ADSL light is green, indicating you are connected to the ADSL network.
- d. Now, turn on your computer. If software usually logs you in to your Internet connection, do not run that software. Cancel it if it starts automatically. Verify the following:
 - 4 The local lights are lit for any connected computers.

3. Log in to the ADSL modem router.



Note: Your computer needs to be configured for DHCP. For instructions on configuring for DHCP, please see the documentation that came with your computer or [“Preparing a Computer for Network Access”](#).

- a. Type `http://192.168.0.1` in the address field of a browser such as Internet Explorer or Netscape® Navigator.



Figure 1-9

This login window opens:



Figure 1-10

Enter **admin** for the user name and **password** for the password, both in lower case letters.

- b. After logging in, you will see the menu below.

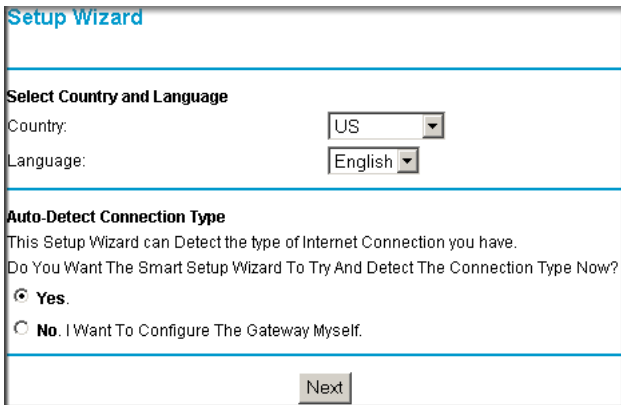

Figure 1-11

4. Connect to the Internet

You are now ready to configure your ADSL modem router to connect to the Internet. There are two ways you can configure your ADSL modem router to connect to the Internet:

- a. Let the ADSL modem router Setup Wizard auto-detect the type of Internet connection you have and configure it.
- b. Manually choose which type of Internet connection you have and configure it.

In either case, use the configuration parameters your ISP provided to assure that the configuration settings for your Internet connection are correct.

5. Test your Internet connection.

From the bottom of the Setup menu, click Test. If the NETGEAR Web site does not appear within one minute, refer to [Chapter 2, “Troubleshooting”](#).

Your ADSL modem router is now configured to provide Internet access for your network. Your ADSL modem router automatically connects to the Internet when one of your computers requires access. It is not necessary to run a dialer or login application such as Dial-Up Networking or Enternet to connect, log in, or disconnect. These functions are performed automatically by the ADSL modem router as needed.

To access the Internet from any computer connected to your ADSL modem router, launch a browser such as Microsoft Internet Explorer or Netscape Navigator. You should see the ADSL modem router’s Internet LED blink, indicating communication to the ISP. The browser should begin to display a Web page.

Chapter 2

Troubleshooting

This chapter gives information about troubleshooting your ADSL modem router. After each problem description, instructions are provided to help you diagnose and solve the problem. For the common problems listed, go to the section indicated.

- Is the router on?
Go to [“Basic Functioning” on page 2-1](#).
- Have I connected the router correctly?
Go to [“Basic Functioning” on page 2-1](#).
- I cannot access the router’s configuration with my browser.
Go to [“Troubleshooting the Web Configuration Interface” on page 2-3](#).
- I have configured the router but I can’t access the Internet.
Go to [“Troubleshooting the ISP Connection” on page 2-4](#).
- I cannot remember the router’s configuration password.
Go to [“Using the Reset Button” on page 2-9](#).
- I want to clear the configuration and start over again.
Go to [“Restoring the Default Configuration and Password” on page 2-9](#).

Basic Functioning

After you turn on power to the router, the following sequence of events should occur:

1. When power is first applied, verify that the Power LED is on (see [“The Router’s Front Panel” on page 1-2](#) for an illustration and explanation of the LEDs).
2. Verify that the Test LED lights within a few seconds, indicating that the self-test procedure is running.
3. After approximately 10 seconds, verify that:
 - a. The Test LED is not lit.

- b. The LAN port LEDs are lit for any local ports that are connected.
- c. The ADSL Internet port LED is lit.

If a port's LED is lit, a link has been established to the connected device. If a LAN port is connected to a 100 Mbps device, verify that the port's LED is green. If the port is 10 Mbps, the LED will be amber.

If any of these conditions does not occur, refer to the appropriate following section.

Power LED Not On

If the Power and other LEDs are off when your router is turned on:

- Make sure that the power cord is properly connected to your router and that the power supply adapter is properly connected to a functioning power outlet.
- Check that you are using the power adapter supplied by NETGEAR for this product.

If the error persists, you have a hardware problem and should contact technical support.

Test LED Never Turns On or Test LED Stays On

When the router is turned on, the Test LED turns on for about 10 seconds and then turns off. If the Test LED does not turn on, or if it stays on, there is a fault within the router.

If you experience problems with the Test LED:

- Cycle the power to see if the router recovers and the LED blinks for the correct amount of time.

If all LEDs including the Test LED are still on one minute after power up:

- Cycle the power to see if the router recovers.
- Clear the router's configuration to factory defaults. This will set the router's IP address to 192.168.0.1. This procedure is explained in ["Using the Reset Button" on page 2-9](#).

If the error persists, you might have a hardware problem and should contact technical support.

LAN or ADSL Internet Port LEDs Not On

If either the LAN LEDs or ADSL Internet LED do not light when the Ethernet connection is made, check the following:

- Make sure that the Ethernet cable connections are secure at the router and at the hub or workstation.
- Make sure that power is turned on to the connected hub or workstation.
- Be sure you are using the correct cable: when connecting the ADSL port, use the cable that was supplied with the ADSL modem router.

Troubleshooting the Web Configuration Interface

If you are unable to access the router's Web Configuration interface from a computer on your local network, check the following:

- If you are using an Ethernet-connected computer, check the Ethernet connection between the computer and the router as described in the previous section.
- Make sure your computer's IP address is on the same subnet as the router. If you are using the recommended addressing scheme, your computer's address should be in the range of 192.168.0.2 to 192.168.0.254. Refer to [“Preparing a Computer for Network Access”](#) to find your computer's IP address.



Note: If your computer's IP address is shown as 169.254.x.x:

Recent versions of Windows and MacOS will generate and assign an IP address if the computer cannot reach a DHCP server. These auto-generated addresses are in the range of 169.254.x.x. If your IP address is in this range, check the connection from the computer to the router and reboot your computer.

- If your router's IP address was changed and you do not know the current IP address, clear the router's configuration to factory defaults. This will set the router's IP address to 192.168.0.1. This procedure is explained in [“Using the Reset Button”](#) on page 2-9.
- Make sure your browser has Java, JavaScript, or ActiveX enabled. If you are using Internet Explorer, click Refresh to be sure the Java applet is loaded.
- Try quitting the browser and launching it again.

- Make sure you are using the correct login information. The factory default login name is **admin** and the password is **password**. Make sure that CAPS LOCK is off when entering this information.

If the router does not save changes you have made in the Web Configuration Interface, check the following:

- When entering configuration settings, be sure to click the **Apply** button before moving to another menu or tab, or your changes are lost.
- Click the Refresh or Reload button in the Web browser. The changes may have occurred, but the Web browser may be caching the old configuration.

Troubleshooting the ISP Connection

If your router is unable to access the Internet, you should check the ADSL connection, then the Internet TCP/IP connection.

ADSL link

If your router is unable to access the Internet, you should first determine whether you have an ADSL link with the service provider. The state of this connection is indicated with the Internet LED.

ADSL Internet LED Green or Blinking Green

If your ADSL Internet LED is green or blinking green, then you have a good ADSL connection. You can be confident that the service provider has connected your line correctly and that your wiring is correct.

ADSL Internet LED Blinking Yellow

If your ADSL Internet LED is blinking yellow, then your ADSL modem router is attempting to make an ADSL connection with the service provider. The LED should turn green within several minutes.

If the Internet LED does not turn green, disconnect all telephones on the line. If this solves the problem, reconnect the telephones one at a time, being careful to use a microfilter on each telephone. If the microfilters are connected correctly, you should be able to connect all your telephones.

If disconnecting telephones does not result in a green ADSL Internet LED, there may be a problem with your wiring. If the telephone company has tested the ADSL signal at your Network Interface Device (NID), then you may have poor quality wiring in your house.

ADSL Internet LED Off

If the ADSL Internet LED is off, disconnect all telephones on the line. If this solves the problem, reconnect the telephones one at a time, being careful to use a microfilter on each telephone. If the microfilters are connected correctly, you should be able to connect all your telephones.

If disconnecting telephones does not result in a green ADSL Internet LED the problem may be one of the following:

- Check that the telephone company has made the connection to your line and tested it.
- Verify that you are connected to the correct telephone line. If you have more than one phone line, be sure that you are connected to the line with the ADSL service. It may be necessary to use a swapper if you ADSL signal is on pins 1 and 4 of the RJ-11 jack. The ADSL Modem Router uses pins 2 and 3.

Obtaining an Internet IP Address

If your ADSL modem router is unable to access the internet, and your Internet LED is green or blinking green, you should determine whether the ADSL modem router is able to obtain a Internet IP address from the ISP. Unless you have been assigned a static IP address, your ADSL modem router must request an IP address from the ISP. You can determine whether the request was successful using the browser interface.

To check the Internet IP address from the browser interface:

1. Launch your browser and select an external site such as <http://www.netgear.com>.
2. Access the Main Menu of the ADSL modem router's configuration at <http://192.168.0.1>.
3. Under the Maintenance heading check that an IP address is shown for the Internet Port. If 0.0.0.0 is shown, your ADSL modem router has not obtained an IP address from your ISP.

If your router is unable to obtain an IP address from the ISP, the problem may be one of the following:

- Your ISP may require a Multiplexing Method or Virtual Path Identifier/Virtual Channel Identifier parameter.

Verify with your ISP the Multiplexing Method and parameter value, and update the router's ADSL Settings accordingly.

- Your ISP may require a login program.

Ask your ISP whether they require PPP over Ethernet (PPPoE) or PPP over ATM (PPPOA) login.

- If you have selected a login program, you may have incorrectly set the Service Name, User Name and Password. See "[Troubleshooting PPPoE or PPPoA](#)", below.
- Your ISP may check for your computer's host name.
Assign the computer Host Name of your ISP account to the ADSL modem router in the browser-based Setup Wizard.
- Your ISP only allows one Ethernet MAC address to connect to Internet, and may check for your computer's MAC address. In this case:

Inform your ISP that you have bought a new network device, and ask them to use the router's MAC address.

OR

Configure your router to spoof your computer's MAC address. This can be done in the Basic Settings menu. Refer to the online help in the ADSL modem router main menu.

Troubleshooting PPPoE or PPPoA

The PPPoA or PPPoA connection can be debugged as follows:

1. Access the Main Menu of the router at <http://192.168.0.1>.
2. Under the Maintenance heading, select the Router Status link.
3. Click the Connection Status button.
4. If all of the steps indicate "OK" then your PPPoE or PPPoA connection is up and working.
5. If any of the steps indicates "Failed", you can attempt to reconnect by clicking "Connect". The ADSL modem router will continue to attempt to connect indefinitely.

If you cannot connect after several minutes, you may be using an incorrect Service Name, User Name or Password. There also may be a provisioning problem with your ISP.



Note: Unless you connect manually, the ADSL modem router will not authenticate using PPPoE or PPPoA until data is transmitted to the network.

Troubleshooting Internet Browsing

If your ADSL modem router can obtain an IP address but your computer is unable to load any Web pages from the Internet:

- Your computer may not recognize any DNS server addresses.

A DNS server is a host on the Internet that translates Internet names (such as www addresses) to numeric IP addresses. Typically your ISP will provide the addresses of one or two DNS servers for your use. If you entered a DNS address during the ADSL modem router's configuration, reboot your computer and verify the DNS address as described in "[Preparing a Computer for Network Access](#)". Alternatively, you can configure your computer manually with DNS addresses, as explained in your operating system documentation.

- Your computer may not have the wireless ADSL modem router configured as its TCP/IP default gateway.

If your computer obtains its information from the ADSL modem router by DHCP, reboot the computer and verify the ADSL modem router address as described in "[Preparing a Computer for Network Access](#)".

Troubleshooting a TCP/IP Network Using the Ping Utility

Most TCP/IP terminal devices and routers contain a ping utility that sends an echo request packet to the designated device. The device then responds with an echo reply. Troubleshooting a TCP/IP network is made very easy by using the ping utility in your computer.

Testing the LAN Path to Your Router

You can ping the router from your computer to verify that the LAN path to your router is set up correctly.

To ping the router from a PC running Windows 95 or later:

1. From the Windows toolbar, click the Start button and select Run.
2. In the field provided, type Ping followed by the IP address of the router, as in this example:
ping 192.168.0.1
3. Click **OK**.

You should see a message like this one:

Pinging <IP address> with 32 bytes of data

If the path is working, you see this message:

Reply from < IP address >: bytes=32 time=NN ms TTL=xxx

If the path is not working, you see this message:

Request timed out

If the path is not functioning correctly, you could have one of the following problems:

- Wrong physical connections
 - Make sure the LAN port LED is on. If the LED is off, follow the instructions in [“LAN or ADSL Internet Port LEDs Not On”](#) on page 2-3.
 - Check that the corresponding Link LEDs are on for your network interface card and for the hub ports (if any) that are connected to your workstation and router.
- Wrong network configuration
 - Verify that the Ethernet card driver software and TCP/IP software are both installed and configured on your PC or workstation.
 - Verify that the IP address for your router and your workstation are correct and that the addresses are on the same subnet.

Testing the Path from Your Computer to a Remote Device

After verifying that the LAN path works correctly, test the path from your PC to a remote device. From the Windows run menu, type:

PING -n 10 <IP address>

where *<IP address>* is the IP address of a remote device such as your ISP's DNS server.

If the path is functioning correctly, replies as in the previous section are displayed. If you do not receive replies:

- Check that your PC has the IP address of your router listed as the default gateway. If the IP configuration of your PC is assigned by DHCP, this information will not be visible in your PC's Network Control Panel. Verify that the IP address of the router is listed as the TCP/IP default gateway as described in [“Preparing a Computer for Network Access”](#).
- Check to see that the network address of your PC (the portion of the IP address specified by the netmask) is different from the network address of the remote device.
- If your ISP assigned a host name to your PC, enter that host name as the Account Name in the Basic Settings menu.

Restoring the Default Configuration and Password

This section explains how to restore the factory default configuration settings, changing the router's administration password to **password** and the IP address to 192.168.0.1. You can erase the current configuration and restore factory defaults in two ways:

- Use the Erase function of the Web Configuration Manager.
- Use the Reset button on the rear panel of the router. Use this method for cases when the administration password or IP address is not known.

Using the Reset Button

To restore the factory default configuration settings without knowing the administration password or IP address, you must use the Default Reset button on the rear panel of the router.

1. Press and hold the Reset button until the Test LED turns on (about 10 seconds).
2. Release the Default Reset button and wait for the router to reboot.

Appendix A

Technical Specifications

This appendix provides technical specifications for the ADSL modem router.

Network Protocol and Standards Compatibility

Data and Routing Protocols: TCP/IP, RIP-1, RIP-2, DHCP, PPPoE or PPPoA, RFC 1483 Bridged or Routed Ethernet, and RFC 1577 Classical IP over ATM

Power Adapter

North America: 120V, 60 Hz, input
UK, Australia: 240V, 50 Hz, input
Europe: 230V, 50 Hz, input
Japan: 100V, 50/60 Hz, input
All regions (output): 12 V AC @ 1.0A output, 30W maximum

Physical

Dimensions: 10" x 6.7" x 1.3"
255 mm x 169 mm x 34 mm
Weight: 1.4 lbs.
0.62 kg

Environmental

Operating temperature: 0° to 40° C (32° to 104° F)
Operating humidity: 90% maximum relative humidity, noncondensing

Electromagnetic Emissions

Meets requirements of: FCC Part 15 Class B; VCCI Class B; EN 55 022 (CISPR 22), Class B

Interface Specifications

LAN: 10BASE-T or 100BASE-Tx, RJ-45
WAN: ADSL, Dual RJ-11, pins 2 and 3
T1.413, G.DMT, G.Lite
ITU Annex A or B

Appendix B

Related Documents

This appendix provides links to reference documents you can use to gain a more complete understanding of the technologies used in your NETGEAR product.

Document	Link
Internet Networking and TCP/IP Addressing	http://documentation.netgear.com/reference/enu/tcpip/index.htm
Wireless Communications	http://documentation.netgear.com/reference/enu/wireless/index.htm
Preparing a Computer for Network Access	http://documentation.netgear.com/reference/enu/wsdhcp/index.htm
Virtual Private Networking (VPN)	http://documentation.netgear.com/reference/enu/vpn/index.htm
Glossary	http://documentation.netgear.com/reference/enu/glossary/index.htm

