

IDEALARC[®] CV-250

For use with machine Code Numbers 10013, 10014

Safety Depends on You

Lincoln arc welding and cutting equipment is designed and built with safety in mind. However, your overall safety can be increased by proper installation ... and thoughtful operation on your part. **DO NOT INSTALL, OPERATE OR REPAIR THIS EQUIPMENT WITHOUT READING THIS MANUAL AND THE SAFETY PRECAUTIONS CONTAINED THROUGHOUT.** And, most importantly, think before you act and be careful.

Date of Purchase: _____

Serial Number: _____

Code Number: _____

Model: _____

Where Purchased: _____

OPERATOR'S MANUAL



• World's Leader in Welding and Cutting Products •

• Sales and Service through Subsidiaries and Distributors Worldwide •

Cleveland, Ohio 44117-1199 U.S.A. TEL: 216.481.8100 FAX: 216.486.1751 WEB SITE: www.lincolnelectric.com

⚠ WARNING

⚠ CALIFORNIA PROPOSITION 65 WARNINGS ⚠

Diesel engine exhaust and some of its constituents are known to the State of California to cause cancer, birth defects, and other reproductive harm.

The Above For Diesel Engines

The engine exhaust from this product contains chemicals known to the State of California to cause cancer, birth defects, or other reproductive harm.

The Above For Gasoline Engines

ARC WELDING CAN BE HAZARDOUS. PROTECT YOURSELF AND OTHERS FROM POSSIBLE SERIOUS INJURY OR DEATH. KEEP CHILDREN AWAY. PACEMAKER WEARERS SHOULD CONSULT WITH THEIR DOCTOR BEFORE OPERATING.

Read and understand the following safety highlights. For additional safety information, it is strongly recommended that you purchase a copy of "Safety in Welding & Cutting - ANSI Standard Z49.1" from the American Welding Society, P.O. Box 351040, Miami, Florida 33135 or CSA Standard W117.2-1974. A Free copy of "Arc Welding Safety" booklet E205 is available from the Lincoln Electric Company, 22801 St. Clair Avenue, Cleveland, Ohio 44117-1199.

BE SURE THAT ALL INSTALLATION, OPERATION, MAINTENANCE AND REPAIR PROCEDURES ARE PERFORMED ONLY BY QUALIFIED INDIVIDUALS.



FOR ENGINE powered equipment.

1.a. Turn the engine off before troubleshooting and maintenance work unless the maintenance work requires it to be running.



1.b. Operate engines in open, well-ventilated areas or vent the engine exhaust fumes outdoors.



1.c. Do not add the fuel near an open flame welding arc or when the engine is running. Stop the engine and allow it to cool before refueling to prevent spilled fuel from vaporizing on contact with hot engine parts and igniting. Do not spill fuel when filling tank. If fuel is spilled, wipe it up and do not start engine until fumes have been eliminated.

1.d. Keep all equipment safety guards, covers and devices in position and in good repair. Keep hands, hair, clothing and tools away from V-belts, gears, fans and all other moving parts when starting, operating or repairing equipment.

1.e. In some cases it may be necessary to remove safety guards to perform required maintenance. Remove guards only when necessary and replace them when the maintenance requiring their removal is complete. Always use the greatest care when working near moving parts.



1.f. Do not put your hands near the engine fan. Do not attempt to override the governor or idler by pushing on the throttle control rods while the engine is running.

1.g. To prevent accidentally starting gasoline engines while turning the engine or welding generator during maintenance work, disconnect the spark plug wires, distributor cap or magneto wire as appropriate.



1.h. To avoid scalding, do not remove the radiator pressure cap when the engine is hot.

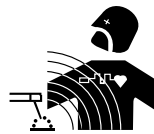

ELECTRIC AND MAGNETIC FIELDS may be dangerous

2.a. Electric current flowing through any conductor causes localized Electric and Magnetic Fields (EMF). Welding current creates EMF fields around welding cables and welding machines

2.b. EMF fields may interfere with some pacemakers, and welders having a pacemaker should consult their physician before welding.

2.c. Exposure to EMF fields in welding may have other health effects which are now not known.

2.d. All welders should use the following procedures in order to minimize exposure to EMF fields from the welding circuit:

2.d.1. Route the electrode and work cables together - Secure them with tape when possible.

2.d.2. Never coil the electrode lead around your body.

2.d.3. Do not place your body between the electrode and work cables. If the electrode cable is on your right side, the work cable should also be on your right side.

2.d.4. Connect the work cable to the workpiece as close as possible to the area being welded.

2.d.5. Do not work next to welding power source.

Mar '95



ELECTRIC SHOCK can kill.

- 3.a. The electrode and work (or ground) circuits are electrically "hot" when the welder is on. Do not touch these "hot" parts with your bare skin or wet clothing. Wear dry, hole-free gloves to insulate hands.
- 3.b. Insulate yourself from work and ground using dry insulation. Make certain the insulation is large enough to cover your full area of physical contact with work and ground.
- In addition to the normal safety precautions, if welding must be performed under electrically hazardous conditions (in damp locations or while wearing wet clothing; on metal structures such as floors, gratings or scaffolds; when in cramped positions such as sitting, kneeling or lying, if there is a high risk of unavoidable or accidental contact with the workpiece or ground) use the following equipment:**
- Semiautomatic DC Constant Voltage (Wire) Welder.
 - DC Manual (Stick) Welder.
 - AC Welder with Reduced Voltage Control.
- 3.c. In semiautomatic or automatic wire welding, the electrode, electrode reel, welding head, nozzle or semiautomatic welding gun are also electrically "hot".
- 3.d. Always be sure the work cable makes a good electrical connection with the metal being welded. The connection should be as close as possible to the area being welded.
- 3.e. Ground the work or metal to be welded to a good electrical (earth) ground.
- 3.f. Maintain the electrode holder, work clamp, welding cable and welding machine in good, safe operating condition. Replace damaged insulation.
- 3.g. Never dip the electrode in water for cooling.
- 3.h. Never simultaneously touch electrically "hot" parts of electrode holders connected to two welders because voltage between the two can be the total of the open circuit voltage of both welders.
- 3.i. When working above floor level, use a safety belt to protect yourself from a fall should you get a shock.
- 3.j. Also see Items 6.c. and 8.



ARC RAYS can burn.

- 4.a. Use a shield with the proper filter and cover plates to protect your eyes from sparks and the rays of the arc when welding or observing open arc welding. Headshield and filter lens should conform to ANSI Z87.1 standards.
- 4.b. Use suitable clothing made from durable flame-resistant material to protect your skin and that of your helpers from the arc rays.
- 4.c. Protect other nearby personnel with suitable, non-flammable screening and/or warn them not to watch the arc nor expose themselves to the arc rays or to hot spatter or metal.



FUMES AND GASES can be dangerous.

- 5.a. Welding may produce fumes and gases hazardous to health. Avoid breathing these fumes and gases. When welding, keep your head out of the fume. Use enough ventilation and/or exhaust at the arc to keep fumes and gases away from the breathing zone. **When welding with electrodes which require special ventilation such as stainless or hard facing (see instructions on container or MSDS) or on lead or cadmium plated steel and other metals or coatings which produce highly toxic fumes, keep exposure as low as possible and below Threshold Limit Values (TLV) using local exhaust or mechanical ventilation. In confined spaces or in some circumstances, outdoors, a respirator may be required. Additional precautions are also required when welding on galvanized steel.**
- 5.b. Do not weld in locations near chlorinated hydrocarbon vapors coming from degreasing, cleaning or spraying operations. The heat and rays of the arc can react with solvent vapors to form phosgene, a highly toxic gas, and other irritating products.
- 5.c. Shielding gases used for arc welding can displace air and cause injury or death. Always use enough ventilation, especially in confined areas, to insure breathing air is safe.
- 5.d. Read and understand the manufacturer's instructions for this equipment and the consumables to be used, including the material safety data sheet (MSDS) and follow your employer's safety practices. MSDS forms are available from your welding distributor or from the manufacturer.
- 5.e. Also see item 1.b.

Mar '95



WELDING SPARKS can cause fire or explosion.

6.a. Remove fire hazards from the welding area. If this is not possible, cover them to prevent the welding sparks from starting a fire.

Remember that welding sparks and hot materials from welding can easily go through small cracks and openings to adjacent areas. Avoid welding near hydraulic lines. Have a fire extinguisher readily available.

- 6.b. Where compressed gases are to be used at the job site, special precautions should be used to prevent hazardous situations. Refer to "Safety in Welding and Cutting" (ANSI Standard Z49.1) and the operating information for the equipment being used.
- 6.c. When not welding, make certain no part of the electrode circuit is touching the work or ground. Accidental contact can cause overheating and create a fire hazard.
- 6.d. Do not heat, cut or weld tanks, drums or containers until the proper steps have been taken to insure that such procedures will not cause flammable or toxic vapors from substances inside. They can cause an explosion even though they have been "cleaned". For information, purchase "Recommended Safe Practices for the Preparation for Welding and Cutting of Containers and Piping That Have Held Hazardous Substances", AWS F4.1 from the American Welding Society (see address above).
- 6.e. Vent hollow castings or containers before heating, cutting or welding. They may explode.
- 6.f. Sparks and spatter are thrown from the welding arc. Wear oil free protective garments such as leather gloves, heavy shirt, cuffless trousers, high shoes and a cap over your hair. Wear ear plugs when welding out of position or in confined places. Always wear safety glasses with side shields when in a welding area.
- 6.g. Connect the work cable to the work as close to the welding area as practical. Work cables connected to the building framework or other locations away from the welding area increase the possibility of the welding current passing through lifting chains, crane cables or other alternate circuits. This can create fire hazards or overheat lifting chains or cables until they fail.
- 6.h. Also see item 1.c.

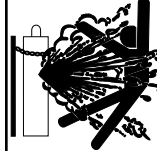

CYLINDER may explode if damaged.

7.a. Use only compressed gas cylinders containing the correct shielding gas for the process used and properly operating regulators designed for the gas and pressure used. All hoses, fittings, etc. should be suitable for the application and maintained in good condition.

- 7.b. Always keep cylinders in an upright position securely chained to an undercarriage or fixed support.
- 7.c. Cylinders should be located:
 - Away from areas where they may be struck or subjected to physical damage.
 - A safe distance from arc welding or cutting operations and any other source of heat, sparks, or flame.
- 7.d. Never allow the electrode, electrode holder or any other electrically "hot" parts to touch a cylinder.
- 7.e. Keep your head and face away from the cylinder valve outlet when opening the cylinder valve.
- 7.f. Valve protection caps should always be in place and hand tight except when the cylinder is in use or connected for use.
- 7.g. Read and follow the instructions on compressed gas cylinders, associated equipment, and CGA publication P-1, "Precautions for Safe Handling of Compressed Gases in Cylinders," available from the Compressed Gas Association 1235 Jefferson Davis Highway, Arlington, VA 22202.



FOR ELECTRICALLY powered equipment.

- 8.a. Turn off input power using the disconnect switch at the fuse box before working on the equipment.
- 8.b. Install equipment in accordance with the U.S. National Electrical Code, all local codes and the manufacturer's recommendations.
- 8.c. Ground the equipment in accordance with the U.S. National Electrical Code and the manufacturer's recommendations.

Mar '95

PRÉCAUTIONS DE SÛRETÉ

Pour votre propre protection lire et observer toutes les instructions et les précautions de sûreté spécifiques qui paraissent dans ce manuel aussi bien que les précautions de sûreté générales suivantes:

Sûreté Pour Soudage A L'Arc

1. Protégez-vous contre la secousse électrique:
 - a. Les circuits à l'électrode et à la pièce sont sous tension quand la machine à souder est en marche. Eviter toujours tout contact entre les parties sous tension et la peau nue ou les vêtements mouillés. Porter des gants secs et sans trous pour isoler les mains.
 - b. Faire très attention de bien s'isoler de la masse quand on soude dans des endroits humides, ou sur un plancher métallique ou des grilles métalliques, principalement dans les positions assis ou couché pour lesquelles une grande partie du corps peut être en contact avec la masse.
 - c. Maintenir le porte-électrode, la pince de masse, le câble de soudage et la machine à souder en bon et sûr état de fonctionnement.
 - d. Ne jamais plonger le porte-électrode dans l'eau pour le refroidir.
 - e. Ne jamais toucher simultanément les parties sous tension des porte-électrodes connectés à deux machines à souder parce que la tension entre les deux pinces peut être le total de la tension à vide des deux machines.
 - f. Si on utilise la machine à souder comme une source de courant pour soudage semi-automatique, ces précautions pour le porte-électrode s'appliquent aussi au pistolet de soudage.
2. Dans le cas de travail au dessus du niveau du sol, se protéger contre les chutes dans le cas où on reçoit un choc. Ne jamais enrouler le câble-électrode autour de n'importe quelle partie du corps.
3. Un coup d'arc peut être plus sévère qu'un coup de soleil, donc:
 - a. Utiliser un bon masque avec un verre filtrant approprié ainsi qu'un verre blanc afin de se protéger les yeux du rayonnement de l'arc et des projections quand on soude ou quand on regarde l'arc.
 - b. Porter des vêtements convenables afin de protéger la peau de soudeur et des aides contre le rayonnement de l'arc.
 - c. Protéger l'autre personnel travaillant à proximité au soudage à l'aide d'écrans appropriés et non-inflammables.
4. Des gouttes de laitier en fusion sont émises de l'arc de soudage. Se protéger avec des vêtements de protection libres de l'huile, tels que les gants en cuir, chemise épaisse, pantalons sans revers, et chaussures montantes.
5. Toujours porter des lunettes de sécurité dans la zone de soudage. Utiliser des lunettes avec écrans latéraux dans les zones où l'on pique le laitier.
6. Eloigner les matériaux inflammables ou les recouvrir afin de prévenir tout risque d'incendie dû aux étincelles.
7. Quand on ne soude pas, poser la pince à un endroit isolé de la masse. Un court-circuit accidentel peut provoquer un échauffement et un risque d'incendie.
8. S'assurer que la masse est connectée le plus près possible de la zone de travail qu'il est pratique de le faire. Si on place la masse sur la charpente de la construction ou d'autres endroits éloignés de la zone de travail, on augmente le risque de voir passer le courant de soudage par les chaînes de levage, câbles de grue, ou autres circuits. Cela peut provoquer des risques d'incendie ou d'échauffement des chaînes et des câbles jusqu'à ce qu'ils se rompent.
9. Assurer une ventilation suffisante dans la zone de soudage. Ceci est particulièrement important pour le soudage de tôles galvanisées plombées, ou cadmiées ou tout autre métal qui produit des fumées toxiques.
10. Ne pas souder en présence de vapeurs de chlore provenant d'opérations de dégraissage, nettoyage ou pistologie. La chaleur ou les rayons de l'arc peuvent réagir avec les vapeurs du solvant pour produire du phosgène (gas fortement toxique) ou autres produits irritants.
11. Pour obtenir de plus amples renseignements sur la sûreté, voir le code "Code for safety in welding and cutting" CSA Standard W 117.2-1974.

PRÉCAUTIONS DE SÛRETÉ POUR LES MACHINES À SOUDER À TRANSFORMATEUR ET À REDRESSEUR

1. Relier à la terre le châssis du poste conformément au code de l'électricité et aux recommandations du fabricant. Le dispositif de montage ou la pièce à souder doit être branché à une bonne mise à la terre.
2. Autant que possible, l'installation et l'entretien du poste seront effectués par un électricien qualifié.
3. Avant de faire des travaux à l'intérieur de poste, la débrancher à l'interrupteur à la boîte de fusibles.
4. Garder tous les couvercles et dispositifs de sûreté à leur

Mar. '93

Thank You — for selecting a **QUALITY** product by Lincoln Electric. We want you to take pride in operating this Lincoln Electric Company product ••• as much pride as we have in bringing this product to you!

Please Examine Carton and Equipment For Damage Immediately

When this equipment is shipped, title passes to the purchaser upon receipt by the carrier. Consequently, Claims for material damaged in shipment must be made by the purchaser against the transportation company at the time the shipment is received.

Please record your equipment identification information below for future reference. This information can be found on your machine nameplate.

Model Name & Number _____

Code & Serial Number _____

Date of Purchase _____

Whenever you request replacement parts for or information on this equipment always supply the information you have recorded above.

Read this Operators Manual completely before attempting to use this equipment. Save this manual and keep it handy for quick reference. Pay particular attention to the safety instructions we have provided for your protection. The level of seriousness to be applied to each is explained below:

⚠ WARNING

This statement appears where the information **must** be followed **exactly** to avoid **serious personal injury** or **loss of life**.

⚠ CAUTION

This statement appears where the information **must** be followed to avoid **minor personal injury** or **damage to this equipment**.

	Page
Installation	Section A
Technical Specifications	A-1
Select Suitable Location	A-2
Input Connections	A-2
Field Installed Options	A-3
Required Equipment - Control Cable Connections	A-3
Output Connections	A-3
Paralleling	A-4
Connection of Auxiliary Equipment to Wire Feeder Receptacle	A-4
<hr/>	
Operation	Section B
Safety Precautions	B-1
General Description	B-2
Recommended Processes and Equipment	B-2
Operational Features and Controls	B-2
Design Features	B-2
Limitations	B-2
Power Source Operation	B-2
Duty Cycle	B-2
Controls and Settings	B-3
Graphic Symbols	B-4
Output Panel Connections	B-5
Starting the Machine	B-6
Adjusting the Output Voltage using the Digital Meter	B-6
Local/Remote Switch Operation	B-6
Auxiliary Power	B-6
Overload Protection	B-6
<hr/>	
Accessories	Section C
Factory/Field Installed Options	C-1
Compatible Lincoln Equipment	C-1
<hr/>	
Maintenance	Section D
Safety Precautions	D-1
General Maintenance	D-1
Machine and Circuit Protection	D-1
<hr/>	
Troubleshooting	Section E
Safety Precautions	E-1
How to Use Troubleshooting Guide	E-1
Built-in Diagnostic Routines and Error Codes -Troubleshooting Guide	E-2
Machine -Troubleshooting Guide	E-3
Options -Troubleshooting Guide	E-6
Procedure for Replacing PC Boards	E-7
Control and Meter PC Board Troubleshooting Procedures	E-7
Output Voltage, Fault Protection, Snubber Circuit and K857 Remote Control Checks	E-8
<hr/>	
Diagrams	Section F
<hr/>	
Parts Manual	Appendix

TECHNICAL SPECIFICATIONS – IDEALARC CV-250

INPUT - THREE PHASE ONLY			
Standard Voltage 208/230/460/3/60	Input Current at Rated Output 100% Duty Cycle 56/51/26 60% Duty Cycle 62/56/28	Code Number 10013	
230/460/575/3/60	100% Duty Cycle 51/26/20 60% Duty Cycle 56/28/22	10014	
RATED OUTPUT			
Duty Cycle 100% Duty Cycle NEMA Class I (100) 60% Duty Cycle 100% Duty Cycle	Amps 250 300 250	Volts at Rated Amperes 30 32 30	
OUTPUT			
Welding Current/Voltage Range (Continuous) 30A/7V - 300A/32V DC	Normal Open Circuit Voltage 10-43 MAX OCV: 50	Auxiliary Power 42 Volts AC, 10 Amps 115 Volts AC, 5 Amps (Both Circuit Breaker Protected)	
MISC. INFORMATION			
Efficiency at 100% Load 72%	Input kVA 60% Load - 22.3 100% Load - 20.3	Idle Current - Amps 11/10/5	
Idle Power 800W	Power Factor at 100% Load .53		
PHYSICAL DIMENSIONS			
Height 21.5 in.	Width 19.5 in. (Lift bail, add 3.12 in)	Depth 27.0 in.	Weight 300 lbs (137 kg)
546 mm	495 mm (Lift bail, add 80 mm)	686 mm	

CV-250



Read entire installation section before starting installation.

SAFETY PRECAUTIONS

⚠ WARNING



ELECTRIC SHOCK can kill.

- Only qualified personnel should perform this installation.
- Turn the input power OFF at the disconnect switch or fuse box before working on this equipment.
- Turn the Power switch on the CV-250 "OFF" before connecting or disconnecting output cables, wire feeder or remote connections, or other equipment.
- Do not touch electrically hot parts.
- Always connect the Idealarc CV-250 grounding terminal (located on the welder base near the reconnect panel) to a good electrical earth ground.

SELECT SUITABLE LOCATION

Place the welder where clean cooling air can freely circulate in through the side louvers and out through the rear louvers. Dirt, dust or any foreign material that can be drawn into the welder should be kept at a minimum. Failure to observe these precautions can result in excessive operating temperatures and nuisance shut-downs. Idealarc CV-250 power sources carry an IP23 enclosure rating. They are rated for use in damp, dirty environments subject to occasional falling water such as rain.

STACKING

The CV-250 may be stacked three-high provided the bottom machine is on a stable, hard, level surface. Be sure that the two pins in the roof fit into the slots in the base of the CV-250 above it.

TILTING

Do not place the machine on a surface that is inclined enough to create a risk of the machine falling over.

INPUT CONNECTIONS

Be sure the voltage, phase, and frequency of the input power is as specified on the welder nameplate.

Gain access to the input reconnect panel by removing the right case side of the CV-250 (side nearest to the Power switch.)

Have a qualified electrician connect the input leads to L1, L2, and L3 of the input reconnect panel in accordance with the National Electrical Code, all local codes, and the connection diagram located on the inside of the right case side. Use a three phase line.

The frame of the welder must be grounded. A ground terminal marked with the symbol \oplus located on the base of the machine is provided for this purpose. See the National Electrical Code for details on proper grounding methods.

Fuse the input circuit with the recommended super lag fuses. Choose an input and grounding wire size according to local codes or use the following table. "Delay type"¹ circuit breakers may be used in place of fuses. Using fuses or circuit breakers smaller than recommended may result in "nuisance" tripping from welder inrush currents even if not welding at high currents.

RECOMMENDED INPUT WIRE AND FUSE SIZES

Input Voltage / Frequency	Fuse (Super Lag) or Breaker Size	Input Ampere Rating on Nameplate	Type 75°C Copper Wire in Conduit AWG (IEC) Sizes	Type 75°C Copper Ground Wire in Conduit AWG (IEC) Sizes
208/60	90	56	6 (16mm ²)	8 (10mm ²)
230/60	80	51	6 (16mm ²)	8 (10mm ²)
460/60	40	26	10 (6mm ²)	10 (6mm ²)
575/60	30	20	10 (6mm ²)	10 (6mm ²)
200/50/60	90	59	4 (25 mm ²)	8 (10mm ²)
220/50/60	80	54	6 (16mm ²)	8 (10mm ²)
230/50/60	80	52	6 (16mm ²)	8 (10mm ²)
380/50/60	50	31	8 (10mm ²)	10 (6mm ²)
400/50/60	45	30	10 (6mm ²)	10 (6mm ²)
415/50/60	45	29	10 (6mm ²)	10 (6mm ²)
440/50/60	45	27	10 (6mm ²)	10 (6mm ²)
500/50/60	40	24	10 (6mm ²)	10 (6mm ²)

¹Also called "inverse time" or "thermal/magnetic" circuit breakers; circuit breakers which have a delay in tripping action that decreases as the magnitude of the current increases.

FIELD INSTALLED OPTIONS

For installation of compatible field installed options (see the ACCESSORIES section of this manual and refer to the instructions included with those options.

REQUIRED EQUIPMENT-CONTROL CABLE CONNECTIONS

Follow the instructions below which are appropriate for the wire feeder that will be used.

LN-7 to CV-250

- Turn the CV-250 Power switch to the "OFF" position.
- Connect the LN-7 control cable to the wire feeder receptacle on the CV-250.
- See OUTPUT CONNECTIONS for connection of work and electrode cables.

LN-25 to CV-250

- Turn the CV-250 Power switch to the "OFF" position.
- Plug a K484 jumper plug into the CV-250 wire feeder receptacle.
- See OUTPUT CONNECTIONS for connection of work and electrode cables.

WARNING

The output terminals are energized at all times when the K484 is plugged in.

LN-742 to CV-250

- Turn the CV-250 Power switch to the "OFF" position.
- Connect the LN-742 control cable to the wire feeder receptacle on the CV-250.
- See OUTPUT CONNECTIONS for connection of work and electrode cables.

Connection of Remote Control (K857)

NOTE: The K864 Remote Control Adapter is required to install the K857.

Plug the K864 Remote Control Adapter into the power source's 14-pin receptacle. Plug the K857 Remote Control into the 6-pin receptacle of the K864 adapter. If possible, tape the Remote cable to the heavy output leads, so they can protect the smaller Remote cable from damage and abuse.

OUTPUT CONNECTIONS

Output cables must have Magnum Twist-Mate™ plugs for connection to the CV-250. Order K852-70 for connecting 1/0-2/0 (50-70 mm²) cables. Refer to S18737 for instructions on installing these plugs.

Use the shortest possible cable lengths. See Table A.1 for recommended cable sizes based on length.



Connect the positive output lead to the terminal marked "+". The negative output lead can be hooked to either the low inductance terminal (marked ") or the high inductance terminal (marked ")".

TABLE A.1
Cable Sizes for Combined Lengths of Copper
Electrode and Work Cable

Machine Size	Lengths up to 150 ft	150 to 200 ft
250 A 100% (300 A 60%)	1/0 (50mm ²)	2/0 (95mm ²)

PARALLELING

The CV-250 is not designed to be paralleled with any other power source.

CONNECTION OF AUXILIARY EQUIPMENT TO THE WIRE FEEDER RECEPTACLE

Occasionally, it may be necessary to make connection to the circuits present in the 14-pin wire feeder receptacle. These circuits, such as the auxiliary voltage, contactor, and remote control circuits, may be accessed with a K867 Universal Adapter. This adapter plugs into the receptacle and provides the user with short wire leads for connections. Refer to the instructions provided with the K867, as well as the wiring diagram for the CV-250 power source, for details on making those connections. For your convenience, wire feeder connection details are shown in the DIAGRAM section.

NOTE: If you intend to use a standard Lincoln wire feeder, order the appropriate input cable for the specific feeder. It will make all of the control and power connections between the CV-250 and the wire feeder WITHOUT the need for a K867 Universal Adapter.

OPERATING INSTRUCTIONS

Read and understand this entire section before operating the machine.

GENERAL WARNINGS

SAFETY PRECAUTIONS

WARNING



ELECTRIC SHOCK can kill.

- Do not touch electrically live parts or electrode with skin or wet clothing.
- Insulate yourself from work and ground.
- Always wear dry insulating gloves.



FUMES AND GASES can be dangerous.

- Keep your head out of fumes.
- Use ventilation or exhaust to remove fumes from breathing zone.

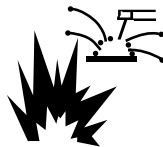

WELDING SPARKS can cause fire or explosion

- Keep flammable material away.
- Do not weld on containers that have held combustibles.



ARC RAYS can burn.

- Wear eye, ear and body protection.

Observe additional Safety Guidelines detailed throughout of this manual.

⚠ CAUTION

When using a CV-250 power source with wire feeders, there will be a small spark if the electrode contacts the work or ground within several seconds after releasing the trigger.

When used with some wire feeders with the electrical trigger interlock in the ON position, the arc might restart if the electrode touches the work or ground during these several seconds.

GENERAL DESCRIPTION

The CV-250 is a constant voltage DC power source designed for the GMAW process with limited FCAW capability as well. It features an industrial rating of 250 amps, 30 volts, at 100% duty cycle. It complies with the requirements for a NEMA Class I (100) power source.

It is available from the factory in one model only, with no options other than input voltage or frequency.

RECOMMENDED PROCESSES AND EQUIPMENT

The CV-250 is capable of solid wire welding within the rated output capacity of the machine. It is also capable of welding with the following flux-cored wires: NR-152, NR-211, NS-3M, NR-203 Ni 1%, and Outershield® 70 and 71.

The CV-250 is recommended for use with the LN-7, LN-742 and LN-25 wire feeder models.

OPERATIONAL FEATURES AND CONTROLS

- Two inductance positions: operator can choose the optimum output characteristics.
- Solid State Output Contactor: no noise, no moving parts to wear.
- Digital Voltmeter/Ammeter is standard.
- Power on/off switch.
- 42 VAC, 10 amp auxiliary power available for the wire feeder.

- Circuit breaker protected.
- 115 VAC, 5 amp auxiliary power available for the wire feeder; circuit breaker protected.
- Magnum Twist-Mate™ output receptacles.
- Single MS-type (14-pin) connection for wire feeder.
- Solid state controls, with line voltage compensation.
- Optional remote control capability.

DESIGN FEATURES

- "Clean" appearance and simple controls -- easy to operate.
- Electronic and thermostatic protection from overloads.
- Submersion dipping of assembled transformer, choke, and rectifier in special sealing/insulating material gives extra protection against moisture and corrosive atmospheres.
- Microprocessor based Control PC Board has built-in diagnostic routines.
- Compact size, requires only 19" x 26" footprint.
- Modular construction for easy servicing.
- Recessed panels protect output studs and controls. Large safety margins and protective circuits protect rectifiers from transient voltages and high currents.

LIMITATIONS

The CV-250 is intended only for use with the following FCAW electrodes: NR-152, NR-211, NR-203 Ni 1%, NS-3M, Outershield 70 and 71. The machine has been designed primarily for the GMAW process.

POWER SOURCE OPERATION

Be sure the CV-250 is properly installed, and that all accessories are properly hooked up before attempting operation.

DUTY CYCLE

250 Amps, 30 Volts at 100%
300 Amps, 32 Volts at 60%

Duty Cycle is based on operation for a 10 minute period.

CONTROLS AND SETTINGS

All operator controls and adjustments are located on the case front of the CV-250. Refer to Figures B.1, and B.2 and corresponding explanations.

FIGURE B.1 - CONTROL PANEL

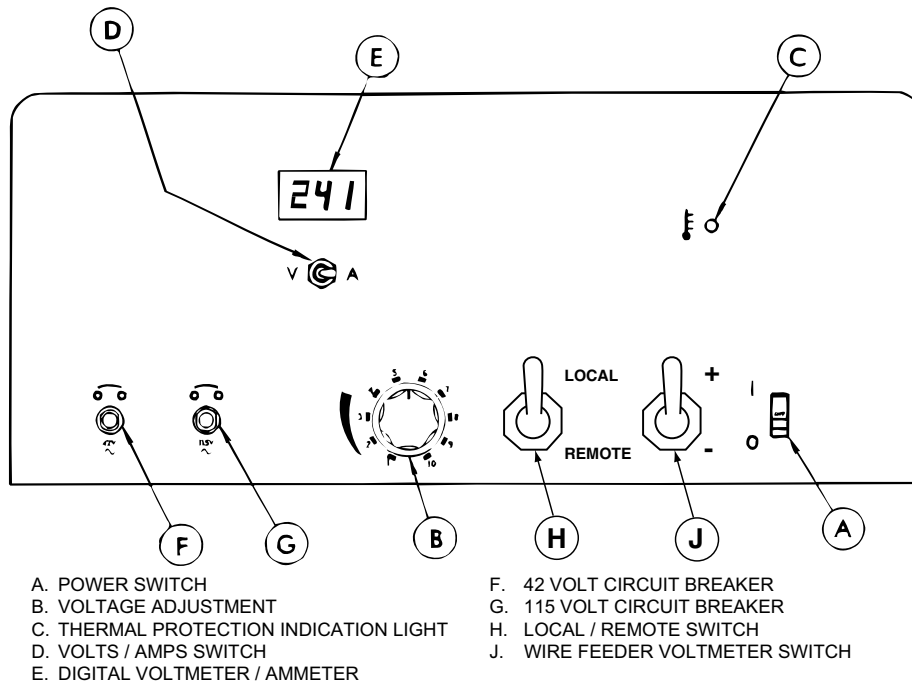

A. POWER SWITCH

- A two-position toggle switch. Controls the input power to the CV-250.

B. VOLTAGE ADJUST

- Controls the CV-250 output voltage.

C. THERMAL PROTECTION INDICATION LIGHT

- Indicates that the protection thermostat has activated. The digital meter will display "E10" when this occurs. When the light turns off, the machine will be capable of supplying welding output power again.

NOTE: Leaving the power switch in the "ON" position will result in the most rapid cooling.

D. VOLTS/AMPS SWITCH

- Selects either output current or arc voltage to be displayed on the digital meter.

E. DIGITAL VOLTMETER/AMMETER

- Displays the CV-250 output current, or the arc voltage.

NOTE: Due to voltage drops in the welding cables and at cable connection points, the actual arc voltage may be lower than that displayed on the voltmeter. Use welding cables of the proper capacity and make sure all connections are tight to minimize this effect.

F. 42 VOLT CIRCUIT BREAKER

- Protects the 42 volt 41-42 circuit in the wire feeder receptacle from overloads and shorts. If this circuit breaker opens, the CV-250 will work normally. However, any equipment powered by the 42 volt circuit will not work.

G. 115 VOLT CIRCUIT BREAKER

- Protects the 115 volt 31-32 circuit in the wire feeder receptacle from overloads and shorts. If this circuit breaker opens, the CV-250 will work normally. However, any equipment powered by the 115 volt circuit will not work.

H. LOCAL/REMOTE SWITCH

- Determines whether the welding voltage is controlled at the CV-250, or controlled remotely by a remote output control (such as a K857).

J. WIRE FEEDER VOLTMETER SWITCH

-This switch selects the polarity of the wire feeder voltmeter, if so equipped. When welding electrode positive (MIG, Outershield and some Innershield processes) set the switch to "+".

-When welding electrode negative (most Innershield electrodes) set the switch to "-".

-This switch has no effect on the welding polarity. In fact, if the wire feeder being used does not have a voltmeter, the setting of this switch has no effect.

GRAPHIC SYMBOLS THAT APPEAR ON THIS MACHINE OR IN THIS MANUAL



OFF



THERMAL PROTECTION INDICATOR LIGHT



ON



CIRCUIT BREAKER



AC POWER



CLOCKWISE ROTATION INCREASES VOLTAGE



REMOTE OUTPUT VOLTAGE CONTROL



LOCAL OUTPUT VOLTAGE CONTROL



INDICATES WARNING INFORMATION LOCATED ON RIGHT CASE SIDE

OUTPUT PANEL CONNECTIONS

FIGURE B.2 - OUTPUT PANEL

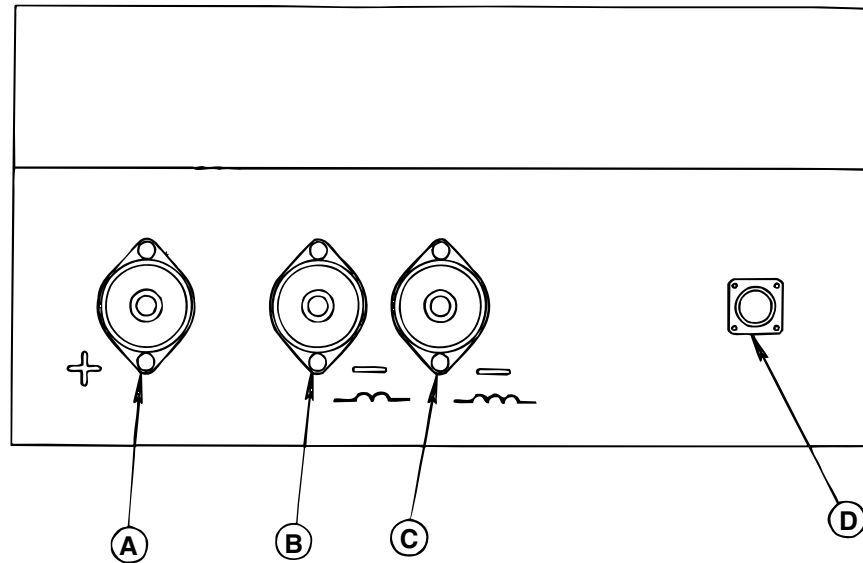

A. POSITIVE OUTPUT CONNECTION
B. LOW INDUCTANCE NEG. CONNECTION

C. HIGH INDUCTANCE NEG. CONNECTION
D. WIRE FEEDER RECEPTACLE

A., B., C. OUTPUT CONNECTORS

-Each connector is a Magnum Twist-Mate™, receptacle. Insert a mating Twist-Mate™ plug, and twist clockwise to secure.

For GMAW processes, and most FCAW processes, the positive output connection goes to the wire feeder. One of the negative output connections goes directly to the work.

A. POSITIVE OUTPUT CONNECTION.

B. LOW INDUCTANCE NEGATIVE CONNECTION.

-The low inductance connection is typically used for short arc welding of mild steel, particularly on thin materials or when using CO₂ shielding gas.

C. HIGH INDUCTANCE NEGATIVE OUTPUT CONNECTION.

-The high inductance connection is more suitable for short arc welding heavier weldments or when using 75% Argon/25% CO₂ shielding gas. This connection produces a softer arc and a flatter bead with more wash-in than the low inductance connection. A spray type transfer is possible with either connection.

D. WIRE FEEDER RECEPTACLE

-14-pin MS style receptacle for wire feeder. Provides connections for auxiliary power, contactor closure, remote output control, wire feeder voltmeter sense lead, and ground.

STARTING THE MACHINE

The power switch at the extreme right side of the control panel energizes the CV-250.

ADJUSTING THE OUTPUT VOLTAGE USING THE DIGITAL METER

The digital meters in the CV-250 incorporate a voltage preset function. This allows the operator to set the desired welding voltage before striking an arc. The digital meters can also display welding current.

To make use of the voltage preset function, the Volts/Amps switch must be in the "Volts" position. Turn the Voltage Adjust knob until the digital meter displays the desired welding voltage. (See below if an external power source remote control is installed.)

When an arc is struck, the digital meter displays the actual welding voltage, as measured at the CV-250 output terminals.

NOTE: The arc voltage at the electrode may be as much as two volts different from the CV-250 output terminal voltage. This is due to voltage drops present in the welding cables, cable connections, and welding gun. To minimize these drops, use cables of adequate capacity, and make sure all connections are clean and tight. Because of these voltage drops, you may have to preset the CV-250 for a slightly higher welding voltage than your procedure calls for.

To read welding current, set the Volts/Amps switch to the "Amps" position. The welding current will be displayed whenever an arc is struck.

LOCAL/REMOTE SWITCH OPERATION

If voltage control is desired at the CV-250, the Local/Remote switch must be in the "Local" position. The Voltage Adjust on the front panel can be used to adjust the CV-250 output. (The remote control, even if connected, will have no effect if the switch is in the "Local" position).

To use a remote control, such as the K857 (see INSTALLATION section), place the Local/Remote switch (see Figure B.1) in the "Remote" position. The remote control now controls the output voltage, in the manner described above. This control may be adjusted while welding to change the CV-250 output.

AUXILIARY POWER

42 volt AC auxiliary power, as required for some wire feeders, is available through the wire feeder receptacle. A 10 amp circuit breaker protects the 42 volt circuit from overloads.

CV-250 machines can also supply 115 volt AC auxiliary power through the wire feeder receptacle. A 5 amp circuit breaker protects the 115 volt circuit from overloads.

NOTE: Do not use circuits 2 or 4 for control of auxiliary loads. (The 2-4 circuit is isolated from the 31-32 and 41-42 circuits.)

CAUTION

Note that some types of equipment, especially pumps and large motors, have starting currents which are significantly higher than their running current. These higher starting currents may cause the circuit breaker to open. If this situation occurs, the user should refrain from using the CV-250 auxiliary power for that equipment.

OVERLOAD PROTECTION

This welder has thermostatic protection from excessive duty cycles, overloads, loss of cooling, and high ambient temperatures. When the welder is subjected to an overload or loss of cooling, a thermostat will open. This condition will be indicated by the illumination of the yellow Thermostatic Protection Light on the case front (see Figure B.1). The fan will continue to run to cool the power source. No welding is possible until the machine is allowed to cool and the Thermostatic Protection Light goes out.

FACTORY INSTALLED OPTIONS/ACCESSORIES

There are no factory installed options/accessories on the CV-250.

FIELD INSTALLED OPTIONS

REMOTE VOLTAGE CONTROL (K857)

The K857 consists of a control box with 25 feet (7.6 m) of four conductor cable. Installation of a K857 Remote Voltage Control in the CV-250 requires a K864 Remote Control Adapter. Refer to the instructions provided with the K857 for hookup to the CV-250. When properly connected, and with the CV-250 Local-Remote Switch in the "Remote" position, the K857 functions the same as the CV-250 Voltage Adjust control, enabling minimum to maximum output voltage adjustment of the CV-250.

UNDERCARRIAGE (K835)

Includes front casters, a handle, a bracket, and a rear wheeled platform that is capable of carrying one gas cylinder. The CV-250 lifting eye is not functional with the K835 undercarriage installed.

TWO-CYLINDER UNDERCARRIAGE (K874)

Platform type undercarriage that can accommodate either one or two gas bottles, or one gas bottle and a Magnum water cooler. The CV-250 lifting eye is not functional when the K874 undercarriage is installed.

WIRE FEEDER SWIVEL MOUNT (K178-1)

Allows an LN-7 or LN-742 to be securely mounted on the roof of a CV-250.

UNIVERSAL ADAPTER (K867)

Provides a means of connecting auxiliary equipment to the wire feeder receptacle on the CV-250 power source. Consists of a 14-pin MS-type (Amphenol) plug with 8 inch (0.2 meter) long flex leads, one for each circuit present in the wire feeder receptacle. Not required when using a standard wire feeder input cable, such as a K480, with a Lincoln wire feeder.

COMPATIBLE LINCOLN EQUIPMENT

The CV-250 is intended for use with the LN-7, LN-742, and LN-25 wire feed units. Use the Cables / Kits listed below to make connection easily:

LN-7 / LN-7GMA	Requires K480 Input Cable
LN-25	Requires K484 Jumper Plug Kit
LN-25 w/K444-1 Remote Voltage Control Kit	Requires K864 Remote Control Adapter and K484 Jumper Plug Kit
LN-742 / LN-742H	Requires K591 Input Cable

SAFETY PRECAUTIONS

WARNING



ELECTRIC SHOCK can kill.

- Only qualified personnel should perform this maintenance.
- Turn the input power OFF at the disconnect switch or fuse box before working on this equipment.
- Do not touch electrically hot parts.

GENERAL MAINTENANCE

1. The fan motor has sealed bearings which require no service.
2. In extremely dusty locations, dirt may clog the air channels causing the welder to run hot with premature tripping of thermal protection. Blow out the welder with low pressure air at regular intervals to eliminate excessive dirt and dust build-up on internal parts.

MACHINE AND CIRCUIT PROTECTION

The CV-250 Control PC Board has built-in diagnostic routines to alert the operator when trouble exists. When a trouble condition occurs, the CV-250 meter will display an error code, in the form "EXX", where "XX" refers to a specific error. See TROUBLESHOOTING section for an explanation of the error codes.

The power source is thermostatically protected against overload or insufficient cooling. If the machine is overloaded, the thermostat will open, thermal protection indicator light will turn on, and the output will be zero. The fan will continue to run and auxiliary power will still be available. The thermostat will remain open until the machine cools, at which time it will close and the output will again be available.

The CV-250 is electronically protected against overloads and accidental short circuits. The overload protection circuit automatically reduces the output current to a safe value when an overload is detected. If the circuitry senses a short circuit, it will shut off the CV-250 output. The short circuit protection circuit can be reset by turning the CV-250 Power switch OFF for at least 10 seconds. Remove the short before turning the Power switch ON again.

HOW TO USE TROUBLESHOOTING GUIDE

WARNING

Service and Repair should only be performed by Lincoln Electric Factory Trained Personnel. Unauthorized repairs performed on this equipment may result in danger to the technician and machine operator and will invalidate your factory warranty. For your safety and to avoid Electrical Shock, please observe all safety notes and precautions detailed throughout this manual.

This Troubleshooting Guide is provided to help you locate and remedy possible problems with machine setup or operation. Simply follow the three-step procedure listed below.

Step 1. LOCATE PROBLEM (SYMPTOM).

Look under the column labeled "PROBLEM (SYMPTOMS)". This column describes possible symptoms that the machine may exhibit. Find the listing that best describes the symptom that the machine is exhibiting.

Step 2. PERFORM EXTERNAL TESTS.

The second column labeled "POSSIBLE AREAS OF MISADJUSTMENT(S)" lists the obvious external possibilities that may contribute to the machine symptom. Perform these tests/checks in the order listed. In general, these tests can be conducted without removing the case wrap-around cover.

Step 3. PERFORM COMPONENT TESTS.

If you have exhausted all of the recommended tests in Step 2, Consult your Local Authorized Field Service Facility.

CAUTION

If for any reason you do not understand the test procedures or are unable to perform the tests/repairs safely, contact your **LOCAL AUTHORIZED LINCOLN ELECTRIC FIELD SERVICE FACILITY** for assistance before you proceed.

Observe all Safety Guidelines detailed throughout this manual

BUILT-IN DIAGNOSTIC ROUTINES AND ERROR CODES

The CV-250 Meter PC Board displays error codes when certain trouble conditions exist. The error codes, trouble conditions, and possible remedies are listed below.

ERROR CODE	TROUBLE	REMEDY
E00	<ol style="list-style-type: none"> Output short circuited. May be encountered while starting or welding with 1/16" aluminum wire. 	<ol style="list-style-type: none"> Turn power off. Remove short circuit. <ol style="list-style-type: none"> Turn power off to clear error. Use recommended wfs, voltage settings and angle of approach of wire to work. If problem still persists, call Local Lincoln Authorized Field Service Facility.
E10	Thermostat circuit has opened.	Allow machine to cool. Be sure to provide adequate ventilation for machine.
E20	Memory error.	See PC Board Troubleshooting Procedure.
E30	<ol style="list-style-type: none"> Voltage Adjust potentiometer not connected. Remote Control not functioning correctly. 	<ol style="list-style-type: none"> Check wiring between Voltage Adjust and the Control PC Board. See Options Troubleshooting Guide.
E40	Input line voltage too low.	Turn power off. Insure machine input voltage is within specifications. Turn power back on.
E50	Input line voltage too high.	Turn power off. Insure machine input voltage is within specifications. Turn power back on.
E60	Overload condition.	Reduce load on machine.

If, after attempting the remedies listed above, the error condition still exists, the problem may be with the wiring in the following areas: the shunt (leads 218 and 219), or voltage feedback (leads 213B, 214B and 224B).

CAUTION

If for any reason you do not understand the test procedures or are unable to perform the tests/repairs safely, contact your **Local Lincoln Authorized Field Service Facility** for technical troubleshooting assistance before you proceed.

Observe all Safety Guidelines detailed throughout this manual

MACHINE TROUBLESHOOTING GUIDE

Not all trouble conditions can be recognized by the PC board, and displayed as error codes. The following guide covers most other trouble conditions.

PROBLEMS (SYMPTOMS)	POSSIBLE AREAS OF MISADJUSTMENTS(S)	RECOMMENDED COURSE OF ACTION
PROBLEMS		
Machine has no output.	<ol style="list-style-type: none"> 1. Secondary contactor circuit (2 and 4 wire feeder receptacle) not working. 2. Electrode or work lead loose or broken. 3. Defective PC Board. 4. Protective circuits operating due to output short circuit. 5. If using an LN-25, K484 jumper plug kit not making connection between 2 & 4 in wire feeder receptacle. 6. If welding with 1/16" aluminum wire and machine is flashing E00. 	<ol style="list-style-type: none"> 1. Check 2 and 4 circuit wiring. 2. Repair connection. 3. See PC Board Troubleshooting Procedure. 4. Turn power off. Remove output short circuit. 5. Check for continuity between pins C & D in the K484. 6. a) Turn power off to clear error. Use recommended wfs, voltage settings and angle of approach of wire to work. b) If problem still persists, call Local Lincoln Authorized Field Service Facility.
Machine has minimum output and no control.	<ol style="list-style-type: none"> 1. Voltage Control misconnected. 	<ol style="list-style-type: none"> 1. Voltage Control wiring.
Machine has low output and no control.	<ol style="list-style-type: none"> 1. Open in feedback circuitry. 2. Faulty PC Board. 3. Voltage Adjust potentiometer circuit open (lead 75). 	<ol style="list-style-type: none"> 1. Check wiring and control and PC board wiring harness plugs. 2. See PC Board Troubleshooting Procedure. 3. Check and replace potentiometer if faulty. Check wiring of lead #75.

CAUTION

If for any reason you do not understand the test procedures or are unable to perform the tests/repairs safely, contact your **Local Lincoln Authorized Field Service Facility** for technical troubleshooting assistance before you proceed.

Observe all Safety Guidelines detailed throughout this manual

PROBLEMS (SYMPTOMS)	POSSIBLE AREAS OF MISADJUSTMENTS(S)	RECOMMENDED COURSE OF ACTION
PROBLEMS		
Thermal Protection Indicator light is on.	<ol style="list-style-type: none"> 1. Thermostat circuit has opened. 2. Faulty Control PC Board. 	<ol style="list-style-type: none"> 1. Allow machine to cool. Be sure to provide adequate ventilation for machine. 2. See PC Board Troubleshooting Procedure.
Machine does not have maximum output	<ol style="list-style-type: none"> 1. Faulty Control PC Board. 2. Voltage Adjust potentiometer defective. 3. Voltage Adjust potentiometer leads open. 	<ol style="list-style-type: none"> 1. See PC Board Troubleshooting Procedure. 2. Check and replace if faulty. 3. Check and repair broken leads.
Machine will not shut off.	<ol style="list-style-type: none"> 1. Defective power switch. 	<ol style="list-style-type: none"> 1. Replace.
Variable or sluggish welding arc.	<ol style="list-style-type: none"> 1. Poor work or electrode connection. 2. Welding leads too small. 3. Welding current or voltage too low. 4. Defective SCR bridge. 	<ol style="list-style-type: none"> 1. Check and clean all connections. 2. Check table in this manual. 3. Check procedures for recommended settings. 4. Check and replace if defective.
Digital meters do not light - or - Digital meter display is incorrect.	<ol style="list-style-type: none"> 1. Faulty Meter PC board. 2. Faulty Control PC Board. 	<ol style="list-style-type: none"> 1. See PC Board Troubleshooting Procedure. 2. See PC Board Troubleshooting Procedure.

 **CAUTION**

If for any reason you do not understand the test procedures or are unable to perform the tests/repairs safely, contact your **Local Lincoln Authorized Field Service Facility** for technical troubleshooting assistance before you proceed.

Observe all Safety Guidelines detailed throughout this manual

PROBLEMS (SYMPTOMS)	POSSIBLE AREAS OF MISADJUSTMENTS(S)	RECOMMENDED COURSE OF ACTION
PROBLEMS		
Poor arc striking with semiautomatic wire feeders.	<ol style="list-style-type: none"> 1. Poor work connection. 2. Improper procedures. 3. Wire feed acceleration too fast or too slow. 4. Defective PC Board. 	<ol style="list-style-type: none"> 1. Work connection must be adequate for application. 2. Adjust procedures for improved starting. 3. Adjust wire feeder acceleration setting, if provided. 4. See PC Board Troubleshooting Procedure.
Poor arc characteristics	<ol style="list-style-type: none"> 1. Control PC Board defective. 	<ol style="list-style-type: none"> 1. See PC Board Troubleshooting Procedure.

 **CAUTION**

If for any reason you do not understand the test procedures or are unable to perform the tests/repairs safely, contact your **Local Lincoln Authorized Field Service Facility** for technical troubleshooting assistance before you proceed.

CV-250



Observe all Safety Guidelines detailed throughout this manual

OPTIONS TROUBLESHOOTING GUIDE

K857 (or other) Remote Output Control

PROBLEMS (SYMPTOMS)	POSSIBLE AREAS OF MISADJUSTMENTS(S)	RECOMMENDED COURSE OF ACTION
PROBLEMS		
Voltage control not functioning on Remote Control.	<ol style="list-style-type: none"> 1. Local/Remote switch in wrong position. 2. Faulty Local/Remote switch. 3. Faulty Remote Control potentiometer. 4. Leads or connections open in control circuit. 5. Faulty Control PC board. 	<ol style="list-style-type: none"> 1. Place switch in "Remote". 2. Check and replace if found faulty. 3. Check and replace if found faulty. 4. Check all leads and connections, internal or remote, for continuity; repair if necessary. 5. See PC Board Troubleshooting Procedure.
Voltage Adjust not functioning on the machine.	<ol style="list-style-type: none"> 1. Local/Remote switch in the wrong position. 2. Faulty Local/Remote switch. 3. Faulty Voltage Adjust potentiometer. 4. Leads or connections open in control circuit. 5. Faulty Control PC board. 	<ol style="list-style-type: none"> 1. Place switch in "Local" position. 2. Check and replace if found faulty. 3. Check and replace if found faulty. 4. Check all leads and connections, internal or remote, for continuity; repair if necessary. 5. See PC Board Troubleshooting Procedure.

CAUTION

If for any reason you do not understand the test procedures or are unable to perform the tests/repairs safely, contact your **Local Lincoln Authorized Field Service Facility** for technical troubleshooting assistance before you proceed.

Procedure for Replacing PC Boards

WARNING



ELECTRIC SHOCK can kill.

- Have a qualified individual install and service this equipment.
- Turn the power source input power off at the disconnect switch before working on this equipment.
- Do not touch electrically hot parts.

Before replacing a PC board which is suspected of being defective, visually inspect the PC board in question for any electrical or mechanical damage to any of its components and conductors on the back of the board.

- a. If there is no visible damage to the PC board, install a new one and see if this remedies the problem. If the problem is remedied, reinstall the old PC board to see if the problem still exists. If it does no longer exist with old PC board:
 1. Check the PC board harness connector pins for corrosion, contamination, or looseness.
 2. Check leads in the plug harness for loose or intermittent connection.
- b. If PC board is visibly damaged electrically, before possibly subjecting the new PC board to the same cause of failure, check for possible shorts, opens, or grounds caused by:
 1. Frayed or pinched lead insulation.
 2. Poor lead termination, such as a poor contact or a short to adjacent connection or surface.
 3. Shorted or open motor leads, or other external leads.
 4. Foreign matter or interference behind the PC boards.
- c. If PC board is visibly damaged mechanically, inspect for cause, then remedy before installing a replacement PC board.

If there is damage to the PC board or if replacing PC board corrects problem, return it to the local Lincoln Electric Field Service Shop.

CAUTION

If for any reason you do not understand the test procedures or are unable to perform the tests/repairs safely, contact your **Local Lincoln Authorized Field Service Facility** for technical troubleshooting assistance before you proceed.

PC BOARD TROUBLESHOOTING PROCEDURES

CONTROL PC BOARD

The Control PC Board controls all machine functions including the thermal protection indicator light and the Meter PC Board. Most problems, if not caused by faulty wiring machine misuse, will stem from a faulty Control PC Board.

Perform the following diagnostic procedure before replacing the Control PC Board.

1. Turn off the input power at the fuse box.
2. Check for loose connections in the PC Board plugs, particularly J3.
3. Disconnect the J3 plug from the Control PC Board. Measure the resistance between the following wire terminals in the plug:

A) Between wire #200 and wire #201.

B) Between wire #202 and wire #203.

Both of these resistances should be less than 1 ohm.

If these resistances are not less than 1 ohm, check the wiring back to the main transformer.

If these voltages are less than 1 ohm, refer to "Procedure for Replacing PC Boards."

METER PC BOARD

When the Meter PC Board malfunctions, first determine if the rest of the machine functions correctly. If so, then the problem is in either the harness between the meter and control boards, or in the meter board itself. Refer to "Procedure for Replacing PC Boards". As a last resort, the Control PC Board may have to be replaced.

OUTPUT VOLTAGE

The open circuit voltage of the machine should be 10 to 43 volts. If any other condition exists, refer to the Troubleshooting Guide.

FAULT PROTECTION OPERATION

The overload protection circuit on the PC Board will cause the CV-250 meter to display "E60". This protection circuit will reset itself automatically. The short circuit protection circuit will cause the meter to display "E00". The CV-250 power switch must be turned "OFF" and then "ON" to return the machine to normal output.

CHECKING SNUBBER CIRCUIT

In case of an SCR malfunction or failure, the snubber assembly should be checked. Disconnect the input power to the CV-250 at the fuse box and remove the right side of the machine.

1. Visually inspect the snubber PC Board assembly (located below the Control PC board on the case front for overheated components or damaged components).

OPTIONAL K857 REMOTE CONTROL CHECK

Disconnect the remote output control and connect an ohmmeter between pins C and B and rotate the rheostat in the remote control. The resistance reading should go from zero to 10K ohms. Repeat with ohmmeter across A and B with the same results. Connect ohmmeter across A and C. The reading should be 10K ohms. A lower reading will indicate a shorted or partially shorted rheostat. A very high reading will indicate an open rheostat. In either of the last two cases, replace the rheostat.

CAUTION

If for any reason you do not understand the test procedures or are unable to perform the tests/repairs safely, contact your **Local Lincoln Authorized Field Service Facility** for technical troubleshooting assistance before you proceed.

WIRING DIAGRAM CV 250 (60Hz)

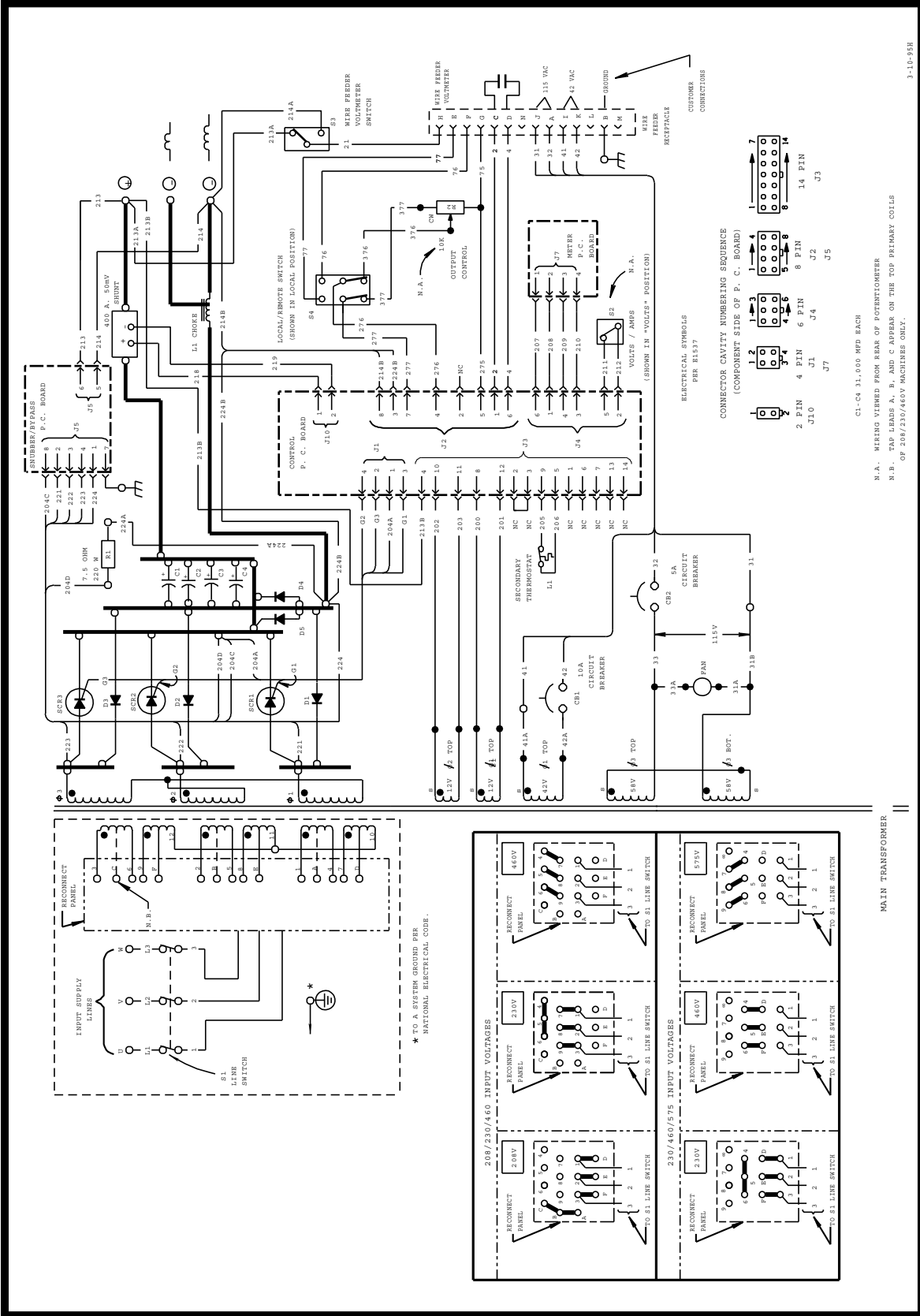

NOTE: This diagram is for reference only. It may not be accurate for all machines covered by this manual. The specific diagram for a particular code is pasted inside the machine on one of the enclosure panels. If the diagram is illegible, write to the Service Department for a replacement. Give the equipment code number..

CV POWER SOURCE TO AN LN-7 AND K857

<p>WARNING</p> 	<ul style="list-style-type: none"> ● Turn off input power to the Welding Power Source using the disconnect switch at the fuse box Before connecting the wire feeder. ● Only qualified persons should install, use or service this machine.
<p>ELECTRIC SHOCK CAN KILL</p>	

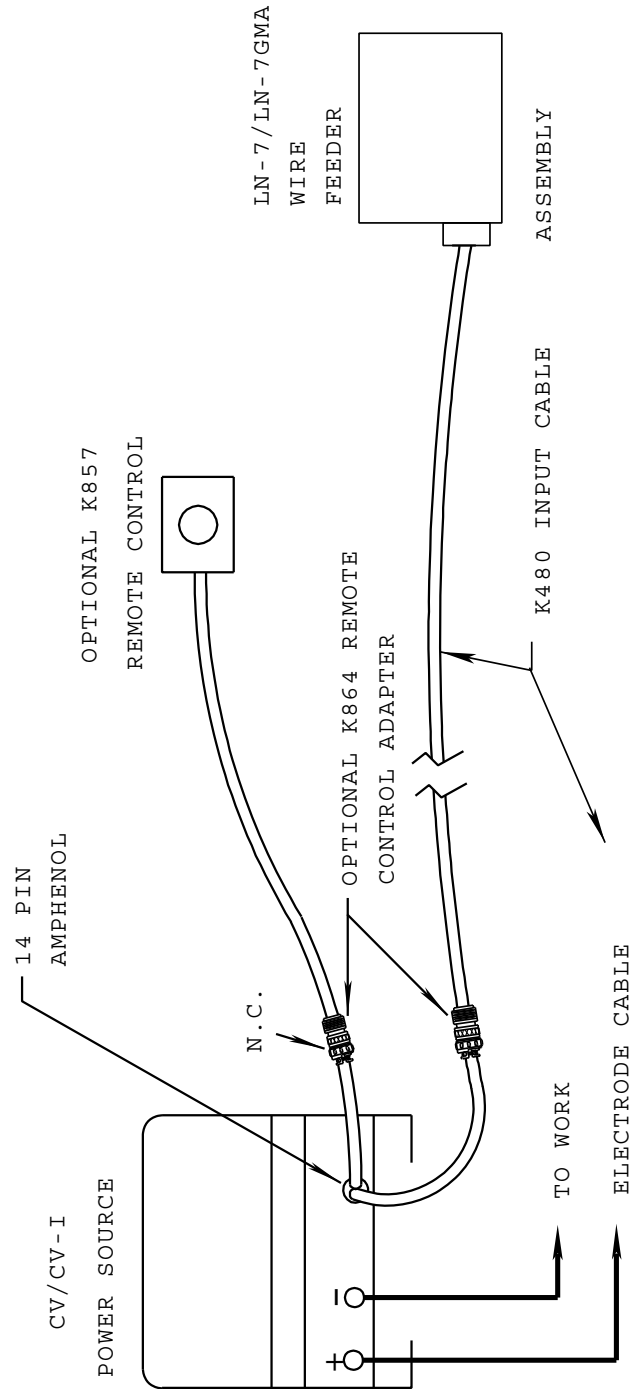

- N.A. WELDING CABLE MUST BE SIZED FOR CURRENT AND DUTY CYCLE OF APPLICATION.
- N.B. DIAGRAM SHOWS ELECTRODE POSITIVE. TO CHANGE POLARITY, TURN POWER "OFF",
- N.C. USE OF THE K857 REMOTE CONTROL REQUIRES THE INSTALLATION OF A K864 REMOTE CONTROL ADAPTER TO THE 14 PIN AMPHENOL OF THE POWER SOURCE.

6-18-93

520662

CV POWER SOURCE TO A K867 UNIVERSAL ADAPTER

WARNING

● Turn off input power to the Welding Power Source using the disconnect switch at the fuse box Before connecting the wire feeder.

● Only qualified persons should install, use or service this machine.

ELECTRIC SHOCK CAN KILL

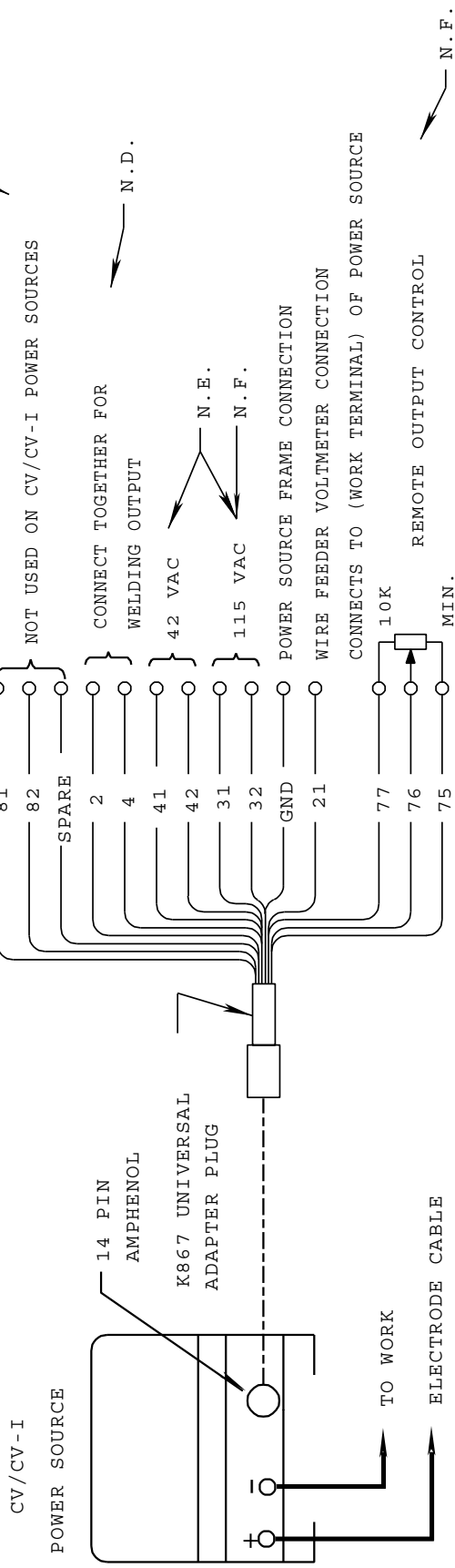

- N.A. WELDING CABLE MUST BE SIZED FOR CURRENT AND DUTY CYCLE OF APPLICATION.
- N.B. DIAGRAM SHOWS ELECTRODE POSITIVE. TO CHANGE POLARITY, TURN POWER "OFF", REVERSE ELECTRODE AND WORK CABLES AT POWER SOURCE.
- N.C. INSULATE EACH UNUSED LEAD INDIVIDUALLY.
- N.D. FOR WIRE FEEDERS THAT RETURN A SIGNAL FOR WELDING OUTPUT, USE ISOLATION RELAY TO CLOSE LEADS 2 & 4.
- N.E. REFER TO POWER SOURCE INSTRUCTION MANUAL FOR MAXIMUM AUXILIARY CURRENT DRAW.
- N.F. NOT PRESENT ON ALL MACHINES



6-18-93
S20658

CV POWER SOURCE TO A K867 / K775 / LN-7

<p>WARNING</p>	<ul style="list-style-type: none"> • Turn off input power to the Welding Power Source using the disconnect switch at the fuse box Before connecting the wire feeder. • Only qualified persons should install, use or service this machine.
<p>ELECTRIC SHOCK CAN KILL</p>	

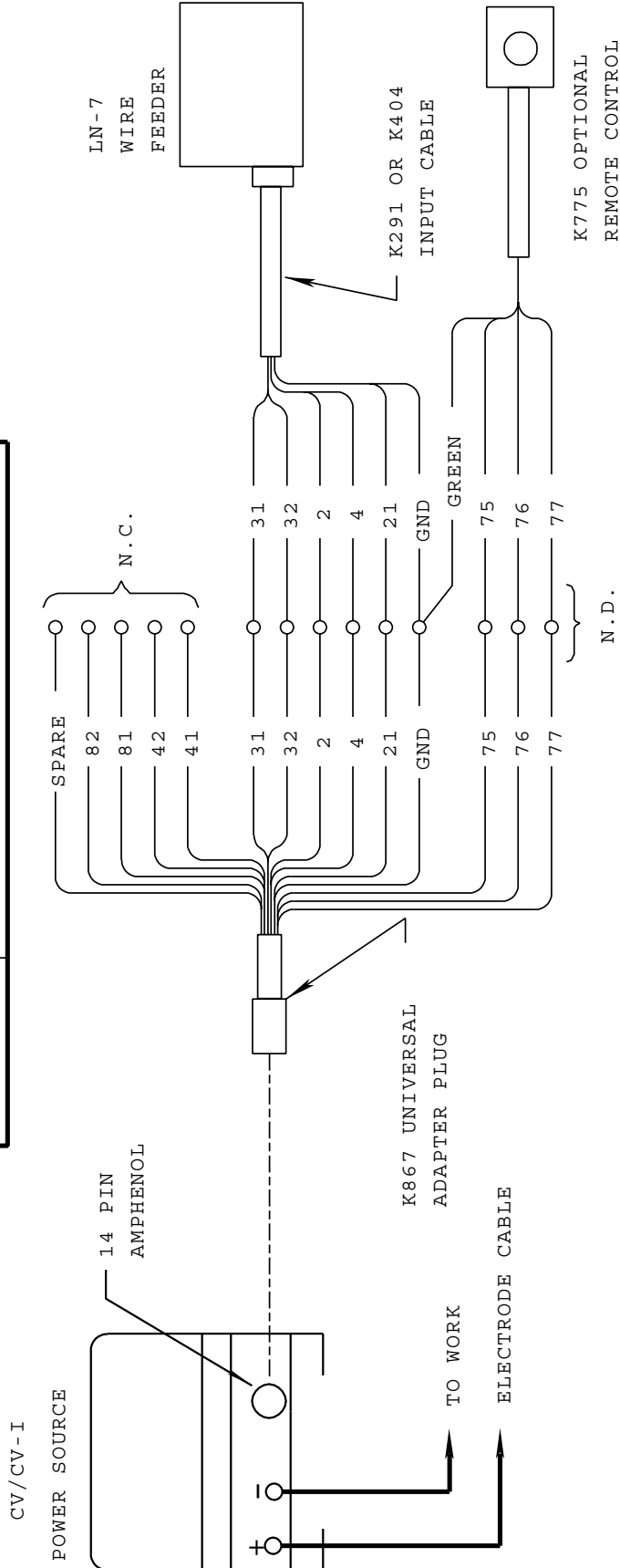

- N.A. WELDING CABLE MUST BE SIZED FOR CURRENT AND DUTY CYCLE OF APPLICATION.
- N.B. DIAGRAM SHOWS ELECTRODE POSITIVE. TO CHANGE POLARITY, TURN POWER "OFF", REVERSE ELECTRODE AND WORK CABLES AT POWER SOURCE.
- N.C. INSULATE EACH UNUSED LEAD INDIVIDUALLY.
- N.D. SPLICE LEADS AND INSULATE.

6-18-93
820659

CV POWER SOURCE TO AN LN-25

 <p>WARNING</p>	<ul style="list-style-type: none"> ● Turn off input power to the Welding Power Source using the disconnect switch at the fuse box Before connecting the wire feeder. ● Only qualified persons should install, use or service this machine.
<p>ELECTRIC SHOCK CAN KILL</p>	

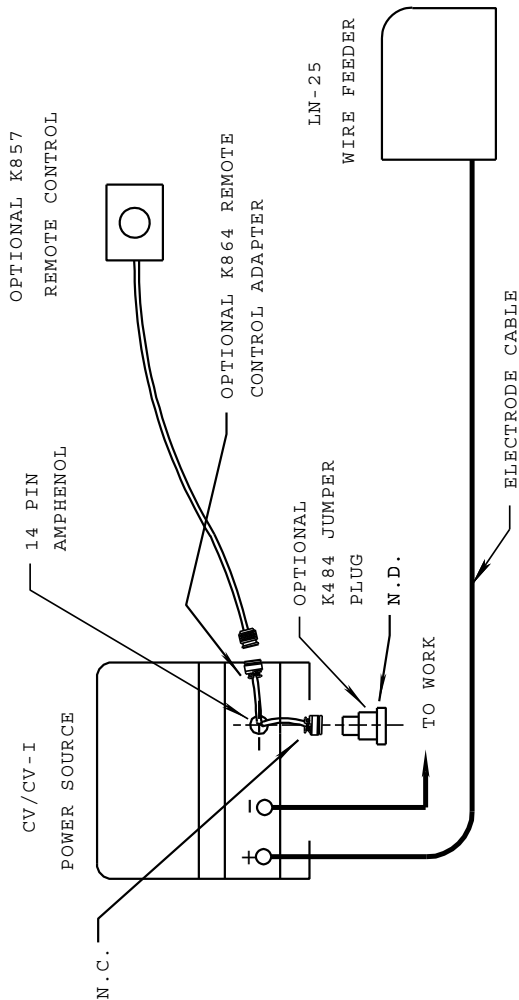

- N.A. WELDING CABLE MUST BE SIZED FOR CURRENT AND DUTY CYCLE OF APPLICATION.
- N.B. DIAGRAM SHOWS ELECTRODE POSITIVE. TO CHANGE POLARITY, TURN POWER "OFF", REVERSE ELECTRODE AND WORK CABLES AT POWER SOURCE.
- N.C. USE OF THE K857 REMOTE CONTROL REQUIRES INSTALLATION OF A K864 REMOTE CONTROL ADAPTER TO THE 14 PIN AMPHENOL OF THE POWER SOURCE.
- N.D. CONNECT THE K484 JUMPER PLUG DIRECTLY TO THE 14 PIN AMPHENOL OF THE POWER SOURCE IF NO REMOTE CONTROL IS USED.
- IF USING A K857 REMOTE CONTROL, CONNECT THE K484 JUMPER PLUG TO THE 14 PIN AMPHENOL OF THE K864 REMOTE CONTROL ADAPTER.
- THE POWER SOURCE WELDING TERMINALS ARE ALWAYS "HOT" WHEN THE K484 JUMPER

6-18-93

S20661

CV POWER SOURCE TO AN LN-25 / K444-1

CV/CV-I POWER SOURCE TO LN-25 WITH K444-1 OPTION CONNECTION DIAGRAM

 <p>WARNING</p>	<ul style="list-style-type: none"> • Turn off input power to the Welding Power Source using the disconnect switch at the fuse box Before connecting the wire feeder. • Only qualified persons should install, use or service this machine.
<p>ELECTRIC SHOCK CAN KILL</p>	

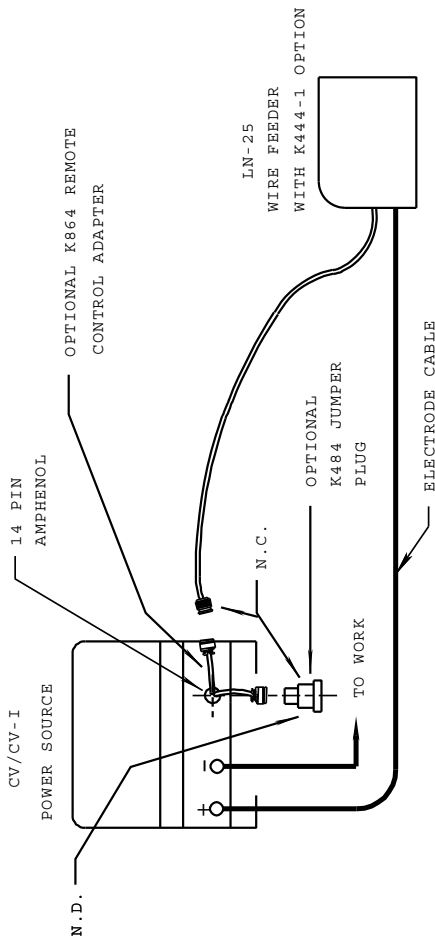

- N.A. WELDING CABLE MUST BE SIZED FOR CURRENT AND DUTY CYCLE OF APPLICATION.
- N.B. DIAGRAM SHOWS ELECTRODE POSITIVE. TO CHANGE POLARITY, TURN POWER "OFF", REVERSE ELECTRODE AND WORK CABLES AT POWER SOURCE, SWITCH LN-25 POLARITY SWITCH.
- N.C. CONNECT THE K484 JUMPER PLUG TO THE 14 PIN RECEPTACLE OF THE K864 REMOTE CONTROL ADAPTER. CONNECT THE 6 PIN PLUG FROM THE LN-25 (WITH K444-1 OPTION) TO THE 6 PIN RECEPTACLE OF THE K864 REMOTE CONTROL ADAPTER. SWITCH THE POWER SOURCE "LOCAL/REMOTE" SWITCH TO REMOTE.
- N.D. THE POWER SOURCE TERMINALS ARE ALWAYS "HOT" WHEN THE K484 JUMPER PLUG KIT IS INSTALLED.

6-18-93

S20663

CLEVELAND, OHIO U.S.A.

LINCOLN POWER SOURCE TO AN LN-742

<p>WARNING</p>	<ul style="list-style-type: none"> • Turn off (0) the power switch on the Welding Power Source before connecting the wire feeder. • Only qualified persons should install, use or service this machine.
<p>ELECTRIC SHOCK CAN KILL</p>	

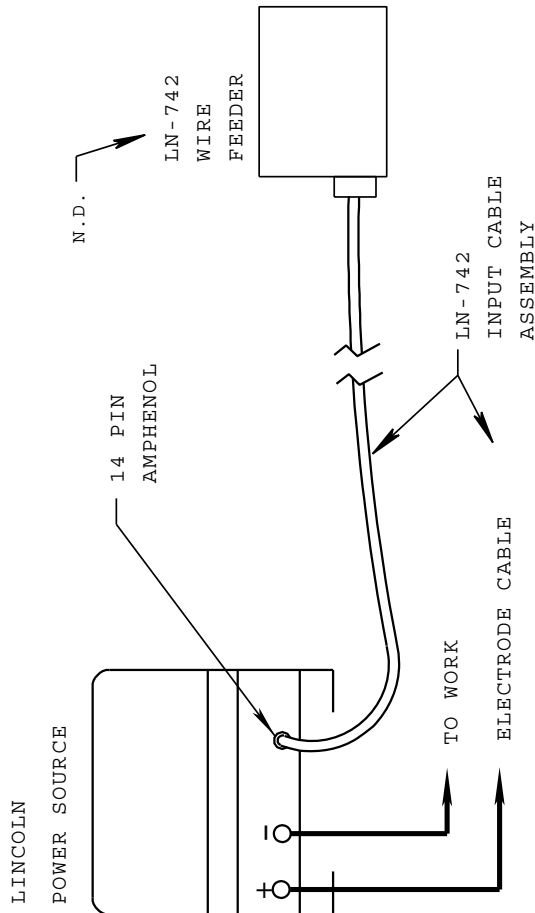

N.A. WELDING CABLE MUST BE SIZED FOR CURRENT AND DUTY CYCLE OF APPLICATION.

N.B. DIAGRAM SHOWS ELECTRODE POSITIVE. TO CHANGE POLARITY, TURN POWER "OFF", REVERSE ELECTRODE AND WORK CABLES AT POWER SOURCE AND SET WIRE FEEDER VOLT/METER POLARITY SWITCH ON POWER SOURCE TO PROPER POLARITY.

N.C. PINS NOT LISTED ARE NOT CONNECTED ON CABLE.

N.D. IF USING K589-1, REMOTE CONTROL KIT, SET POWER SOURCE CONTROL SWITCH TO "REMOTE" POSITION.

FUNCTIONS ARE LISTED FOR REFERENCE ONLY AND EACH MAY OR MAY NOT BE PRESENT IN YOUR EQUIPMENT. (SEE APPROPRIATE WIRING DIAGRAM)

PIN	LEAD	FUNCTION
C	2	TRIGGER CIRCUIT
D	4	TRIGGER CIRCUIT
E	77	OUTPUT CONTROL
F	76	OUTPUT CONTROL
G	75	OUTPUT CONTROL
H	21	WORK
I	41	42V AC
K	42	42V AC

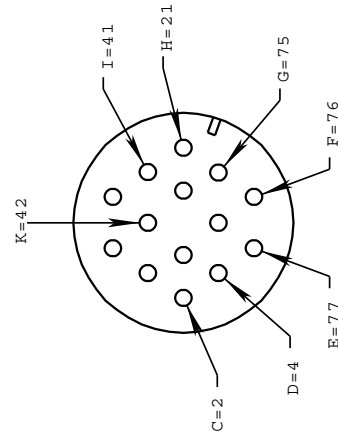

14-SOCKET BOX RECEPTACLE, FRONT VIEW AND 14-PIN CABLE PLUG, REAR VIEW

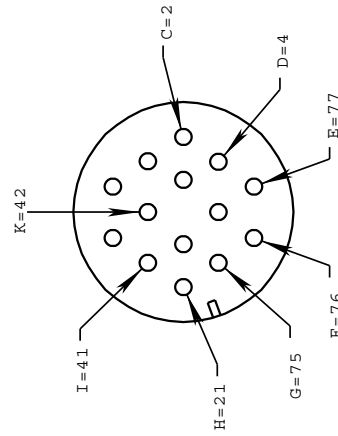

14-SOCKET BOX RECEPTACLE, REAR VIEW AND 14-PIN CABLE PLUG, FRONT VIEW

1-28-94
S206109

K867 UNIVERSAL ADAPTER INSTALLATION AND CONNECTION INSTRUCTIONS

INSTALLATION INSTRUCTIONS

THIS CONNECTOR IS MEANT TO BE USED WITH LINCOLN POWER SOURCES WHICH HAVE A 14-PIN WIRE FEEDER RECEPTACLE. IT IS DESIGNED TO ALLOW THE USER TO MAKE CONNECTIONS TO ANY OF THE 14 CIRCUITS PRESENT IN THE WIRE FEEDER RECEPTACLE.

CONSULT THE WIRING DIAGRAM OF THE POWER SOURCE AND WIRE FEEDER THIS ADAPTER WILL BE USED WITH. NOT ALL CIRCUITS ARE PRESENT IN EVERY POWER SOURCE, NOR ARE THEY REQUIRED FOR PROPER WIRE FEEDER OPERATION.

1. TURN THE POWER SWITCH OF THE WELDING POWER SOURCE OFF BEFORE INSTALLING THIS ADAPTER TO WIRE FEEDER CABLE.
2. CONSULT THE APPROPRIATE WIRING DIAGRAMS FOR THE CONNECTIONS TO UNIVERSAL ADAPTER.

THE STANDARD CONNECTOR PIN DESIGNATIONS AND FUNCTIONS ARE SHOWN BELOW.

NOTE: 115V AC (31, 32), 42V AC (41, 42), 24V AC (SPARE) AND TRIGGER CIRCUIT (2, 4)

MAY OR MAY NOT BE ISOLATED, INDEPENDENT CIRCUITS INSIDE THE WELDER.

3. USE LUG, CRIMP SPLICE OR SOLDER CONNECTIONS AS REQUIRED AND INSULATE EACH USED AND UNUSED LEAD IN THE UNIVERSAL ADAPTER. THE INSULATING METHOD MUST BE RATED FOR 120V AC OR GREATER.

(SEE APPROPRIATE WIRING DIAGRAM) THESE FUNCTIONS ARE LISTED FOR REFERENCE ONLY AND EACH MAY OR MAY NOT BE PRESENT IN YOUR EQUIPMENT.

PIN	LEAD	STANDARD FUNCTION
A	32	115V AC
B	GND	CHASSIS CONNECTION
C	2	TRIGGER CIRCUIT
D	4	TRIGGER CIRCUIT
E	77	OUTPUT CONTROL
F	76	OUTPUT CONTROL
G	75	OUTPUT CONTROL
H	21	WORK
I	41	42V AC
J	31	115V AC
K	42	42V AC
L	82	WELDING MODE CONTROL
M	81	WELDING MODE CONTROL
N	SPARE	24V AC

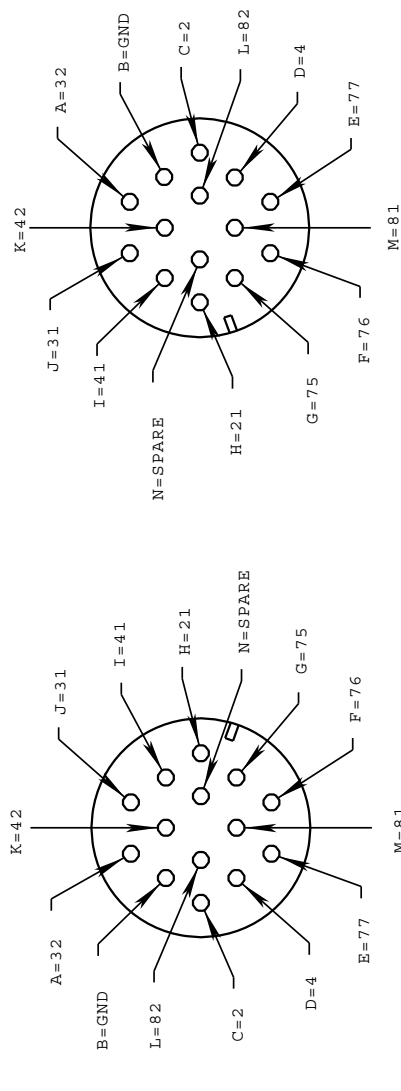

14-PIN BOX RECEPTACLE, FRONT VIEW AND 14-PIN CABLE PLUG, REAR VIEW

14-PIN BOX RECEPTACLE, REAR VIEW AND 14-PIN CABLE PLUG, FRONT VIEW

3-16-90
819386

TWIST-MATE CABLE PLUG INSTALLATION INSTRUCTIONS

TWIST-MATE WELDING CABLE PLUG INSTALLATION INSTRUCTIONS

⚠ WARNING:	ELECTRIC SHOCK CAN KILL
	<p>TURN THE POWER SWITCH OF THE WELDING POWER SOURCE "OFF" BEFORE INSTALLING PLUGS ON CABLES OR WHEN CONNECTING OR DISCONNECTING PLUGS TO WELDING POWER SOURCE.</p>

- CHECK THAT THE CONNECTOR BOOT IS MARKED FOR THE APPROPRIATE CABLE SIZE PER TABLE BELOW; AND SKIN CABLE JACKET TO LENGTH SPECIFIED:

BOOT MARKING	AMERICAN (EUROPEAN) RANGE CABLE SIZE	CABLE SKIN LENGTH
35-50	#2-#1 (35-50 mm) ²	1 INCH (25.4mm)
50-70	1/0-2/0 (50-70 mm) ²	1 INCH (25.4mm)
70-95	2/0-3/0 (70-95 mm) ²	1.5 INCH (38.1mm)

- If necessary, trim cable end of boot at groove(s) to match cable diameter. Boot must fit tightly enough to seal around outside diameter of cable. NOTE: Some boots are designed to accommodate different cable diameters without trimming. These boots do not have grooves at the cable end. Soap or other non petroleum based lubricant will help to slide the boot over the cable.
- Slide rubber boot onto cable end.

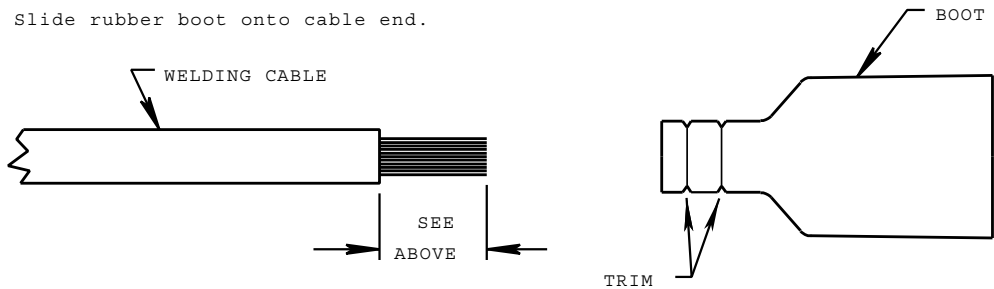

- Slide the copper tube into the brass plug.
- Insert cable into copper tube.

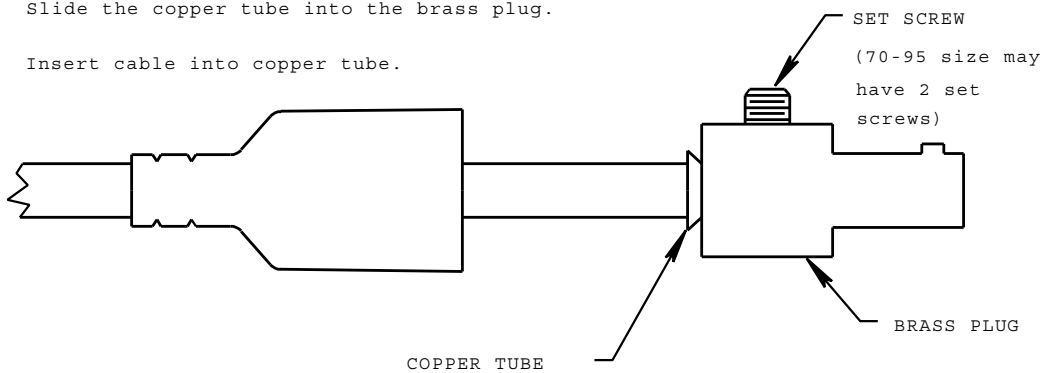

- Tighten set screw(s) to collapse copper tube. Screw(s) must apply firm pressure against welding cable. The top of the set screw(s) will be nearly flush or below the surface of the brass plug after tightening.
- Slide rubber boot over brass plug. The rubber boot must be positioned to completely cover all electrical surfaces after the plug is locked into the receptacle.

 9-20-91J
S18737

CONNECTION OF NON-LINCOLN WIRE FEEDERS

DIAGRAM FOR WIRE FEEDERS THAT CLOSE A SET OF CONTACTS TO GET POWER SOURCE OUTPUT:

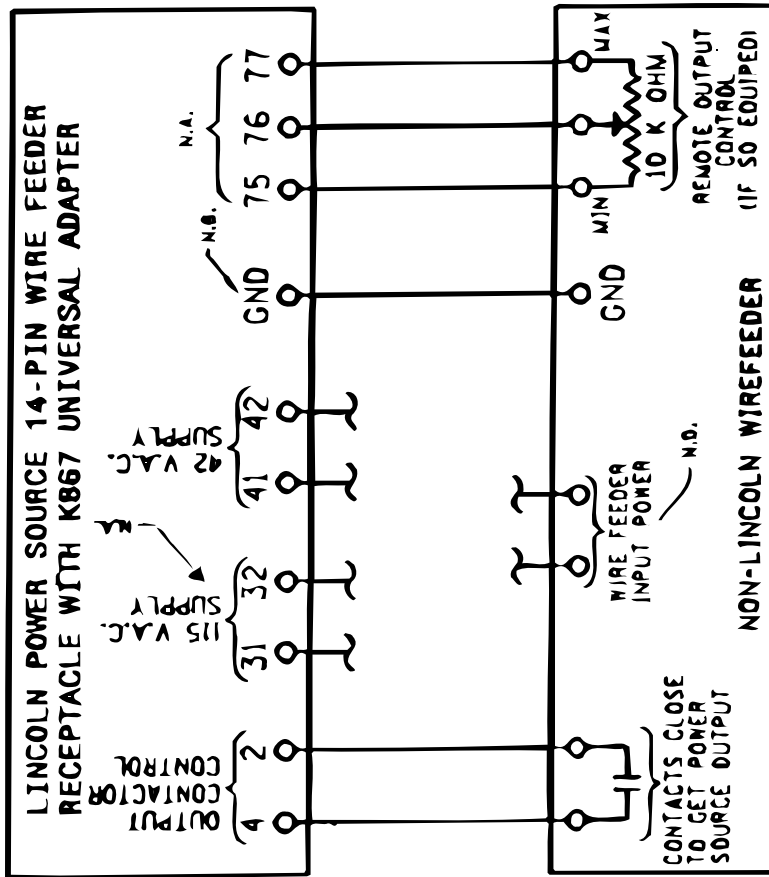
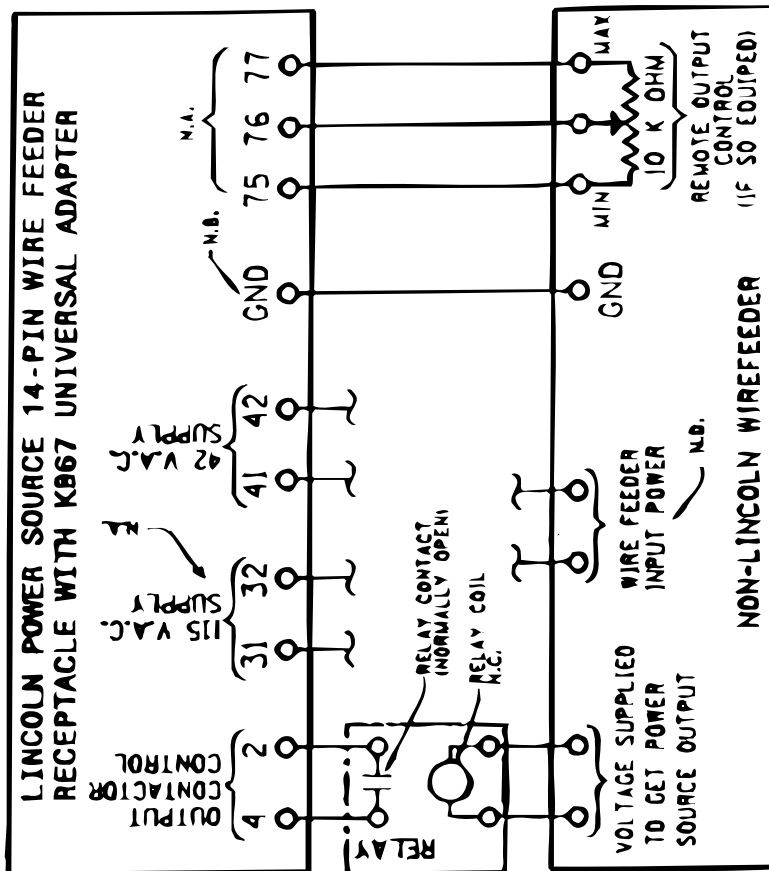
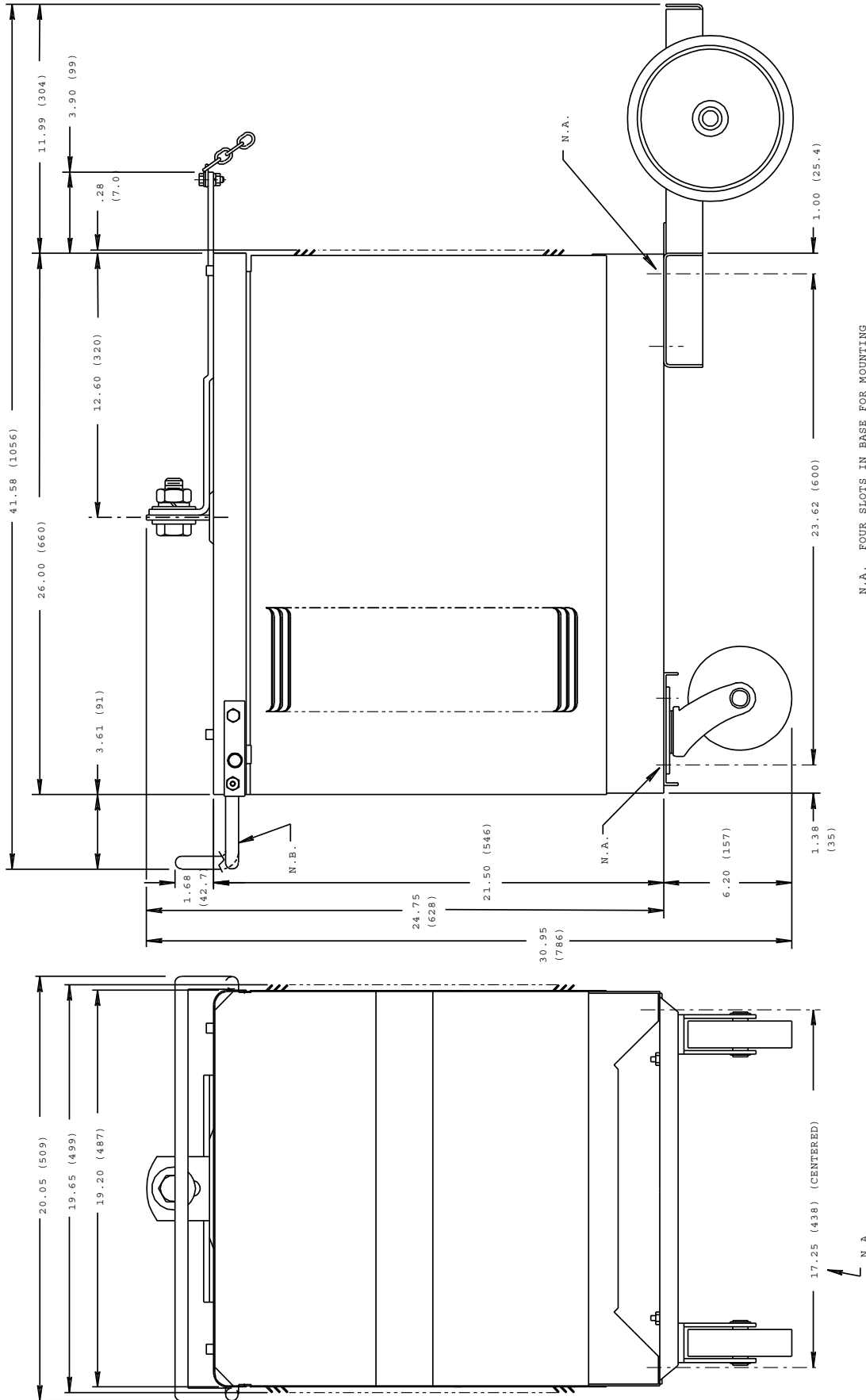

DIAGRAM FOR WIRE FEEDERS THAT SUPPLY A VOLTAGE TO GET POWER SOURCE OUTPUT:



N.A. CONNECTIONS 31 AND 32 MAY NOT BE PRESENT ON ALL MACHINES.
 N.B. POWER SOURCE MUST BE PROPERLY GROUNDED.
 N.C. RELAY COIL MUST BE RATED FOR THE SAME VOLTAGE THAT IS SUPPLIED BY THE WIRE FEEDER.

N.D. IF THE WIRE FEEDER REQUIRES AN INPUT VOLTAGE OTHER THAN 42 V.A.C., OR 115 V.A.C. ON SOME MACHINES, AN EXTERNAL POWER SUPPLY FOR THAT VOLTAGE MUST BE PROVIDED.



WARNING	<ul style="list-style-type: none"> ● Do not touch electrically live parts or electrode with skin or wet clothing. ● Insulate yourself from work and ground. 	<ul style="list-style-type: none"> ● Keep flammable materials away. 	<ul style="list-style-type: none"> ● Wear eye, ear and body protection.
Spanish AVISO DE PRECAUCION	<ul style="list-style-type: none"> ● No toque las partes o los electrodos bajo carga con la piel o ropa mojada. ● Aíslese del trabajo y de la tierra. 	<ul style="list-style-type: none"> ● Mantenga el material combustible fuera del área de trabajo. 	<ul style="list-style-type: none"> ● Protéjase los ojos, los oídos y el cuerpo.
French ATTENTION	<ul style="list-style-type: none"> ● Ne laissez ni la peau ni des vêtements mouillés entrer en contact avec des pièces sous tension. ● Isolez-vous du travail et de la terre. 	<ul style="list-style-type: none"> ● Gardez à l'écart de tout matériel inflammable. 	<ul style="list-style-type: none"> ● Protégez vos yeux, vos oreilles et votre corps.
German WARNUNG	<ul style="list-style-type: none"> ● Berühren Sie keine stromführenden Teile oder Elektroden mit Ihrem Körper oder feuchter Kleidung! ● Isolieren Sie sich von den Elektroden und dem Erdboden! 	<ul style="list-style-type: none"> ● Entfernen Sie brennbares Material! 	<ul style="list-style-type: none"> ● Tragen Sie Augen-, Ohren- und Körperschutz!
Portuguese ATENÇÃO	<ul style="list-style-type: none"> ● Não toque partes elétricas e electrodos com a pele ou roupa molhada. ● Isole-se da peça e terra. 	<ul style="list-style-type: none"> ● Mantenha inflamáveis bem guardados. 	<ul style="list-style-type: none"> ● Use proteção para a vista, ouvido e corpo.
Japanese 注意事項	<ul style="list-style-type: none"> ● 通電中の電気部品、又は溶材にヒフやぬれた布で触れないこと。 ● 施工物やアースから身体が絶縁されている様にして下さい。 	<ul style="list-style-type: none"> ● 燃えやすいものの側での溶接作業は絶対にしてはなりません。 	<ul style="list-style-type: none"> ● 目、耳及び身体に保護具をして下さい。
Chinese 警告	<ul style="list-style-type: none"> ● 皮膚或濕衣物切勿接觸帶電部件及鎢條。 ● 使你自已與地面和工件絕緣。 	<ul style="list-style-type: none"> ● 把一切易燃物品移離工作場所。 	<ul style="list-style-type: none"> ● 佩戴眼、耳及身體勞動保護用具。
Korean 위험	<ul style="list-style-type: none"> ● 전도체나 용접봉을 젖은 헝겊 또는 피부로 절대 접촉치 마십시오. ● 모재와 접지를 접촉치 마십시오. 	<ul style="list-style-type: none"> ● 인화성 물질을 접근시키지 마십시오. 	<ul style="list-style-type: none"> ● 눈, 귀와 몸에 보호장구를 착용하십시오.
Arabic تحذير	<ul style="list-style-type: none"> ● لا تلمس الاجزاء التي يسري فيها التيار الكهربائي أو الألكترود بجسد الجسم أو بالملابس المبللة بالماء. ● ضع عازلا على جسمك خلال العمل. 	<ul style="list-style-type: none"> ● ضع المواد القابلة للاشتعال في مكان بعيد. 	<ul style="list-style-type: none"> ● ضع أدوات وملابس واقية على عينيك وأذنيك وجسمك.

READ AND UNDERSTAND THE MANUFACTURER'S INSTRUCTION FOR THIS EQUIPMENT AND THE CONSUMABLES TO BE USED AND FOLLOW YOUR EMPLOYER'S SAFETY PRACTICES.

SE RECOMIENDA LEER Y ENTENDER LAS INSTRUCCIONES DEL FABRICANTE PARA EL USO DE ESTE EQUIPO Y LOS CONSUMIBLES QUE VA A UTILIZAR, SIGA LAS MEDIDAS DE SEGURIDAD DE SU SUPERVISOR.

LISEZ ET COMPRENEZ LES INSTRUCTIONS DU FABRICANT EN CE QUI REGARDE CET EQUIPMENT ET LES PRODUITS A ETRE EMPLOYES ET SUIVEZ LES PROCEDURES DE SECURITE DE VOTRE EMPLOYEUR.

LESEN SIE UND BEFOLGEN SIE DIE BETRIEBSANLEITUNG DER ANLAGE UND DEN ELEKTRODENEINSATZ DES HERSTELLERS. DIE UNFALLVERHÜTUNGSVORSCHRIFTEN DES ARBEITGEBERS SIND EBENFALLS ZU BEACHTEN.

			
<ul style="list-style-type: none"> ● Keep your head out of fumes. ● Use ventilation or exhaust to remove fumes from breathing zone. 	<ul style="list-style-type: none"> ● Turn power off before servicing. 	<ul style="list-style-type: none"> ● Do not operate with panel open or guards off. 	WARNING
<ul style="list-style-type: none"> ● Los humos fuera de la zona de respiración. ● Mantenga la cabeza fuera de los humos. Utilice ventilación o aspiración para gases. 	<ul style="list-style-type: none"> ● Desconectar el cable de alimentación de poder de la máquina antes de iniciar cualquier servicio. 	<ul style="list-style-type: none"> ● No operar con panel abierto o guardas quitadas. 	Spanish AVISO DE PRECAUCION
<ul style="list-style-type: none"> ● Gardez la tête à l'écart des fumées. ● Utilisez un ventilateur ou un aspirateur pour ôter les fumées des zones de travail. 	<ul style="list-style-type: none"> ● Débranchez le courant avant l'entretien. 	<ul style="list-style-type: none"> ● N'opérez pas avec les panneaux ouverts ou avec les dispositifs de protection enlevés. 	French ATTENTION
<ul style="list-style-type: none"> ● Vermeiden Sie das Einatmen von Schweißrauch! ● Sorgen Sie für gute Be- und Entlüftung des Arbeitsplatzes! 	<ul style="list-style-type: none"> ● Strom vor Wartungsarbeiten abschalten! (Netzstrom völlig öffnen; Maschine anhalten!) 	<ul style="list-style-type: none"> ● Anlage nie ohne Schutzgehäuse oder Innenschutzverkleidung in Betrieb setzen! 	German WARNUNG
<ul style="list-style-type: none"> ● Mantenha seu rosto da fumaça. ● Use ventilação e exaustão para remover fumo da zona respiratória. 	<ul style="list-style-type: none"> ● Não opere com as tampas removidas. ● Desligue a corrente antes de fazer serviço. ● Não toque as partes elétricas nuas. 	<ul style="list-style-type: none"> ● Mantenha-se afastado das partes moventes. ● Não opere com os painéis abertos ou guardas removidas. 	Portuguese ATENÇÃO
<ul style="list-style-type: none"> ● ヒュームから頭を離すようにして下さい。 ● 換気や排煙に十分留意して下さい。 	<ul style="list-style-type: none"> ● メンテナンス・サービスに取りかかる際には、まず電源スイッチを必ず切ってください。 	<ul style="list-style-type: none"> ● パネルやカバーを取り外したまま機械操作をしないで下さい。 	Japanese 注意事項
<ul style="list-style-type: none"> ● 頭部遠離煙霧。 ● 在呼吸區使用通風或排風器除煙。 	<ul style="list-style-type: none"> ● 維修前切斷電源。 	<ul style="list-style-type: none"> ● 儀表板打開或沒有安全罩時不準作業。 	Chinese 警告
<ul style="list-style-type: none"> ● 얼굴로부터 용접가스를 멀리하십시오. ● 호흡지역으로부터 용접가스를 제거하기 위해 가스제거기나 통풍기를 사용하십시오. 	<ul style="list-style-type: none"> ● 보수전에 전원을 차단하십시오. 	<ul style="list-style-type: none"> ● 판넬이 열린 상태로 작동치 마십시오. 	Korean 위험
<ul style="list-style-type: none"> ● ابعد رأسك بعيداً عن الدخان. ● استعمل التهوية أو جهاز ضغط الدخان للخارج لكي تبعد الدخان عن المنطقة التي تتنفس فيها. 	<ul style="list-style-type: none"> ● أقطع التيار الكهربائي قبل القيام بأية صيانة. 	<ul style="list-style-type: none"> ● لا تشغيل هذا الجهاز اذا كانت الاغطية الحديدية الواقية ليست عليه. 	Arabic تحذير

LEIA E COMPREENDA AS INSTRUÇÕES DO FABRICANTE PARA ESTE EQUIPAMENTO E AS PARTES DE USO, E SIGA AS PRÁTICAS DE SEGURANÇA DO EMPREGADOR.

使う機械や溶材のメーカーの指示書をよく読み、まず理解して下さい。そして貴社の安全規定に従って下さい。

請詳細閱讀並理解製造廠提供的說明以及應該使用的銀焊材料，並請遵守貴方的有關於勞動保護規定。

이 제품에 동봉된 작업지침서를 숙지하시고 귀사의 작업자 안전수칙을 준수하시기 바랍니다.

اقرأ بتمعن وافهم تعليمات المصنع المنتج لهذه المعدات والمواد قبل استعمالها واتبع تعليمات الوقاية لصاحب العمل.



• World's Leader in Welding and Cutting Products •

• Sales and Service through Subsidiaries and Distributors Worldwide •

Cleveland, Ohio 44117-1199 U.S.A. TEL: 216.481.8100 FAX: 216.486.1751 WEB SITE: www.lincolnelectric.com