

# Color Monitor

---



## P76

---

Operating Instructions	GB
Mode d'emploi	FR
Bedienungsanleitung	DE
Manual de instrucciones	ES
Istruzioni per l'uso	IT





To avoid shock hazard:

- Do not remove the covers.
- Do not operate this product unless the stand is attached.
- Do not connect or disconnect this product during an electrical storm.
- The power cord plug must be connected to a properly wired and grounded power outlet.
- Any equipment to which this product will be attached must also be connected to properly wired and grounded power outlets.
- To isolate the monitor from the electrical supply, you must remove the plug from the power outlet. The power outlet should be easily accessible.

**Handling:**

- Your color monitor is heavy, so handle it with care. IBM recommends that this monitor is moved or lifted by two people.



Pour éviter les risques d'électrocution :

- Ne retirez pas les capots du moniteur.
- N'utilisez pas ce produit si le socle n'est pas fixé.
- Ne connectez, ni ne déconnectez ce produit pendant un orage.
- Le câble d'alimentation doit être connecté à une prise électrique correctement mise à la terre et en bon état de marche.
- Tout équipement auquel ce produit est relié doit être également connecté à une prise correctement mise à la terre et en bon état de marche.
- Pour isoler le moniteur de la source d'alimentation électrique, vous devez le débrancher de la prise électrique. Cette prise doit être facile d'accès

**Manutention :**

- Votre moniteur couleurs est lourd et doit donc être manipulé avec soin. IBM vous conseille de le déplacer ou de le porter à deux.



Um die Gefahr eines elektrischen Schlags zu vermeiden, folgendes beachten:

- Unter keinen Umständen die Abdeckungen abnehmen.
- Das Produkt nicht in Betrieb nehmen, wenn der Sockel nicht montiert ist.
- Das Gerät nicht während eines Gewitters an eine Steckdose anschließen oder von ihr trennen.
- Das Netzkabel ist an eine ordnungsgemäß verdrahtete und geerdete Steckdose anzuschließen.
- Jedes Gerät, mit dem dieses Produkt verbunden wird, muß ebenfalls an eine ordnungsgemäß verdrahtete und geerdete Steckdose angeschlossen werden.
- Um den Monitor von der Stromversorgung zu trennen, muß der Stecker aus der Steckdose gezogen werden. Die Steckdose sollte leicht zugänglich sein.

**Handhabungshinweis:**

- Ihr Farbbildschirm ist schwer. Sie sollten daher beim Transport vorsichtig vorgehen. IBM empfiehlt Ihnen, den Bildschirm zu zweit anzuheben bzw. zu tragen.



Ga als volgt te werk om het gevaar van een elektrische schok te voorkomen:

- Verwijder in geen enkel geval de kap.
- Stel dit product alleen in werking als de voet is bevestigd.
- Sluit dit apparaat niet aan op, of verbreek de aansluiting van dit apparaat niet van een contactdoos tijdens onweer.
- Het netsnoer moet worden aangesloten op een geaarde contactdoos met correcte bedrading.
- Ook alle apparatuur waarop dit product wordt aangesloten moet zijn aangesloten op een contactdoos met correcte bedrading.
- Om het beeldscherm te ontkoppelen van de netvoeding, dient u de stekker uit de contactdoos te trekken. De contactdoos dient goed toegankelijk te zijn.

**Verplaatsing:**

- Uw kleurenmonitor is zwaar, ga er dus voorzichtig mee om. IBM raadt aan dat het tillen of verplaatsen ervan door twee mensen gebeurt.



Para evitar riesgos de descargas eléctricas:

- No retire bajo ningún concepto las cubiertas.
- No maneje el monitor sin antes acoplar el soporte.
- No conecte ni desconecte el equipo de una toma de alimentación durante una tormenta eléctrica.
- El cable de alimentación debe estar conectado a un enchufe debidamente cableado y con toma de tierra.
- Cualquier equipo al que se vaya a conectar este producto también debe estar conectado a tomas de alimentación cableadas y conectadas a tierra correctamente.
- Para aislar el monitor del suministro eléctrico, debe retirar el enchufe de la toma de alimentación. Esta toma deberá ser de fácil acceso.

**Movimentazione del monitor:**

- Il monitor a colori è pesante, si consiglia quindi di maneggiarlo con attenzione. IBM raccomanda che il monitor venga mosso o sollevato da due persone.

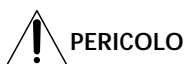

Per evitare il rischio di scariche elettriche:

- Non rimuovere nessuna parte del telaio.
- Non accendere il prodotto se il piedistallo non è stato montato.
- Non collegare o scollegare il prodotto nel corso di un temporale.
- La spina del cavo di alimentazione deve essere collegata ad una presa di corrente con messa a terra, installata in maniera appropriata.
- Le apparecchiature a cui il prodotto viene attaccato devono essere collegate a prese di corrente con messa a terra, installate in maniera appropriata.
- Per isolare il monitor dalla corrente elettrica, staccare la spina dalla presa di alimentazione, che deve essere facilmente accessibile.

**Manipulación:**

- El monitor de color es pesado, por lo que debe manipularlo con cuidado. IBM recomienda moverlo con la ayuda de dos personas.



Para evitar o perigo de choques eléctricos:

- Não retire as coberturas.
- Não utilize este produto antes de montar a base.
- Não ligue nem desligue este produto durante uma tempestade eléctrica.
- O cabo de alimentação deve ser ligado a uma tomada eléctrica devidamente ligada à terra.
- Qualquer equipamento ligado a este produto deve estar ligado a tomadas eléctricas devidamente ligadas à terra.
- Para isolar o monitor da fonte de alimentação, retire a ficha do cabo de alimentação da tomada eléctrica. A tomada eléctrica deve ser de fácil acesso.

**Manuseio:**

- Seu monitor colorido é pesado, então manuseie-o com cuidado. A IBM recomenda que o monitor seja movido ou carregado por duas pessoas.



Sådan undgår du elektrisk stød:

- Kabinettet må under ingen omstændigheder fjernes.
- Undgå at anvende dette produkt, uden at vippe/drejefoden er monteret.
- Undgå at tilslutte eller frakoble dette produkt i tordenvejr.
- Netledningen skal være tilsluttet en korrekt jordet stikkontakt med korrekt ledningsføring.
- Alt udstyr, som tilsluttes dette produkt, skal også være tilsluttet korrekt jordede stikkontakter med korrekt ledningsføring.
- For at isolere skærmen fra strømforsyningen, skal stikket tages ud af stikkontakten. Stikkontakten bør være let tilgængelig.

**Håndtering:**

- Farveskærmen er tung, så den skal håndteres forsigtigt. IBM anbefaler, at skærmen flyttes eller løftes af to personer.



## FARE

Slik unngår du fare for elektrisk støt:

- Ikke ta av dekslene.
- Ikke bruk produktet dersom sokkelen ikke er montert.
- Ikke koble produktet til eller fra under tordenvær.
- Pluggen på strømledningen må kobles til korrekt montert og jordet strømuttak.
- Utstyr som dette produktet eventuelt blir koblet til, må også kobles til korrekt montert og jordet strømuttak.
- For å isolere skjermen fra strømkilden må du ta ut pluggen fra strømuttaket. Strømuttaket bør være lett tilgjengelig.

**Käsittely:**

- Värinäyttö on painava, joten käsittele sitä varoen. IBM suosittelee, että kaksi henkilöä siirtää tai nostaa sitä.



## Varning - livsfara

För att undvika risk för elektriska stötar måste du tänka på följande:

- Ta inte bort några skyddskåpor.
- Använd inte den här produkten innan du har satt fast stativet.
- Anslut inte produkten till ett eluttag under åskväder. Koppla inte heller ur produkten från ett eluttag under åskväder.
- Strömkabeln måste anslutas till ett felfritt och jordat uttag.
- All utrustning som den här produkten kopplas till måste också anslutas till felfria och jordade uttag.
- För att bryta strömmen till bildskärmen måste du dra ut kontakten. Väggtaget bör vara lätt att komma åt.

**Hantering:**

- Färgskärmen är tung och bör därför hanteras försiktigt. IBM rekommenderar att den flyttas eller lyfts av två personer.



## VAARA

Sähköiskun vaaran välttämiseksi:

- Älä avaa laitteen kansia missään tilanteessa.
- Älä käytä laitetta, ellei jalustaa ole kiinnitetty.
- Älä kytke laitetta pistorasiaan tai irrota sitä pistorasiasta ukonilman aikana.
- Virtajohto on kytkettävä asianmukaisesti johdotettuun ja maadoitettuun pistorasiaan.
- Kaikki muutkin laitteet, joihin tämä tuote on liitetty, on kytkettävä asianmukaisesti johdotettuihin pistorasioihin.
- Kun haluat erottaa näyttimen sähköverkosta, sinun pitää irrottaa sen verkkojohto pistorasiasta. Pistorasian pitäisi olla mahdollisimman lähellä näyttintä ja vaivattomasti käsillä.

**Håndtering:**

- Värimonitorinne on painava, joten käsitelkää sitä varovasti. IBM suosittelee, että monitorin siirtämiseen tai kantamiseen käytetään kahta henkilöä.



## ΚΙΝΔΥΝΟΣ

Για την αποφυγή κινδύνου ηλεκτροπληξίας:

- Μην αφαιρείτε τα καλύμματα.
- Μη θέτετε το προϊόν αυτό σε λειτουργία χωρίς να είναι στερεωμένη η βάση του.
- Μη συνδέετε ή αποσυνδέετε το προϊόν αυτό κατά τη διάρκεια ηλεκτροθύελλας.
- Το φως του καλωδίου ρευματολήπτη πρέπει να συνδεθεί σε μια πρίζα με σωστή καλωδίωση και γείωση.
- Κάθε συσκευή στην οποία συνδεθεί αυτό το προϊόν πρέπει επίσης να συνδεθεί σε πρίζα με σωστή καλωδίωση και γείωση.
- Για να απομονώσετε την οθόνη από την παροχή ρεύματος, πρέπει να αφαιρέσετε το φως από την πρίζα. Η πρίζα πρέπει να είναι σε σημείο εύκολα προσβάσιμο.

**Χειρισμός:**

- Η έγχρωμη οθόνη σας είναι βαριά, γι' αυτό χειριστείτε την με προσοχή. Η IBM συνιστά η οθόνη να μεταφέρεται ή να σηκώνεται από δύο άτομα.



Elektrik çarpması tehlikesinden kaçınmak için:

- Kapakları çıkarmayınız.
- Bu cihazı kaidesine takılı durumda değilken çalıştırmayınız.
- Bu cihazı elektriksel fırtına sırasında prize takmayınız veya prizden çıkarmayınız.
- Elektrik kablosunun fişi, elektrik ve toprak bağlantıları usulüne uygun olarak yapılmış bir prize takılmalıdır.
- Bu cihazın bağlanacağı diğer tüm cihazlar da elektrik ve toprak bağlantıları usulüne uygun olarak yapılmış prize takılmış olmalıdır.
- Monitörün elektrikle bağlantısını kesmek için fişini prizden çekmeniz gereklidir. Priz, kolayca erişilebilecek bir yerde olmalıdır.

**Kaldırma:**

- Renkli monitörünüz ağırdır; kaldırırken dikkatli olunuz. IBM, monitörün iki kişi tarafından taşınmasını veya kaldırılmasını tavsiye etmektedir.

# English

# Edition 1

This publication could contain technical inaccuracies or typographical errors. Changes are made periodically to the information herein; these changes will be made in later editions. IBM may make improvements and/or changes in the product(s) and/or program(s) at any time.

It is possible that this publication may contain reference to, or information about, IBM products (machines and programs), programming, or services that are not announced in your country.

Requests for copies of this publication and for technical information about IBM products should be made to your IBM Authorized Dealer or IBM Retailer.

No part of this publication may be reproduced or distributed in any form or by any means without prior permission in writing from the International Business Machines Corporation.

References in this publication to IBM products, programs, or services do not imply that IBM intends to make these available in all countries in which IBM operates. Any reference to an IBM product, program or service is not intended to state or imply that only IBM's product, program, or service may be used. Any functionally equivalent product, program, or service that does not infringe any of IBM's intellectual property rights or other legally protectable rights may be used instead of the IBM product, program, or service. Evaluation and verification of operation in conjunction with other products, programs, or services, except those expressly designated by IBM, are the user's responsibility.

IBM may have patents or pending patent applications covering subject matter in this document. The furnishing of this document does not give you any license to these patents.

## Trademarks

The following terms, used in this publication, are trademarks or service marks of the IBM Corporation in the United States or other countries:

**IBM**

© Copyright International Business Machines Corporation 1999.  
All rights reserved.



# TABLE OF CONTENTS







---

## Getting started

Precautions .....	2
Identifying Parts and Controls .....	3
Setup .....	4

---

## Customizing Your Monitor

Selecting the On-screen Display Language .....	5
Adjusting the Picture Brightness and Contrast .....	5
Introducing the On-screen Display System .....	5
Using the SIZE/CENTER  On-screen Display .....	6
Using the GEOMETRY  On-screen Display .....	7
Using the COLOR  On-screen Display .....	8
Using the CONVERGENCE  On-screen Display .....	9
Using the LANGUAGE  On-screen Display .....	10
Using the OPTION  On-screen Display .....	10
Using the HELP  On-screen Display .....	12
Resetting the Adjustments .....	13

GB

---

## Technical Features

Power Saving Function .....	14
Damper Wires .....	14
Plug & Play .....	14
Preset Modes .....	15
Displaying the Monitor's Information .....	15

---

## Additional Information

Warning Messages .....	15
Troubleshooting .....	16
Self-diagnosis Function .....	18
Specifications .....	18

- ENERGY STAR is a U.S. registered mark.
- Trinitron® is a registered trademark of Sony Corporation.
- VGA is a registered trademark of IBM Corporation of the U.S.A.
- VESA is a trademark of Video Electronics Standard Association.
- All other product names mentioned herein may be the trademarks or registered trademarks of their respective companies.
- Furthermore, "™" and "®" are not mentioned in each case in this manual.

## Precautions

### Installation

- Prevent internal heat build-up by allowing adequate air circulation. Do not place the monitor on surfaces (rugs, blankets, etc.) or near materials (curtains, draperies) that may block the ventilation holes.
- Do not install the monitor near heat sources such as radiators or air ducts, or in a place subject to direct sunlight, excessive dust, mechanical vibration or shock.
- Do not place the monitor near equipment which generates magnetism, such as a transformer or high voltage power lines.

### Maintenance

- Clean the cabinet, panel and controls with a soft cloth lightly moistened with a mild detergent solution. Do not use any type of abrasive pad, scouring powder or solvent, such as alcohol or benzine.
- Do not rub, touch, or tap the surface of the screen with sharp or abrasive items such as a ballpoint pen or screwdriver. This type of contact may result in a scratched picture tube.
- Clean the screen with a soft cloth. If you use a glass cleaning liquid, do not use any type of cleaner containing an anti-static solution or similar additive as this may scratch the screen's coating.

### Transportation

When you transport this monitor for repair or shipment, use the original carton and packing materials.

## Use of the Tilt-Swivel

This monitor can be adjusted within the angles shown below. To find the center of the monitor's turning radius, align the center of the monitor's screen with the centering dots on the stand.

Hold the monitor at the bottom with both hands when you turn it horizontally or vertically. Be careful not to pinch your fingers at the back of the monitor when you tilt the monitor up vertically.

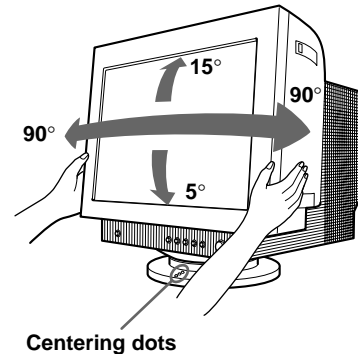

## Warning on power connection

- Use an appropriate power cord for your local power supply.

Examples of plug types:

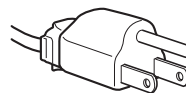

for 100 to 120 V AC

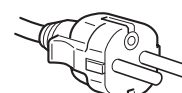

for 200 to 240 V AC

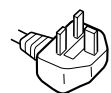

for 240 V AC only

- Before disconnecting the power cord, wait at least 30 seconds after turning off the power to allow the static electricity on the CRT display surface to discharge.
- After the power has been turned on, the CRT is demagnetized (degaussed) for about 5 seconds. This generates a strong magnetic field around the metal frame, which may affect the data stored on magnetic tapes and disks near the bezel. Place magnetic recording equipment, tapes and disks away from this monitor.

The equipment should be installed near an easily accessible electrical outlet.

## Identifying Parts and Controls

See the pages in parentheses for further details.

### Front

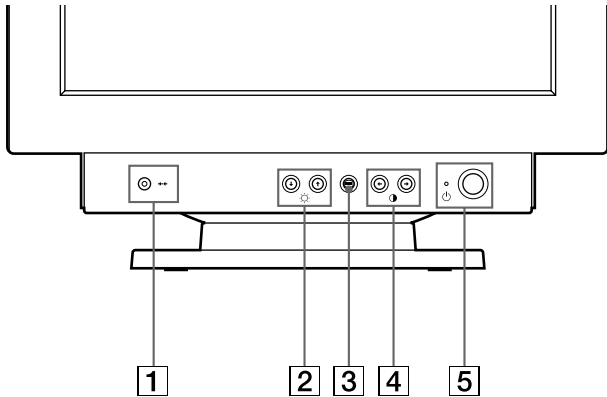

- 1** **(reset) button (page 13)**  
Resets the adjustments to the factory settings.
- 2** **(brightness) down and up (↓/↑) buttons (pages 5 – 13)**  
Adjust the picture brightness.  
  
Function as the (↓/↑) buttons when adjusting other items.
- 3** **button (pages 5 – 13, 15)**  
Displays the MENU OSD.
- 4** **(contrast) left and right (←/→) buttons (pages 5 – 13, 18)**  
Adjust the contrast.  
  
Function as the (←/→) buttons when adjusting other items.
- 5** **(power) switch and indicator (pages 14, 18)**  
Turns the monitor on or off.  
The power indicator lights up in green when the monitor is turned on, and either flashes in green and orange, or lights up in orange when the monitor is in power saving mode.

### Rear

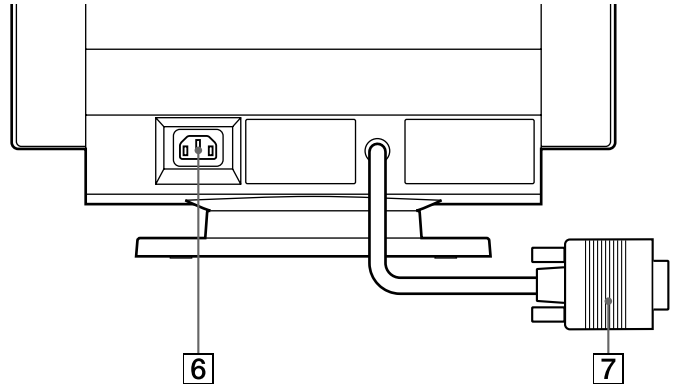

- 6** **AC IN connector (page 4)**  
Provides AC power to the monitor.
- 7** **Video input connector (HD15) (page 4)**  
Inputs RGB video signals (0.700 Vp-p, positive) and SYNC signals.

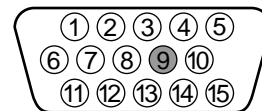

Pin No.	Signal	Pin No.	Signal
1	Red	8	Blue Ground
2	Green (Sync on Green)	9	—
3	Blue	10	Ground
4	ID (Ground)	11	ID (Ground)
5	DDC Ground*	12	Bi-Directional Data (SDA)*
6	Red Ground	13	H. Sync
7	Green Ground	14	V. Sync
		15	Data Clock(SCL)*

\* Display Data Channel (DDC) Standard of VESA

## Setup

This monitor works with platforms running at horizontal frequencies between 30 and 96 kHz.

**Step 1: Make sure the computer and monitor are switched off**

**Step 2: Connect the monitor to the computer**

Connect the video signal cable to the video output of the computer.

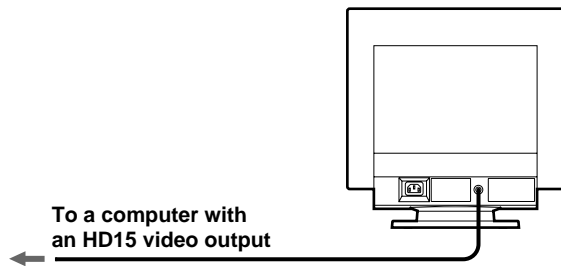

### Note

Do not short the pins of the video signal cable.

**Step 3: Connect the power cord**

With the monitor switched off, connect one end of the proper power cord for your local supply to the monitor and the other end to a power outlet.

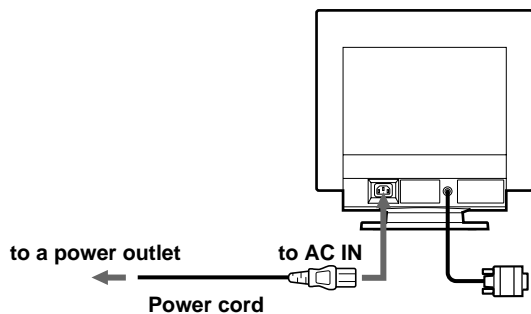

**Step 4: Turn on the monitor and computer**

**Step 5: Adjust the monitor's controls according to your personal preference**

The installation of your monitor is complete.

### Note

If no picture appears on the screen and "MONITOR IS WORKING" or "MONITOR IS IN POWER SAVE MODE" appears on the screen, see "Warning Messages" on page 15.

## Before adjusting

- Connect the monitor and the computer, and turn them on.

## Selecting the On-screen Display Language



If you need to change the OSD language, see “Using the LANGUAGE  On-screen Display” on page 10. The default setting is English.

## Adjusting the Picture Brightness and Contrast



Once the setting is adjusted, it will be stored in memory for all input signals received.

- 1 Press the  (brightness)  or  (contrast)  buttons.  
The BRIGHTNESS/CONTRAST OSD appears.

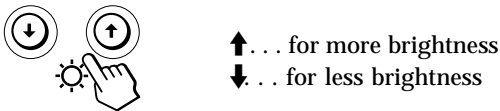

- 2 For brightness adjustment  
Press the   buttons.



- For contrast adjustment  
Press the   buttons.

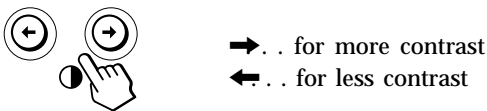

The OSD automatically disappears after about 3 seconds.

To reset, press the  (reset) button while the OSD is on. The brightness and contrast are both reset to the factory settings.





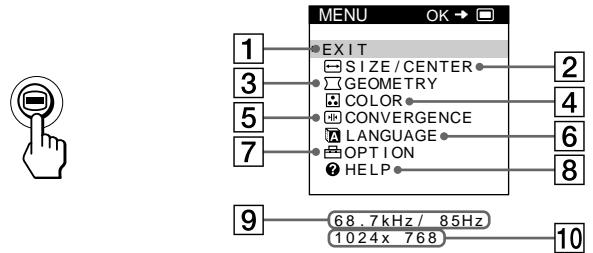

## Introducing the On-screen Display System

Most adjustments are made using the MENU OSD.

### MENU OSD

Press the  button to display the MENU OSD. This MENU OSD contains links to the other OSDs described below.



- 1 **EXIT**  
Closes the MENU OSD.
- 2  **SIZE/CENTER**  
Displays the SIZE/CENTER OSD for adjusting the picture's size, centering or zoom.
- 3  **GEOMETRY**  
Displays the GEOMETRY OSD for adjusting the picture rotation and pincushion, etc.
- 4  **COLOR**  
Displays the COLOR OSD for adjusting the color temperature.
- 5  **CONVERGENCE**  
Displays the CONVERGENCE OSD for adjusting the picture's horizontal and vertical convergence.
- 6  **LANGUAGE**  
Displays the LANGUAGE OSD for selecting the language.
- 7  **OPTION**  
Displays the OPTION OSD for adjusting the OSD position and degaussing the screen, etc.
- 8  **HELP**  
Displays the HELP OSD for viewing helpful hints and information about this monitor.
- 9 **The horizontal and vertical frequencies of the current input signal**  
The horizontal and vertical frequencies of the current input signal are displayed.
- 10 **The resolution of the current input signal**  
If the signal matches one of this monitor's factory preset modes, the resolution is displayed.



## Using the SIZE/CENTER On-screen Display

The SIZE/CENTER settings allow you to adjust the picture's size, centering or zoom.

Once the setting is adjusted, it will be stored in memory for the current input signal.

- 1 Press the  button.  
The MENU OSD appears.





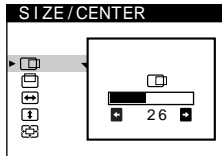
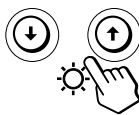

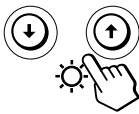

- 2 Press the  buttons to select "SIZE/CENTER," and press the  button again.  
The SIZE/CENTER OSD appears.









- 3 Press the  buttons to select the item you want to adjust.

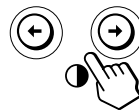



Select	To
 (Horizontal Centering)	adjust the horizontal centering of the picture
 (Vertical Centering)	adjust the vertical centering of the picture
 (Horizontal Sizing)	adjust the horizontal size of the picture
 (Vertical Sizing)	adjust the vertical size of the picture
 (Zoom)	enlarge and reduce the picture

- 4 Press the  buttons to adjust the settings.



Select	To
 (Horizontal Centering)	→ ... to move the picture right ← ... to move the picture left
 (Vertical Centering)	→ ... to move the picture up ← ... to move the picture down
 (Horizontal Sizing)	→ ... to increase picture width ← ... to decrease picture width
 (Vertical Sizing)	→ ... to increase picture height ← ... to decrease picture height
 (Zoom)	→ ... to enlarge the picture ← ... to reduce the picture

Press the  button once to return to the MENU OSD, and twice to return to normal viewing. If no buttons are pressed, the OSD closes automatically after about 30 seconds.

To reset, press the  (reset) button while the OSD is on. The selected item is reset to the factory setting.

### Notes

The  (Zoom) adjustment stops when the horizontal or vertical size reaches its maximum or minimum value. The horizontal adjustment value is not displayed in the menu.



## Using the GEOMETRY On-screen Display

The GEOMETRY settings allow you to adjust the shape and orientation of the picture.



Once the (Rotation) is adjusted, it will be stored in memory for all input signals received. All other adjustments will be stored in memory for the current input signal.

- 1 Press the  button.  
The MENU OSD appears.



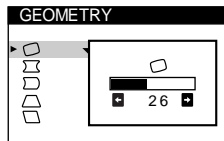
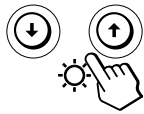



- 2 Press the   buttons to select "GEOMETRY," and press the  button again.  
The GEOMETRY OSD appears.

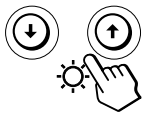









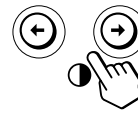







- 3 Press the   buttons to select the item you want to adjust.





Select	To
 (Rotation)	adjust the picture rotation
 (Pincushion)	adjust the picture sides
 (Pin Balance)	adjust the picture side balance
 (Keystone)	adjust the picture width
 (Key Balance)	adjust the picture shape balance

- 4 Press the  buttons to adjust the settings.



For	Press
 (Rotation)	 ... to rotate the picture clockwise  ... to rotate the picture counterclockwise
 (Pincushion)	 ... to expand the picture sides  ... to contract the picture sides
 (Pin Balance)	 ... to move the picture sides to the right  ... to move the picture sides to the left
 (Keystone)	 ... to increase the picture width at the top  ... to decrease the picture width at the top
 (Key Balance)	 ... to move the top of the picture to the right  ... to move the top of the picture to the left

Press the  button once to return to the MENU OSD, and twice to return to normal viewing. If no buttons are pressed, the OSD closes automatically after about 30 seconds.



To reset, press the  (reset) button while the OSD is on. The selected item is reset to the factory setting.

## Using the COLOR On-screen Display

You can change the monitor's color temperature. For example, you can adjust or change the colors of a picture on the screen to match the actual colors of the printed picture. Once the setting is adjusted, it will be stored in memory for all input signals received.

- 1 Press the  button.  
The MENU OSD appears.



- 2 Press the  buttons to select "COLOR," and press the  button again.  
The COLOR OSD appears.

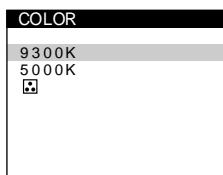
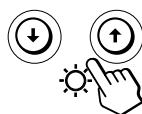

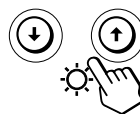

- 3 Press the  buttons to select the color temperature.





There are two color temperature modes in the OSD. The preset adjustments are 9,300K and 5,000K.

Selecting your own color temperature between 9,300K and 5,000K

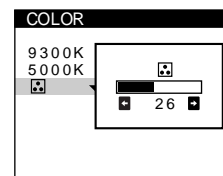
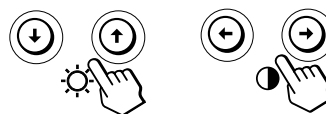
Press the  buttons to select "Variable" and adjust by pressing the  buttons.



 for a higher temperature (bluish)  
 for a lower temperature (reddish)

Press the  button once to return to the MENU OSD, and twice to return to normal viewing. If no buttons are pressed, the OSD closes automatically after about 30 seconds.

To reset, press the  (reset) button while the OSD is on. The selected color temperature is reset to the factory settings.





## Using the CONVERGENCE On-screen Display



The CONVERGENCE settings allow you to adjust the quality of the picture by controlling the convergence. The convergence refers to the alignment of the red, green, and blue color signals. If you see red or blue shadows around letters or lines, adjust the convergence. Once the setting is adjusted, it will be stored in memory for all input signals received.

- 1 Press the  button.  
The MENU OSD appears.



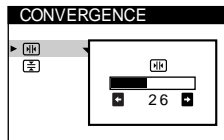
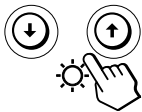

- 2 Press the / buttons to select "CONVERGENCE," and press the  button again.  
The CONVERGENCE OSD appears.



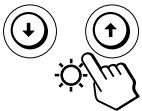





- 3 Press the / buttons to select the item you want to adjust.

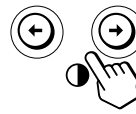



Select	To
 (Horizontal Convergence)	adjust the horizontal convergence
 (Vertical Convergence)	adjust the vertical convergence

- 4 Press the / buttons to adjust the settings.



For	Press
 (Horizontal Convergence)	<p> ... to shift red shadows to the right and blue shadows to the left</p> <p> ... to shift red shadows to the left and blue shadows to the right</p>
 (Vertical Convergence)	<p> ... to shift red shadows up and blue shadows down</p> <p> ... to shift red shadows down and blue shadows up</p>

Press the  button once to return to the MENU OSD, and twice to return to normal viewing. If no buttons are pressed, the OSD closes automatically after about 30 seconds.



To reset, press the  (reset) button while the OSD is on. The selected item is reset to the factory setting.

## Using the LANGUAGE On-screen Display

English, French, German, Spanish, Italian, Dutch, Swedish, Russian and Japanese versions of the OSDs are available.

- 1 Press the  button.  
The MENU OSD appears.



- 2 Press the  buttons to select "LANGUAGE," and press the  button again.  
The LANGUAGE OSD appears.

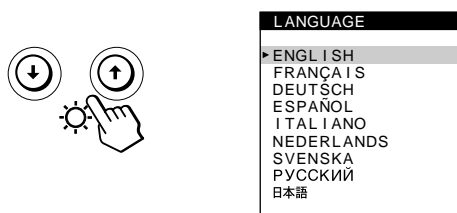

- 3 Press the  buttons to select the desired language.

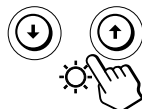

- ENGLISH
- FRANÇAIS: French
- DEUTSCH: German
- ESPAÑOL: Spanish
- ITALIANO: Italian
- NEDERLANDS: Dutch
- SVENSKA: Swedish
- РУССКИЙ: Russian
- 日本語: Japanese

Press the  button once to return to the MENU OSD, and twice to return to normal viewing. If no buttons are pressed, the OSD closes automatically after about 30 seconds.

To reset to English, press the  (reset) button while the OSD is on.

## Using the OPTION On-screen Display



The OPTION OSD allows you to manually degauss the screen, adjust the moire cancellation level, and adjust the OSD position. It also allows you to lock the controls.

### Degaussing the screen

The monitor screen is automatically degaussed (demagnetized) when the power is turned on. You can also manually degauss the monitor.

- 1 Press the  button.  
The MENU OSD appears.



- 2 Press the  buttons to select "OPTION," and press the  button again.  
The OPTION OSD appears.

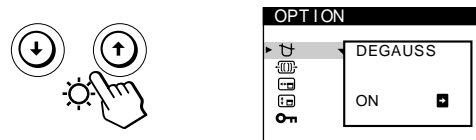

- 3 Press the  buttons to select "DEGAUSS."

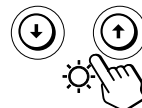

- 4 Press the  button.  
The screen is degaussed for about 5 seconds.

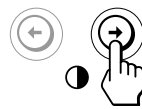

If you need to degauss the screen a second time, wait for at least 20 minutes before repeating the steps above.



Press the  button once to return to the MENU OSD, and twice to return to normal viewing. If no buttons are pressed, the OSD closes automatically after about 30 seconds.

## Adjusting the moire



If elliptical or wavy patterns appear on the screen, adjust the moire cancellation level.

- 1 Press the  button.  
The MENU OSD appears.



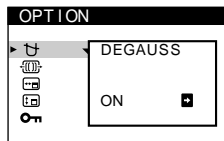
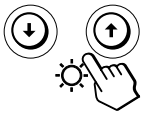

- 2 Press the / buttons to select "OPTION" and press the  button again.  
The OPTION OSD appears.

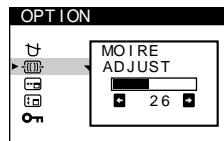
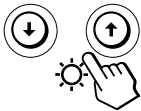

- 3 Press the / buttons to select "MOIRE\* ADJUST."



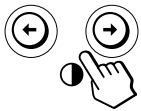

- 4 Press the / buttons to adjust the amount of moire cancellation until the moire effect is at a minimum.

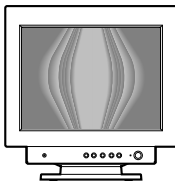

\* Moire is a type of natural interference which produces soft, wavy lines on your screen. It may appear due to interference between the pattern of the picture on the screen and the phosphor pitch pattern of the monitor.

Example of moire:



Press the  button once to return to the MENU OSD, and twice to return to normal viewing. If no buttons are pressed, the OSD closes automatically after about 30 seconds.



To reset, press the  (reset) button while the OSD is on.

## Changing the on-screen display position



You can change the OSD position (for example, when you want to adjust the picture behind the OSD).

- 1 Press the  button.  
The MENU OSD appears.

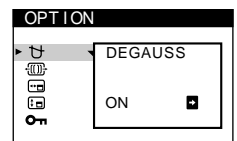
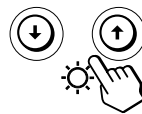

- 2 Press the / buttons to select "OPTION," and press the  button again.  
The OPTION OSD appears.



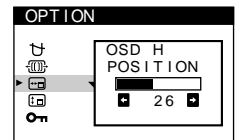
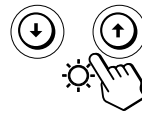

- 3 Press the / buttons to select "(OSD H POSITION)" or "(OSD V POSITION)."  
Select "(OSD H POSITION)" to adjust the horizontal position.



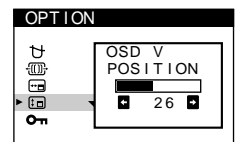
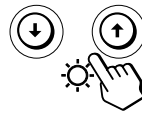

Select "(OSD V POSITION)" to adjust the vertical position.

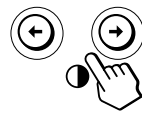

- 4 Press the / buttons to move the OSD to the desired position.



Press the  button once to return to the MENU OSD, and twice to return to normal viewing. If no buttons are pressed, the OSD closes automatically after about 30 seconds.





To reset, press the  (reset) button while the OSD is on.

## Locking the controls



You can protect adjustment data by locking the controls.

- 1 Press the  button.  
The MENU OSD appears.

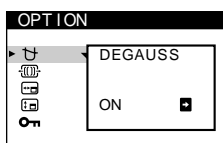
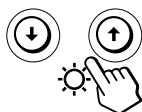

- 2 Press the / buttons to select " OPTION," and press the  button again.  
The OPTION OSD appears.





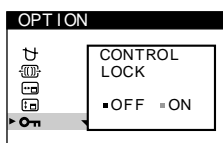
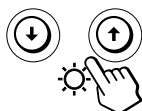

- 3 Press the / buttons to select " (CONTROL LOCK)."



- 4 Press the  button to select "ON."



Press the  button once to return to the MENU OSD, and twice to return to normal viewing. If no buttons are pressed, the OSD closes automatically after about 30 seconds.

Only the  (power) switch, EXIT, and " (CONTROL LOCK)" of the " OPTION" OSD will operate. If any other items are selected, the  mark appears on the screen.

### To cancel the control lock





Repeat steps 1 through 3 above and press the  button to select "OFF."

## Using the HELP On-screen Display



The HELP OSD contains helpful hints and information about this monitor. If your monitor is displaying symptoms that match those listed in the HELP OSD, follow the on-screen instructions to resolve the problem. If the symptoms do not match those listed in the HELP OSD or if the problem persists, see "Troubleshooting" on page 16.

- 1 Press the  button.  
The MENU OSD appears.

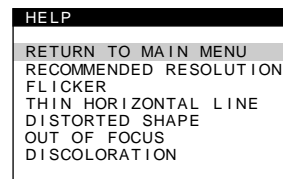
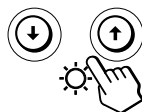

- 2 Press the / buttons to select " HELP" and press the  button again.  
The HELP OSD appears.



- 3 Press the / buttons to select a HELP menu item and press the  button again.  
Instructions or information to resolve the problem appears on the screen. An explanation of each menu item is given below.

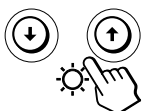

### RECOMMENDED RESOLUTION

If the picture does not fill the screen to the edges or if the picture appears too large for the screen, adjust the resolution to the figures shown in the OSD using your computer. If the input signal matches one of this monitor's factory preset modes, the resolution and refresh rate of the current input signal are displayed.

### FLICKER

If the picture is flickering, adjust the refresh rate to figures shown in the OSD. If the input signal matches one of this monitor's factory preset modes, the refresh rate of the current input signal is displayed.

### THIN HORIZONTAL LINE

The lines that appear on your screen are damper wires. See page 13 for more information about the damper wires.

## DISTORTED SHAPE

If the shape of the picture on the screen seems distorted, try adjusting the picture's geometry. Press the **→** button to jump directly to the GEOMETRY OSD.

## OUT OF FOCUS

The picture may seem to be out of focus when the red and blue color signals are not aligned properly, causing red or blue shadows to appear around letters and lines. Try adjusting the picture's convergence to make the shadows disappear. Press the **→** button to jump directly to the CONVERGENCE OSD. When the CONVERGENCE OSD is displayed, the contrast, brightness and moire adjustment settings are automatically reset for all input signals.

## DISCOLORATION

If the picture's color appears abnormal in certain areas of the screen, first check for any loose signal cables. After you have checked the cables, try degaussing (demagnetizing) the screen manually. Press the **→** button to jump directly to the OPTION OSD, then select **⌘** (DEGAUSS).

Press the **⏪** button once to return to the MENU OSD, and twice to return to normal viewing. If no buttons are pressed, the OSD closes automatically after about 30 seconds.

## Resetting the Adjustments

### Resetting an adjustment item

- 1 Press the **⏪**, **↓/↑** buttons to select the OSD containing the item you want to reset.



- 2 Press the **↓/↑** buttons to select the item you want to reset.

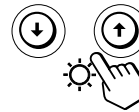

- 3 Press the **↔** (reset) button.

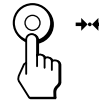

### Resetting all of the adjustment data for the current input signal

When there is no OSD displayed, press the **↔** (reset) button.

All of the adjustments data for the current input signal is reset to the factory settings.

Note that adjustment data not affected by changes in input signal (OSD language, OSD position and the control lock function) is not reset to the factory settings.

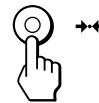

### Resetting all of the adjustment data for all input signals

Press and hold the **↔** (reset) button for more than two seconds.

All of the adjustment data, including the brightness and contrast, is reset to the factory settings.

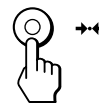

#### Note

The **↔** (reset) button does not function when **⏻** (CONTROL LOCK) is set to ON.

## Power Saving Function

This monitor meets the power-saving guidelines set by VESA and Energy Star, as well as the more stringent NUTEK .

If the monitor is connected to a computer or video graphics board that is VESA DPMS (Display Power Management Signaling) compliant, the monitor will automatically reduce power consumption in three stages as shown below.

	Power consumption mode	Screen	Horizontal sync signal	Vertical sync signal	Power consumption	Recovery time	⏻ indicator
1	Normal operation	active	present	present	≤ 130 W	—	Green
2	Standby (1st mode)	blank	absent	present	≤ 15 W	Approx. 5 sec.	Green and orange alternate
3	Suspend (2nd mode)	blank	present	absent	≤ 15 W	Approx. 5 sec.	Green and orange alternate
4	Active-off (3rd mode)	blank	absent	absent	≤ 3 W	Approx. 15 sec.	Orange
5	Power-off	—	—	—	0 W	—	Off

### Note

When your computer is in a power saving mode, MONITOR IS IN POWER SAVE MODE appears on the screen if you press any button on the monitor (page 15). After a few seconds, the monitor enters the power saving mode again. Once the horizontal and vertical sync signals are detected, the monitor automatically resumes its normal operation mode.

## Damper Wires

When viewing a white background, very thin horizontal lines may be visible on the screen as shown below. These lines are the shadows of the damper wires and are characteristic of CRTs that use aperture grilles. The wires are attached to the aperture grille on the inside of the Trinitron tube and prevent the vibration of the aperture grille.

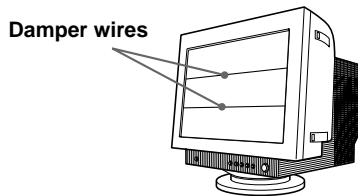

## Plug & Play

This monitor complies with the DDC™1, DDC2B and DDC2Bi Display Data Channel (DDC) standards of VESA. When a DDC1 host system is connected, the monitor synchronizes with the V. CLK in accordance with the VESA standards and outputs the EDID (Extended Display Identification Data) to the data line. When a DDC2B or DDC2Bi host system is connected, the monitor automatically switches to the appropriate standard.

DDC™ is a trademark of the Video Electronics Standard Association.

### Preset Modes

No.	Resolution (dots × lines)	Horizontal Frequency	Vertical Frequency	Graphics Mode
1	640 × 480	31.5 kHz	60 Hz	VGA
2	640 × 480	37.5 kHz	75 Hz	VESA
3	640 × 480	43.3 kHz	85 Hz	VESA
4	800 × 600	46.9 kHz	75 Hz	VESA
5	800 × 600	53.7 kHz	85 Hz	VESA
6	1024 × 768	60.0 kHz	75 Hz	VESA
7	1024 × 768	68.7 kHz	85 Hz	VESA
8	1280 × 1024	80.0 kHz	75 Hz	VESA

### Displaying the Monitor's Information

You can display the model name, serial number and year of manufacture using the monitor's INFORMATION OSD.

Press and hold the  button for 5 seconds.  
The INFORMATION OSD appears.

**Example:**



I N F O R M A T I O N	
MODEL :	IBM P76
SER NO :	12 - 34567
MANUFACTURED :	1999 - 52

The INFORMATION OSD includes the model name, serial number and manufactured year.

The OSD automatically disappears after about 30 seconds.

### Warning Messages

If no pictures appears on the screen, one of the following messages appears on the screen.

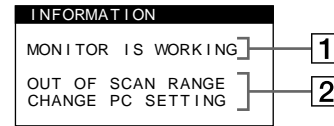

If **MONITOR IS WORKING** appears on the screen

**1 The monitor's condition**  
**MONITOR IS WORKING**

This indicates that the monitor is working properly.

**2 The input signal condition and the remedies**  
**CHECK SIGNAL CABLE**

This indicates that no signal is input. Check that the video signal cable is properly connected and all plugs are firmly seated in their sockets.

**OUT OF SCAN RANGE and CHANGE PC SETTING**

These indicate that the input signal is not supported by the monitor's specifications. Check that the video frequency range is within that specified for the monitor. (Horizontal: 30 – 96 kHz, Vertical: 48 – 120 Hz)

**GB**

If **MONITOR IS IN POWER SAVE MODE** appears on the screen

**1 The monitor's condition**  
**MONITOR IS IN POWER SAVE MODE**

This indicates that the computer is in power saving mode. This message is displayed only when your computer is in a power saving mode and you press any one of the buttons on the monitor.





**2 The remedies**  
**ACTIVATE USING PC**

Try pressing any key on the computer, and confirm that your computer's graphic board is completely seated in the correct bus slot.

For more information, see "Troubleshooting" on page 16.

## Troubleshooting

This section may help you isolate the cause of a problem and as a result, eliminate the need to contact technical support.

Symptom	Check these items
<b>No picture</b>	
If the  indicator is not lit	<ul style="list-style-type: none"> <li>• Check that the power cord is properly connected.</li> <li>• Check that the  (power) switch is in the “on” position.</li> </ul>
If the “CHECK SIGNAL CABLE” message appears on the screen, or if the  indicator is either orange or alternating between green and orange	<ul style="list-style-type: none"> <li>• Check that your computer power switch is in the “on” position.</li> <li>• Check that the video signal cable is properly connected and all plugs are firmly seated in their sockets.</li> <li>• Ensure that no pins are bent or pushed in the HD15 video input connector.</li> <li>• Check that the graphic board is completely seated in the proper bus slot.</li> </ul>
If the “MONITOR IS IN POWER SAVE MODE” message appears on the screen, or if the  indicator is either orange or alternating between green and orange	<ul style="list-style-type: none"> <li>• The computer is in power saving mode. Try pressing any key on the computer keyboard.</li> <li>• Check that your computer power switch is in the “on” position.</li> <li>• Check that the graphic board is completely seated in the proper bus slot.</li> </ul>
If the “OUT OF SCAN RANGE” message appears on the screen	<ul style="list-style-type: none"> <li>• Check that the video frequency range is within that specified for the monitor. (Horizontal: 30 – 96 kHz, Vertical: 48 – 120 Hz) Refer to your computer’s instruction manual to adjust the video frequency range.</li> <li>• If you are using a video signal cable adapter, check that it is the correct one.</li> </ul>
If no message is displayed and the  indicator is green or flashing orange	<ul style="list-style-type: none"> <li>• See “Self-diagnosis Function” (page 18).</li> </ul>
<b>Picture is scrambled</b>	<ul style="list-style-type: none"> <li>• Check your graphics board manual for the proper monitor setting.</li> <li>• Check this manual and confirm that the graphics mode and the frequency you are trying to operate at is supported. Even if the frequency is within the proper range, some graphic boards may have a sync pulse that is too narrow for the monitor to sync correctly.</li> </ul>
<b>Color is not uniform</b>	<ul style="list-style-type: none"> <li>• Degauss the monitor (page 10). If you place equipment which generates a magnetic field, such as a loudspeaker, near the monitor, or you change the direction of the monitor, color may lose uniformity. The degauss function demagnetizes the metal frame of the CRT to obtain a neutral field for uniform color reproduction. If a second degauss cycle is needed, allow a minimum interval of 20 minutes for the best result.</li> </ul>
<b>You cannot adjust the monitor with the buttons on the front panel</b>	<ul style="list-style-type: none"> <li>• If the control lock function is set to ON, set it to OFF using the OPTION OSD (page 12).</li> </ul>



<b>Symptom</b>	<b>Check these items</b>
Screen image is not centered or sized properly	<ul style="list-style-type: none"> <li>Adjust the size or centering (page 6). Some video modes do not fill the screen to the edges. This problem tends to occur with certain graphic boards.</li> </ul>
Edges of the image are curved	<ul style="list-style-type: none"> <li>Adjust the geometry (page 7).</li> </ul>
White lines show red or blue shadows at edges	<ul style="list-style-type: none"> <li>Adjust the convergence (page 9).</li> </ul>
Picture is fuzzy	<ul style="list-style-type: none"> <li>Adjust the contrast and brightness (page 4).</li> <li>Degauss the monitor (page 10). If you place equipment which generates a magnetic field, such as a loudspeaker, near the monitor, or you change the direction of the monitor, color may lose uniformity. The degauss function demagnetizes the metal frame of the CRT to obtain a neutral field for uniform color reproduction. If a second degauss cycle is needed, allow a minimum interval of 20 minutes for the best result.</li> <li>If red or blue shadows appear along the edges of images, adjust the convergence (page 9).</li> <li>Select MOIRE ADJUST and adjust the moire cancellation effect (page 11).</li> </ul>
Picture bounces or has wavy oscillations	<ul style="list-style-type: none"> <li>Isolate and eliminate any potential sources of electric or magnetic fields. Common causes for this symptom are electric fans, fluorescent lighting or laser printers.</li> <li>If you have another monitor close to this monitor, increase the distance between them to reduce the interference.</li> <li>Try plugging the monitor into a different AC outlet, preferably on a different circuit.</li> <li>Try the monitor on a different computer in a different room.</li> </ul>
Picture is flickering	<ul style="list-style-type: none"> <li>Set the refresh rate on the computer to obtain the best possible picture by referring to your computer's manual.</li> </ul>
Picture appears to be ghosting	<ul style="list-style-type: none"> <li>Eliminate the use of video cable extensions and/or video switch boxes if this symptom occurs. Excessive cable length or a weak connection can produce this symptom.</li> </ul>
Wavy or elliptical (moire) pattern is visible	<ul style="list-style-type: none"> <li>Select MOIRE ADJUST and adjust the moire cancellation effect (page 11). The moire may be modified depending on the connected computer.</li> <li>Due to the relationship between resolution, monitor dot pitch and the pitch of some image patterns, certain screen backgrounds sometimes show moire. Change your desktop pattern.</li> </ul>
Two fine horizontal lines (wires) are visible	<ul style="list-style-type: none"> <li>These wires stabilize the vertically striped aperture grille (page 14). This aperture grille allows more light to pass through to the screen giving the Trinitron CRT more color and brightness.</li> </ul>
Hum is heard right after the power is turned on	<ul style="list-style-type: none"> <li>When the power is turned on, the auto-degauss cycle is activated. While the auto-degauss cycle is activated, a hum may be heard. The same hum is heard when the monitor is manually degaussed. This is not a malfunction.</li> </ul>

**GB**



- If the problem persists, call you service representative from a location near your monitor.
- Note the model name and the serial number of your monitor. Also note the make and name of your computer and graphic board.

### Self-diagnosis Function

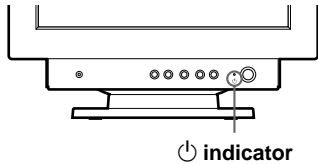
This monitor is equipped with a self-diagnosis function. If there is a problem with your monitor or computer, the screen will go blank and the  indicator will either light up green or flash orange.



#### If the indicator is green

- 1 Disconnect the video input cable or turn off the connected computer.
- 2 Press the  button twice to turn the monitor off and then on.
- 3 Press and hold the  button for 2 seconds before the monitor enters power saving mode.

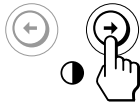



If all four color bars appear (white, red, green, blue), the monitor is working properly. Reconnect the video input cable and check the condition of your computer.

If the color bars do not appear, there is a potential monitor failure. Inform your service representative of the monitor's condition.

#### If the indicator is flashing orange

Press the  button twice to turn the monitor off and then on.

If the  indicator lights up green, the monitor is working properly.

If the  indicator is still flashing, there is a potential monitor failure. Inform your service representative of the monitor's condition. Be sure to note the model name and serial number of your monitor. Also note the make and model of your computer and video board.

### Specifications

Picture tube	0.24 mm aperture grille pitch 17 inches measured diagonally 90-degree deflection
Viewable image size	Approx. 327 × 243 mm (w/h) (12 <sup>7</sup> / <sub>8</sub> × 9 <sup>5</sup> / <sub>8</sub> inches) 16.0" viewable diagonal
Resolution	Horizontal: Max. 1600 dots Vertical: Max. 1200 lines
Standard image area	Approx. 312 × 234 mm (w/h) (12 <sup>3</sup> / <sub>8</sub> × 9 <sup>1</sup> / <sub>4</sub> inches)
Deflection frequency	Horizontal: 30 to 94 kHz Vertical: 48 to 120 Hz 256 < Total Line < 1700
AC input voltage/current	100 to 240 V, 50/60 Hz, Max. 1.7 A
Power consumption	Max. 130 W
Dimensions	Approx. 404 × 413.5 × 419.5 mm (w/h/d) (16 × 16 <sup>3</sup> / <sub>8</sub> × 16 <sup>5</sup> / <sub>8</sub> inches)
Mass	Approx. 20 kg (44 lb 1 oz)

- \* Recommended horizontal and vertical timing condition
- Horizontal sync width should be more than 1.0 μsec.
  - Horizontal blanking width should be more than 3.0 μsec.
  - Vertical blanking width should be more than 500 μsec.

Design and specifications are subject to change without notice.

## Federal Communications Commission (FCC) Statement

This equipment has been tested and found to comply with the limits for a Class B digital device, pursuant to Part 15 of the FCC Rules. These limits are designed to provide reasonable protection against harmful interference in a residential installation. This equipment generates, uses, and can radiate radio frequency energy and, if not installed and used in accordance with the instructions, may cause harmful interference to radio communications. However, there is no guarantee that interference will not occur in a particular installation.

If this equipment does cause harmful interference to radio or television reception, which can be determined by turning the equipment off and on, the user is encouraged to try to correct the interference by one or more of the following measures:

- Reorientate or relocate the receiving antenna.
- Increase the separation between the equipment and receiver.
- Connect the equipment into an outlet on a circuit different from that to which the receiver is connected.
- Consult an IBM authorized dealer or service representative for help.

Properly shielded and grounded cables and connectors must be used in order to meet FCC emission limits. Proper cables and connectors are available from IBM authorized dealers. IBM is not responsible for any radio or television interference caused by using other than recommended cables and connectors or by unauthorized changes or modifications to this equipment. Unauthorized changes or modifications could void the user's authority to operate the equipment.

### Declaration of Conformity

Trade name:	IBM Corporation
Model No.:	6556-03N
Responsible Party:	Sony Electronics Inc.
Address:	1 Sony Drive, Park Ridge, NJ. 07656
Telephone No.:	201-930-6972

This Device complies with Part 15 of the FCC Rules. Operation is subject to the following two conditions: (1) This device may not cause harmful interference, and (2) this device must accept any interference received, including interference that may cause undesired operation.

## Power Cords

For your safety, IBM provides a power cord with a grounded attachment plug to use with this IBM product. To avoid electrical shock, always use the power cord and plug with a properly grounded power outlet.

IBM power cords used in the United States and Canada are listed by the Underwriters Laboratories (UL) and certified by the Canadian Standards Association (CSA).

For units intended to be operated at 115 volts: Use a UL listed and CSA certified cord set consisting of a minimum 18 AWG, type SVT or SJT, three conductor cord, a maximum of 4.5 metres (15 feet) in length and a parallel blade, grounding type attachment plug rated 15 amperes, 125 volts.

For units intended to be operated at 230 volts (U.S. use): Use a UL listed and CSA certified cord set consisting of a minimum 18 AWG, type SVT or SJT, three conductor cord, a maximum of 4.5 metres (15 feet) in length and a tandem blade, grounding type attachment plug rated 15 amperes 250 volts.

For units intended to be operated at 230 volts (outside the U.S.): Use a cord set with a grounding type attachment plug rated 13 amperes (minimum), 250 volts. The cord set should be marked <HAR> and have the appropriate safety approvals for the country in which the equipment will be installed.



As an ENERGY STAR Partner, IBM Corporation has determined that this product meets the ENERGY STAR guidelines for energy efficiency.

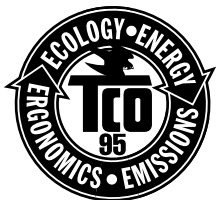

This monitor complies with TCO'95 guidelines.



This monitor complies with TCO'99 guidelines.

この装置は、情報処理装置等電波障害自主規制協議会(VCCI)の基準に基づくクラスB情報技術装置です。この装置は、家庭環境で使用することを目的としていますが、この装置がラジオやテレビジョン受信機に近接して使用されると、受信障害を引き起こすことがあります。

取扱説明書に従って正しい取り扱いをしてください。

## **MPRII**

This product complies with Swedish National Council for Metrology (MPR) standards issued in December 1990 (MPRII) for very low frequency (VLF) and extremely low frequency (ELF).

## **Hinweise**

Gemäß der Amtsblätter des BMPT Nm. 61/1991 und 6/1992 wird der Betreiber darauf aufmerksam gemacht, daß die von ihm mit diesem Gerät zusammengestellte Anlage auch den technischen Bestimmungen dieser Amtsblätter genügen muß.

Aus ergonomischen Gründen wird empfohlen, die Grundfarbe Blau nicht auf dunklem Untergrund zu verwenden (schlechte Erkennbarkeit, Augenbelastung bei zu geringem Zeichenkontrast).

Aus ergonomischen Gründen sollten nur Darstellungen auf dunklem Hintergrund bei Vertikalfrequenzen ab 60 Hz (ohne Zeilensprung) benutzt werden.

Die Konvergenz des Bildes kann sich auf Grund des Magnetfeldes am Ort der Aufstellung aus der korrekten Grundeinstellung verändern. Zur Korrektur empfiehlt es sich deshalb, die Regler an der Frontseite für H STAT und V STAT so einzustellen, daß die getrennt sichtbaren Farblinien für Rot, Grün und Blau bei z.B. der Darstellung eines Buchstabens zur Deckung (Konvergenz) gelangen. Siehe hierzu auch die Erklärungen zu H STAT und V STAT.

## **NOM**

IBM de México, S.A.

IBM P76 Monitor de Color (M/T 6556)

Planta de Manufactura

6 Aza-Ikejiri, Oaza-Takada,

Ichinomiya-shi, Aichi-ken,

492 Japan

Hecho en Japón

**NOM - 018**

Consumo de Corriente 1.7A

Frecuencia de Operacion 50/60 Hz

Rension de Alimentacion 100 - 240 V

## **Industry Canada Compliance Statement**

This Class B digital apparatus meets the requirements of the Canadian Interference-Causing Equipment Regulations.

Cet appareil numérique de la classe B respecte toutes les exigences du Règlement sur le matériel brouilleur du Canada.

## European Union (EU) Statement

This product has been tested and found to comply with the limits for Class B Information Technology Equipment according to CISPR 22 / European Standard EN 55022. The limits for Class B equipment were derived for typical residential environments to provide reasonable protection against interference with licensed communication devices.

Properly shielded and grounded cables and connectors must be used in order to reduce the potential for causing interference to radio and TV communications and to other electrical or electronic equipment. Such cables and connectors are available from IBM authorised dealers.

In accordance with EN 50082-1 1992, Performance Criterion A., it should be noted that in the presence of certain electromagnetic fields, some screen jitter may be observed.

## Spécifications de la CEE

Ce produit a été testé et déclaré conforme aux limites de la Classe B définies pour les équipements informatiques conformément à la norme européenne CISPR 22/EN 55022. Les limites imposées aux équipements de Classe B visent à garantir une protection raisonnable, dans des environnements résidentiels, contre toute interférence avec des équipements de communication agréés.

Des câbles blindés et correctement reliés à la terre doivent être utilisés pour réduire les risques d'interférence avec des communications radio et télévisées, ainsi qu'avec des équipements électriques ou électroniques. Ces câbles et connecteurs sont disponibles auprès de vos revendeurs IBM agréés.

Conformément à la norme EN 50082-1 1992, Performance Criterion A, veuillez noter qu'en présence de certains champs électromagnétiques l'image de l'écran peut être instable.

## Erklärung für die Europäische Union (EU)

Dieses Produkt wurde getestet, und dabei wurde festgestellt, daß es gemäß CISPR 22 / Europäische Norm EN 55022 die Grenzwerte für Ausrüstung der Informationstechnik, Klasse B, einhält. Die Grenzwerte für Ausrüstung der Klasse B wurden für eine typische Wohnumgebung erarbeitet, um einen angemessenen Schutz vor Störungen im Zusammenhang mit zugelassenen Kommunikationsgeräten zu gewährleisten.

Es sind ordnungsgemäß abgeschirmte und geerdete Kabel und Stecker zu verwenden, um das Störungspotential in bezug auf Radio- und Fernsehempfang oder andere elektrische oder elektronische Geräte zu reduzieren. Solche Kabel und Stecker sind bei autorisierten IBM-Fachhändlern erhältlich.

In Übereinstimmung mit EN 50082-1 1992, Leistungskriterium A wird darauf hingewiesen, daß bestimmte elektromagnetische Felder ein Flattern auf dem Bildschirm hervorrufen können.

## Declaración de la Unión Europea (UE)

Este producto ha sido probado y cumple con las limitaciones estipuladas para la Clase B ITE (Information Technology Equipment), de conformidad con CISPR 22 / Estándar Europeo EN 55022. Las limitaciones de los equipos de Clase B se establecieron para que los entornos residenciales típicos a fin de proporcionar una protección razonable contra interferencias con dispositivos de comunicación autorizados.

Se deben utilizar conectores y cables debidamente protegidos y conectados a tierra a fin de reducir las posibilidades de que se produzcan interferencias con comunicaciones por radio o televisión y otros equipos eléctricos o electrónicos. Este tipo de cables y conectores pueden adquirirse en concesionarios autorizados de IBM.

De acuerdo con la norma EN 50082-1 1992, Performance Criterion A, habría que destacar que en presencia de determinados campos electromagnéticos, podría observarse una marcada inestabilidad e la imagen.

## Dichiarazione di conformità dell'Unione Europea (UE)

Questo prodotto è stato collaudato e trovato conforme ai limiti di Classe B relativi agli apparecchi informatici secondo quanto dispone la normativa europea CISPR 22 / EN 55022. I limiti degli apparecchi di Classe B sono stati definiti per i normali ambienti domestici al fine di fornire un'adeguata protezione con dispositivi di comunicazione autorizzati.

Utilizzare cavi e connettori collegati a terra per ridurre il rischio potenziale di interferenza delle comunicazioni radiotelevisive e di altri apparecchi elettrici o elettronici. I cavi sono disponibili presso i rivenditori autorizzati IBM.

In accordo con quanto previsto nel documento EN 50082-1 1992, Performance Criterion A, è importante sottolineare che in presenza di determinati campi elettromagnetici è possibile che si verifichi un certo tremolio delle immagini.

## Statement of Limited Warranty U.S., Canada and Puerto Rico

The warranties provided by IBM in this Statement of Limited Warranty apply only to Machines you originally purchase for your use, and not for resale, from IBM or your reseller. The term "Machine" means an IBM machine, its features, conversions, upgrades, elements, or accessories, or any combination of them. Unless IBM specifies otherwise, the following warranties apply only in the country where you acquire the Machine. If you have any questions, contact IBM or your reseller.

Machine: P76 M/T 6556  
Warranty Period\*: 3 years.  
\* Contact your place of purchase for warranty service information

### Production Status

Each Machine is manufactured from new parts, or new and used parts. In some cases, the Machine may not be new and may have been previously installed. Regardless of the Machine's production status, IBM's warranty terms apply.

### The IBM Warranty for Machines

IBM warrants that each Machine 1) is free from defects in materials and workmanship and 2) conforms to IBM's Official Published Specifications. The warranty period for a Machine is a specified, fixed period commencing on its Date of Installation. The date on your receipt is the Date of Installation, unless IBM or your reseller informs you otherwise. During the warranty period IBM or your reseller, if authorized by IBM, will provide warranty service under the type of service designated for the Machine and will manage and install engineering changes that apply to the Machine.

For IBM or your reseller to provide warranty service for a feature, conversion, or upgrade, IBM or your reseller may require that the Machine on which it is installed be 1) for certain Machines, the designated, serial-numbered Machine and 2) at an engineering-change level compatible with the feature, conversion, or upgrade. Many of these transactions involve the removal of parts and their return to IBM. You represent that all removed parts are genuine and unaltered. A part that replaces a removed part will assume the warranty service status of the replaced part.

If a Machine does not function as warranted during the warranty period, IBM or your reseller will repair it or replace it with one that is at least functionally equivalent, without charge. The replacement may not be new, but will be in good working order. If IBM or your reseller is unable to repair or replace the Machine, you may return it to your place of purchase and your money will be refunded.

If you transfer a Machine to another user, warranty service is available to that user for the remainder of the warranty period. You should give your proof of purchase and this Statement to that user. However, for Machines which have a life-time warranty, this warranty is not transferable.

### Warranty Service

To obtain warranty service for the Machine, you should contact your reseller or call IBM. In the United States, call IBM at 1-800-772-2227. In Canada, call IBM at 1-800-565-3344. You may be required to present proof of purchase.

IBM or your reseller will provide certain types of repair and exchange service, either at your location or at IBM's or your reseller's service center, to restore a Machine to good working order.

When a type of service involves the exchange of a Machine or part, the item IBM or your reseller replaces becomes its property and the replacement becomes yours. You represent that all removed items are genuine and unaltered. The replacement may not be new, but will be in good working order and at least functionally equivalent to the item replaced. The replacement assumes the warranty service status of the replaced item. Before IBM or your reseller exchanges a Machine or part, you agree to remove all features, parts, options, alterations, and attachments not under warranty service. You also agree to ensure that the Machine is free of any legal obligations or restrictions that prevent its exchange.

You agree to:

1. obtain authorization from the owner to have IBM or your reseller service a Machine that you do not own; and
2. where applicable, before service is provided -
  - a) follow the problem determination, problem analysis, and service request procedures that IBM or your reseller provide,
  - b) secure all programs, data, and funds contained in a Machine, and
  - c) inform IBM or your reseller of changes in a Machine's location.

IBM is responsible for loss of, or damage to, your Machine while it is 1) in IBM's possession or 2) in transit in those cases where IBM is responsible for the transportation charges.

## **Extent of Warranty**

IBM does not warrant uninterrupted or error-free operation of a Machine.

The warranties may be voided by misuse, accident, modification, unsuitable physical or operating environment, improper maintenance by you, removal or alteration of Machine or parts identification labels, or failure caused by a product for which IBM is not responsible.

THESE WARRANTIES REPLACE ALL OTHER WARRANTIES OR CONDITIONS, EXPRESS OR IMPLIED, INCLUDING, BUT NOT LIMITED TO, THE IMPLIED WARRANTIES OR CONDITIONS OF MERCHANTABILITY AND FITNESS FOR A PARTICULAR PURPOSE. THESE WARRANTIES GIVE YOU SPECIFIC LEGAL RIGHTS AND YOU MAY ALSO HAVE OTHER RIGHTS WHICH VARY FROM JURISDICTION TO JURISDICTION. SOME JURISDICTIONS DO NOT ALLOW THE EXCLUSION OR LIMITATION OF EXPRESS OR IMPLIED WARRANTIES, SO THE ABOVE EXCLUSION OR LIMITATION MAY NOT APPLY TO YOU. IN THAT EVENT SUCH WARRANTIES ARE LIMITED IN DURATION TO THE WARRANTY PERIOD. NO WARRANTIES APPLY AFTER THAT PERIOD.

## **Limitation of Liability**

Circumstances may arise where, because of a default on IBM's part or other liability you are entitled to recover damages from IBM. In each such instance, regardless of the basis on which you are entitled to claim damages from IBM (including fundamental breach, negligence, misrepresentation, or other contract or tort claim), IBM is liable only for:

1. damages for bodily injury (including death) and damage to real property and tangible personal property; and 2. the amount of any other actual direct damages or loss, up to the greater of U.S. \$100,000 or the charges (if recurring, 12 months' charges apply) for the Machine that is the subject of the claim.

UNDER NO CIRCUMSTANCES IS IBM LIABLE FOR ANY OF THE FOLLOWING: 1) THIRD-PARTY CLAIMS AGAINST YOU FOR LOSSES OR DAMAGES (OTHER THAN THOSE UNDER THE FIRST ITEM LISTED ABOVE); 2) LOSS OF, OR DAMAGE TO, YOUR RECORDS OR DATA; OR 3) SPECIAL, INCIDENTAL, OR INDIRECT DAMAGES OR FOR ANY ECONOMIC CONSEQUENTIAL DAMAGES (INCLUDING LOST PROFITS OR SAVINGS), EVEN IF IBM OR YOUR RESELLER IS INFORMED OF THEIR POSSIBILITY. SOME JURISDICTIONS DO NOT ALLOW THE EXCLUSION OR LIMITATION OF INCIDENTAL OR CONSEQUENTIAL DAMAGES, SO THE ABOVE EXCLUSION OR LIMITATION MAY NOT APPLY TO YOU.

## **Statement of Limited Warranty, Europe.**

For European warranty terms and conditions refer to enclosed IBM warranty statement Part Number 72H9623.

Référez-vous à la garantie IBM N° de référence 72H9623 pour les conditions de garantie européennes.

Die europäischen Garantiebedingungen finden Sie in der beigegeführten IBM- Gewährleistungserklärung, Teilenummer 72H9623.

Los términos y condiciones de las garantías en Europa se recogen en la declaración de garantía adjunta del número de pieza IBM 72H9623.

Per le condizioni e i termini di garanzia relativi ai paesi europei, consultare l'apposita dichiarazione IBM (numero di matricola 72H9623).

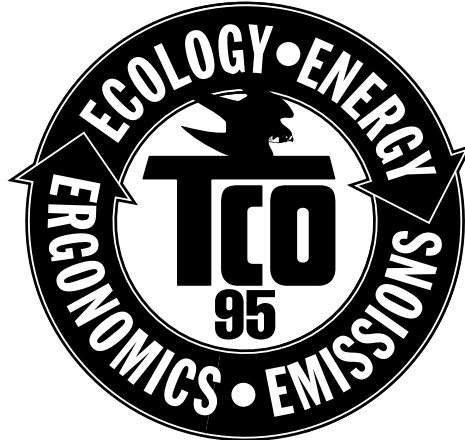

## **Congratulations!**

---

You have just purchased a TCO'95 approved and labelled product! Your choice has provided you with a product developed for professional use. Your purchase has also contributed to reducing the burden on the environment and also, to the further development of environmentally adapted electronics products.

## **Why do we have environmentally labelled computers?**

---

In many countries, environmental labelling has become an established method for encouraging the adaptation of goods and services to the environment. The main problem, as far as computers and other electronics equipment are concerned, is that environmentally harmful substances are used both in the products and during the manufacturing. Since it has not been possible for the majority of electronics equipment to be recycled in a satisfactory way, most of these potentially damaging substances sooner or later enter Nature.

There are also other characteristics of a computer, such as energy consumption levels, that are important from the viewpoints of both the work (internal) and natural (external) environments. Since all methods of conventional electricity generation have a negative effect on the environment (acidic and climate-influencing emissions, radioactive waste, etc.), it is vital to conserve energy. Electronics equipment in offices consume an enormous amount of energy since they are often left running continuously.

## **What does labelling involve?**

---

This product meets the requirements for the TCO'95 scheme which provides for international and environmental labelling of personal computers. The labelling scheme was developed as a joint effort by the TCO (The Swedish Confederation of Professional Employees), Naturskyddsforeningen (The Swedish Society for Nature Conservation) and NUTEK (The National Board for Industrial and Technical Development in Sweden).

The requirements cover a wide range of issues: environment, ergonomics, usability, emission of electrical and magnetic fields, energy consumption and electrical and fire safety.

The environmental demands concern restrictions on the presence and use of heavy metals, brominated and chlorinated flame retardants, CFCs (freons) and chlorinated solvents, among other things. The product must be prepared for recycling and the manufacturer is obliged to have an environmental plan which must be adhered to in each country where the company implements its operational policy.

The energy requirements include a demand that the computer and/or display, after a certain period of inactivity, shall reduce its power consumption to a lower level in one or more stages. The length of time to reactivate the computer shall be reasonable for the user.

Labelled products must meet strict environmental demands, for example, in respect of the reduction of electric and magnetic fields, physical and visual ergonomics and good usability.



On this page, you will find a brief summary of the environmental requirements met by this product. The complete environmental criteria document may be ordered from:

TCO Development Unit

S-114 94 Stockholm

Sweden

Fax: +46 8 782 92 07

Email (Internet): [development@tco.se](mailto:development@tco.se)

Current information regarding TCO'95 approved and labelled products may also be obtained via the Internet, using the address:

<http://www.tco-info.com/>

TCO'95 is a co-operative project between TCO (The Swedish Confederation of Professional Employees), Naturskyddsforeningen (The Swedish Society for Nature Conservation) and NUTEK (The National Board for Industrial and Technical Development in Sweden).

## Environmental Requirements

---

### Brominated flame retardants

Brominated flame retardants are present in printed circuit boards, cables, wires, casings and housings. In turn, they delay the spread of fire. Up to thirty percent of the plastic in a computer casing can consist of flame retardant substances. These are related to another group of environmental toxins, PCBs, which are suspected to give rise to similar harm, including reproductive damage in fish-eating birds and mammals, due to the bio-accumulative\* processes. Flame retardants have been found in human blood and researchers fear that disturbances in foetus development may occur.

TCO'95 demand requires that plastic components weighing more than 25 grams must not contain organically bound chlorine and bromine.

### Lead\*\*

Lead can be found in picture tubes, display screens, solders and capacitors. Lead damages the nervous system and in higher doses, causes lead poisoning.

TCO'95 requirement permits the inclusion of lead since no replacement has yet been developed.

### Cadmium\*\*

Cadmium is present in rechargeable batteries and in the colour-generating layers of certain computer displays. Cadmium damages the nervous system and is toxic in high doses.

TCO'95 requirement states that batteries may not contain more than 25 ppm (parts per million) of cadmium. The colour-generating layers of display screens must not contain any cadmium.

### Mercury\*\*

Mercury is sometimes found in batteries, relays and switches. Mercury damages the nervous system and is toxic in high doses. TCO'95 requirement states that batteries may not contain more than 25 ppm (parts per million) of mercury. It also demands that no mercury is present in any of the electrical or electronics components concerned with the display unit.

### CFCs (freons)

CFCs (freons) are sometimes used for washing printed circuit boards and in the manufacturing of expanded foam for packaging. CFCs break down ozone and thereby damage the ozone layer in the stratosphere, causing increased reception on Earth of ultraviolet light with consequent increased risks of skin cancer (malignant melanoma).

The relevant TCO'95 requirement: Neither CFCs nor HCFCs may be used during the manufacturing of the product or its packaging.

\* Bio-accumulative is defined as substances which accumulate within living organisms

\*\* Lead, Cadmium and Mercury are heavy metals which are Bio-accumulative.

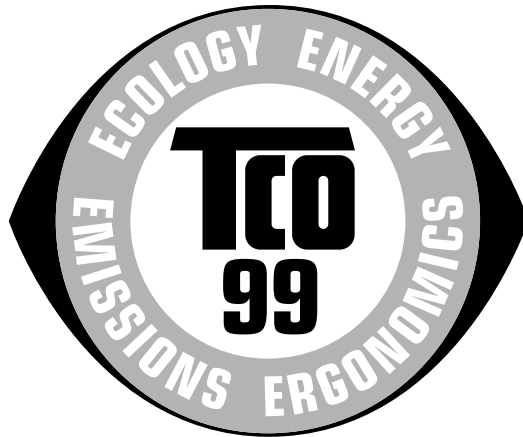

## **Congratulations!**

---

You have just purchased a TCO'99 approved and labelled product! Your choice has provided you with a product developed for professional use. Your purchase has also contributed to reducing the burden on the environment and also to the further development of environmentally adapted electronics products.

## **Why do we have environmentally labelled computers?**

---

In many countries, environmental labelling has become an established method for encouraging the adaptation of goods and services to the environment. The main problem, as far as computers and other electronics equipment are concerned, is that environmentally harmful substances are used both in the products and during their manufacture. Since it is not so far possible to satisfactorily recycle the majority of electronics equipment, most of these potentially damaging substances sooner or later enter nature.

There are also other characteristics of a computer, such as energy consumption levels, that are important from the viewpoints of both the work (internal) and natural (external) environments. Since all methods of electricity generation have a negative effect on the environment (e.g. acidic and climate-influencing emissions, radioactive waste), it is vital to save energy. Electronics equipment in offices is often left running continuously and thereby consumes a lot of energy.

## **What does labelling involve?**

---

This product meets the requirements for the TCO'99 scheme which provides for international and environmental labelling of personal computers. The labelling scheme was developed as a joint effort by the TCO (The Swedish Confederation of Professional Employees), Svenska Naturskyddsforeningen (The Swedish Society for Nature Conservation) and Statens Energimyndighet (The Swedish National Energy Administration).

Approval requirements cover a wide range of issues: environment, ergonomics, usability, emission of electric and magnetic fields, energy consumption and electrical and fire safety.

The environmental demands impose restrictions on the presence and use of heavy metals, brominated and chlorinated flame retardants, CFCs (freons) and chlorinated solvents, among other things. The product must be prepared for recycling and the manufacturer is obliged to have an environmental policy which must be adhered to in each country where the company implements its operational policy.

The energy requirements include a demand that the computer and/or display, after a certain period of inactivity, shall reduce its power consumption to a lower level in one or more stages. The length of time to reactivate the computer shall be reasonable for the user.

Labelled products must meet strict environmental demands, for example, in respect of the reduction of electric and magnetic fields, physical and visual ergonomics and good usability.

Below you will find a brief summary of the environmental requirements met by this product. The complete environmental criteria document may be ordered from:

**TCO Development**

SE-114 94 Stockholm, Sweden

Fax: +46 8 782 92 07

Email (Internet): [development@tco.se](mailto:development@tco.se)

Current information regarding TCO'99 approved and labelled products may also be obtained via the Internet, using the address: <http://www.tco-info.com/>

## Environmental requirements

---

### Flame retardants

Flame retardants are present in printed circuit boards, cables, wires, casings and housings. Their purpose is to prevent, or at least to delay the spread of fire. Up to 30% of the plastic in a computer casing can consist of flame retardant substances. Most flame retardants contain bromine or chloride, and those flame retardants are chemically related to another group of environmental toxins, PCBs. Both the flame retardants containing bromine or chloride and the PCBs are suspected of giving rise to severe health effects, including reproductive damage in fish-eating birds and mammals, due to the bio-accumulative\* processes. Flame retardants have been found in human blood and researchers fear that disturbances in foetus development may occur.

The relevant TCO'99 demand requires that plastic components weighing more than 25 grams must not contain flame retardants with organically bound bromine or chlorine. Flame retardants are allowed in the printed circuit boards since no substitutes are available.

### Cadmium\*\*

Cadmium is present in rechargeable batteries and in the colour-generating layers of certain computer displays. Cadmium damages the nervous system and is toxic in high doses. The relevant TCO'99 requirement states that batteries, the colour-generating layers of display screens and the electrical or electronics components must not contain any cadmium.

### Mercury\*\*

Mercury is sometimes found in batteries, relays and switches. It damages the nervous system and is toxic in high doses. The relevant TCO'99 requirement states that batteries may not contain any mercury. It also demands that mercury is not present in any of the electrical or electronics components associated with the labelled unit.

### CFCs (freons)

The relevant TCO'99 requirement states that neither CFCs nor HCFCs may be used during the manufacture and assembly of the product. CFCs (freons) are sometimes used for washing printed circuit boards. CFCs break down ozone and thereby damage the ozone layer in the stratosphere, causing increased reception on earth of ultraviolet light with e.g. increased risks of skin cancer (malignant melanoma) as a consequence.

### Lead\*\*

Lead can be found in picture tubes, display screens, solders and capacitors. Lead damages the nervous system and in higher doses, causes lead poisoning. The relevant TCO'99 requirement permits the inclusion of lead since no replacement has yet been developed.

\* Bio-accumulative is defined as substances which accumulate within living organisms.

\*\* Lead, Cadmium and Mercury are heavy metals which are Bio-accumulative.

## Service Information

The following parts are for use by IBM service, or IBM authorized dealers, to support customer warranty. Parts are for service use only.

Part No	M/T-Model	Description
21L4572	6556-03N	Monitor UVNH (Pearl White), NA/EMEA
21L4573	6556-43N	Monitor UVNH (Stealth Gray), NA/EMEA
61H0213	6556-03N	Monitor UVSH (Pearl White)
61H0214	6556-43N	Monitor UVSH (Stealth Gray)
61H0215	6556-03S	Video Cable (Pearl White)
61H0216	6556-43S	Video Cable (Stealth Gray)



P202 User Guide Part Number 61H0239  
EC D03285

