

# INSTALLATION INSTRUCTIONS FOR SELF-CONTAINED PACKAGE AIR CONDITIONERS AND HEAT PUMP UNITS GPC/GPH 13 SEER "M" SERIES WITH R-410A

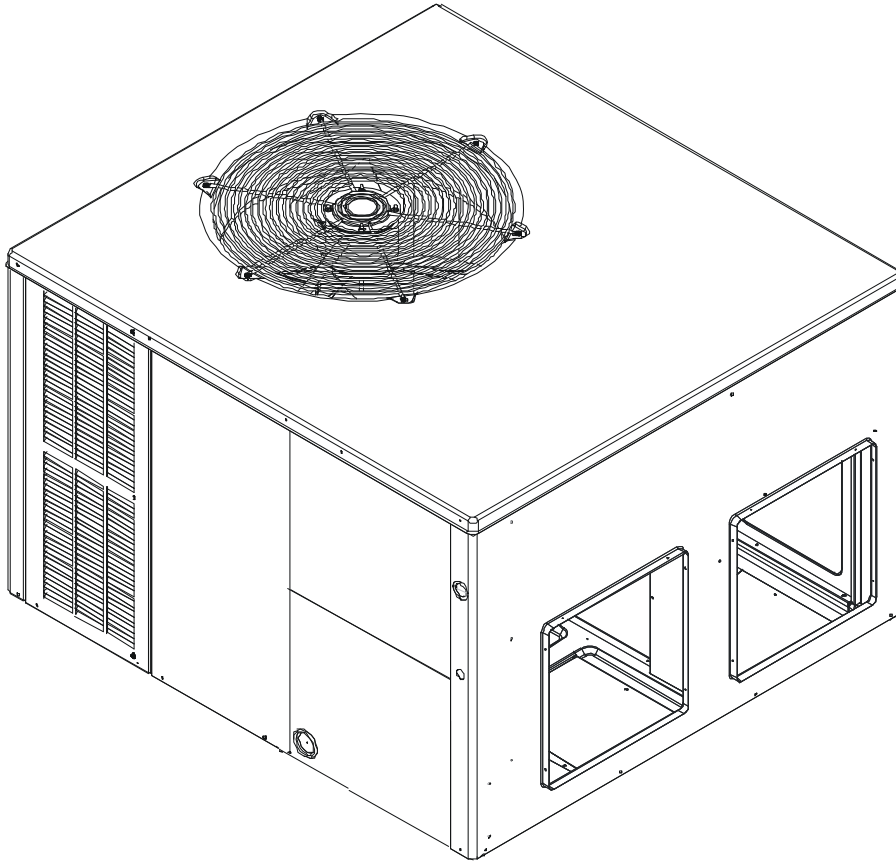

 **RECOGNIZE THIS SYMBOL AS A SAFETY PRECAUTION.**

## ATTENTION INSTALLING PERSONNEL

Prior to installation, thoroughly familiarize yourself with this Installation Manual. Observe all safety warnings. During installation or repair, caution is to be observed.

It is your responsibility to install the product safely and to educate the customer on its safe use.

These installation instructions cover the **outdoor** installation of self contained package air conditioners and heating units. See the Specification Sheets applicable to your model for information regarding accessories.

\*NOTE: Please contact your distributor or our website for the applicable Specification Sheets referred to in this manual.



## INDEX

To THE INSTALLER .....	2
To THE OWNER .....	2
<b>SHIPPING INSPECTION</b> .....	<b>3</b>
<b>REPLACEMENT PARTS</b> .....	<b>3</b>
ORDERING PARTS .....	3
<b>SAFETY INSTRUCTIONS</b> .....	<b>3</b>
<b>CODES AND REGULATIONS</b> .....	<b>3</b>
EPA REGULATIONS .....	4
NATIONAL CODES .....	4
<b>MAJOR COMPONENTS</b> .....	<b>4</b>
<b>PRE-INSTALLATION CHECKS</b> .....	<b>4</b>
CLEARANCES AND ACCESSIBILITY .....	4
UNIT LOCATION .....	4
GROUND LEVEL PRE-INSTALLATION DETAILS .....	4
ROOF TOP PRE-INSTALLATION DETAILS .....	4
ROOF CURB INSTALLATIONS ONLY .....	5
RIGGING DETAILS .....	5
<b>CIRCULATING AIR AND FILTERS</b> .....	<b>5</b>
AIRFLOW CONVERSION .....	5
DUCT WORK .....	6
FILTERS .....	6
<b>PIPING</b> .....	<b>6</b>
CONDENSATE DRAIN .....	6
<b>WIRING</b> .....	<b>7</b>
HIGH VOLTAGE WIRING .....	7
LOW VOLTAGE WIRING .....	7
INTERNAL WIRING .....	7
<b>STARTUP, ADJUSTMENTS, AND CHECKS</b> .....	<b>8</b>
START-UP PROCEDURE AND CHECKLIST .....	8
HEAT PUMP START-UP PROCEDURE .....	8
FINAL SYSTEM CHECKS .....	8
<b>COMPONENTS</b> .....	<b>8</b>
CONTACTOR .....	8
CRANKCASE HEATER .....	9
CONDENSER MOTOR .....	9
COMPRESSOR .....	9
CONTACTOR RELAY .....	9
DEFROST CONTROL .....	9
OUTDOOR THERMOSTAT .....	9
REVERSING VALVE COIL .....	9
INDOOR BLOWER MOTOR .....	9
BLOWER INTERLOCK RELAY .....	9
<b>HEAT PUMP OPERATION</b> .....	<b>9</b>
COOLING CYCLE .....	9
HEATING CYCLE .....	9
DEFROST CONTROL .....	10
SUGGESTED FIELD TESTING/TROUBLE SHOOTING .....	10
AIRFLOW MEASUREMENT AND ADJUSTMENT .....	10
SPEED TAP ADJUSTMENTS	
FOR INDOOR BLOWER MOTOR .....	12

REFRIGERANT CHARGE CHECKS .....	12
<b>ELECTRICAL ADJUSTMENTS</b> .....	<b>12</b>
<b>MAINTENANCE</b> .....	<b>13</b>
SERVICE .....	13
INADEQUATE AIR VOLUME THROUGH INDOOR COIL .....	13
OUTSIDE AIR INTO RETURN DUCT .....	13
UNDERCHARGE .....	13
POOR "TERMINATING" SENSOR CONTACT .....	13
MALFUNCTIONING REVERSING VALVE -	
THIS MAY BE DUE TO: .....	13
<b>TROUBLESHOOTING CHART</b> .....	<b>14</b>
<b>APPENDIX</b> .....	<b>15</b>
<b>UNIT DIMENSIONS</b> .....	<b>15</b>
<b>MINIMUM CLEARANCES</b> .....	<b>16</b>
<b>RECOMMENDED FILTER SIZES</b> .....	<b>16</b>

 **WARNING**

INSTALLATION AND REPAIR OF THIS UNIT SHOULD BE PERFORMED ONLY BY INDIVIDUALS MEETING (AT A MINIMUM) THE REQUIREMENTS OF AN "ENTRY LEVEL TECHNICIAN" AS SPECIFIED BY THE AIR-CONDITIONING, HEATING, AND REFRIGERATION INSTITUTE (AHRI). ATTEMPTING TO INSTALL OR REPAIR THIS UNIT WITHOUT SUCH BACKGROUND MAY RESULT IN PRODUCT DAMAGE, PERSONAL INJURY OR DEATH.



### To THE INSTALLER

Carefully read all instructions for the installation prior to installing unit. Make sure each step or procedure is understood and any special considerations are taken into account before starting installation. Assemble all tools, hardware and supplies needed to complete the installation. Some items may need to be purchased locally. After deciding where to install unit, closely look the location over - both the inside and outside of home. Note any potential obstacles or problems that might be encountered as noted in this manual. Choose a more suitable location if necessary.

**IMPORTANT NOTE:** If a crankcase heater is used, the unit should be energized 24 hours prior to compressor start up to ensure crankcase heater has sufficiently warmed the compressor. Compressor damage may occur if this step is not followed.

### IMPORTANT NOTE TO THE OWNER REGARDING PRODUCT WARRANTY

Your warranty certificate is supplied as a separate document with the unit installed by your contractor. Read the limited warranty certificate carefully to determine what is and is not covered and keep the warranty certificate in a safe place. If you are unable to locate the warranty certificate please contact your installing contractor or contact customer service (877-254-4729) to obtain a copy.

**IMPORTANT:** To receive the 10-year Parts Limited Warranty, online registration must be completed within 60 days of installation. Online registration is not required in California or Quebec.

To register your Goodman brand unit, go to [www.goodmanmfg.com](http://www.goodmanmfg.com). Click on the word "Warranty" located on the left side of the home page. Next, click on the word

"Product Registration" located on the left side of the Warranty page and complete the forms in the manner indicated on the Product Registration page.

Product limited warranty certificates for models currently in production can be viewed at [www.goodmanmfg.com](http://www.goodmanmfg.com). If your model is not currently in production or does not appear on the website, please contact your installing contractor or contact customer service (877-254-4729) to obtain a copy of your warranty certificate.

Each product overview page contains a Product Warranty link; by clicking on it you will be able to view the limited warranty coverage for that specific product. To view warranty registration information, click on the Product Warranty text on the left navigation panel on the home page of each website. The Online Product Registration pages are located in this same section.

*Before using this manual, check the serial plate for proper model identification.*

*The installation and servicing of this equipment must be performed by qualified, experienced technicians only.*

## SHIPPING INSPECTION

Upon receiving the unit, inspect it for damage from shipment. Claims for damage, either shipping or concealed, should be filed immediately with the shipping company. Check the unit model number, specifications, electrical characteristics and accessories to determine if they are correct. In the event an incorrect unit is shipped, it must be returned to the supplier and must NOT be installed. The manufacturer assumes no responsibility for installation of incorrectly shipped units.

## REPLACEMENT PARTS

### ORDERING PARTS

When reporting shortages or damages, or ordering repair parts, give the complete unit model and serial numbers as stamped on the unit's nameplate.



Replacement parts for this appliance are available through your contractor or local distributor. For the location of your nearest distributor, consult the white business pages, the yellow page section of the local telephone book or contact:

CONSUMER AFFAIRS  
GOODMAN MANUFACTURING COMPANY, L.P.  
7401 SECURITY WAY  
HOUSTON, TEXAS 77040  
877-254-4729

## SAFETY INSTRUCTIONS

The following symbols and labels are used throughout this manual to indicate immediate or potential safety hazards. It is the owner's and installer's responsibility to read and comply with all safety information and instructions accompanying these symbols. Failure to heed safety information increases the risk of personal injury, property damage, and/or product damage.

 <b>WARNING</b>
<b>DO NOT CONNECT TO OR USE ANY DEVICE THAT IS NOT DESIGN-CERTIFIED BY GOODMAN FOR USE WITH THIS UNIT. SERIOUS PROPERTY DAMAGE, PERSONAL INJURY, REDUCED UNIT PERFORMANCE AND/OR HAZARDOUS CONDITIONS MAY RESULT FROM THE USE OF SUCH NON-APPROVED DEVICES.</b>

 <b>WARNING</b>
<b>HIGH VOLTAGE!</b> DISCONNECT ALL POWER BEFORE SERVICING OR INSTALLING THIS UNIT. MULTIPLE POWER SOURCES MAY BE PRESENT. FAILURE TO DO SO MAY CAUSE PROPERTY DAMAGE, PERSONAL INJURY OR DEATH.

 <b>WARNING</b>
<b>CONNECTING UNIT DUCT WORK TO UNAUTHORIZED HEAT PRODUCING DEVICES SUCH AS A FIREPLACE INSERT, STOVE, ETC. MAY RESULT IN PROPERTY DAMAGE, FIRE, CARBON MONOXIDE POISONING, EXPLOSION, PERSONAL INJURY OR DEATH.</b>

 <b>WARNING</b>
<b>THIS PRODUCT CONTAINS OR PRODUCES A CHEMICAL OR CHEMICALS WHICH MAY CAUSE SERIOUS ILLNESS OR DEATH AND WHICH ARE KNOWN TO THE STATE OF CALIFORNIA TO CAUSE CANCER, BIRTH DEFECTS OR OTHER REPRODUCTIVE HARM.</b>

 <b>WARNING</b>
<b>TO AVOID PROPERTY DAMAGE, PERSONAL INJURY OR DEATH, DO NOT USE THIS UNIT IF ANY PART HAS BEEN UNDER WATER. IMMEDIATELY CALL A QUALIFIED SERVICE TECHNICIAN TO INSPECT THE FURNACE AND TO REPLACE ANY PART OF THE CONTROL SYSTEM AND ANY GAS CONTROL HAVING BEEN UNDER WATER.</b>

 <b>WARNING</b>
<b>THIS UNIT MUST NOT BE USED AS A "CONSTRUCTION HEATER" DURING THE FINISHING PHASES OF CONSTRUCTION ON A NEW STRUCTURE. THIS TYPE OF USE MAY RESULT IN PREMATURE FAILURE OF THE UNIT DUE TO EXTREMELY LOW RETURN AIR TEMPERATURES AND EXPOSURE TO CORROSIVE OR VERY DIRTY ATMOSPHERES.</b>

 <b>WARNING</b>
<b>TO PREVENT THE RISK OF PROPERTY DAMAGE, PERSONAL INJURY, OR DEATH, DO NOT STORE COMBUSTIBLE MATERIALS OR USE GASOLINE OR OTHER FLAMMABLE LIQUIDS OR VAPORS IN THE VICINITY OF THIS APPLIANCE.</b>

## CODES AND REGULATIONS

The GPC/GPH M-series air conditioners and heat pumps are designed for OUTDOOR USE ONLY. GPH M-Series is available in cooling capacities of 2, 2-1/2, 3, 3-1/2, 4 and 5 nominal tons of cooling. GPC M-Series is available in cooling capacities of 3, 4 and 5 nominal tons of cooling. Optional field installed heat kits are available in 5,8,10,15 and 20 kW. 3 phase heat kits are available only in 15 and 20 kW. The units can be easily installed in manufactured or modular homes with existing high-static duct work. The units can also be easily converted to accommodate a plenum for normal or low-static applications. The GPC/GPH M-series are self contained packaged units so the only connections needed for installation are the supply and return ducts, the line and low voltage wiring and drain connection. The units are ETL listed and AHRI certified.

The information on the rating plate is in compliance with the FTC & DOE rating for single phase units. The three phase units in this series are not covered under the DOE certified program. The efficiency ratings of these units are a product of thermal efficiency determined under continuous operating conditions independent of any installed system.

## EPA REGULATIONS

**IMPORTANT: THE UNITED STATES ENVIRONMENTAL PROTECTION AGENCY (EPA) HAS ISSUED VARIOUS REGULATIONS REGARDING THE INTRODUCTION AND DISPOSAL OF REFRIGERANTS IN THIS UNIT. FAILURE TO FOLLOW THESE REGULATIONS MAY HARM THE ENVIRONMENT AND CAN LEAD TO THE IMPOSITION OF SUBSTANTIAL FINES. BECAUSE REGULATIONS MAY VARY DUE TO PASSAGE OF NEW LAWS, WE SUGGEST A CERTIFIED TECHNICIAN PERFORM ANY WORK DONE ON THIS UNIT. SHOULD YOU HAVE ANY QUESTIONS PLEASE CONTACT THE LOCAL OFFICE OF THE EPA.**

## NATIONAL CODES

This product is designed and manufactured to permit installation in accordance with National Codes. It is the installer's responsibility to install the product in accordance with National Codes and/or prevailing local codes and regulations.

## MAJOR COMPONENTS

The unit includes a hermetically sealed refrigerating system (consisting of a compressor, condenser coil, evaporator coil with flowrator), an indoor blower, a condenser fan and all necessary internal electrical wiring. The heat pump also includes a reversing valve, solenoid, defrost thermostat and control and loss of charge protection. The system is factory-evacuated, charged and performance tested. Refrigerant amount and type are indicated on rating plate.

## PRE-INSTALLATION CHECKS

Before attempting any installation, the following points should be considered:

- Structural strength of supporting members
- Clearances and provision for servicing
- Power supply and wiring
- Air duct connections
- Drain facilities and connections
- Location may be on any four sides of a home, manufactured or modular, to minimize noise

## CLEARANCES AND ACCESSIBILITY

The unit is designed to be located outside the building with unobstructed condenser air inlet and discharge. Additionally, the unit must be situated to permit access for service and installation. Condenser air enters from three sides. Air discharges upward from the top of the unit. Refrigerant gauge connections are made on the right side of the unit as you face the compressor compartment. Electrical connections can be made either on the right, bottom or duct panel side of the unit. The best and most common application is for the unit to be located 10" from wall (4" minimum) with the connection side facing the wall. This "close to the wall" application minimizes exposed wiring.

Close to the wall application assures free, unobstructed air to the other two sides. In more confined application spaces, such as corners provide a minimum 10" clearance on all air inlet sides.

Allow 18" minimum for service access to the compressor compartment and controls. The top of the unit should be completely unobstructed. If units are to be located under an overhang, there should be a minimum of 36" clearance and provisions made to deflect the warm discharge air out from the overhang.

## UNIT LOCATION

Consider the affect of outdoor fan noise on conditioned space and any adjacent occupied space. It is recommended that the unit be placed so that condenser air discharge does not blow toward windows less than 25 feet away. Consideration should also be given to shade and unit appearance.

Heat pumps require special location consideration in areas of heavy snow accumulation and/or areas with prolonged continuous sub-freezing temperatures. Heat pump unit bases have holes under the outdoor coil to permit drainage of defrost water accumulation. The unit must be situated to permit free unobstructed drainage of the defrost water and ice. A minimum 2" clearance under the outdoor coil is required in the milder climates.

## GROUND LEVEL PRE-INSTALLATION DETAILS

The unit should be set on a solid, level foundation - preferably a concrete slab at least 4 inches thick. The slab should be above ground level and surrounded by a graveled area for good drainage. Any slab used as a unit's foundation should not adjoin the building as it is possible that sound and vibration may be transmitted to the structure.

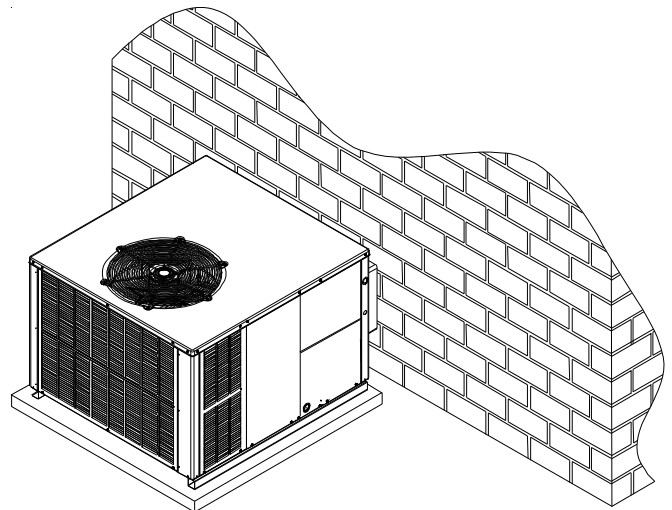

**Ground Level Installation**

## ROOF TOP PRE-INSTALLATION DETAILS

Ensure that the roof is weather tight and allows proper drainage of condensation. Use steel or treated wood beams as unit support for load distribution.

**NOTE:** To ensure proper condensate drainage, unit must be installed in a level position.

- To avoid possible property damage or personal injury, the roof must have sufficient structural strength to carry the weight of the unit(s) and snow or water loads as required by local codes. Consult a structural engineer to determine the weight capabilities of the roof.
- The unit may be installed directly on wood floors or on Class A, Class B, or Class C roof covering material.
- To avoid possible personal injury, a safe, flat surface for service personnel should be provided.

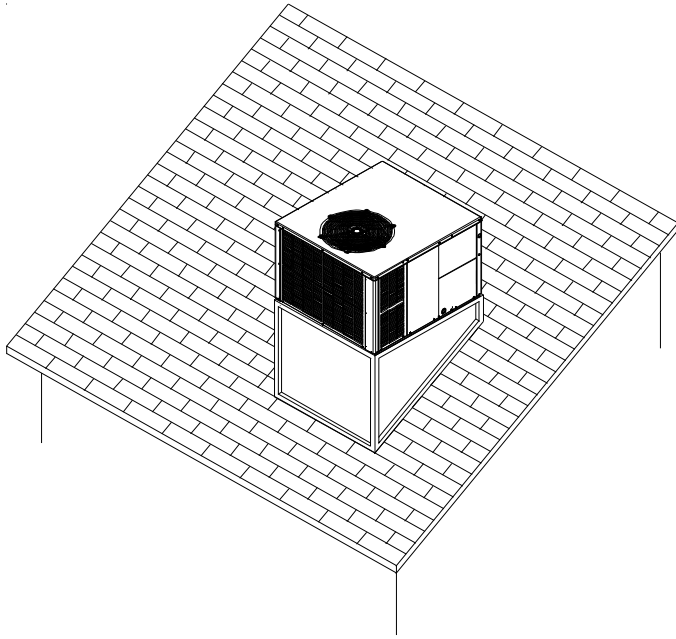

**Rooftop Installation**

**ROOF CURB INSTALLATIONS ONLY**

**NOTE:** Sufficient structural support must be determined prior to locating and mounting the curb and package unit.

Curb insulation, cant strips, flashing and general roofing material are furnished by the contractor.

Curbing must be installed in compliance with the National Roofing Contractors Association Manual. Construct duct work using current industry guidelines. The duct work must be placed into the roof curb **before** mounting the package unit.

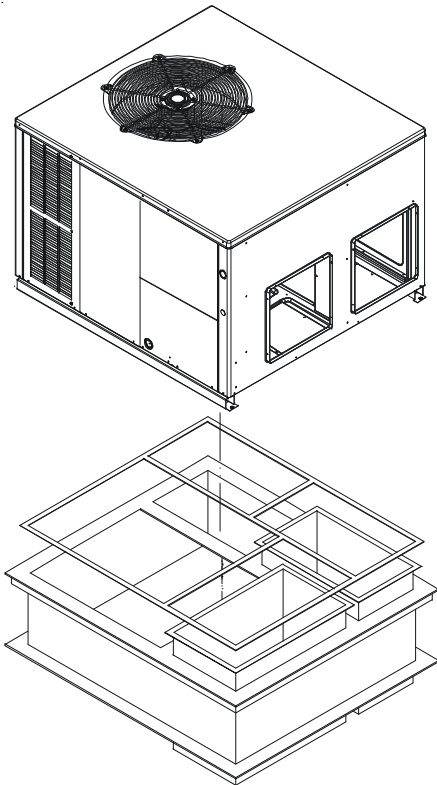

**Roof Curb Installation**

**RIGGING DETAILS**

**WARNING**

**TO PREVENT PROPERTY DAMAGE, THE UNIT SHOULD REMAIN IN AN UPRIGHT POSITION DURING ALL RIGGING AND MOVING OPERATIONS. TO FACILITATE LIFTING AND MOVING WHEN A CRANE IS USED, PLACE THE UNIT IN AN ADEQUATE CABLE SLING.**

**WARNING**

**TO AVOID POSSIBLE PROPERTY DAMAGE, PERSONAL INJURY OR DEATH, ENSURE THE ROOF HAS SUFFICIENT STRUCTURAL STRENGTH TO CARRY THE WEIGHT OF THE UNIT(S), ROOF CURB, SNOW LOADS, AND WATER LOADS AS REQUIRED BY LOCAL CODES. CONSULT A STRUCTURAL ENGINEER TO DETERMINE THE WEIGHT CAPABILITIES OF THE ROOF.**

**CAUTION**

**TO AVOID POSSIBLE PERSONAL INJURY, A SAFE, FLAT SURFACE FOR SERVICE PERSONNEL SHOULD BE PROVIDED.**

**IMPORTANT:** If using bottom discharge with roof curb, duct work should be attached to the curb prior to installing the unit. Lower unit carefully onto roof mounting curb. While rigging unit, center of gravity will cause condenser end to be lower than supply air end.

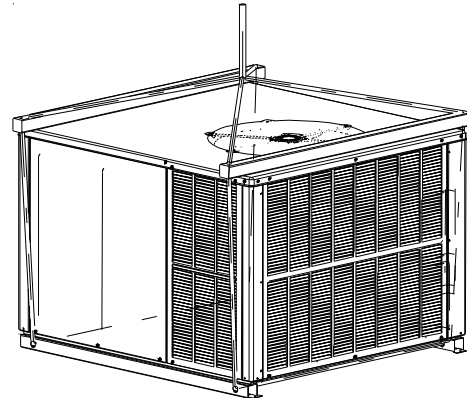

**Rigging**

**CIRCULATING AIR AND FILTERS**

**AIRFLOW CONVERSION**

Units can easily be converted from horizontal to down-discharge airflow delivery. In down-discharge or high static installations, the installer should measure the total external static and review the blower performance charts before performing the installation. In some installations it will be necessary to change the blower speed to provide proper air flow.

**Horizontal Air Flow (Applies to 3 phase models)**

*Single phase models are shipped without horizontal duct covers. If needed, these kits may be ordered through Goodman's Service Parts department.*

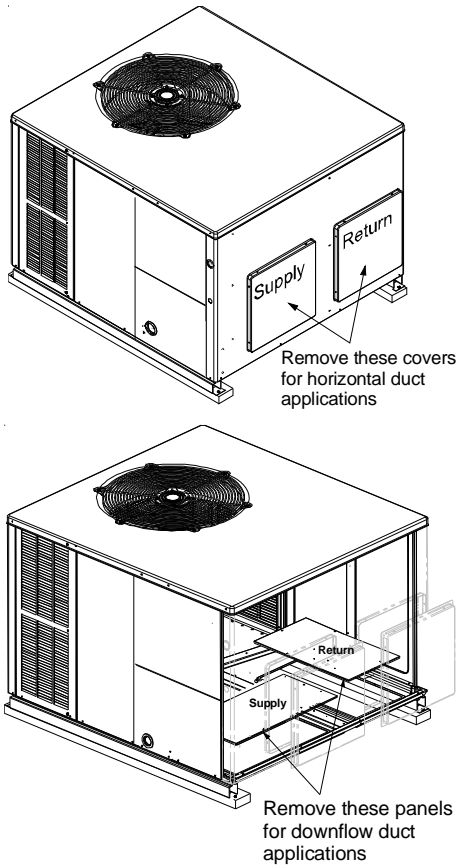

### Duct Cover Installation

#### Down Discharge Applications

Cut insulation around bottom openings and remove panels from the bottom of the unit, saving the screws holding the panels in place.

**NOTE:** Single phase models require installation of horizontal duct kit #20464501PDGK (medium chassis) and #20464502PDGK (large chassis).

#### DUCT WORK

Duct systems and register sizes must be properly designed for the C.F.M. and external static pressure rating of the unit. Duct work should be designed in accordance with the recommended methods of Air Conditioning Contractors of America Manual D (Residential) or Manual Q (Commercial). All ductwork exposed to the outdoors must include a weatherproof barrier and adequate insulation.

A duct system should be installed in accordance with Standards of the National Board of Fire Underwriters for the Installation of Air Conditioning, Warm Air Heating and Ventilating Systems. Pamphlets No. 90A and 90B.

The supply duct from the unit through a wall may be installed without clearance. However, minimum unit clearances as shown in the appendix must be maintained. The supply duct should be provided with an access panel large enough to inspect the air chamber downstream of the heat exchanger. A cover should be tightly attached to prevent air leaks.

For duct flange dimensions on the unit refer to the Unit Dimension illustration in the appendix.

For down-discharge applications, the ductwork should be attached to the roof curb prior to installing the unit. Duct work dimensions are shown in the roof curb installation manual.

If desired, supply and return duct connections to the unit may be made with flexible connections to reduce possible unit operating sound transmission.

## FILTERS



TO PREVENT PROPERTY DAMAGE DUE TO FIRE AND LOSS OF EQUIPMENT EFFICIENCY OR EQUIPMENT DAMAGE DUE TO DUST AND LINT BUILD UP ON INTERNAL PARTS, NEVER OPERATE UNIT WITHOUT AN AIR FILTER INSTALLED IN THE RETURN AIR SYSTEM.

Filters are not provided with unit and must be supplied and externally installed in the return duct system by the installer. An optional factory approved internal filter rack may also be used. A field-installed filter grille is recommended for easy and convenient access to the filters for periodic inspection and cleaning. When installing filters, ensure the air flow arrows on the filter are pointing toward the circulator blower.

Refer to the unit filter size chart below for filter size information.

MINIMUM FILTER SIZE	
NOMINAL SIZE (INCHES)	NOMINAL AREA (SQ. FT.)
10x20	1.4
14x20	1.9
14x25	2.4
15x20	2.1
16x20	2.2
16x25	2.8
20x20	2.8
20x25	3.5
25x25	4.3

**NOTE:** Filters must have adequate face area for the rated quantity of the unit. See the air delivery table below for recommended filter size. Size the filters in accordance with their manufacturer recommendations. Throwaway filters must be sized for a maximum face velocity of 300 feet per minute.

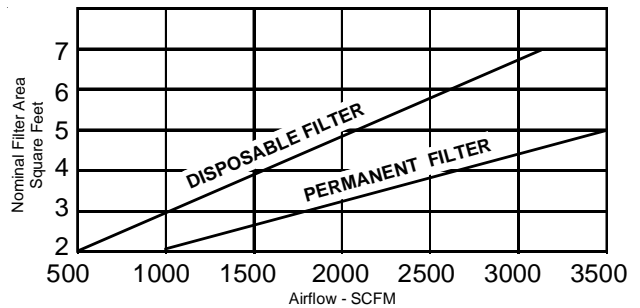

## PIPING

### CONDENSATE DRAIN

The condensate drain connection of the evaporator is a half coupling of 3/4" N.P.T. A trap must be provided to have Proper condensate drainage.

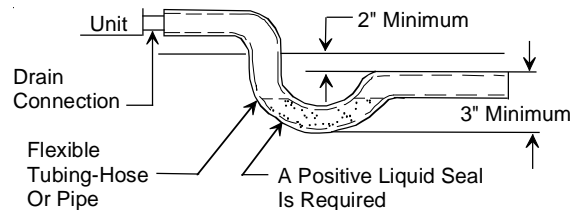

Install condensate drain trap as shown. Use 3/4" drain connection size or larger. Do not operate without trap. Unit must be level or slightly inclined toward drain.



## WIRING

**NOTE:** All wiring should be made in accordance with the National Electrical Code.

Consult your local Power Company to determine the availability of sufficient power to operate the unit. Check the voltage, frequency, and phase at the power supply to ensure it corresponds to the unit's RATED VOLTAGE REQUIREMENT.

In accordance with the N.E.C. or local codes, install a branch circuit fused disconnect near the unit. Determine wire sizes and overcurrent protection from the unit nameplate ampacity and in accordance with the Minimum Filter Size or the N.E.C. The wiring should **never** be sized smaller than is recommended by either of these two sources.

Fuses smaller than that recommended on the rating plate could result in unnecessary fuse failure or service calls. The use of protective devices of larger size than indicated could result in extensive damage to the equipment. The manufacturer bears no responsibility for damage caused to equipment as result of the use of larger than is recommended size protective devices.

All units have undergone a run test prior to packaging for shipment. This equipment has been started at minimum rated voltage and checked for satisfactory operation. Do not attempt to operate this unit if the voltage is not within the minimum and maximum voltages shown on nameplate.

All exterior wiring must be within approved weatherproof conduit. The unit must be **permanently grounded** in accordance with local codes, or in absence of local codes, with N.E.C ANSI/ NFPA NO. 70-1984 or latest edition by using ground lug in the control box.

Fuses or HACR type circuit breakers may be used where codes permit.

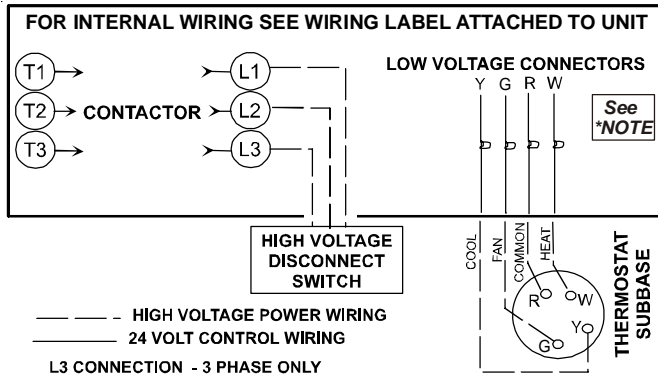

**\*NOTE:** LOW VOLTAGE CONNECTORS do not apply to heat pumps with electric heat. LOW VOLTAGE CONNECTORS apply ONLY to GPC units with electric heat.

**IMPORTANT NOTE:** Some single phase units are equipped with a single-pole contactor. Exercise caution when servicing as only one leg of the power supply is broken with the contractor.

To wire the unit, make the following high and low voltage connections.

WARNING

**HIGH VOLTAGE!**  
 DISCONNECT ALL POWER BEFORE SERVICING OR INSTALLING THIS UNIT. MULTIPLE POWER SOURCES MAY BE PRESENT. FAILURE TO DO SO MAY CAUSE PROPERTY DAMAGE, PERSONAL INJURY OR DEATH.

CAUTION

TO AVOID PROPERTY DAMAGE OR PERSONAL INJURY DUE TO FIRE, USE ONLY COPPER CONDUCTORS.

CAUTION

TO AVOID THE RISK OF ELECTRICAL SHOCK, WIRING TO THE UNIT MUST BE POLARIZED AND GROUNDED.

### HIGH VOLTAGE WIRING

- Single Phase- Two leads should be connected to terminals L1 & L2 in the electrical control section, using wire sizes specified in wiring table.
- Three Phase- Three leads should be connected to terminals L1, L2 and L3 in the electrical section, using wire sizes specified in wiring table.

### LOW VOLTAGE WIRING

- Air Conditioners- Connect 24V wires from the thermostat to the corresponding wires in the control box using No. 18 AWG as follows:

LEAD	THERMOSTAT
Red	R (24V)
Green	G (Fan)
Yellow	Y (Cool)
White	W1 (Heat)*
Brown	W2 (Heat)*

- Heat Pumps- Connect 24V wires from the thermostat to the corresponding wires in the control box using No. 18 AWG as follows:

TERMINAL	THERMOSTAT
Red	R (24V)
Green	G (Fan)
Orange	O (Rev. Valve)
White	W1 (Heat, 2nd)*
Brown	W2 (Heat 3rd)*
Yellow	Y (Cool)
C (Blue)	C (Common)

\*Optional field installed heat connections

### INTERNAL WIRING

A diagram detailing the internal wiring of this unit is located on the electrical box cover. If any of the original wire supplied with the appliance must be replaced, the wire gauge and insulation must be the same as the original wiring.

Transformer is wired for 230 volts on the 208/230 models. See wiring diagram for 208 volt wiring.

1. For branch circuit wiring (main power supply to unit disconnect), the minimum wire size for the length of run can be determined using the circuit ampacity found on the unit rating plate and the table below. From the unit disconnect to unit, the smallest wire size allowable may be used for the ampacity, **as the Disconnect must be in sight of the unit.**

BRANCH CIRCUIT AMPACITY	15	20	25	30	35	40	45	50
SUPPLY WIRE LENGTH - FEET								
200	6	4	4	4	3	3	2	2
150	8	6	6	4	4	4	3	3
100	10	8	8	6	6	6	4	4
50	14	12	10	10	8	8	6	6

- Wire size based on 60° C rated wire insulation and 30° C Ambient Temperature (86° F).
- For more than 3 conductors in a raceway or cable, see the N.E.C. for derating the ampacity of each conductor.

## STARTUP, ADJUSTMENTS, AND CHECKS

**WARNING**

**HIGH VOLTAGE!**  
DISCONNECT ALL POWER BEFORE SERVICING OR INSTALLING THIS UNIT. MULTIPLE POWER SOURCES MAY BE PRESENT. FAILURE TO DO SO MAY CAUSE PROPERTY DAMAGE, PERSONAL INJURY OR DEATH.



### START-UP PROCEDURE AND CHECKLIST

With power turned off at all disconnects:

- Turn thermostat system switch to “COOL” and fan switch to “AUTO”. Next, turn the temperature setting as high as it will go.
- Inspect all registers and set them to the normal open position.
- Turn on the electrical supply at the disconnect.
- Turn the fan switch to the “ON” position. The blower should operate after a 7-second delay.
- Turn the fan switch to “AUTO” position. The blower should stop after a 65-second delay.
- Slowly lower the cooling temperature until the unit starts. The compressor, blower and fan should now be operating. Allow the unit to run 10 minutes, make sure cool air is being supplied by the unit.
- Turn the temperature setting to the highest position, stopping the unit. The indoor blower will continue to run for 65-seconds.
- Turn the thermostat system switch to “OFF” and disconnect all power when servicing the unit.

### HEAT PUMP START-UP PROCEDURE

- Check the cooling mode for the heat pump in the same manner as above. The reversing valve is energized when the thermostat is placed in the cooling position. A clicking sound should be noticeable from the reversing valve. By lowering the temperature setting to call for cooling, the contractor is energized. The compressor, blower and fan should then be running. After the cooling mode is checked out, turn the thermostat system switch to “OFF”.
- Turn the thermostat system switch to “HEAT” and fan switch to “AUTO”.

- Slowly raise the heating temperature setting. When the heating first stage makes contact, stop raising the temperature setting.. The compressor, blower and fan should now be running with the reversing valve in the de-energized (heating) position. After giving the unit time to settle out, make sure the unit is supplying heated air.
  - If the outdoor ambient is above 80°F, the unit may trip on its high pressure cut out when on heating. The compressor should stop. The heating cycle must be thoroughly checked, so postpone the test to another day when conditions are more suitable. DO NOT FAIL TO TEST.
  - If the outdoor ambient is low and the unit operates properly on the heating cycle, you may check the pressure cutout operation by blocking off the indoor return air until the unit trips.
  - If unit operates properly in the heating cycle, raise the temperature setting until the heating second stage makes contact. Supplemental resistance heat, if installed should now come on. Make sure it operates properly.
- NOTE:** If outdoor thermostats are installed, the outdoor ambient must be below the set point of these thermostats for the heaters to operate. It may be necessary to jumper these thermostats to check heater operation if outdoor ambient is mild.
- For thermostats with emergency heat switch, return to step 6. The emergency heat switch is located at the bottom of the thermostat. Move the switch to emergency heat. The heat pump will stop, the blower will continue to run, all heaters will come on and the thermostat emergency heat light will come on. 3-phase models are single stage heat only.
  - If checking the unit in the wintertime, when the outdoor coil is cold enough to actuate the defrost control, observe at least one defrost cycle to make sure the unit defrosts completely.

### FINAL SYSTEM CHECKS

- Check to see if all supply and return air grilles are adjusted and the air distribution system is balanced for the best compromise between heating and cooling.
- Check for air leaks in the ductwork.
- See Sections on **Air Flow Measurement and Adjustment and Checking Charge**.
- Make sure the unit is free of “rattles”, and the tubing in the unit is free from excessive vibration. Also make sure tubes or lines are not rubbing against each other or sheet metal surfaces or edges. If so, correct the trouble.
- Set the thermostat at the appropriate setting for cooling and heating or automatic changeover for normal use.
- Be sure the Owner is instructed on the unit operation, filter, servicing, correct thermostat operation, etc.

The foregoing “Start-up Procedure and Check List” is recommended to serve as an indication that the unit will operate normally.

## COMPONENTS

### Contactors

This control is activated (closed) by the room thermostat for both heating and cooling. The contactor has a 24V coil and supplies power to the compressor and outdoor fan motor.



## Crankcase Heater

This item is "ON" whenever power is supplied to the unit and the crankcase heater thermostat is closed. Crankcase heater thermostat closes at 67° and opens at 85°. It warms the compressor crankcase thereby preventing liquid migration and subsequent compressor damage. The insert type heater is self regulating. It is connected electrically to the contactor L1 and L2 terminals.

## Condenser Motor

This item is activated by the contactor during heating and cooling, except during defrost and emergency heat operation.

## Compressor

This item is activated by the contactor for heating and cooling, except during emergency heat. It is protected by an internal overload.

## Contactor Relay

This control is activated by the thermostat (24V coil) and supplies power to the contactor.

## Defrost Control

The Defrost control provides time/temperature initiation and termination of the defrost cycle. When a Defrost cycle is initiated, the defrost control shifts the reversing valve to "COOLING" mode, stops the outdoor fan and brings on supplemental heat. Normally, a Defrost cycle will take only 2-3 minutes unless system is low on charge or outdoor conditions are severe. (windy and cold). The defrost control also provides for a 3 minute off cycle compressor delay.

## Outdoor Thermostat

These optional controls are used to prevent full electric heater operation at varying outdoor ambient (0° F-to 45° F). They are normally open above their set points and closed below to permit staging of indoor supplement heater operation. If the outdoor ambient temperature is below 0° F (-18° C) with 50% or higher RH, an outdoor thermostat (OT) must be installed and set at (0°) on the dial. Failure to comply with this requirement may result in damage to the product which may not be covered by the manufacturer's warranty.

## Reversing Valve Coil

This coil is activated by the thermostat, in the cooling mode and during defrost. It positions the reversing valve pilot valve for cooling operation.

## Indoor Blower Motor

This is activated by the room thermostat by COOLING or FAN ON position. The motor is energized through the EBTDR for PSC motors and directly by the room thermostat for X-13 motors (4 or 5 Ton units). X-13 motors are constant torque motors with very low power consumption. This motor is energized by a 24V signal from the thermostat. (See *Air Flow Measurement and Adjustment* for speed adjustment instructions).

## Blower Interlock Relay (Single Phase PSC Models Only)

This relay is used to energize the blower during the electric heat operation. Some room thermostats do not energize the motor during electric heat. This relay insures blower operation when the room thermostat energizes heat. This relay has a 240 volt coil and an 8 amp contact relay. This relay is energized by the electric heat kit sequencer.

# HEAT PUMP OPERATION

## COOLING CYCLE

When the heat pump is in the cooling cycle, it operates exactly as a Summer Air Conditioner unit. In this mode, all the charts and data for service that apply to summer air conditioning apply to the heat pump. Most apply on the heating cycle except that "condenser" becomes "evaporator", "evaporator" becomes "condenser", "cooling" becomes "heating".

## HEATING CYCLE

The heat pump operates in the heating cycle by redirecting refrigerant flow through the refrigerant circuit external to the compressor. This is accomplished with through the reversing valve. Hot discharge vapor from the compressor is directed to the indoor coil (evaporator on the cooling cycle) where the heat is removed, and the vapor condenses to liquid. It then goes through the expansion device to the outdoor coil (condenser on the cooling cycle) where the liquid is evaporated, and the vapor goes to the compressor.

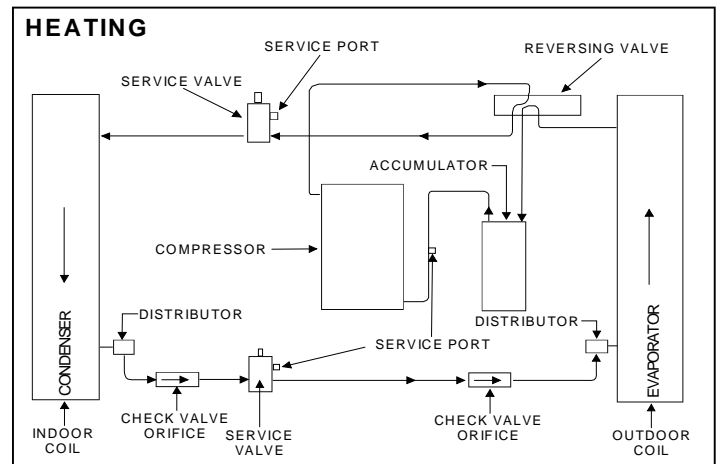
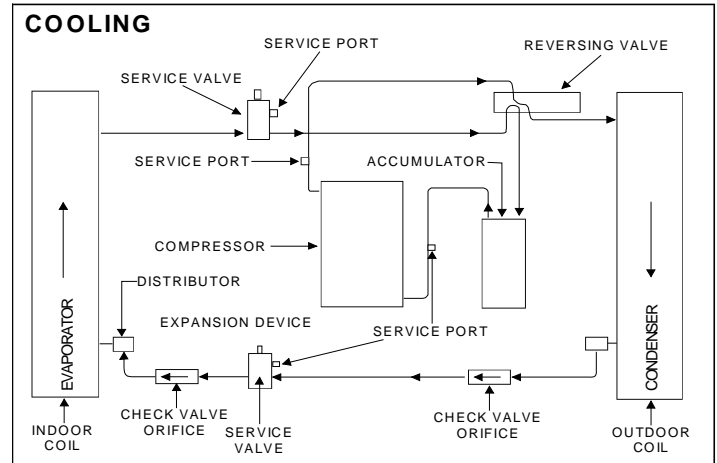

When the solenoid valve coil is operated either from heating to cooling or vice versa, the piston in the reversing valve to the low pressure (high pressure) reverse positions in the reversing valve. The following figures show a schematic of a heat pump on the cooling cycle and the heating cycle. In addition to a reversing valve, a heat pump is equipped with an expansion device and check valve for the indoor coil, and similar equipment for the outdoor coil. It is also provided with a defrost control system.

The expansion devices are flowrator distributors and perform the same function on the heating cycle as on the cooling cycle. The flowrator distributors also act as check valves to allow for the reverse of refrigerant flow.

When the heat pump is on the heating cycle, the outdoor coil is functioning as an evaporator. The temperature of the refrigerant in the outdoor coil must be below the temperature of the outdoor air in order to extract heat from the air. Thus, the greater the difference in the outdoor temperature and the outdoor coil temperature, the greater the heating capacity of the heat pump. This phenomenon is a characteristic of a heat pump. It is a good practice to provide

supplementary heat for all heat pump installations in areas where the temperature drops below 45° F. It is also a good practice to provide sufficient supplementary heat to handle the entire heating requirement should there be a component failure of the heat pump, such as a compressor, or refrigerant leak, etc.

Since the temperature of the refrigerant in the outdoor coil on the heating cycle is generally below freezing point, frost forms on the surfaces of the outdoor coil under certain weather conditions of temperature and relative humidity. Therefore, it is necessary to reverse the flow of the refrigerant to provide hot gas in the outdoor coil to melt the frost accumulation. This is accomplished by reversing the heat pump to the cooling cycle. At the same time, the outdoor fan stops to hasten the temperature rise of the outdoor coil and lessen the time required for defrosting. The indoor blower continues to run and the supplementary heaters are energized.

## DEFROST CONTROL

During operation the power to the circuit board is controlled by a temperature sensor, which is clamped to a feeder tube entering the outdoor coil. Defrost timing periods of 30, 60 and 90 minutes may be selected by setting the circuit board jumper to 30, 60 and 90 respectively. Accumulation of time for the timing period selected starts when the sensor closes (approximately 31° F), and when the wall thermostat calls for heat. At the end of the timing period, the unit's defrost cycle will be initiated provided the sensor remains closed. When the sensor opens (approximately 75° F), the defrost cycle is terminated and the timing period is reset. If the defrost cycle is not terminated due to the sensor temperature, a twelve minute override interrupts the unit's defrost period.

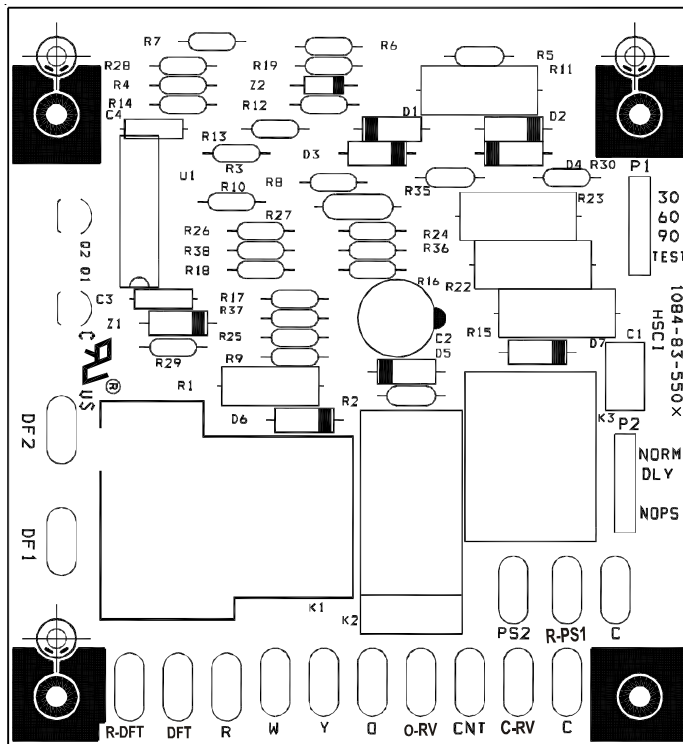

## SUGGESTED FIELD TESTING/TROUBLE SHOOTING

1. Run unit in the heating mode (room thermostat calling for heat).
2. Check unit for proper charge. **Note: Bands of frost on the condenser coil indicate low refrigerant charge.**
3. Shut off power to unit.

4. Disconnect outdoor fan by removing the outdoor fan motor wire from "DF2" on defrost control.
5. Restart unit and allow frost to accumulate.
6. After a few minutes of operation, the unit's defrost thermostat should close. To verify this, check for 24 volts between "DFT" and "C" on board. If the temperature at the thermostat is less than 28° F and the thermostat is open, replace the unit's defrost thermostat, as it is defective.
7. When the unit's defrost thermostat has closed, short the test pins on the defrost board until the reversing valve shifts, indicating defrost. This should take up to 21 seconds depending on what timing period the control is set on. After defrost initiation, the short must instantly be removed or the unit's defrost period will only last 2.3 seconds.
8. The control is shipped from the factory with the compressor delay option selected. This will de-energize the compressor contactor for 30 seconds on defrost initiation and defrost termination. If the jumper is set to Normal, the compressor will continue to run during defrost initiation and defrost termination. The control will also ignore the low pressure switch connected to R-PS1 and PS2 for 5 minutes upon defrost initiation and 5 minutes after defrost termination.
9. After the unit's defrost thermostat has terminated, check the defrost thermostat for 24 volts between "DFT" and "C". The reading should indicate 0 volts (open sensor).
10. Shut off power to unit.
11. Replace outdoor fan motor lead to terminal "DF2" on defrost board and turn on power.

## AIRFLOW MEASUREMENT AND ADJUSTMENT

After reviewing *Duct Work* section, proceed with airflow measurements and adjustments. The unit blower curves (see Specification Sheets) are based on external static pressure (ESP per in/wc). The duct openings on the unit are considered internal static pressure. As long as ESP is maintained, the unit will deliver the proper air up to the maximum static pressure listed for the CFM required by the application (i.e. home, building, etc.)

In general, 400 CFM per ton of cooling capacity is a rule of thumb. Some applications depending on the sensible and latent capacity requirements may need only 350 CFM or up to 425 CFM per ton. Check condition space load requirements (from load calculations) and equipment expanded ratings data to match CFM and capacity. After unit is set and duct work completed, verify the ESP with a 1-inch inclined manometer with pitot tubes or a Magnahelic gauge and confirm CFM to blower curves in the Specification Sheets. All units have three-speed blower motors. If low speed is not utilized, the speed tap can be changed to medium or high speed.

**NOTE:** Never run CFM below 350 CFM per ton, evaporator freezing or poor unit performance is possible.

Model	Speed	Volts	E.S.P (In. of H <sub>2</sub> O)								
			0.1	0.2	0.3	0.4	0.5	0.6	0.7	0.8	
GPC1336M41* GPC1336M43*	LOW	230	CFM	1122	1078	1032	972	915	804	687	558
			WATTS	338	330	321	310	300	283	264	250
	MED	230	CFM	1387	1331	1264	1209	1119	1041	935	748
			WATTS	456	440	428	412	399	382	363	330
	HIGH	230	CFM	1521	1454	1388	1311	1230	1144	1055	939
			WATTS	534	521	510	490	477	461	442	420
GPC1348M41* GPC1348M43*	T1 (G)	230	CFM	1,140	1,395	1,360	1,310	1,265	1,235	1,190	1,130
			WATTS	275	285	295	315	325	335	345	355
	T2 / T3	230	CFM	1,795	1,765	1,715	1,695	1,650	1,600	1,500	1,375
			WATTS	475	490	505	520	530	535	510	475
	T4 / T5	230	CFM	1,860	1,820	1,785	1,745	1,700	1,625	1,515	1,395
			WATTS	515	530	545	565	570	550	535	485
GPC1360M41* GPC1360M43*	T1 (G)	230	CFM	1,755	1,720	1,685	1,645	1,615	1,570	1,530	1,465
			WATTS	420	435	455	460	475	490	500	500
	T2 / T3	230	CFM	1,850	1,820	1,775	1,735	1,705	1,675	1,610	1,495
			WATTS	480	500	515	525	535	555	545	520
	T4 / T5	230	CFM	2,180	2,125	2,050	1,975	1,875	1,800	1,655	1,530
			WATTS	770	755	725	700	675	640	575	540

**NOTES:**

- Data shown is dry coil.  
Wet coil pressure drop is approximately:  
0.1" H<sub>2</sub>O, for two-row indoor coil;  
0.2" H<sub>2</sub>O, for three-row indoor coil;  
and 0.3" H<sub>2</sub>O, for four-row indoor coil.
- Data shown does not include filter pressure drop, approx. 0.08" H<sub>2</sub>O.
- ALL MODELS SHOULD RUN NO LESS THAN 350 CFM/TON.
- Reduce airflow by 2% for 208-volt operation.

Model	Speed	Volts	E.S.P (In. of H <sub>2</sub> O)								
			0.1	0.2	0.3	0.4	0.5	0.6	0.7	0.8	
GPH1324M41*	Low	230	CFM	667	596	-----	-----	-----	-----	-----	-----
			WATTS	153	150	-----	-----	-----	-----	-----	-----
	Med	230	CFM	897	841	784	713	610	-----	-----	-----
			WATTS	233	229	224	217	207	-----	-----	-----
	High	230	CFM	1242	1181	1122	1057	982	883	719	617
			WATTS	373	364	354	344	333	318	298	284
GPH1330M41*	Low	230	CFM	1097	1059	1016	959	901	818	648	562
			WATTS	337	330	324	315	305	290	271	257
	Med	230	CFM	1253	1204	1148	1097	1033	952	777	670
			WATTS	397	388	379	369	356	342	313	297
	High	230	CFM	1448	1380	1323	1258	1194	1106	1008	864
			WATTS	499	483	472	459	446	427	410	382
GPH1336M41*	Low	230	CFM	1122	1078	1032	972	915	804	687	558
			WATTS	338	330	321	310	300	283	264	250
	Med	230	CFM	1387	1331	1264	1209	1119	1041	935	748
			WATTS	456	440	428	412	399	382	363	330
	High	230	CFM	1521	1454	1388	1311	1230	1144	1055	939
			WATTS	534	521	510	490	477	461	442	420
HIGH	230	CFM	1,565	1,510	1,415	1,340	1,260	1,135	1,035	885	
		WATTS	495	480	460	445	425	405	385	355	
GPH1342M41*	Low	230	CFM	1122	1078	1032	972	915	804	687	558
			WATTS	338	330	321	310	300	283	264	250
	Med	230	CFM	1387	1331	1264	1209	1119	1041	935	748
			WATTS	456	440	428	412	399	382	363	330
	High	230	CFM	1521	1454	1388	1311	1230	1144	1055	939
			WATTS	534	521	510	490	477	461	442	420
GPH1348M41*	T1 (G)	230	CFM	1,140	1,395	1,360	1,310	1,265	1,235	1,190	1,130
			WATTS	275	285	295	315	325	335	345	355
	T2 / T3 (W2)	230	CFM	1,795	1,765	1,715	1,695	1,650	1,600	1,500	1,375
			WATTS	475	490	505	520	530	535	510	475
	T4 / T5 (Y)	230	CFM	1,860	1,820	1,785	1,745	1,700	1,625	1,515	1,395
			WATTS	515	530	545	565	570	550	535	485
GPH1360M41*	T1 (G)	230	CFM	1,755	1,720	1,685	1,645	1,615	1,570	1,530	1,465
			WATTS	420	435	455	460	475	490	500	500
	T2 / T3 W2	230	CFM	1,850	1,820	1,775	1,735	1,705	1,675	1,610	1,495
			WATTS	480	500	515	525	535	555	545	520
	T4 / T5 Y	230	CFM	2,180	2,125	2,050	1,975	1,875	1,800	1,655	1,530
			WATTS	770	755	725	700	675	640	575	540

## SPEED TAP ADJUSTMENTS FOR INDOOR BLOWER MOTOR

### PSC Motor

Adjust the CFM by changing the speed tap of the indoor blower motor at the EBTD "COM" connection with one of the speed taps on "M1" or "M2". (Black-High Speed, Blue-Medium Speed, Red-Low Speed.)

### X-13 Motor

Adjust the CFM by changing the 24V low voltage lead at the speed terminal block on the motor. (T1-Low Speed, T2 and T3-Medium Speed, T4 and T5-High Speed).

## REFRIGERANT CHARGE CHECKS

After completing airflow measurements and adjustments, the unit's refrigerant charge must be checked. The unit is factory charged based on 400 CFM per ton at minimum ESP per AHRI test conditions (generally between .15 - .25 ESP). When air quantity or ESP differs from this, charge must be readjusted to the proper amount. All package units are charged to the superheat method at the compressor suction line (these are fixed orifice devices).

For charging in the warmer months, 8 +/-3°F superheat at the compressor is required at conditions: 95°F outdoor ambient (dry bulb temperature), 80°F dry bulb / 67°F wet bulb indoor ambient, approximately 50% humidity. This superheat varies when conditions vary from the conditions described.

A superheat charge chart is available for other operating conditions. Use it to provide the correct superheat at the conditions the unit is being charged at.

After superheat is adjusted it is recommended to check unit sub-cooling at the condenser coil liquid line out. In most operating conditions 10 - 15°F of sub-cooling is adequate.

$$\text{SUPERHEAT} = \text{SUCTION LINE TEMP} - \text{SAT. SUCTION TEMP}$$

SATURATED SUCTION PRESSURE TEMPERATURE CHART	
Suction Pressure	Saturated Suction Temperature °F
PSIG	R-410A
50	1
52	3
54	4
56	6
58	7
60	8
62	10
64	11
66	13
68	14
70	15
72	16
74	17
76	19
78	20
80	21

$$\text{SUBCOOLING} = \text{SAT. LIQUID TEMP.} - \text{LIQUID LINE TEMP.}$$

SATURATED LIQUID PRESSURE TEMPERATURE CHART	
Liquid Pressure	Saturated Liquid Temperature °F
PSIG	R-410A
200	70
210	73
220	76
225	78
235	80
245	83
255	85
265	88
275	90
285	92
295	95
305	97
325	101
355	108
375	112
405	118

## SYSTEMS SUPERHEAT

SUPERHEAT CAN BE DETERMINED AS FOLLOWS:

1. Read suction pressure. Determine Saturated Suction Temperature from tables or pressure gauge saturated temperature scale (R-410A).
2. Read suction line temperature.
3. Use the following formula:

$$\text{SUPERHEAT} = \text{SUCTION LINE TEMP} - \text{SAT. SUCTION TEMP}$$

## ELECTRICAL ADJUSTMENTS

This series of electric cooling and, heat pump package equipment is designed to accept a field installed electric heat kit. The unit is equipped to easily install the HKR Series Electric Heat Kit. Full Installation Instructions are included in this kit. Please use this document for guidance in field equipping the package unit with electric heat.

Choose the heat kit that fits the application for the specific installation. Permanently mark the unit's nameplate with the model being installed. High and low voltage connections are detailed in the heat kit instructions.

Indoor Blower motor speed tap selection may need to be modified to accommodate normal continuous operation to prevent a nuisance trip. See following table.

Unit Model Number	Electric Heat KW				
	5	8	10	15	20
GPH1324M41**	M <sub>(F)</sub>	M <sub>(F)</sub>	M <sub>(F)</sub>	H	NA
GPH1330M41**	M <sub>(F)</sub>	M <sub>(F)</sub>	M <sub>(F)</sub>	H	NA
GPH/GPC1336M41**	M	M	H <sub>(F)</sub>	H <sub>(F)</sub>	NA
GPH1342M41**	M	M	H <sub>(F)</sub>	H <sub>(F)</sub>	NA
GPH/GPC1348M41**	3 <sub>(F)</sub>	3 <sub>(F)</sub>	3 <sub>(F)</sub>	3 <sub>(F)</sub>	3 <sub>(F)</sub>
GPH/GPC1360M41**	3 <sub>(F)</sub>	3 <sub>(F)</sub>	3 <sub>(F)</sub>	3 <sub>(F)</sub>	3 <sub>(F)</sub>

GPC1336M43**	---	---	---	H <sub>(F)</sub>	NA
GPC1348M43**	---	---	---	3 <sub>(F)</sub>	3 <sub>(F)</sub>
GPC1360M43**	---	---	---	3 <sub>(F)</sub>	3 <sub>(F)</sub>

\*(F) - Factory Setting

Speed Taps Description: H / 4, 5 - High; M / 2, 3 - Medium; L / 1 - Low

3 speed (H)igh/(M)edium/(L)ow: PSC motor

4 speed (H)igh/(ML)Medium Low/ (MH) Medium High/(L)ow: PSC motor

1/2/3/4/5: X-13 motor

## MAINTENANCE

**WARNING**

**HIGH VOLTAGE!**  
DISCONNECT ALL POWER BEFORE SERVICING OR INSTALLING THIS UNIT. MULTIPLE POWER SOURCES MAY BE PRESENT. FAILURE TO DO SO MAY CAUSE PROPERTY DAMAGE, PERSONAL INJURY OR DEATH.



The Self Contained Package Air Conditioner and Heat Pump should operate for many years without excessive service calls if the unit is installed properly. However it is recommended that the homeowner inspect the unit before a seasonal start up. The coils should be free of debris so adequate airflow is achieved. The return and supply registers should be free of any obstructions. The filters should be cleaned or replaced. These few steps will help to keep the product up time to a maximum. The Troubleshooting Chart (on page 11) should help in identifying problems if the unit does not operate properly.

## SERVICE

THE FOLLOWING INFORMATION IS FOR USE BY QUALIFIED SERVICE AGENCY ONLY: OTHERS SHOULD NOT ATTEMPT TO SERVICE THIS EQUIPMENT.

### Common Causes of Unsatisfactory Operation of Heat Pump on the Heating Cycle.

#### ***INADEQUATE AIR VOLUME THROUGH INDOOR COIL***

When a heat pump is in the heating cycle, the indoor coil is functioning as a condenser. The return air filter must always be clean, and sufficient air volume must pass through the indoor coil to prevent excessive discharge pressure, and high pressure cut out.

#### ***OUTSIDE AIR INTO RETURN DUCT***

Do not introduce cold outside air into the return duct of a heat pump installation. Do not allow air entering the indoor coil to drop below 65° F. Air below this temperature will cause low discharge pressure, thus low suction pressure, and excessive defrost cycling resulting in low heating output. It may also cause false defrosting.

#### ***UNDERCHARGE***

An undercharged heat pump on the heating cycle will cause low discharge pressure resulting in low suction pressure and frost accumulation on the outdoor coil.

#### ***POOR "TERMINATING" SENSOR CONTACT***

The unit's defrost terminating sensor must make good thermal contact with the outdoor coil tubing. Poor contact may not terminate the unit's defrost cycle quickly enough to prevent the unit from cutting out on high discharge pressure.

#### ***MALFUNCTIONING REVERSING VALVE - THIS MAY BE DUE TO:***

1. **Solenoid not energized** - In order to determine if the solenoid is energized, touch the nut that holds the solenoid cover in place with a screwdriver. If the nut magnetically holds the screwdriver, the solenoid is energized and the unit is in the cooling cycle.
2. **No voltage at unit's solenoid** - Check unit voltage. If no voltage, check wiring circuit.
3. **Valve will not shift:**
  - a. **Undercharged** - check for leaks;
  - b. **Valve Body Damaged** - Replace valve;
  - c. **Unit Properly Charged** - If it is on the heating cycle, raise the discharge pressure by restricting airflow through the indoor coil. If the valve does not shift, tap it **lightly** on both ends with a screwdriver handle. **DO NOT TAP THE VALVE BODY.** If the unit is on the cooling cycle, raise the discharge pressure by restricting airflow through the outdoor coil. If the valve does not shift after the above attempts, cut the unit off and wait until the discharge and suction pressure equalize, and repeat above steps. If the valve does not shift, replace it.

## TROUBLESHOOTING CHART



### WARNING

#### HIGH VOLTAGE!

**DISCONNECT ALL POWER BEFORE SERVICING OR INSTALLING THIS UNIT. MULTIPLE POWER SOURCES MAY BE PRESENT. FAILURE TO DO SO MAY CAUSE PROPERTY DAMAGE, PERSONAL INJURY OR DEATH.**



SYMPTOM	POSSIBLE CAUSE	REMEDY
High head - low suction	a. Restriction in liquid line or flowrator	a. Remove or replace with proper size flowrator.
High head - high or normal suction	a. Dirty condenser coil b. Overcharged c. Condenser fan not running	a. Clean coil. b. Correct System charge. c. Repair or Replace.
Low head - high suction	a. Incorrect flowrator b. Defective compressor valves c. Flowrator not seating properly  d. Defective reversing valve	a. Replace with correct flowrator. b. Replace compressor. c. Check for debris under flowrator or deformed flowrator. Remove debris or replace flowrator. d. Replace reversing valve.
Unit will not run	a. Power off or loose electrical connection  b. Thermostat out of calibration set too high c. Defective contactor  d. Blown fuses or tripped breaker  e. Transformer defective f. High or low pressure control open (Optional)  g. Compressor overload contacts open	a. Check for unit voltage at contactor in unit.  b. Reset. c. Check for 24 volts at contactor coil replace if contacts are open. d. Replace fuse or reset breaker.  e. Check wiring - replace transformer. f. Reset high pressure control or check unit charge.  High pressure control opens at 610 psig. Low pressure control opens at 22 psig. g. Replace compressor. NOTE: Wait at least 2 hours for overload to reset.
Condenser fan runs, compressor doesn't	a. Loose connection  b. Compressor stuck, grounded or open winding open internal overload c. Low voltage connection  d. Capacitor weak, open, or shorted	a. Check for unit voltage at compressor check & tighten all connections. b. Wait at least 2 hours for overload to reset If still open, replace the compressor. c. At compressor terminals, voltage must be within 10 % of nameplate volts when unit is operating. d. Check capacitor. If defective, replace.
Low suction - cool compressor Iced evaporator coil	a. Low indoor airflow	a. Increase speed of blower or reduce restriction - replace air filters.
Compressor short cycles	a. Defective overload protector b. Unit cycling on low pressure control	a. Replace - check for correct voltage. b. Check refrigerant charge and / or airflow.
Registers sweat	a. Low airflow	a. Increase speed of blower or reduce restriction replace air filters.
High suction pressure	a. Excessive load b. Defective compressor c. Reversing valve not seating properly.	a. Recheck load calculation. b. Replace. c. Replace.
Insufficient cooling	a. Improperly sized unit b. Improper airflow  c. Incorrect refrigerant charge.  d. Incorrect voltage	a. Recalculate load. b. Check - should be approximately 400 CFM per ton. c. Charge per procedure attached to unit service panel. d. At compressor terminals, voltage must be within 10% of nameplate volts when unit is operating.



# APPENDIX

## UNIT DIMENSIONS

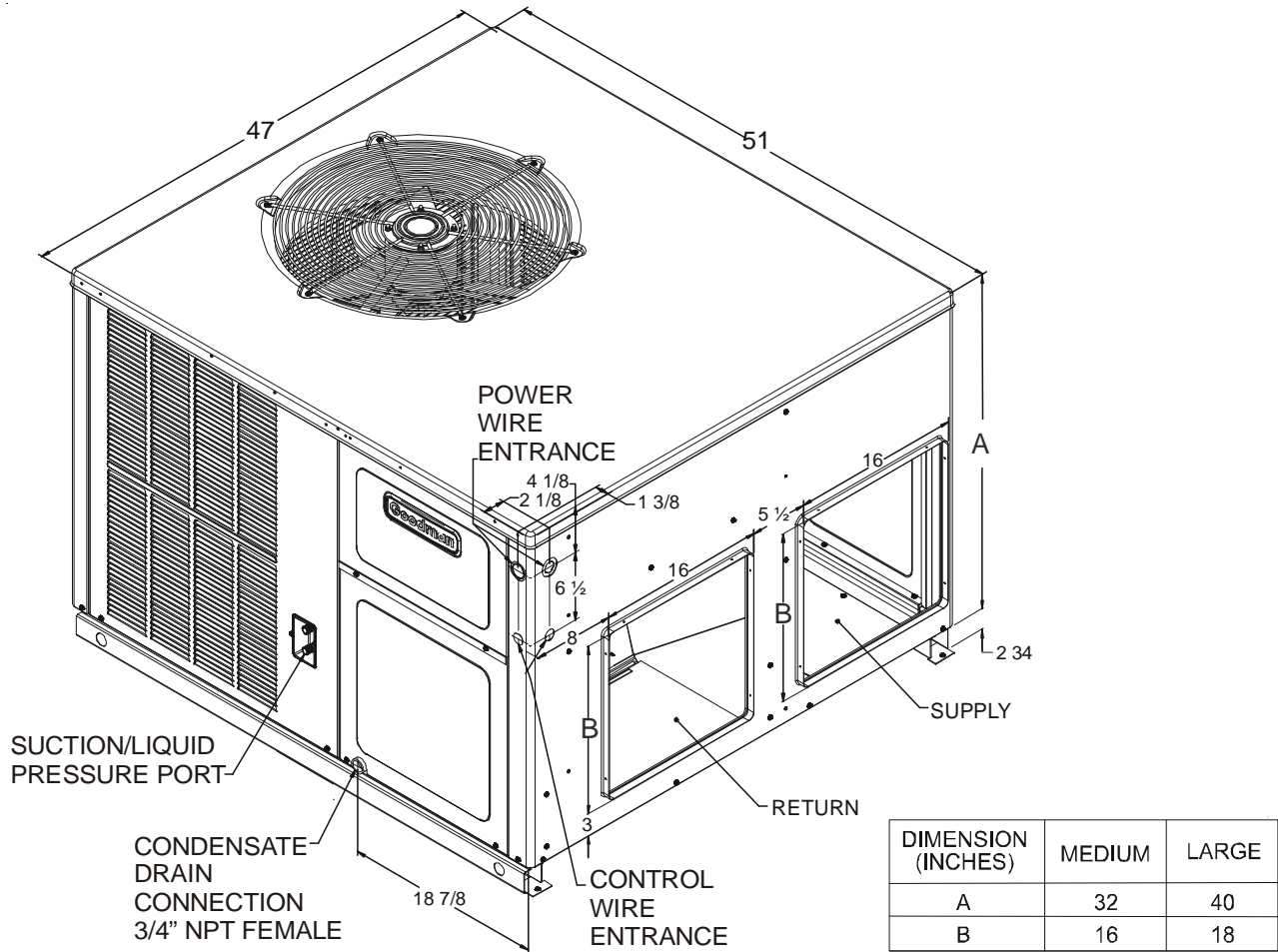

- MEDIUM CHASSIS**
- GP\*1324M4\*\*
  - GP\*1330M4\*\*
  - GP\*1336M4\*\*
  - GP\*1342M4\*\*
- LARGE CHASSIS**
- GP\*1348M4\*\*
  - GP\*1360M4\*\*

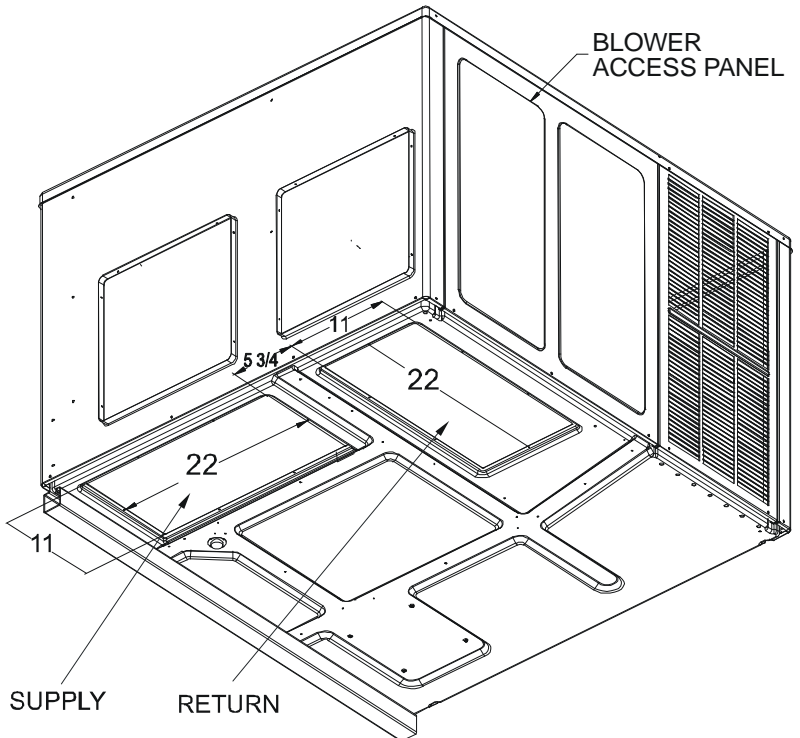

## MINIMUM CLEARANCES

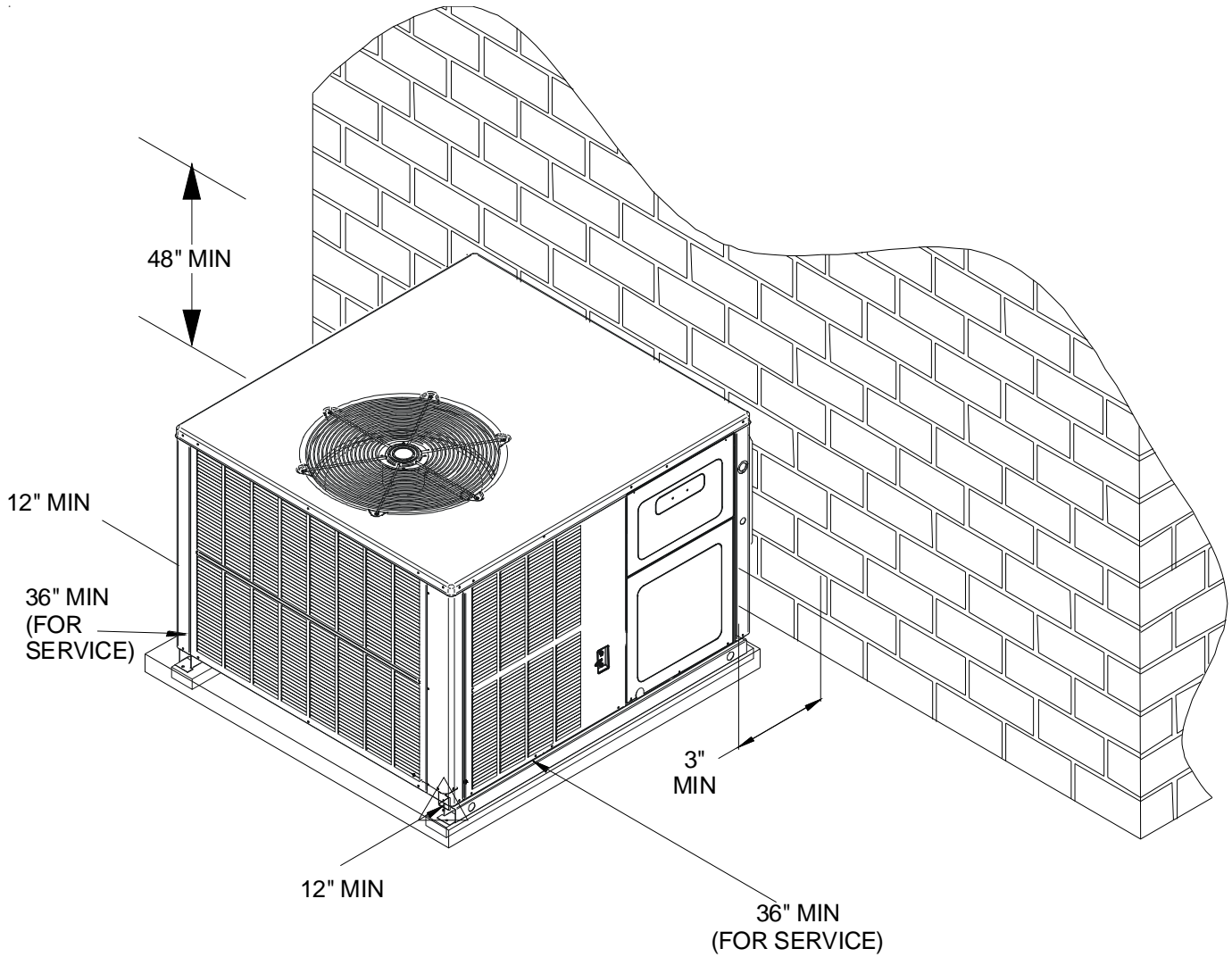

NOTE: Roof overhand should be no more than 36"

## RECOMMENDED FILTER SIZES

UNIT	2 ton	2-1/2 ton	3 ton	3-1/2 ton	4 ton	5 ton
Min. Filter Size	(1) 25x25x1	(1) 25x25x1	(1) 25x25x1	(1) 25x25x1	(2) 20x20x1	(2) 20x20x1

Goodman Manufacturing Company, L.P.  
 5151 San Felipe, Suite 500, Houston, TX 77056  
[www.goodmanmfg.com](http://www.goodmanmfg.com)    [www.amana-hac.com](http://www.amana-hac.com)  
 © 2010 Goodman Manufacturing Company, L.P.