



HP w19 LCD Monitor User's Guide

- [Preface](#)
- [Safety and Maintenance Guidelines](#)
- [Setup](#)
- [Using the Monitor](#)
- [Drivers and Auto-Adjustment](#)
- [Technical Support FAQ](#)
- [Specifications](#)
- [LCD Monitor Quality and Pixel Policy](#)
- [Agency Regulatory Notices](#)

The only warranties for HP products and services are set forth in the express warranty statements accompanying such products and services. Nothing herein should be construed as constituting an additional warranty. HP shall not be liable for technical or editorial errors or omissions contained herein.

HP assumes no responsibility for the use or reliability of its software on equipment that is not furnished by HP.

This document contains proprietary information that is protected by copyright. No part of this document may be photocopied, reproduced, or translated to another language without the prior written consent of HP.

Hewlett-Packard Company
P.O. Box 4010
Cupertino, CA 95015-4010
USA

Copyright © 2006 Hewlett-Packard Development Company, L.P.

Microsoft and Windows are U.S. registered trademarks of Microsoft Corporation.

Adobe and Acrobat are trademarks of Adobe Systems Incorporated.

Bluetooth is a trademark owned by its proprietor and used by Hewlett-Packard Company under license.

HP supports lawful use of technology and does not endorse or encourage the use of its products for purposes other than those permitted by copyright law.

The information in this document is subject to change without notice.

Part number: 431053-002

[Back to Contents Page](#)

Preface: HP w19 LCD Monitor

[About This Guide](#) • [Notational Conventions](#)

About This Guide

This guide is intended for anyone who uses the HP w19 LCD Monitor. It describes the monitor's features, setup, and operation.

The sections are as follows:

- [Safety and Maintenance Guidelines](#)
- [Setup](#)
- [Using the Monitor](#)
- [Drivers and Auto-Adjustment](#)
- [Technical Support FAQ](#)
- [Specifications](#)
- [LCD Monitor Quality and Pixel Policy](#)
- [Agency Regulatory Notices](#)

Notational Conventions

The following subsections describe notational conventions used in this document.

Notes, Cautions, and Warnings

Throughout this guide, blocks of text may be accompanied by an icon and printed in bold type or in italic type. These blocks are notes, cautions, and warnings, and they are used as follows:



NOTE: A NOTE indicates important information that helps you make better use of your computer system.



CAUTION: A CAUTION indicates either potential damage to hardware or loss of data and tells you how to avoid the problem.



WARNING: A WARNING indicates the potential for bodily harm and tells you how to avoid the problem.

Some warnings may appear in alternate formats and may be unaccompanied by an icon. In such cases, the specific presentation of the warning is mandated by regulatory authority.

[Back to Contents Page](#)

Safety and Maintenance Guidelines: HP w19 LCD Monitor

[Important Safety Information](#) • [Safety Precautions](#) • [Maintenance Guidelines](#) • [Cleaning the Monitor](#)

Important Safety Information

The power cord is designed for use with your monitor. To use a different cord, use only a power source and connection compatible with this monitor. For information on the correct power cord set to use with your monitor, see [Power Cord Set Requirements](#).



WARNING: To reduce the risk of electric shock or damage to your equipment, do not disable the power cord grounding feature. The grounding plug is an important safety feature. Connect the equipment to a grounded (earthed) power outlet.



WARNING: For your safety, be sure that the grounded power outlet you plug the power cord into is easily accessible to the operator and located as close to the equipment as possible. To disconnect power from the equipment, unplug the power cord from the power outlet by grasping the plug firmly. Never pull on the cord.



CAUTION: To protect your monitor, as well as your PC, connect all power cords for your PC and its peripheral devices (such as a monitor, printer, or scanner) to a surge protection device such as a power strip with surge protection or uninterruptible power supply (UPS).

Not all power strips provide surge protection; the power strips must be specifically labeled as having this ability. Use a power strip whose manufacturer offers a damage replacement policy so you can replace your equipment if surge protection fails.

Safety Precautions

- Avoid applying pressure to the LCD screen; doing so can cause damage.
- Use only a power source and connection compatible with this monitor, as indicated on the label/back plate of the monitor.
- Be sure the total ampere rating of the products connected to the outlet does not exceed the current rating of the electrical outlet, and the total ampere rating of the products connected to the cord does not exceed the rating of the cord. Look on the power label to determine the ampere rating (Amps or A) for each device.
- Install your monitor near an outlet that you can easily reach. Disconnect the monitor by grasping the plug firmly and pulling it from the outlet. Never disconnect the monitor by pulling the cord.
- Do not allow anything to rest on the power cord. Do not walk on the cord.

Maintenance Guidelines

To enhance the performance and extend the life of your monitor:

- Do not open your monitor cabinet or attempt to service this product yourself. If your monitor is not operating properly or has been dropped or damaged, contact your HP authorized dealer, reseller, or service provider.
- Adjust only those controls that are described in the operating instructions.
- Turn your monitor off when not in use. You can substantially increase the life expectancy of your monitor by using a screen saver and turning off the monitor when not in use.
- Keep your monitor in a well-ventilated area, away from excessive light, heat, or moisture.
- Slots and openings in the cabinet are provided for ventilation. These openings must not be blocked or covered. Never push objects of any kind into cabinet slots or other openings.
- Unplug your monitor from the wall outlet before cleaning.
- Do not drop your monitor or place it on an unstable surface.
- When removing the monitor pedestal base, you must lay the monitor face down on a soft area to prevent it from getting scratched, defaced, or broken.

Cleaning the Monitor

The monitor is a high-quality optical device that requires special care when cleaning. To clean the monitor, follow these steps:

- 1 Turn off the PC and the monitor.
- 2 Unplug your monitor from the wall outlet before cleaning.



CAUTION: Do not use benzene, thinner, ammonia, or any volatile substances to clean the monitor screen or cabinet. These chemicals may damage the monitor. Do not use liquid cleaners or aerosol cleaners. Never use water to clean an LCD screen.

- 3 Wipe the screen with a dry, soft, clean cloth.
 - If the screen requires additional cleaning, use an antistatic screen cleaner.
- 4 Dust the monitor housing. Use a damp cloth to clean the cabinet.
 - If the cabinet requires additional cleaning, use a clean cloth dampened with isopropyl alcohol.
- 5 Plug in the monitor.
- 6 Turn on the monitor and the PC.

[Back to Contents Page](#)

Setup: HP w19 LCD Monitor

- [Base](#)
 - [Attaching the Cables](#)
 - [Attaching Wall Mounting Arm](#)
-

[Back to Contents Page](#)

Base: HP w19 LCD Monitor

[Base](#) • [Attaching the Base](#) • [Removing the Base](#)

Base

- For optimal viewing it is recommended to look at the full face of the monitor, then adjust the monitor's angle to your own preference.
- Hold the stand so you do not topple the monitor when you change the monitor's angle.
- You are able to adjust the monitor's angle.

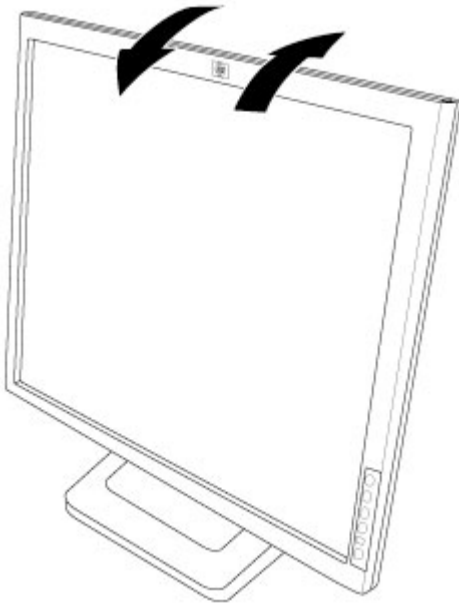

NOTE:

- Do not touch the LCD screen when you change the angle. It may cause damage or break the LCD screen.
 - Careful attention is required not to catch your fingers or hands when you change the angle.
 - The color of the cabinet may vary.
 - Outline for reference only.
-

Attaching the Base

- 1 Turn off the monitor and unplug it from the electrical outlet.
- 2 Place the base on a flat work surface.

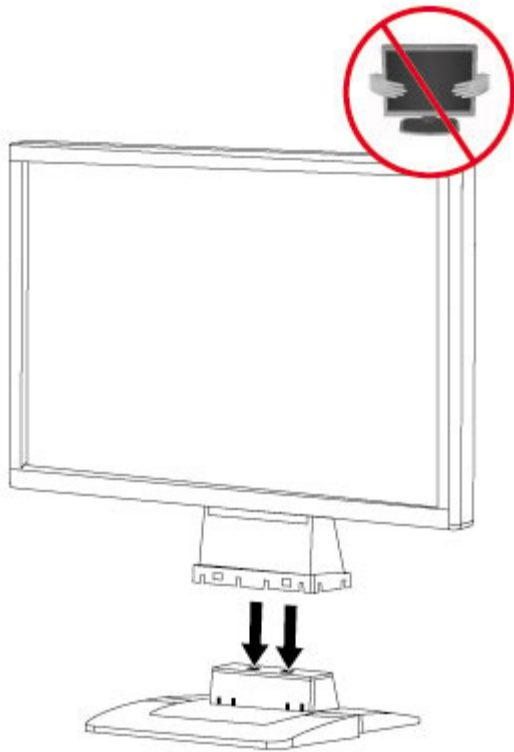

- 3 Align the tabs on the base with the corresponding slots on the bottom of the monitor.



NOTE:

- The base will align with the monitor slots in only one position.
 - The color of the cabinet may vary.
 - Outline for reference only.
-

Removing the Base

- 1 Place the monitor upside-down on a stable, flat work surface.
- 2 Push release latch on the bottom of the rear cabinet, and push the base toward the back of the monitor at the same time and lift up to remove the base.

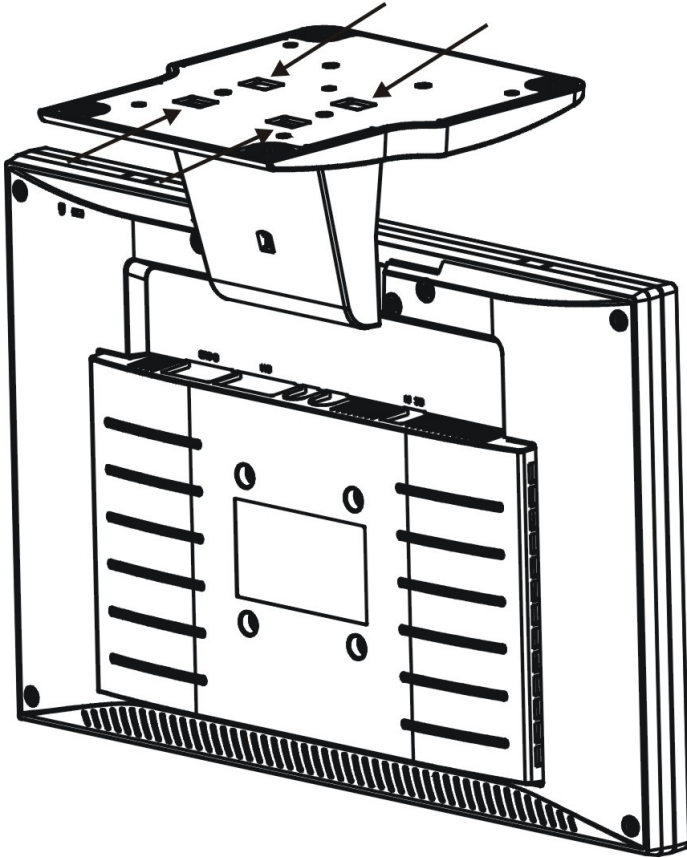

NOTE:

- The color of the cabinet may vary.
- Outline for reference only.



CAUTION: Be careful to avoid pinching or scraping fingers when removing the base.

Attaching the Cables: HP w19 LCD Monitor

Cable Connections On Back of Monitor and Computer

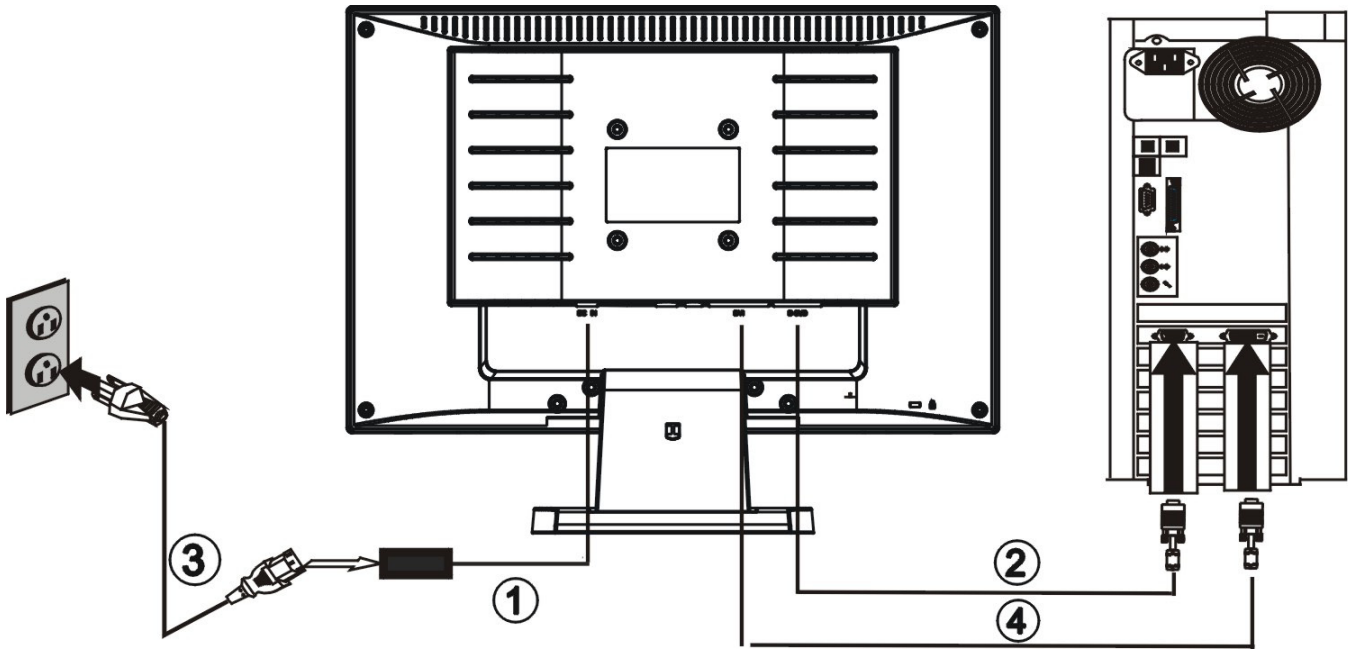

Turn off your computer before performing the procedure below.

- 1** Connect the power adapter DC cable to the DC-In port on the back of the monitor.
- 2** Connect one end of the 15-pin D-Sub (VGA) cable to the back of the monitor and connect the other end to the computer's D-Sub port.
- 3** Plug the power cable of your monitor into a nearby outlet. Plug the other end of the power cord into the power adapter.
- 4** (Optional – Requires a video card with DVI port) — Connect one end of the 24-pin DVI cable to the back of the monitor and connect the other end to the computer's DVI port.
- 5** Turn on your monitor and computer.

If your monitor displays an image, installation is complete. If it does not display an image, see [Technical Support FAQ](#) and [Using the Monitor](#).

[Back to Contents Page](#)

Attaching Wall Mounting Arm: HP w19 LCD Monitor

[Preparing to Install An Optional Wall Mounting Arm \(Not supplied\)](#) • [Installing an Optional Wall Mounting Arm \(Not supplied\)](#)

Preparing to Install An Optional Wall Mounting Arm (Not supplied)

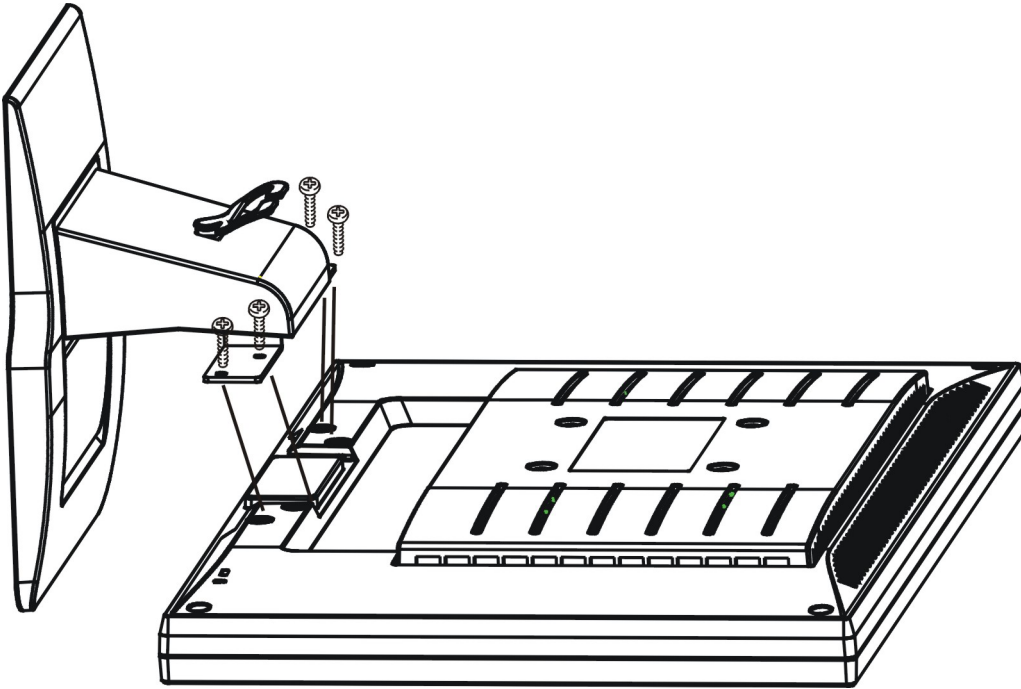

This monitor can be attached to a wall mounting arm you purchase separately. Disconnect power before this procedure. Follow these steps:

- 1** Set the monitor screen down on a flat, soft, protected surface.
- 2** Support the base and remove the screws.
- 3** Remove the base.
- 4** Follow the manufacturer's instructions to assemble the wall mounting arm.

See [Installing an Optional Wall Mounting Arm](#) for further installation instructions.

Installing an Optional Wall Mounting Arm (Not supplied)

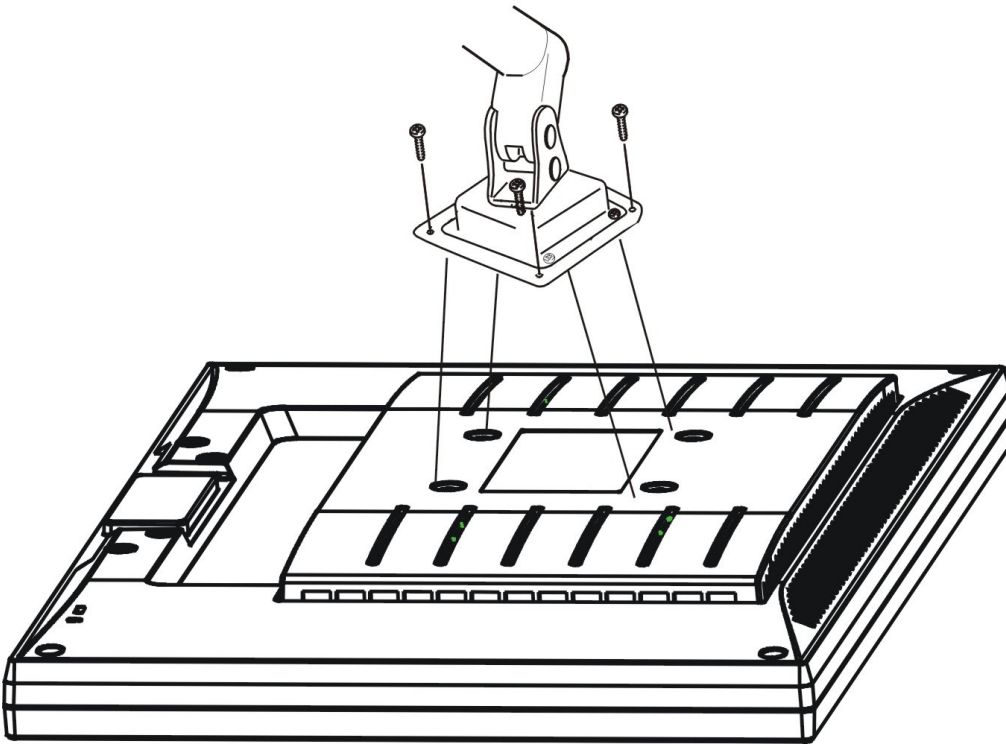

Follow these steps to finish installing a wall mounting arm (not included):

- 1** Set the monitor screen down on a flat, soft, protected surface.
- 2** Place the wall mounting arm onto the back of the monitor. Line up the holes of the arm with the holes in the back of the monitor.
- 3** Insert the 4 screws into the holes and tighten.
- 4** Reconnect the cables. Refer to the user's manual that came with the optional wall mounting arm for instructions on attaching it to the wall.

[Back to Contents Page](#)

Using the Monitor: HP w19 LCD Monitor

- [Setting the Optimal Resolution](#)
 - [Controls and Indicators](#)
-

[Back to Contents Page](#)

Setting the Optimal Resolution: HP w19 LCD Monitor

The recommended resolution for this monitor is 1440 by 900. To setup the monitor to this resolution, follow the steps below.

- 1 Click **START**.
- 2 Click **SETTINGS**.
- 3 Click **CONTROL PANEL**.
- 4 Double click **DISPLAY**.
- 5 Click **SETTINGS**.
- 6 Set the resolution **SLIDE-BAR** to 1440 by 900.



NOTE: If 1440 by 900 is not shown, download the monitor driver from the Web. See [Using the Monitor](#) for instructions.

Controls: HP w19 LCD Monitor

[Operating Instructions](#) • [External Controls](#) • [OSD Lock Function](#) • [How to Adjust a Setting](#) • [Adjusting the Picture](#) • [LED Indicators](#)

Operating Instructions

Press the power button (E) to turn the monitor on or off. The other control knobs are located at front panel of the monitor (See Figure). By changing these settings, the picture can be adjusted to your personal preferences.

- The power cord should be connected.
- Connect the video cable from the monitor to the video card.
- Press the power button (E) to turn on the monitor. The power indicator will light up.

External Controls

- A Auto Config / Exit
- B Brightness
- C Contrast
- D Menu / Enter
- E Power Button

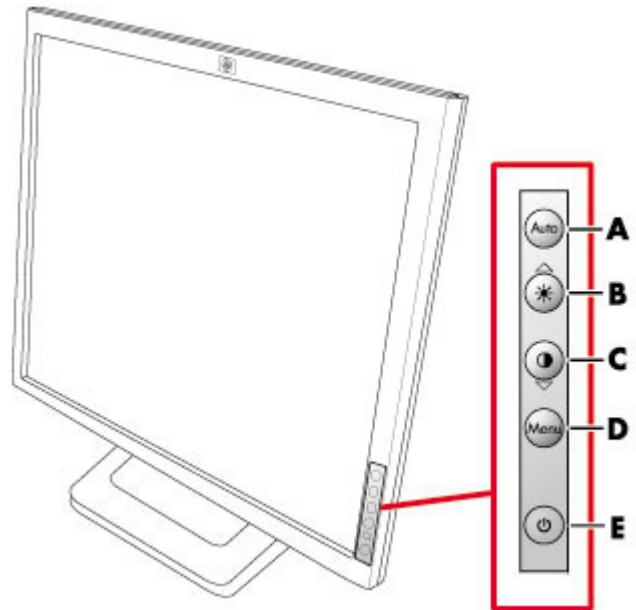

OSD Lock Function







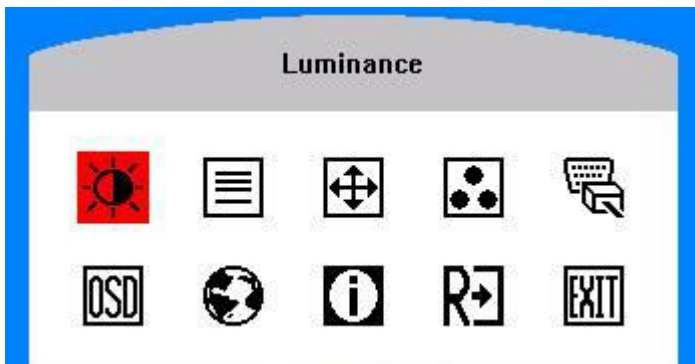











To lock the OSD, press and hold the Menu button while the monitor is off and then press power button to turn the monitor on. To un-lock the OSD — press and hold the Menu button while the monitor is off and then press power button to turn the monitor on.

How to Adjust a Setting

- 1 Press the Menu button to activate the OSD window.
- 2 Press ▲ or ▼ to navigate through the functions. Once the desired function is highlighted, press the Menu button to activate it. If the function selected has a sub-menu, press ▲ or ▼ again to navigate through the sub-menu functions. Once the desired function is highlighted, press Menu button to activate it.
- 3 Press ▲ or ▼ to change the settings of the selected function.
- 4 To exit and save, select the exit function. If you want to adjust any other function, repeat steps 2-3.



Adjusting the Picture

Main Menu Item	Main Menu Icon	Sub Menu Item	Sub Menu Icon	Description
Luminance		Contrast		Contrast from digital-register
		Brightness		Backlight adjustment
Image Setup		Focus		Adjust picture phase to reduce horizontal-line noise
		Clock		Adjust picture clock to reduce vertical-line noise
Image Position		H. Position		Adjust the horizontal position of the picture
		V. Position		Adjust the vertical position of the picture
Color Temp.		Warm	N/A	Recall warm color temperature from EEPROM
		Cool	N/A	Recall cool color temperature from EEPROM
		sRGB	N/A	Recall sRGB temperature from EEPROM
		User / Red	R	Red gain from digital-register
		User / Green	G	Green gain from digital-register.
		User / Blue	B	Blue gain from digital-register
Input Select		Analog	N/A	Select input signal from analog source (D-Sub)
		Digital	N/A	Select input signal from digital source (DVI)
OSD Setup		H. Position		Adjust the horizontal position of the OSD
		V. Position		Adjust the vertical position of the OSD
		OSD Timeout		Adjust the OSD timeout
Language		Language	N/A	Select the language you like
Information		Information	N/A	Show the resolution, H/V frequency and input port of current input timing
Reset		Yes	N/A	Clear each old status of auto-configuration
		No	N/A	Do not execute reset, return to main menu
Exit		N/A	N/A	Exit OSD

See [Specifications](#) for the horizontal and vertical scan ranges addressable by this monitor.

LED Indicators

Status	LED Color
Full Power Mode	Green
Active-off Mode	Red

See [Technical Support FAQ](#) for more information.

[Back to Contents Page](#)

Installing Drivers and Using the Auto-Adjustment Feature: HP w19 LCD Monitor

Downloading from the World Wide Web

To download the latest version of INF and ICM files from the HP Support Web site:

- 1 Refer to: <http://www.hp.com/support>
- 2 Select your country/region.
- 3 Select **Download Drivers and Software**.
- 4 Enter the model number for your monitor to go to the software download pages for your monitor.
- 5 Download and install the INF and ICM files using the instructions in the download pages.

Using the Auto-Adjustment Function

You can easily optimize the screen performance for the VGA (analog) input by using the Auto button on the monitor.

Do not use this procedure if your monitor is using a DVI input. If your monitor is using a VGA (analog) input, this procedure can correct the following image quality conditions:

- Fuzzy or unclear focus
- Ghosting, streaking, or shadowing effects
- Faint vertical bars
- Thin, horizontal scrolling lines
- An off-center picture

Technical Support FAQ: HP w19 LCD Monitor

Technical Support FAQ (Frequently Asked Questions)

Problem & Question	Possible Solutions
Power LED is not on	<ul style="list-style-type: none">• Make sure the power button is on and the power cord is properly connected to a grounded power outlet and to the monitor.
No Plug & Play	<ul style="list-style-type: none">• In order for the Plug & Play feature of the monitor to work, you need a Plug & Play compatible computer and video card. Check with your computer manufacturer. Also check the monitor's video cable and make sure none of the pins are bent.• Make sure the HP monitor drivers are installed (HP monitor drivers are available at: http://www.hp.com/support).
Picture is fuzzy and has ghosting shadowing problem	<ul style="list-style-type: none">• Adjust the contrast and brightness controls.• Make sure you are not using an extension cable or switch box. We recommend plugging the monitor directly to the video card output connector on the back of your computer.
Picture bounces, flickers or wave pattern is present in the picture	<ul style="list-style-type: none">• Move electrical devices that may cause electrical interference as far away from the monitor as possible.• Use the maximum refresh rate your monitor is capable of at the resolution you are using.
Monitor is stuck in "Active Off-Mode"	<ul style="list-style-type: none">• The computer power switch should be in the on position.• The computer video card should be snugly seated in its slot.• Make sure the monitor's video cable is properly connected to the computer.• Inspect the monitor's video cable and make sure none of the pins are bent.• Make sure your computer is operational by hitting the Caps Lock key on the keyboard while observing the Caps Lock LED. The LED should either turn on or off after hitting the Caps Lock key.
Missing one of the primary colors (red, green, or blue)	<ul style="list-style-type: none">• Inspect the monitor's video cable and make sure that none of the pins are bent.• Make sure the monitor's video cable is properly connected to the computer.
Screen image is not centered or sized properly	<ul style="list-style-type: none">• Adjust H-Position and V-Position or press hot-key (Auto)
Picture has color defects (white does not look white)	<ul style="list-style-type: none">• Adjust RGB color or select color temperature

[Back to Contents Page](#)

Specifications: HP w19 LCD Monitor

[General](#) • [LCD Panel \(19"\)](#) • [Resolution](#) • [Preset Display Modes](#) • [Environmental](#) • [Physical Characteristics](#) • [Power Cord Set Requirements](#) • [Pin Assignments](#) • [Plug and Play DDC2B Feature](#)

All specifications represent the typical specifications provided by HP's component manufacturers; actual performance may vary either higher or lower.

General

Model number	HP w19
--------------	--------

LCD Panel (19")

Driving system	TFT Color LCD
Size	48cm(19.0")
Pixel pitch	0.285mm(H) x 0.285mm(V)
Viewable angle	150° (H) 130°(V)
Video	R, G, B Analog Interface & Digital Interface
Separate Sync.	H/V TTL & TMDS
Display Color	16.2 million Colors
Dot Clock	135MHz

Resolution

Horizontal scan range	30 kHz to 83 kHz
Horizontal scan size (Maximum)	410mm
Vertical scan range	55 Hz to 75 Hz
Vertical scan size (Maximum)	256mm
Optimal preset resolution	1440 x 900 at 60 Hz
Highest preset resolution	1440 x 900 at 60 Hz
Highest addressable resolution	1440 x 900 at 60 Hz
Plug & Play	VESA DDC2B
Input Connector	D-Sub 15pin & DVI-D
Input Video Signal	Analog: 0.7Vp-p(standard), 75 OHM, Positive & DVI-D Digital Interface (TMDS)
Power Source	100~240VAC, 47~63Hz

Preset Display Modes

Standard	Resolution	Horizontal Frequency (kHz)	Vertical Frequency (Hz)
Dos-mode	720 x 400	31.47	70.0
VGA	640 x 480	31.47	60.0
VGA	640 x 480	37.50	75.0
SVGA	800 x 600	37.879	60.0
SVGA	800 x 600	46.875	75.0
XGA	1024 x 768	48.363	60.0
XGA	1024 x 768	56.476	70.0
XGA	1024 x 768	60.02	75.0
SXGA	1280 x 1024	64.00	60.0
SXGA	1280 x 1024	80.00	75.0
WXGA+	1440 x 900	55.935	59.8

Physical Characteristics

Connector Type	15-pin Mini D-Sub & DVI-D
Signal Cable Type	Detachable
Dimensions & Weight:	
Height (with base)	14.02 inches (356 mm)
Width	17.32 inches (440 mm)
Depth	8.46 inches (215 mm)
Weight (monitor only)	9.3 lb (4.2 kg)
Weight (with packaging)	12.8 lb (5.8 kg)

Environmental

Temperature:	
Operating	0° to +40°
Non-Operating	-20° to +60°
Humidity:	
Operating	15% to 90% (non-condensing)
Non-Operating	15% to 90% (non-condensing)
Altitude:	
Operating	0~3658m (0~12000 ft)
Non-Operating	0~12192m (0~40000 ft)

Power Cord Set Requirements

The monitor power supply is provided with automatic line switching (ALS). This feature allows the monitor to operate on input voltages between 100–120V \sim or 200–240V \sim .

The power cord set (flexible cord or wall plug) received with the monitor meets the requirements for use in the country/region where you purchased the equipment.

If you need to obtain a power cord for a different country/region, you should purchase a power cord that is approved for use in that country/region.

The power cord must be rated for the product and for the voltage and current marked on the product's electrical ratings label. The voltage and current rating of the cord should be greater than the voltage and current rating marked on the product. In addition, the cross-sectional area of the wire must be a minimum of 0.75 mm² or 18AWG, and the length of the cord must be between 4.94 ft. (1.5 m) and 12 ft. (3.6 m). If you have questions about the type of power cord to use, contact your HP-authorized service provider.

A power cord should be routed so that it is not likely to be walked on or pinched by items placed upon it or against it. Particular attention should be paid to the plug, electrical outlet, and the point where the cord exits from the product.

Pin Assignments

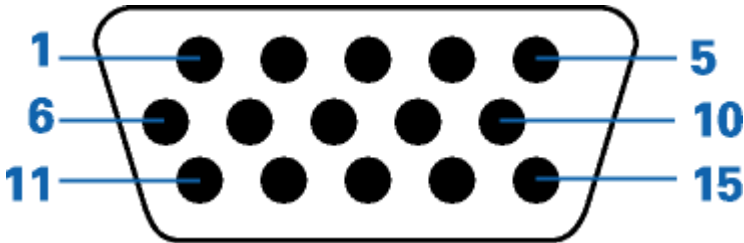

Pin Number	15-Pin Side of the Signal Cable
1	Video-Red
2	Video-Green
3	Video-Blue
4	Ground
5	Ground
6	GND-R
7	GND-G
8	GND-B
9	+5V
10	Detect Cable
11	Ground
12	DDC-Serial data
13	H-sync
14	V-sync
15	DDC-Serial clock

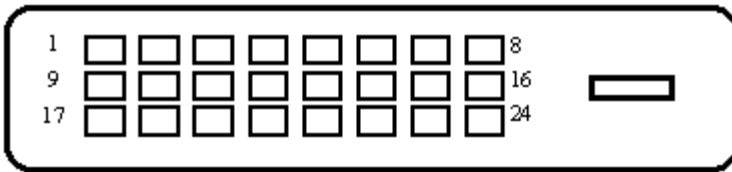

Pin No.	Signal Name	Pin No.	Signal Name	Pin No.	Signal Name
1	TMDS Data 2-	9	TMDS Data 1-	17	TMDS Data 0-
2	TMDS Data 2+	10	TMDS Data 1+	18	TMDS Data 0+
3	TMDS Data 2/4 Shield	11	TMDS Data 1/3 Shield	19	TMDS Data 0/5 Shield
4	TMDS Data 4-	12	TMDS Data 3-	20	TMDS Data 5-
5	TMDS Data 4+	13	TMDS Data 3+	21	TMDS Data 5+
6	DDC Clock	14	+5V Power	22	TMDS Clock Shield
7	DDC Data	15	Ground (for +5V)	23	TMDS Clock+
8	N.C.	16	Hot Plug Detect	24	TMDS Clock-

Plug and Play DDC2B Feature

Plug & Play DDC2B Feature

This monitor is equipped with VESA DDC2B capabilities according to the VESA DDC STANDARD. It allows the monitor to inform the host system of its identity and, depending on the level of DDC used, communicate additional information about its display capabilities.

The DDC2B is a bi-directional data channel based on the I²C protocol. The host can request EDID information over the DDC2B channel.

[Back to Contents Page](#)

LCD Monitor Quality and Pixel Policy: HP w19 LCD Monitor

The HP LCD Monitor uses high-precision technology, manufactured according to high standards, to help guarantee trouble-free performance. Nevertheless, the display may have cosmetic imperfections that appear as small bright or dark spots. This is common to all LCD displays used in products supplied by all vendors and is not specific to the HP LCD Monitor. These imperfections are caused by one or more defective pixels or subpixels.

- A pixel consists of one red, one green, and one blue subpixel.
- A defective whole pixel is always turned on (a bright spot on a dark background), or it is always off (a dark spot on a bright background). The first is the more visible of the two.
- A defective subpixel (dot defect) is less visible than a defective whole pixel and is small and only visible on a specific background.

To locate defective pixels, the monitor should be viewed under normal operating conditions and in normal operating mode at a supported resolution and response rate, from a distance of approximately 50 cm (16 in).

We expect that, over time, the industry will continue to improve its ability to produce displays with fewer cosmetic imperfections, and we will adjust guidelines as improvements are made.

For more information about your HP w19 LCD Monitor, refer to the HP Web site at: <http://www.hp.com/support>

Agency Regulatory Notices: HP w19 LCD Monitor

Federal Communications Commission Notice

This equipment has been tested and found to comply with the limits for a Class B digital device, pursuant to Part 15 of the FCC Rules. These limits are designed to provide reasonable protection against harmful interference in a residential installation. This equipment generates, uses, and can radiate radio frequency energy and, if not installed and used in accordance with the instructions, may cause harmful interference to radio communications. However, there is no guarantee that interference will not occur in a particular installation. If this equipment does cause harmful interference to radio or television reception, which can be determined by turning the equipment off and on, the user is encouraged to try to correct the interference by one or more of the following measures:

- Reorient or relocate the receiving antenna.
- Increase the separation between the equipment and the receiver.
- Connect the equipment into an outlet on a circuit different from that to which the receiver is connected.
- Consult the dealer or an experienced radio or television technician for help.

Modifications

The FCC requires the user to be notified that any changes or modifications made to this device that are not expressly approved by Hewlett-Packard Company may void the user's authority to operate the equipment.

Cables

Connections to this device must be made with shielded cables with metallic RFI/EMI connector hoods to maintain compliance with FCC rules and regulations.

Declaration of Conformity for Products Marked with FCC Logo, United States Only

This device complies with Part 15 of the FCC Rules. Operation is subject to the following two conditions: (1) this device may not cause harmful interference, and (2) this device must accept any interference received, including interference that may cause undesired operation.

For questions regarding your product, contact:

Hewlett-Packard Company
P. O. Box 692000, Mail Stop 530113
Houston, Texas 77269-2000
Or
call: 1-(800)-474-6836

For questions regarding this FCC declaration, contact:

Hewlett-Packard Company
P. O. Box 692000, Mail Stop 510101
Houston, Texas 77269-2000
Or
call: 1-(281)-514-3333

To identify this product, refer to the part, series, or model number found on the product.

Canadian Notice

This Class B digital apparatus meets all requirements of the Canadian Interference-Causing Equipment Regulations.

Avis Canadien

Cet appareil numérique de la classe B respecte toutes les exigences du Règlement sur le matériel brouilleur du Canada.

European Union Regulatory Notice

This product complies with the following EU directives:

- Low Voltage Directive 73/23/EEC
- EMC Directive 89/336/EEC

Compliance with these directives implies conformity to applicable harmonized European standards (European Norms) which are listed on the EU Declaration of Conformity issued by Hewlett-Packard for this product or product family.

This compliance is indicated by the following conformity marking placed on the product:

 <p>This marking is valid for non-Telecom products and EU harmonized Telecom products (e.g., Bluetooth).</p>	 <p>This marking is valid for EU non-harmonized Telecom products. *Notified body number (used only if applicable — refer to the product label).</p>
---	---

Disposal of Waste Equipment by Users in Private Households in the European Union

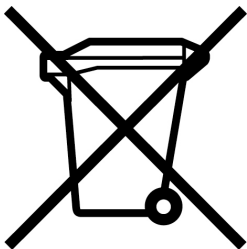

This symbol on the product or on its packaging indicates that this product must not be disposed of with your other household waste. Instead, it is your responsibility to dispose of your waste equipment by handing it over to a designated collection point for the recycling of waste electrical and electronic equipment. The separate collection and recycling of your waste equipment at the time of disposal will help to conserve natural resources and ensure that it is recycled in a manner that protects human health and the environment. For more information about where you can drop off your waste equipment for recycling, please contact your local city office, your household waste disposal service or the shop where you purchased the product.

Japanese Notice

この装置は、情報処理装置等電波障害自主規制協議会（VCCI）の基準に基づくクラスB情報技術装置です。この装置は、家庭環境で使用することを目的としていますが、この装置がラジオやテレビジョン受信機に近接して使用されると、受信障害を引き起こすことがあります。

取扱説明書に従って正しい取り扱いをして下さい。

Japanese Power Cord Notice

製品には、同梱された電源コードをお使い下さい。
同梱された電源コードは、他の製品では使用出来ません。

Korean Notice

B급 기기 (가정용 정보통신기기)

이 기기는 가정용으로 전자파적합등록을 한 기기로서
주거지역에서는 물론 모든지역에서 사용할 수 있습니다.

Materials Disposal

This HP product contains the following materials that require special handling at end-of-life:

- Mercury in the fluorescent lamp in the display LCD.
- Lead in the solder and some component leads.

Disposal of this material can be regulated because of environmental considerations. For disposal or recycling information, contact your local authorities, HP Planet Partners (<http://www.hp.com/recycle>), or the Electronic Industries Alliance (EIA) (<http://www.eiae.org>).

HP Recycling Program

HP offers product end-of-life return programs for HP and other manufacturers' hardware in several geographic areas.

The terms and availability of these programs vary by geography because of differences in regulatory requirements and local customer demand. For information on the HP recycling program, refer to the HP Web site at:

<http://www.hp.com/recycle>

EPA Energy Star Compliance



Products marked with the ENERGY STAR® logo on the packaging box qualify with the U.S. Environmental Protection Agency's ENERGY STAR® guidelines for energy efficiency.

Products with the ENERGY STAR® label are designed to use less energy, help you save money on utility bills, and help protect the environment.

ENERGY STAR® is a registered trademark owned by the U.S. government.