

Notice

Important Safety Instructions

What the f1503 Monitor Offers

What the f1703 Monitor Offers

Unpacking the Monitor

Setting Up the Monitor

Installing the Drivers

Using the Monitor

Adjusting the Monitor Settings

Troubleshooting

LCD Monitor Quality and Pixel  
Policy for f1503 Monitor

LCD Monitor Quality and Pixel  
Policy for f1703 Monitor

Technical Specifications for the  
f1503 Monitor

Technical Specifications for the  
f1703 Monitor

Care and Cleaning

Environmental Information

Regulatory Information



**hp pavilion**  
**f1503/f1703**  
**15-inch/17-inch**  
**LCD Monitor**  
(15-inch/17-inch Viewable Image)  
**User's Guide**

## *Notice*

The information contained in the documents accompanying this product is subject to change without notice.

Hewlett-Packard makes no warranty of any kind with regard to this material, including, but not limited to, the implied warranties of merchantability and fitness for a particular purpose.

HP shall not be liable for errors contained herein or for incidental or consequential damages in connection with the furnishing, performance, or use of this material.

HP assumes no responsibility for the use or reliability of its software on equipment that is not furnished by HP.

These documents contain proprietary information that is protected by copyright. All rights are reserved. No part of these documents may be photocopied, reproduced, or translated to another language without the prior written consent of HP.

Hewlett-Packard Company  
P.O. Box 4010  
Cupertino, CA 95014-4010  
USA

© 2003 Hewlett-Packard Company. All rights reserved.

Hewlett-Packard is a registered trademark of Hewlett-Packard Company in the United States of America and other countries/regions. Other brand or product names are trademarks of their respective holders.

**f1503 15-inch LCD  
Monitor**

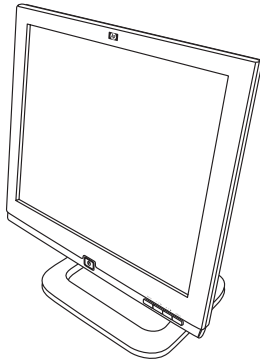

**f1703 17-inch LCD  
Monitor**

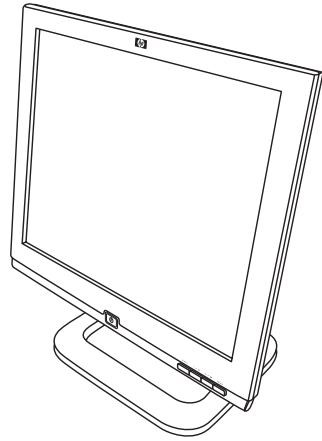

hp pavilion f1503/f1703  
15-inch/17-inch  
LCD Monitor  
(15-inch/17-inch Viewable Image)  
User's Guide

## Important Safety Instructions



---

**CAUTION:** The lightning flash with arrowhead symbol inside an equilateral triangle is intended to alert the user to the presence of uninsulated, dangerous voltage which may be of sufficient magnitude to constitute a risk of electric shock.

---



---

**WARNING:** The exclamation point within an equilateral triangle is intended to alert the user to the presence of important operating and servicing instructions in the literature accompanying the appliance.

---



---

**WARNING:** If you are unsure that you can lift the equipment safely, do not try to move it without help.

---



---

**WARNING:** Before you connect any cables or install the HP monitor, refer to the above safety instructions. Also, refer to the setup poster and the documentation included with the PC and the video adapter to ensure this equipment is correctly installed.

---



---

**WARNING:** For your safety, always connect equipment to a three-prong, grounded wall outlet. Always use a power cord with a properly grounded plug, such as the one provided with the equipment, or one in compliance with your national safety standards. This equipment can be disconnected from the power by removing the power cord from the power outlet. This means the equipment must be located close to an easily accessible power outlet.

---



---

**WARNING:** Use the monitor with the power adapter supplied with your HP monitor only.

To avoid electrical shock, do not open the monitor cover or the power adapter. There are no user-serviceable parts inside. Only qualified service personnel should service these parts.

Make sure the computer is turned off before connecting or disconnecting a display peripheral.

---

## Working in comfort

Thank you for selecting HP monitor equipment.

To optimize your comfort and productivity, it's important that you set up your work area correctly and use your HP equipment properly. With that in mind, we have developed some setup and use recommendations based on established ergonomic principles for you to follow.

These recommendations can be found in the online version of the Working in Comfort guide, which is preloaded on the hard disk of your HP computer. They can also be found on the HP Working in Comfort Web site at <http://www.hp.com/ergo> along with other information.

---

**NOTE:** *This monitor is not intended for use in an office workspace.*

---

## What the f1503 Monitor Offers

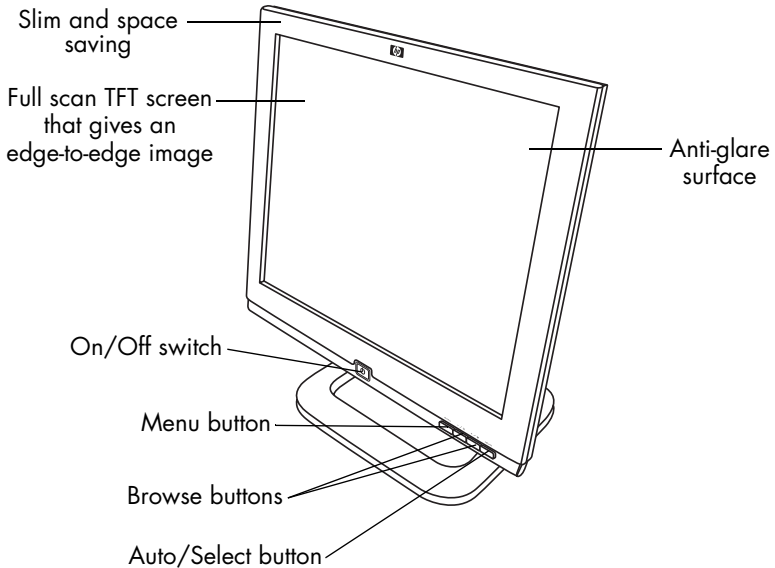

The HP f1503 monitor is a liquid crystal display (LCD) 15-inch, high resolution, multi-synchronous color monitor. *Multi-synchronous* means that the monitor can use a range of video modes. It is optimized for use with HP computers.

*The HP f1503 monitor has the following features:*

- A 15-inch LCD; thin film transistor (TFT) with an anti-glare surface
- Support of video modes up to 1024 x 768 at a 75 Hz refresh rate
- Analog VGA interface connector for connecting to the computer
- True color (16 million colors)
- Adjustable pedestal for positioning the tilt and level of the monitor screen
- Auto-adjustment of display position, clock, and phase for the VGA interface

## hp pavilion f1503/f1703 LCD Monitor

### What the f1503 Monitor Offers

---

- An On Screen Display (OSD) manager that allows you to adjust settings through onscreen menus
- Power-management system (VESA\* standard) controlled from suitably equipped HP computers to automatically reduce the power consumption of the monitor

---

**NOTE:** *As an ENERGY STAR® partner, HP has determined that this product meets ENERGY STAR guidelines for energy efficiency.*

---

- Low power consumption: 40 W maximum
- Compliance with stringent Swedish Low Emissions guidelines TCO '99
- Plug and Play capability enabling the monitor to identify itself to suitably equipped HP computers
- Slot for security lock

\* VESA is the Video Electronics Standards Association.

## What the f1703 Monitor Offers

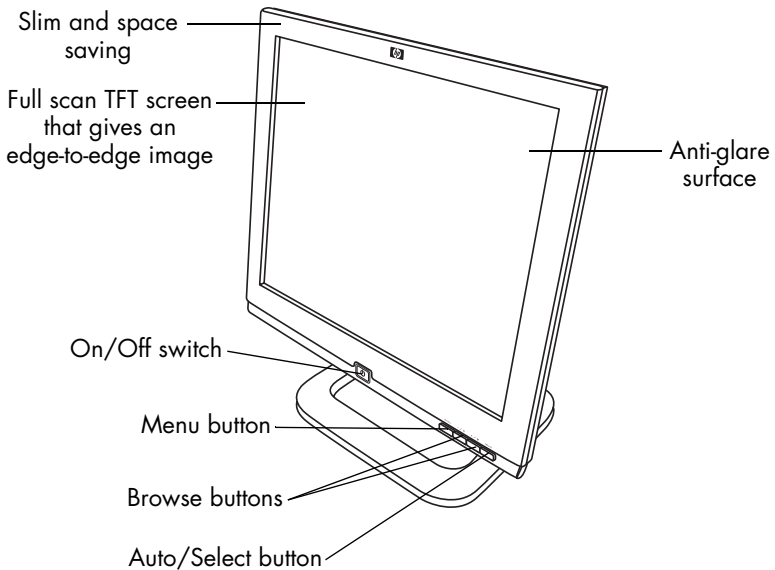

The HP f1703 monitor is a liquid crystal display (LCD) 17-inch, high resolution, multi-synchronous color monitor. *Multi-synchronous* means that the monitor can use a range of video modes. It is optimized for use with HP computers.

*The HP f1703 monitor has the following features:*

- A 17-inch LCD; thin film transistor (TFT) with an anti-glare surface
- Support of video modes up to 1280 x 1024 at a 75 Hz refresh rate
- Analog VGA interface connector for connecting to the computers
- True color (16 million colors)
- Adjustable pedestal for positioning the tilt and level of the monitor screen
- Auto-adjustment of display position, clock, and phase for the VGA interface
- An On Screen Display (OSD) manager that allows you to adjust settings through onscreen menus



## hp pavilion f1503/f1703 LCD Monitor

### What the f1703 Monitor Offers

---

- Low power consumption: 50 W maximum
- Power-management system (VESA\* standard) controlled from suitably equipped HP computers to automatically reduce the power consumption of the monitor

---

**NOTE:** *As an ENERGY STAR partner, HP has determined that this product meets ENERGY STAR guidelines for energy efficiency.*

---

- Plug and Play capability enabling the monitor to identify itself to suitably equipped HP computers
- Slot for security lock

\* VESA is the Video Electronics Standards Association.

## *Unpacking the Monitor*

Check for the following items. If they are missing or damaged, consult your retailer immediately.

- 1 liquid crystal display (LCD)
- 1 power cord
- 1 DC adapter with an attached DC cable
- 1 set of speakers with a DC cable or speaker DC power adapter
- 1 video cable (VGA)
- 1 quick setup poster
- 1 warranty booklet
- 1 CD-ROM disc

## Setting Up the Monitor

Place the monitor on a flat, sturdy surface. Ensure that the operating site is free from excessive heat and moisture. For best performance, make sure nothing is resting on the monitor.

### Connecting the power and video cables

Before you connect any cables or install the HP monitor, refer to the safety instructions at the beginning of this manual. Refer also to the documentation that came with the computer to ensure this equipment is correctly installed.

Look at the following diagram and follow the steps listed below to connect the cables to the f1503 15-inch LCD monitor or the f1703 17-inch LCD monitor.

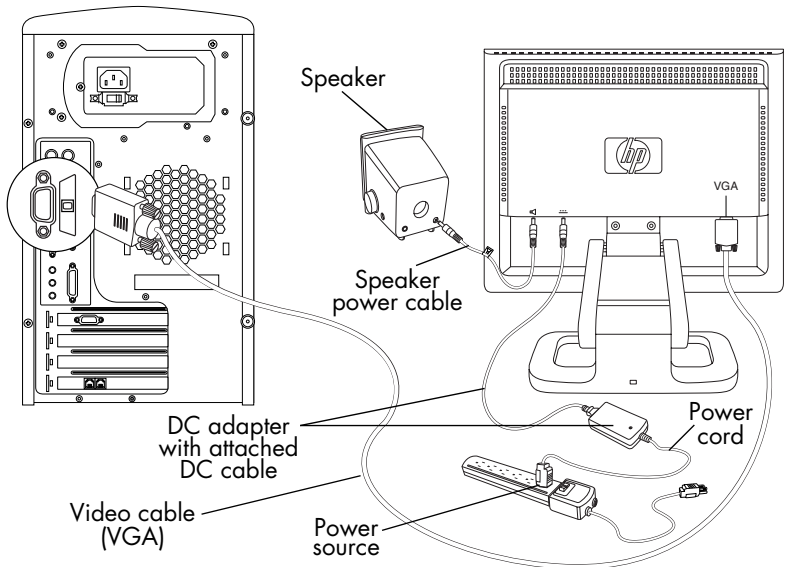

**CAUTION:** These monitors are equipped with an auto-sensing power supply for voltage ranges 100–240 V  $\sim$ , 50/60 Hz. Use the monitor with the supplied DC adapter only.

*To connect the cables to the f1503/f1703 monitor:*

- 1 Turn off the computer.
- 2 Plug the video cable into the video connector (VGA) on the back of the monitor and into the corresponding video connector on the computer. Secure the cable by tightening the thumbscrews.
- 3 Plug the DC adapter cable into the connector on the back of the monitor.
- 4 Plug the power cord into the DC adapter and into the main power source. Refer to the warnings in "Important Safety Instructions" on page 4 for power source connection requirements.
- 5 Turn on the main power source (for example, a surge protector), and then turn on the power switch for both the computer and the monitor.

*To disconnect the cables from the f1503/f1703 monitor:*

- 1 Turn off the power switch for the monitor and the computer and then turn off the main power source.
- 2 Disconnect the power cord from the main power source and from the DC adapter cable.
- 3 Disconnect the DC adapter cable from the connector at the back of the monitor.
- 4 Unscrew the thumbscrews on the video cable and disconnect the video cable.

## Connecting speakers to the monitor

The monitor is designed for use with the speakers supplied by HP. You may have two speakers, or two speakers and an optional subwoofer (not included with the monitor).

The left and right speakers sit on the desktop. The right speaker features:

- On/Volume knob
- Headphones connector
- Stereo audio cable (green plug) that plugs into the PC or the subwoofer
- Hardwired audio cable that goes to the left speaker
- Connector that accepts a subwoofer control cable
- Receptacle for the power cable

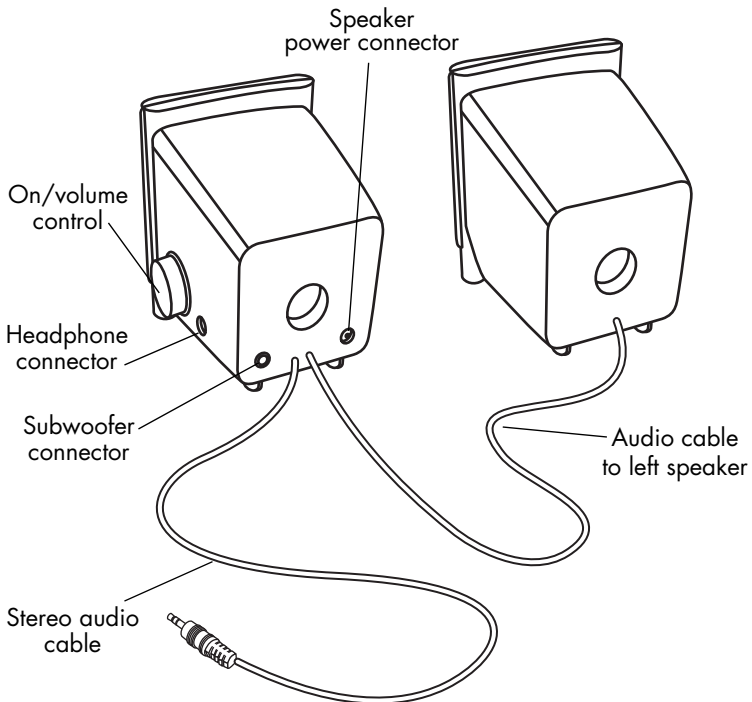

## hp pavilion f1503/f1703 LCD Monitor

### Setting Up the Monitor

The optional subwoofer sits on the desktop, or under your computer desk. The subwoofer features:

- On button (front)
- Volume knob (front)
- Audio cable (green plug) that plugs into the PC
- Control cable (purple plug) that plugs into the right speaker
- Connector (green) that accepts the right speaker stereo audio cable
- Receptacle for the power adapter cable

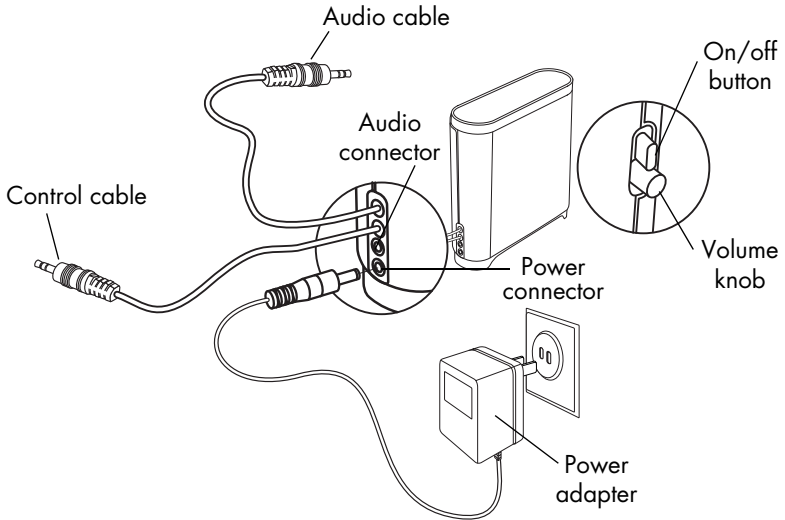

*To connect a two-speaker system (without a subwoofer):*

- 1 Place the speakers in a location near the monitor.
- 2 Connect the right speaker to the appropriate power source:
  - If the monitor came with a power cable, plug the power cable into the back of the right speaker and into the back of the monitor.

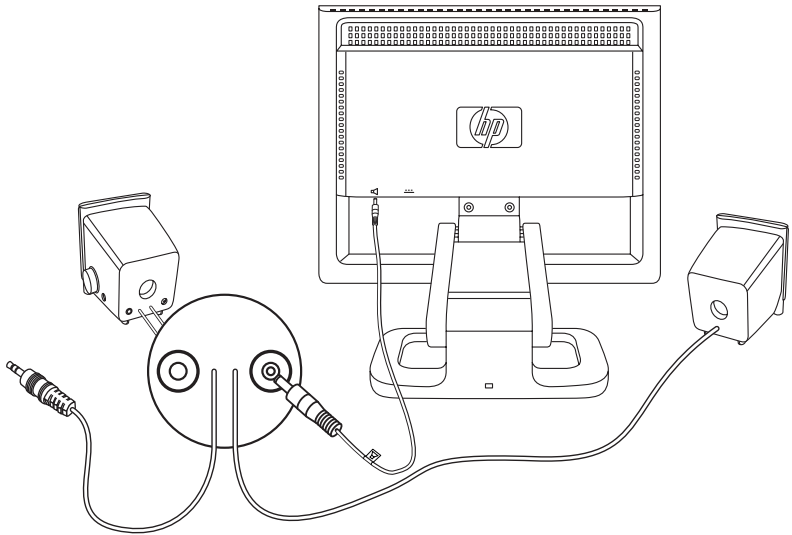

- If the monitor came with a power adapter for the speakers, plug the power adapter cable into the back of the right speaker and plug the power adapter into the main power source (for example, a surge protector).
- 3 Plug the right speaker audio cable (green plug) into the PC. Refer to your PC user's guide for instruction on how to connect your speakers to the PC.
  - 4 Turn on the PC, the monitor, and the speakers.

*To connect a two-speaker and subwoofer system:*

- 1 Place the speakers and subwoofer in the appropriate locations near the monitor.
- 2 Plug the power cable into the back of the right speaker and into the back of the monitor.

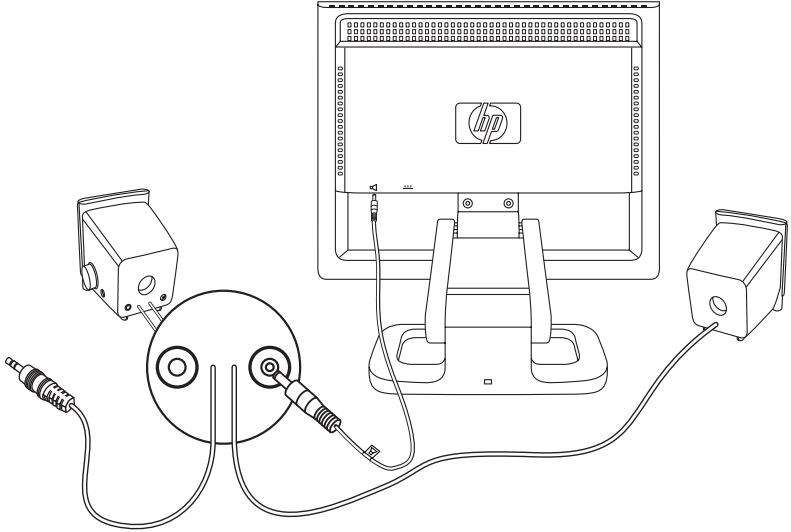

- 3 Plug the power adapter cable into the back of the subwoofer and then plug the power adapter into the main power source.



- 4 Connect the two speakers to the subwoofer:
- Plug the right speaker audio cable (green plug) into the green subwoofer connector.
  - Plug the control cable (purple plug) from the subwoofer into the purple connector on the right speaker.
  - Plug the subwoofer audio cable (green plug) into the PC. Refer to your PC user's guide for instructions on how to connect your speakers to the PC.

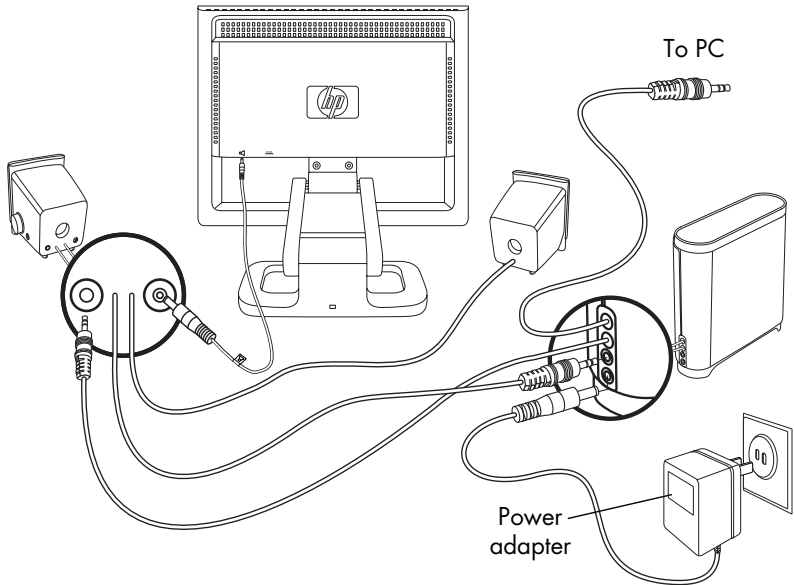

- 5 Turn on the PC, the monitor, the subwoofer, and the speakers.

## Adjusting the Position of the Monitor Screen

The f1503 or f1703 monitor screen is attached to an adjustable pedestal, allowing you to position the monitor screen for best viewing in your particular environment.

*To adjust the monitor position:*

- 1 Grasp the sides of the monitor screen and gently but firmly tilt the top of screen forward or backward to the desired angle.
- 2 While still holding the screen sides, move the screen up or down to the appropriate height within the range of the pedestal arm.

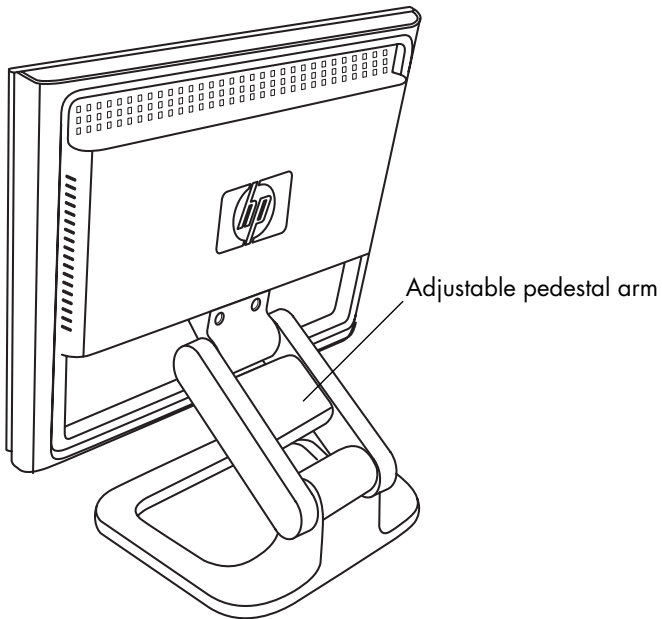

## Securing the monitor

The f1503 or f1703 monitor can be secured to a desk or to any other fixed object, using a Kensington lock security cable. The cable can be attached to a slot located on the rear of the monitor base.

---

**NOTE:** *The Kensington lock is not an HP accessory. It cannot be ordered from HP. Contact your retailer for more information.*

---

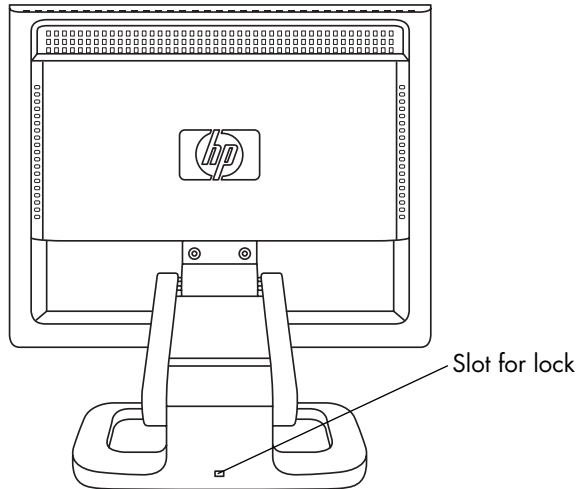

*To secure the monitor:*

- 1 Insert the lock in the slot located on the rear of the monitor base.
- 2 Turn the key to lock the cable to the monitor.
- 3 Remove the key and store it in a safe place.

## Installing the Drivers

The HP monitor comes with driver software allowing you to take advantage of the Plug and Play feature of the Windows® Me, Windows 2000, or Windows XP operating system. This software enables the computer to communicate with the monitor and use all the monitor features. Without this software, the monitor settings and display images cannot be correct.

---

**NOTE:** *HP computers may come with the Plug and Play drivers pre-installed. If you have an older computer, these drivers may not be pre-installed and you may need to install the drivers from the CD-ROM disc that came with the monitor.*

---

You can also download the latest version of a driver from the HP Monitors Support Web site. Go to <http://www.hp.com>, select your country/region, and then follow the links to the support page for monitors.

### Windows 2000 users

---

**NOTE:** *The procedure for installing the driver for your operating system may vary.*

---

To install the driver for the f1503 or f1703 monitor:

- 1 Click **Start**, select **Settings**, and then click **Control Panel**.
- 2 Double-click **Display**.
- 3 Click the **Settings** tab.
- 4 Click **Advanced Properties** or **Advanced**, and select the **Monitor** tab.
- 5 Click **Properties**.
- 6 Click the **Driver** tab.
- 7 Click **Update Driver** and click **Next**.
- 8 Select the recommended option and then click **Next**.
- 9 Select the **Specify a Location** box.
- 10 Find and open the **f1503.inf** (f1503 15-inch) or the **f1703.inf** (f1703 17-inch) file on the CD-ROM disc in the Drivers directory, and click **OK**.
- 11 Click **Next** to install the selected monitor.

## Windows Me users

---

**NOTE:** *The procedure for installing the driver for your operating system may vary.*

---

To install the driver for the f1503 or f1703 monitor:

- 1 Click **Start**, select **Settings**, and then click **Control Panel**.
- 2 Click **Display**.
- 3 Select the **Settings** tab.
- 4 Click the **Advanced** button.
- 5 Select the **Monitor** tab.
- 6 Click the **Change** button.
- 7 Select the **Specify a Location** box.
- 8 Find and open the **f1503.inf** (f1503 15-inch) or the **f1703.inf** (f1703 17-inch) file on the CD-ROM disc in the Drivers directory, and click **OK**.
- 9 Click **Next** to install the selected monitor.

## Windows XP users

---

**NOTE:** *The procedure for installing the driver for your operating system may vary.*

---

To install the driver for the f1503 or f1703 monitor:

- 1 Click **Start**.
- 2 Click **Control Panel**.
- 3 Click **Appearance and Themes**.
- 4 Click **Display**.
- 5 Select the **Settings** tab.
- 6 Click the **Advanced** button.
- 7 Select the **Monitor** tab.
- 8 Click **Properties**.
- 9 Select the **Driver** tab.
- 10 Click **Update Driver** and click **Next**.
- 11 Select the recommended option and then click **Next**.

- 12 Select the **Specify a Location** box.
- 13 Find and open the **f1503.inf** (f1503 15-inch) or the **f1703.inf** (f1703 17-inch) file on the CD-ROM disc in the Drivers directory, and click **OK**.
- 14 Click **Next** to install the selected monitor.

If the installation procedure of the monitor driver for the Windows 2000, Windows Me, or Windows XP operating system is different, or if you need more detailed installation information, please refer to the Microsoft Windows information that came with the computer.

## Using the Monitor

There are five control buttons on the f1503 or f1703 monitor. They perform the following operations:

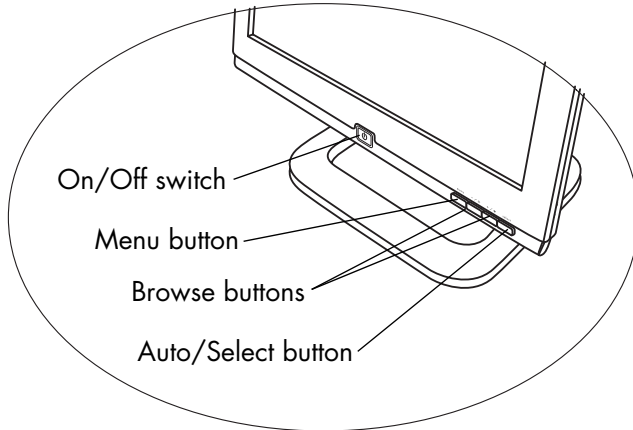

| Control button/icon   | Function when not in On Screen Display                                    | Function in On Screen Display                                  |
|---|---|--|
| menu  | <b>Menu:</b> Opens and closes the On Screen Display window                | Closes setting screens and exits On Screen Display             |
| — / ☀   | <b>Left Browse/Brightness:</b> Shortcut to Brightness setting screen      | Navigates setting menus and adjusts settings                   |
| + / ●   | <b>Right Browse/Contrast:</b> Shortcut to Contrast setting screen         | Navigates setting menus and adjusts settings                   |
| select  | <b>Auto/Select:</b> Performs an auto-adjustment to optimize image quality | Acts as an Enter (Select) key to select setting screen options |
|  | <b>On/Off:</b> Turns the monitor on or off                                | Turns the monitor on or off                                    |

## Using the Auto-Adjustment function

You can easily optimize the screen performance for the VGA interface by using the Select button and the auto-adjustment pattern software (Adjustment pattern.exe) on the CD-ROM disc provided.

- 1 Insert the provided CD-ROM disc into the computer.
- 2 Run the software file D:\Adjustment pattern.exe to display a setup test pattern.
- 3 Press the Select button to produce a stable, centered image.

The optimizer utility on the CD-ROM contains the drivers for Windows Me, Windows 2000, or Windows XP. For the f1503 monitor, use the D:\Drivers\f1503.inf file. For the f1703 monitor, use the D:\Drivers\f1703.inf file.



## Adjusting the Monitor Settings

The monitor display has several adjustable settings that may need occasional fine-tuning. Adjust the monitor after:

- Installing the monitor for the first time.
- Changing the resolution (number of pixels on the display) or refresh rate (vertical scan frequency rate).
- Changing the graphic card.
- Connecting the monitor to a different computer.
- Using the Factory Settings function. See “Using the Factory settings option” on page 35.

---

**NOTE:** *For best performance, it is recommended that you select a video mode of 1024 x 768 @ 60 Hz for the f1503 monitor and 1280 x 1024 @ 60 Hz for the f1703 monitor on the computer.*

---

### Using the On Screen Display

The monitor comes pre-configured to provide the best viewing image. However, you can fine-tune the display by using On Screen Display (OSD). The monitor control buttons allow you to open the On Screen Display to select and adjust display settings.

To adjust display settings:

- 1 Press the Menu button to open On Screen Display to the OSD Main Menu.



On Screen Display screen

- 2 Press a Browse button to navigate the setting menus; see the following setting menu table.
- 3 When the menu you want is selected, press the Select button to open the setting screen for that option.

---









**NOTE:** *Some main menu selections open submenus. When a sub-menu opens, choose the appropriate option menu and then press the Select button to open the setting screen for that option.*

---

- 4 Adjust the setting by using the instructions described in the topics that follow for each type of setting.
- 5 To exit On Screen Display, press the Menu button or choose **Exit** and press the Select button.

### Setting menus

The menus on the OSD Main Menu in the On Screen Display screen offer different setting options, shown in the following table:

| Icon  | Setting menu            | Setting description  |
|---|-------------------------|--|
|    | Brightness/<br>Contrast | Adjusts the brightness or the difference between the light and dark area.  |
|    | Image Control           | Adjusts the: <ul style="list-style-type: none"><li>• Horizontal position of the screen image.</li><li>• Vertical position of the screen image.</li><li>• Frequency of the pixel clock to minimize vertical bar.</li><li>• Phase value to minimize horizontal jitters.</li></ul>  |
|    | Advanced                | Displays a sub-menu with two options: <ul style="list-style-type: none"><li>• Color: Adjusts the color tint of white, and the red, green, and blue (RGB) mix for colors.</li><li>• OSD (On Screen Display) settings: Adjusts the position, timeout, and notification features of the On Screen Display window.</li></ul> |
|    | Auto<br>Configuration   | Adjusts the main settings and produces a stable, centered image.   |
|    | Factory settings        | Resets the display to original factory settings for color, brightness, phase, and clock.   |
|  | Language                | Shows the language of the OSD window.  |
|  | Information             | Shows the current resolution and refresh rate; shows the serial number of the display; shows the power-on hours, and the backlight hours.  |
|  | Exit                    | Closes the OSD window.   |

## Adjusting the Horizontal Position, Vertical Position, Clock, Phase, Contrast, or Brightness settings

To change Horizontal Position, Vertical Position, Clock, Phase, Contrast, or Brightness settings:

- 1 Open the appropriate setting screen (Brightness/Contrast or Image Control). See "Using the On Screen Display" on page 25.



- 2 Press the Browse buttons to select the setting you want to adjust.
- 3 Press Select to choose the setting.

- 4 Press the Browse buttons to adjust the setting. The setting is automatically saved as you adjust it.

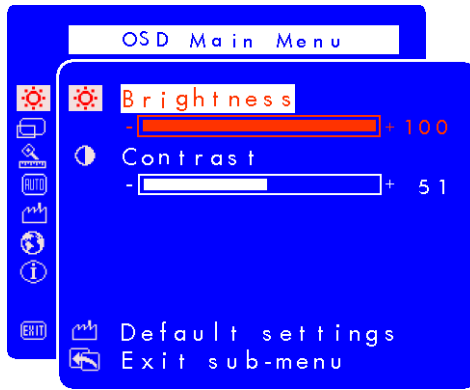

- Horizontal Position — press the left Browse button to move the horizontal position to the left, and press the right Browse button to move the horizontal position to the right.
- Vertical Position — press the left Browse button to move the vertical position down, and press the right Browse button to move the vertical position up.
- Clock — press the left Browse button to decrease the clock setting value, and press the right Browse button to increase the clock setting value.
- Phase — press the left Browse button to decrease phase setting values, and press the right Browse button to increase phase setting values.
- Contrast — press the left Browse button to decrease the contrast, and press the right Browse button to increase the contrast.
- Brightness — press the left Browse button to decrease the brightness, and press the right Browse button to increase the brightness.

---

**NOTE:** You can revert to the factory settings for any of these options by choosing *Default settings*.

---

- 5 Choose **Exit sub-menu** and press the Select button to return to the OSD Main Menu, or press the Menu button to exit OSD.

## Adjusting the Color settings

The Color setting screen is under the Advanced menu. See “Using the On Screen Display” on page 25. Three options appear on the Color setting screen: 9300 K, 6500 K, and User Color. 9300 K and 6500 K refer to tints of white. The 9300 K setting is often used for office environments or fluorescent lighting. The 6500 K setting is often used in environments with incandescent lighting. The User Color setting lets you individually adjust the red, green, and blue (RGB) mix for color generation.



*To adjust tints of white:*

- 1 Open the Color settings screen.
- 2 Press the Browse buttons to select a tint of white. Choose either **9300 K** or **6500 K**.
- 3 Choose **Exit sub-menu** and press the Select button to save the tint setting and return to the OSD Main Menu, or press the Menu button to exit OSD.

To adjust User Color:

- 1 Open the Color settings screen.
- 2 Press the Browse buttons until User Color is selected.
- 3 Press the Select button to check this option.

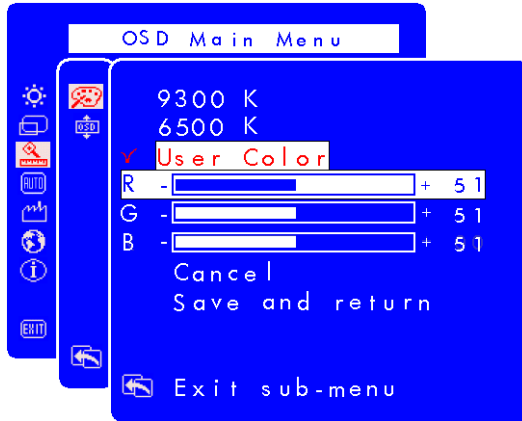

- 4 Press the Browse buttons to select the color you want to adjust.
- 5 Press the Select button to activate the adjustable setting for the color you selected.
- 6 Press the Browse buttons to change the color value.
- 7 After the color is adjusted, press the Select button to deactivate the adjustable setting.
- 8 Repeat steps 4 through 7 for each color you want to adjust.
- 9 Choose **Save** and return to save the changes you have made and return to the previous menu screen or choose **Cancel** to undo any changes. Press the Select button.
- 10 Choose **Exit sub-menu** and press the Select button to save the tint setting and return to the OSD Main Menu, or press the Menu button to exit OSD.

---

**NOTE:** To keep the color values as they were before any adjustments were made, choose **Cancel** and then press the Menu button.

---

## Adjusting the OSD settings

There are four adjustable options on the OSD settings screen: Lock OSD settings, Timeout, H Position, and V Position.

To change OSD settings:

- 1 Open the OSD setting screen under the Advanced menu. See “Using the On Screen Display” on page 25.



- 2 Press the Browse buttons to select the option you want to adjust.
- 3 Press the Select button to check the option.

To change OSD lock setting:

- 1 Press the Browse button to select **yes** (lock) or **no** (unlock). The setting is automatically saved when you change the value.
- 2 Choose **Exit sub-menu** and press the Select button to return to the OSD Main Menu or press the Menu button to exit OSD.

---

**NOTE:** Once OSD is locked, all OSD functions including the shortcut buttons are disabled. If OSD is locked, pressing any button on the monitor directly opens the Lock OSD settings window so that you can unlock OSD.

---



*To adjust OSD Timeout:*

You can set the OSD (On Screen Display) screen to turn off automatically when you are not using it.

- 1 Press the Browse buttons to select how long the On Screen Display screen appears before automatically turning off. The setting is automatically saved as you adjust it.
- 2 Choose **Exit sub-menu** and press the Select button to return to the OSD Main Menu, or press the Menu button to exit OSD.

*To adjust OSD H Position:*

You can adjust the horizontal position of the OSD (On Screen Display) screen.

- 1 Press the Browse buttons to position the OSD screen. The setting is automatically saved as you adjust it.
- 2 When the screen is in the horizontal position you want you can either choose **Exit sub-menu** and press the Select button to return to the OSD Main Menu and make adjustments to other settings, or press the Menu button to exit OSD.

*To adjust OSD V Position:*

You can adjust the vertical position of the OSD (On Screen Display) screen.

- 1 Press the Browse buttons to position the OSD screen. The setting is automatically saved as you adjust it.
- 2 When the screen is in the vertical position you want you can either choose **Exit sub-menu** and press the Select button to return to the OSD Main Menu and make adjustments to other settings, or press the Menu button to exit OSD.

## Using the Auto Configuration option

With Auto Configuration you can reset Horizontal Position, Vertical Position, Clock, and Phase to optimize the image quality. Before using this option be sure you are viewing a full Windows screen, or using the test pattern provided on the CD. The test pattern software file is named Adjustment pattern.exe.

*To change settings with Auto Configuration:*

- 1 Open the Auto Configuration setting screen. See "Using the On Screen Display" on page 25. A window with a progress bar appears and displays until the process is done.

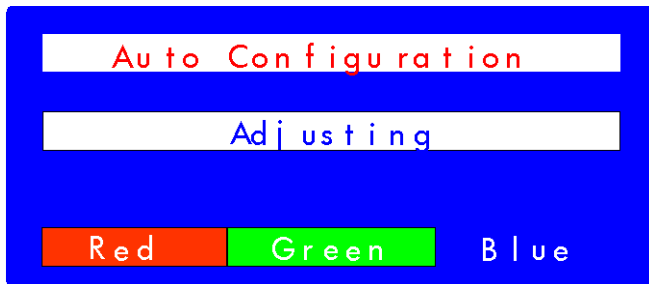

- 2 Press the Select button to proceed with the reset, or press the Menu button to exit without resetting.
- 3 If you reset the settings you can either choose **Exit sub-menu** and press the Select button to return to the OSD Main Menu and make adjustments to other settings, or press the Menu button to exit OSD.

## Using the Factory settings option

Using Factory settings restores original factory settings for Color, Brightness, Phase, and Clock. This re-establishes pre-set color settings for the best possible brightness.

To use Factory settings:

- 1 Open the Factory settings screen. See “Using the On Screen Display” on page 25.



- 2 Press the Browse buttons to select whether or not you want to restore the factory settings.
- 3 Press the Select button to proceed.
- 4 If you reset with Factory settings you can either choose **Exit sub-menu** and press the Select button to return to the OSD Main Menu and make adjustments to other settings, or press the Menu button to exit OSD.

## Selecting a Language for On Screen Display

You can choose to view On Screen Display in English, Spanish, French, German, Italian, Simplified Chinese, or Japanese.

*To change the language of On Screen Display:*

- 1 Open the Languages setting screen. See “Using the On Screen Display” on page 25.



- 2 Press the Browse buttons to choose a language. The setting is automatically saved.
- 3 After selecting a language you can either choose **Exit sub-menu** and press the Select button to return to the OSD Main Menu and make adjustments to other settings, or press the Menu button to exit OSD.

## Viewing serial number, resolution mode, working time information

You may need to provide the display serial number or other information, such as the monitor resolution mode or backlight working time, to HP Support technicians to help them serve you better during a Support call.

The backlight hours refers to the elapsed time of usage for the light behind the display screen. The expected lifespan of the backlight is approximately 25,000 to 30,000 hours. At some point after the maximum usage time of the backlight has been exceeded, you may notice a decrease in brightness of up to 50%. At this point, the backlight needs to be replaced to restore full brightness.



---

**CAUTION:** The backlight can be replaced only by a trained technician. Please contact the HP Support Center for assistance. Do not attempt to replace the light yourself.

---

**NOTE:** Do not use a screen saver with the LCD monitor, as the backlight is used. It is recommended that you enable an automatic power saving mode, or switch off the monitor when not in use.

---

To view the serial number, resolution mode, or working time:

- 1 Open the Information setting screen. See “Using the On Screen Display” on page 25. The current and recommended resolution mode, the serial number, the total monitor working time, and backlight working time displays.

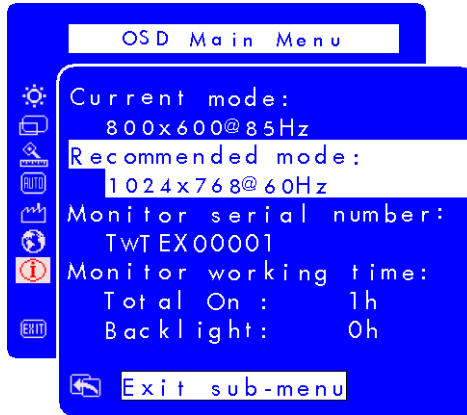

- 2 After viewing the information you can either choose **Exit sub-menu** and press the Select button to return to the OSD Main Menu and make adjustments to other settings, or press the Menu button to exit OSD.

## Troubleshooting

If you are having trouble with the monitor, these tips may help you solve the problem. Try the following steps before calling HP.

---

**NOTE:** *The On Screen Display manager also features pop-up warning messages for certain situations, such as if you attempt to set the monitor resolution outside the recommended range.*

---

If you find:

*No picture and the light indicator on the front of the LCD panel is off:*

- Check that the monitor is turned on.
- Check that the power cord is properly connected.
- Check the electrical outlet.
- Connect the monitor to another computer to determine if there is a problem with the computer rather than with the monitor.

*No picture and the light indicator on the front of the LCD panel is on:*

- Check that the computer is turned on.
- Check that the monitor is not in power-saving mode.
- Adjust the Contrast and Brightness through the On Screen Display or the control buttons.
- Check that the video cable has no bent pins.
- Connect the monitor to another computer to determine if there is a problem with the computer rather than the monitor.

*Picture is fuzzy:*

- Adjust the monitor using the Auto-Adjustment function. See "Using the Auto-Adjustment function" on page 24.
- If you are running the Windows Me, Windows 2000, or Windows XP operating system, install the Plug and Play driver (.inf file). See "Installing the Drivers" on page 20.
- For the f1503 monitor, change the resolution to the recommended resolution of 1024 x 768 @ 60 Hz.
- For the f1703 monitor, change the resolution to the recommended resolution of 1280 x 1024 @ 60 Hz.

*Pixels are missing:*

- See “LCD Monitor Quality and Pixel Policy for f1503 Monitor” on page 41.
- See “LCD Monitor Quality and Pixel Policy for f1703 Monitor” on page 42.

*Colors are not pure:*

- Check that the video cable has no bent pins and is firmly attached to both the computer and monitor video connectors.
- Restore the original factory colors setting. See “Using the Factory settings option” on page 35.
- Adjust the RGB (red, green, and blue) colors. See “Adjusting the Color settings” on page 30.

*Picture is not centered:*

- Adjust the monitor using the Auto-Adjustment function. See “Using the Auto-Adjustment function” on page 24.



## *LCD Monitor Quality and Pixel Policy for f1503 Monitor*

### **f1503 15-inch monitor**

The HP f1503 TFT monitor uses high-precision technology, manufactured according to HP standards, to guarantee trouble-free performance. Nevertheless, the display may have cosmetic imperfections that appear as small bright or dark spots. This is common to all LCD displays used in products supplied by all vendors and is not specific to the HP f1503 LCD. These imperfections are caused by one or more defective pixels or sub-pixels.

- A pixel consists of one red, one green, and one blue sub-pixel.
- A defective whole pixel is always turned on (a bright spot on a dark background), or it is always off (a dark spot on a bright background). The first is the more visible of the two.
- A defective sub-pixel (dot defect) is less visible than a defective whole pixel and is small and only visible on a specific background.

The HP f1503 display does not have more than:

- 10 total dot defects.
- 10 defective full pixels.
- 10 defective red sub-pixels.
- 4 defective green sub-pixels (green is most visible).
- 10 defective blue sub-pixels.
- No more than two adjacent (less than 2.5 mm edge-to-edge) defective pixels.
- No more than two pairs of two adjacent defective pixels.

To locate defective pixels, the monitor should be viewed under normal operating conditions, in normal operating mode at a supported resolution and refresh rate, from a distance of approximately 50 cm (16 in.).

HP expects that, over time, the industry will continue to improve its ability to produce LCDs with fewer cosmetic imperfections and HP will adjust guidelines as improvements are made.

## *LCD Monitor Quality and Pixel Policy for f1703 Monitor*

### **f1703 17-inch monitor**

The HP f1703 TFT monitor uses high-precision technology, manufactured according to HP standards, to guarantee trouble-free performance. Nevertheless, the display may have cosmetic imperfections that appear as small bright or dark spots. This is common to all LCD displays used in products supplied by all vendors and is not specific to the HP f1703 displays. These imperfections are caused by one or more defective pixels or sub-pixels.

- A pixel consists of one red, one green, and one blue sub-pixel.
- A defective whole pixel is always turned on (a bright spot on a dark background), or it is always off (a dark spot on a bright background). The first is the more visible of the two.
- A defective sub-pixel (dot defect) is less visible than a defective whole pixel and is small and only visible on a specific background.

The HP f1703 display does not have more than:

- 15 total dot defects.
- 10 defective full pixels.
- 10 defective red sub-pixels.
- 4 defective green sub-pixels (green is most visible).
- 10 defective blue sub-pixels.
- No more than two adjacent (less than 2.5 mm edge-to-edge) defective pixels.
- No more than two pairs of two adjacent defective pixels.

To locate defective pixels, the monitor should be viewed under normal operating conditions and in normal operating mode at a supported resolution and refresh rate, from a distance of approximately 50 cm (16 in.).

HP expects that, over time, the industry will continue to improve its ability to produce displays with fewer cosmetic imperfections and HP will adjust guidelines as improvements are made.

## Technical Specifications for the f1503 Monitor

### f1503 15-inch monitor

|                                |   |  |
|--------------------------------|---|--|
| Liquid Crystal Display (LCD)   | Display Size  | 15-in. (38 cm) diagonal and viewable image   |
|                                | Type  | TFT liquid crystal display   |
| Input Signal                   | Video   | 0.7 V (0,7 V) p-p analog RGB   |
|                                | Synchronization   | Separated H/V (TTL level)  |
| Interface                      | Input Connector   | Analog R, G, B separate<br>H, V sync.  |
| Scanning Frequency             | Horizontal  | 30–63 kHz  |
|                                | Vertical  | 56–76 Hz   |
| Max. Resolution (H x V)        | 1024 x 768 @ 75 Hz  |  |
| Recommended Resolution (H x V) | 1024 x 768 @ 60 Hz  |  |
| Power Source                   | AC/DC Adapter   | Input Rating:<br>100–240 V $\sqrt{\phantom{x}}$ , 2 A max<br>Output Rating:<br>12 V $\overline{\text{---}}$ , 3.5A<br>Frequency: 50/60 Hz<br>Power Consumption: Less than 40 W in operating mode |
| Operating Environment          | Temperature   | 10° C to 35° C   |
|                                | Humidity  | 20% RH through 80% RH<br>(without condensation)  |
| Storage Environment            | Temperature   | –10° C to 60° C  |
|                                | Humidity  | 5% RH through 90% RH<br>(without condensation)   |
| Dimensions                     | W x D x H<br>With stand: 363 x 258 x 443 mm<br>(14.29 x 10.16 x 17.44 in) |  |
| Weight                         | With stand: 4.5 Kg (9.9 lbs)  |  |

hp pavilion f1503/f1703 LCD Monitor  
Technical Specifications for the f1503 Monitor

---

|               |   |  |
|---------------|---|--|
| Tilt Stand    | Maximum tilt angle range  | -47.5 degrees – +9.5 degrees<br>Tilt range may vary depending on your height adjustment. |
|               | Maximum height adjustment (inches/millimeters)                                      | 4.72"/120 mm.<br>Height adjustment may vary depending on tilt angle adjustment.          |
| Security Lock | Monitor cabinet is provided with a slot allowing the use of Kensington lock device. |  |

## Technical Specifications for the f1703 Monitor

### f1703 17-inch monitor

|                                |   |   |
|--------------------------------|---|---|
| Liquid Crystal Display (LCD)   | Display Size  | 17-in. (43 cm) diagonal and viewable image  |
|                                | Type  | TFT liquid crystal display  |
| Input Signal                   | Video   | 0.7 Vp-p analog RGB   |
|                                | Synchronization   | Separated H/V (TTL level)   |
| Interface                      | Input Connector   | 15-pin D-SUB (Analog)   |
| Scanning Frequency             | Horizontal  | 30–83 kHz   |
|                                | Vertical  | 56–76 Hz  |
| Max. Resolution (H x V)        | 1280 x 1024 @ 75 Hz   |   |
| Recommended Resolution (H x V) | 1280 x 1024 @ 60 Hz   |   |
| Power Source                   | AC/DC Adapter   | Input Rating:<br>100–240 V <sup>~</sup> , 2 A max<br>Output Rating:<br>12 V ---, 3.75 A<br>Frequency: 50/60 Hz<br>Power Consumption: Less than 50 W in operating mode |
| Operating Environment          | Temperature   | 10° C to 35° C  |
|                                | Humidity  | 20% RH through 80% RH (without condensation)  |
| Storage Environment            | Temperature   | –10° C to 60° C   |
|                                | Humidity  | 5% RH through 90% RH (without condensation)   |
| Dimensions                     | W x D x H<br>With standard stand: 404 x 274 x 482 mm<br>(15.91 x 10.79 x 18.98 in.) |   |
| Weight                         | With standard stand: 7 Kg (15.43 lbs)   |   |

hp pavilion f1503/f1703 LCD Monitor  
Technical Specifications for the f1703 Monitor

---

|               |   |  |
|---------------|---|--|
| Tilt Stand    | Maximum tilt angle range  | -47.5 degrees – +9.5 degrees<br>Tilt range may vary depending on your height adjustment. |
|               | Maximum height adjustment range (inches/millimeters)                                | 4.52"/115mm.<br>Height adjustment may vary depending on tilt angle adjustment.           |
| Security Lock | Monitor cabinet is provided with a slot allowing the use of Kensington lock device. |  |

## Care and Cleaning

To maximize the screen lifespan of this product and to prevent damage to the liquid crystal display, it is recommended that you:

- Do not let liquid get on or into the monitor.
- Do not store or use the monitor in locations exposed to heat, direct sunlight, or extreme cold.
- Do not store or use the monitor in a dusty environment or in locations exposed to high humidity.
- Do not press sharp or pointed objects against the monitor.
- Avoid touching or pressing the screen of the monitor.
- Avoid setting contrast and brightness to their maximum levels for prolonged periods.
- Turn off the monitor when not in use.
- Clean the screen with isopropyl alcohol or ethyl alcohol diluted with water (1:1) to prevent damage to the screen's anti-glare coating.

To clean the screen:

- 1 Turn off the monitor and remove the power plug (pull the plug, not the cable).
- 2 Soak a soft gauze cloth with isopropyl alcohol or ethyl alcohol diluted with water (1:1) and gently wipe the surface of the monitor. Do not dust it or wipe it with a cloth dampened with pure water.
- 3 Dry with a clean, soft cotton cloth.



---

**CAUTION:** Never use pure water to clean the LCD screen. Do not use cleaning solutions containing fluoride, acids, or alkalis. Do not use ketone substances such as acetone or solvents such as xylene or toluene to clean the monitor. Do not use benzene, thinner, ammonia, or any volatile substance to clean the monitor's screen or cabinet. These chemicals may damage the monitor.

---

## *Environmental Information*

HP has a strong commitment to the environment. The HP monitor has been designed with respect for the environment as much as possible.

HP can also take back your old monitor for recycling when it reaches the end of its useful life.

HP has a product take-back program in several countries/regions. The collected equipment is sent to one of HP's recycling facilities in Europe or the USA. As many parts as possible are reused. The remainder is recycled. Special care is taken with batteries and other potentially toxic substances; these are reduced to harmless components through a special chemical process. If you require more details about HP's product take-back program, contact your dealer or your nearest HP sales office.



## *Regulatory Information*

### **Notice for the USA: FCC Class B Statement**

*Federal Communications Commission*

*Radio Frequency Interference Statement Warning:*

This equipment has been tested and found to comply with the limits for a Class B digital device, pursuant to Part 15 of the FCC Rules. These limits are designed to provide reasonable protection against harmful interference in a residential installation. This equipment generates, uses, and can radiate radio frequency energy and, if not installed and used in accordance with the instructions, may cause harmful interference to radio communications. However, there is no guarantee that interference will not occur in a particular installation. If this equipment does cause harmful interference to radio or television reception, that can be determined by turning the equipment off and on, the user is encouraged to correct the interference by one or more of the following measures:

- Reorient or relocate the receiving antenna.
- Increase the separation between the equipment and the receiver.
- Connect the equipment into an outlet on a circuit different from that to which the receiver is connected.
- Consult the dealer or an experienced radio or television technician for help.

### **Modifications**

The FCC requires the user to be notified that any changes or modifications made to this device that are not expressly approved by HP may void the user's authority to operate the equipment.

### **Cables**

Connections to this device must be made with shielded cables with metallic RFI/EMI connector hoods to maintain compliance with FCC Rules and Regulations.

## **Notice for the USA: Declaration of Conformity for Products Marked with FCC Logo**

This device complies with Part 15 of the FCC Rules. Operation is subject to the following two conditions: (1) this device may not cause harmful interference, and (2) this device must accept any interference received, including interference that may cause undesired operation.

For questions regarding your product, contact:

USA contact: Hewlett-Packard Company  
P.O. Box 692000, Mail Stop 530113  
Houston, TX 77269-2000

or call (+1) (208) 472-4357 (208-4PC-HELP)

For questions regarding this FCC declaration, contact:

USA contact: Hewlett-Packard Company  
Corporate Product Regulations Manager  
P.O. Box 692000, Mail Stop 530113  
Houston, TX 77269-2000

or call (+1) (281) 514-3333

To identify this product, refer to the Part, Series, or Model number found on the product.

## **Notice for Canada**

This Class "B" digital apparatus meets all requirements of the Canadian Interference-Causing Equipment Regulations.

## **Avis Canadien**

Cet appareil numérique de la Classe B est respecte toutes les exigences du Règlement sur le matériel brouilleur du Canada.

## **European Union Notice**

Products bearing the CE Marking comply with the EMC Directive (89/336/EEC) and the Low Voltage Directive (73/23/EEC) issued by the Commission of the European Community and if this product has telecommunication functionality, the RTTE Directive (1999/5/EC).

Compliance with these directive implies conformity to the following European norms (in parentheses are the equivalent international standards and regulations):

- EN 55022 (CISPR 22) — Electromagnetic Interference
- EN 55024 (IEC6100-4-2, 3, 4, 5, 6, 8, 11) — Electromagnetic Immunity
- EN 61000-3-2 (IEC6100-3-2) — Power Line Harmonics
- EN 61000-3-3 (IEC61000-3-3) — Power Line Flicker
- EN 60950 (IEC 60950) — Product Safety

## MPRII Statement

The monitor complies with MPRII guidelines for upper limits of electrostatic and magnetic field emissions, from the Swedish National Board of Measurement and Testing.

## Notice for Korea

사용자 안내문 (B급기기)  
이 기기는 비업무용으로 전자파장해 검정을 받은  
기기로서, 주거지역에서는 물론 모든 지역에서  
사용할 수 있습니다.

## Notice for Germany

### Hinweis für Deutschland: Geräuschemission

Lärmangabe nach Maschinenlärmmverordnung — 3 GSGV  
(Deutschland)

LpA < 70db am Arbeitsplatz normaler Betrieb nach  
EN27779: 11.92

## Notice for Japan (Class B)

この装置は、情報処理装置等電波障害自主規制協議会（VCCI）の基準に基づくクラスB情報技術装置です。この装置は、家庭環境で使用することを目的としていますが、この装置がラジオやテレビジョン受信機に近接して使用されると、受信障害を引き起こすことがあります。  
取り扱い説明書に従って正しい取り扱いをして下さい。

## Power Cords

The power cord set (flexible cord or wall plug) received with the monitor meets the requirements for use in the country/region where you purchased the equipment.

If you need to obtain a power cord for a different country/region, you should purchase a power cord that is approved for use in that country/region.

The power cord must be rated for the product and for the voltage and current marked on the product electrical ratings label. The voltage and current rating of the cord should be greater than the voltage and current rating marked on the product. In addition, the diameter of the wire must be a minimum of 0.75 mm<sup>2</sup> or 18AWG, and the length of the cord must be between 6 feet (1.8m) and 12 feet (3.6m). If you have questions about the type of power cord to use, contact your HP authorized service provider.

A power cord should be routed so that it is not likely to be walked on or pinched by items placed upon it or against it. Particular attention should be paid to the plug, electrical outlet, and the point where the cord exits from the product.

## Energy Star Compliance



Hewlett-Packard Pavilion PCs and Monitors marked with the ENERGY STAR® logo on the packaging box qualify with the U.S. Environmental Protection Agency's ENERGY STAR® guidelines for energy efficiency.

Products with the ENERGY STAR® label are designed to use less energy, help you save money on utility bills, and help protect the environment.

ENERGY STAR® is a registered trademark owned by the U.S. government.



## TCO '99

You have just purchased a TCO '99 approved and labeled product! Your choice has provided you with a product developed for professional use. Your purchase has also contributed to reducing the burden on the environment and to the further development of environmentally adapted electronics products.

### *Why do we have environmentally labeled computers?*

In many countries/regions, environmental labeling has become an established method for encouraging the adaptation of goods and services to the environment. The main problem, as far as computers and other electronics equipment are concerned, is that environmentally harmful substances are used both in the products and during their manufacture. Since it is not so far possible to satisfactorily recycle the majority of electronics equipment, most of these potentially damaging substances sooner or later enter nature.

There are also other characteristics of a computer, such as energy consumption levels, that are important from the viewpoints of both the work (internal) and natural (external) environments. Since all methods of electricity generation have a negative effect on the environment (for example, acidic and climate-influencing emissions, radioactive waste), it is vital to save energy. Electronics equipment in offices is often left running continuously and thereby consumes a lot of energy.

### *What does the environmental labeling involve?*

This product meets the requirements for the TCO '99 scheme which provides for an international and environmental labeling of personal computers. The labeling scheme was developed as a joint effort by the TCO (The Swedish Confederation of Professional Employees), Svenska Naturskyddsforeningen (The Swedish Society for Nature Conservation), Statens Energimyndighet (The Swedish National Energy Administration), and SEMKO AB.

The requirements cover a wide range of issues: Environmental, ergonomic, usability, reduction of electric and magnetic fields, energy consumption, and electrical safety.

The environmental demands impose restrictions on the presence and use of heavy metals, brominated and chlorinated flame retardants, CFCs (freons) and chlorinated solvents, among other things. The product must be prepared for recycling, and the manufacturer is obliged to have an environmental policy which must be adhered to in each country/region where the company implements its operational policy.

The energy requirements include a demand that the computer and/or monitor, after a certain period of inactivity, shall reduce its power consumption to a lower level in one or more stages. The length of time to reactivate the computer shall be reasonable for the user.

Below, you will find a brief summary of the environmental requirements met by this product. The complete environmental criteria document may be ordered from:

TCO Development  
SE-114 94 Stockholm, Sweden

Fax: +46 8 782 92 07

E-mail (Internet): [development@tco.se](mailto:development@tco.se)

Current information regarding TCO '99 approved and labeled products may also be obtained over the Internet, using the address:  
<http://www.tco-info.com/>

## Environmental requirements

### *Flame retardants:*

Flame retardants are present in printed circuit boards, cables, wires, casings and housings. Their purpose is to prevent, or at least to delay, the spread of fire. Up to 30% of the plastic in a computer casing can consist of flame retardant substances. Most flame retardants contain bromine or chloride, and those flame retardants are chemically related to another group of environmental toxins, PCBs. Both the flame retardants containing bromine or chloride and the PCBs are suspected of giving rise to severe health effects, including reproductive damage in fish-eating birds and mammals, due to the bio-accumulative\* processes. Flame retardants have been found in human blood and researchers fear that disturbances in fetus development may occur.

The relevant TCO '99 demand requires that plastic components weighing more than 25 grams must not contain flame retardants with organically bound bromine or chlorine. Flame retardants are allowed in the printed circuit boards since no substitutes are available.

### *Cadmium†:*

Cadmium is present in rechargeable batteries and in the colour-generating layers of certain computer displays. Cadmium damages the nervous system and is toxic in high doses. The relevant TCO '99 requirement states that batteries, the colour-generating layers of display screens and the electrical or electronics components must not contain any cadmium.

\* Bio-accumulative is defined as substances which accumulate within living organisms.

† Lead, Cadmium and Mercury are heavy metals which are Bio-accumulative.

*Mercury\**:

Mercury is sometimes found in batteries, relays and switches. It damages the nervous system and is toxic in high doses. The relevant TCO '99 requirement states that batteries may not contain any mercury. It also demands that mercury is not present in any of the electrical or electronics components associated with the labeled unit. There is however one exception. Mercury is, for the time being, permitted in the back light system of flat panel monitors as there today is no commercially available alternative. TCO aims on removing this exception when a mercury free alternative is available.

*CFCs (freons):*

The relevant TCO '99 requirement states that neither CFCs nor HCFCs may be used during the manufacture and assembly of the product. CFCs (freons) are sometimes used for washing printed circuit boards. CFCs break down ozone and thereby damage the ozone layer in the stratosphere, causing increased reception on earth of ultraviolet light with e.g. increased risks of skin cancer (malignant melanoma) as a consequence.

*Lead\**:

Lead can be found in picture tubes, display screens, solders and capacitors. Lead damages the nervous system and in higher doses, causes lead poisoning. The relevant TCO '99 requirement permits the inclusion of lead since no replacement has yet been developed.

---

\* Lead, Cadmium and Mercury are heavy metals which are Bio-accumulative.