

# *DVD Recorder*

---

Hookups and Settings



*RDR-GX7*

# WARNING

To prevent fire or shock hazard, do not expose the unit to rain or moisture. To avoid electrical shock, do not open the cabinet. Refer servicing to qualified personnel only. Mains lead must only be changed at a qualified service shop.

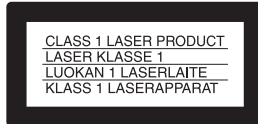

This appliance is classified as a CLASS 1 LASER product. The CLASS 1 LASER PRODUCT MARKING is located on the rear exterior.

## CAUTION

The use of optical instruments with this product will increase eye hazard. As the laser beam used in this DVD recorder is harmful to eyes, do not attempt to disassemble the cabinet. Refer servicing to qualified personnel only.

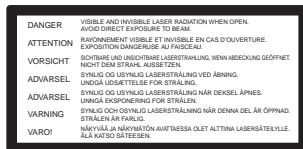

This label is located on the laser protective housing inside the enclosure.

## Notice for customers in the United Kingdom and Republic of Ireland

A moulded plug complying with BS1363 is fitted to this equipment for your safety and convenience. Should the fuse in the plug supplied need to be replaced, a 5 AMP fuse approved by ASTA or BSI to BS1362, (i.e., marked with or mark) must be used.

If the plug supplied with this equipment has a detachable fuse cover, be sure to attach the fuse cover after you change the fuse. Never use the plug without the fuse cover. If you should lose the fuse cover, please contact your nearest Sony service station.

## Precautions

- This unit operates on 220 – 240 V AC, 50/60 Hz. Check that the unit's operating voltage is identical with your local power supply.
- To prevent fire or shock hazard, do not place objects filled with liquids, such as vases, on the apparatus.

VIDEO Plus+ and PlusCode are registered trademarks of Gemstar Development Corporation. The VIDEO Plus+ system is manufactured under license from Gemstar Development Corporation.

# Precautions

This equipment has been tested and found to comply with the limits set out in the EMC Directive using a connection cable shorter than 3 metres.

## On safety

Should any solid object or liquid fall into the cabinet, unplug the recorder and have it checked by qualified personnel before operating it any further.

## On power sources

- The recorder is not disconnected from the AC power source (mains) as long as it is connected to the wall outlet, even if the recorder itself has been turned off.
- If you are not going to use the recorder for a long time, be sure to disconnect the recorder from the wall outlet. To disconnect the AC power cord (mains lead), grasp the plug itself; never pull the cord.

## On placement

- Place the recorder in a location with adequate ventilation to prevent heat build-up in the recorder.
- Do not place the recorder on a soft surface such as a rug that might block the ventilation holes.
- Do not place the recorder in a confined space such as a bookshelf or similar unit.
- Do not place the recorder in a location near heat sources, or in a place subject to direct sunlight, excessive dust, or mechanical shock.
- Do not place the recorder in an inclined position. It is designed to be operated in a horizontal position only.
- Keep the recorder and discs away from equipment with strong magnets, such as microwave ovens, or large loudspeakers.
- Do not place heavy objects on the recorder.

## On operation

- If the recorder is brought directly from a cold to a warm location, or is placed in a very damp room, moisture may condense on the lenses inside the recorder. Should this occur, the

recorder may not operate properly. In this case, remove the disc and leave the recorder turned on for about half an hour until the moisture evaporates.

- When you move the recorder, take out any discs. If you don't, the disc may be damaged.

## On recording

- Contents of the recording cannot be compensated if the recording or playback is not made due to a malfunction of the recorder, disc, etc.
- Make trial recordings before taking the actual recording.

## On adjusting volume

Do not turn up the volume while listening to a section with very low level inputs or no audio signals. If you do, the speakers may be damaged when a peak level section is played.

## On cleaning

Clean the cabinet, panel, and controls with a soft cloth slightly moistened with a mild detergent solution. Do not use any type of abrasive pad, scouring powder or solvent such as alcohol or benzine.

## On cleaning discs

Do not use a commercially available cleaning disc. It may cause a malfunction.

## Copyrights

- Television programmes, films, video tapes, discs and other materials may be copyrighted. Unauthorized recording of such material may be contrary to the provisions of the copyright laws. Also, use of this recorder with cable television transmission may require authorization from the cable television transmitter and/or programme owner.
- This product incorporates copyright protection technology that is protected by method claims of certain U.S. patents, other intellectual property rights owned by Macrovision Corporation, and other rights owners. Use of this copyright protection technology must be authorized by Macrovision Corporation, and is intended for home and other limited viewing uses only unless otherwise authorized by Macrovision Corporation. Reverse engineering or disassembly is prohibited.

## Copy guard function

Since the recorder has a copy guard function, programmes received through an external tuner (not supplied) may contain copy protection signals (copy guard function) and as such may not be recordable, depending on the type of signal.

## Music discs encoded with copyright protection technologies

This product is designed to playback discs that conform to the Compact Disc (CD) standard.

Recently, various music discs encoded with copyright protection technologies are marketed by some record companies. Please be aware that among those discs, there are some that do not conform to the CD standard and may not be playable by this product.

### IMPORTANT NOTICE

Caution: This recorder is capable of holding a still video image or on-screen display image on your television screen indefinitely. If you leave a still video image or on-screen display image displayed on your TV for an extended period of time, you risk permanent damage to your television screen. Plasma Display Panels and Projection televisions are especially susceptible to this.

If you have any questions or problems concerning your recorder, please consult your nearest Sony dealer.

## Notes about the Discs

- To keep the disc clean, handle the disc by its edge. Do not touch the surface. Dust, fingerprints, or scratches on the disc may cause it to malfunction.



- Do not expose the disc to direct sunlight or heat sources such as hot air ducts, or leave it in a car parked in direct sunlight as the temperature may rise considerably inside the car.
- After playing, store the disc in its case.
- Clean the disc with a cleaning cloth. Wipe the disc from the centre out.



- Do not use solvents such as benzene, thinner, commercially available cleaners, or anti-static spray intended for vinyl LPs.
- Do not use the following discs.
  - A disc that has a non-standard shape (e.g., card, heart).
  - A disc with a label or sticker on it.
  - A disc that has cellophane tape or sticker adhesive on it.

## Table of Contents

<b>WARNING</b> .....	<b>2</b>
<b>Precautions</b> .....	<b>2</b>

### Basic Hookups and Settings

<b>Quick Overview</b> .....	<b>4</b>
<b>Step 1: Unpacking</b> .....	<b>5</b>
<b>Step 2: Connecting the Aerial Cable</b> .....	<b>5</b>
<b>Step 3: Connecting the Video Cords</b> .....	<b>5</b>
<b>Step 4: Connecting the Audio Cords</b> .....	<b>7</b>
<b>Step 5: Connecting the Mains Lead</b> .....	<b>10</b>
<b>Step 6: Preparing the Remote</b> .....	<b>10</b>
<b>Step 7: Easy Setup</b> .....	<b>11</b>

### Advanced Hookups and Settings

<b>Setting the Clock</b> .....	<b>14</b>
<b>Presetting Channels</b> .....	<b>16</b>
<b>Changing/Disabling the Channels</b> .....	<b>19</b>
<b>Controlling Your TV or AV Amplifier (Receiver)</b> ....	<b>21</b>
<b>Connecting a VCR or Similar Recording Device to the LINE3 Jack</b> .....	<b>22</b>
<b>Connecting to a Satellite or Digital Tuner</b> .....	<b>23</b>
<b>Connecting a PAY-TV/Canal Plus Decoder</b> .....	<b>24</b>
<b>Index</b> .....	<b>26</b>

When you have finished with hookups and settings, refer to the Operating Instructions for further instructions. "Troubleshooting," "Specifications," and "Guide to Parts and Controls" can also be found in the Operating Instructions.

# Basic Hookups and Settings

- Quick Overview . . . . . page 4
- Step 1: Unpacking . . . . . page 5
- Step 2: Connecting the Aerial Cable . . . page 5
- Step 3: Connecting the Video Cords . . . page 5
- Step 4: Connecting the Audio Cords . . . page 7
- Step 5: Connecting the Mains Lead . . . . . page 10
- Step 6: Preparing the Remote . . . . . page 10
- Step 7: Easy Setup . . . . . page 11

## Quick Overview

A quick overview presented in this guide will give you enough information to start using the recorder.

Step 1: Unpacking



Step 2: Connecting the Aerial Cable



Step 3: Connecting the Video Cords



Step 4: Connecting the Audio Cords



Step 5: Connecting the Mains Lead



Step 6: Preparing the Remote



Step 7: Easy Setup

### Notes

- You cannot connect this recorder to a TV that does not have a SCART (EURO AV) or video input jack.
- Be sure to disconnect the mains lead of each component before connecting.

## Step 1: Unpacking

Check that you have the following items:

- Audio/video cord (pinplug × 3 ↔ pinplug × 3) (1)
- Mains lead (1)
- Aerial cable (1)
- Remote commander (remote) (1)
- R6 (size AA) batteries (2)

## Step 2: Connecting the Aerial Cable

Connect the aerial cable by following the steps below. Do not connect the mains lead until you reach “Step 5: Connecting the Mains Lead” (page 10).

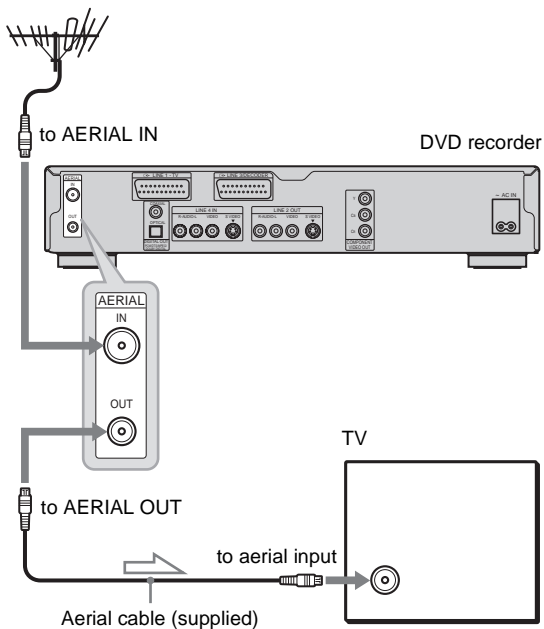

→ : Signal flow

- 1** Disconnect the aerial cable from your TV and connect it to AERIAL IN on the rear panel of the recorder.
- 2** Connect AERIAL OUT of the recorder to the aerial input of your TV, using the supplied aerial cable.

## Step 3: Connecting the Video Cords

Connect this recorder to your TV monitor, projector, or AV amplifier (receiver) using a video cord. Select one of the following patterns **A** through **D**, according to the input jack on your TV monitor, projector, or AV amplifier (receiver). This will enable you to view pictures. Audio connections are explained in “Step 4: Connecting the Audio Cords” (page 7).

### If you are connecting to a VCR or decoder

Connect your VCR to the LINE 3/DECODER jack on the recorder (page 22).

### **A** Connecting to a SCART (EURO AV) input jack

Connect using a SCART (EURO AV) cord (not supplied). Be sure to make the connections firmly to avoid hum and noise. Refer to the operating instructions supplied with the TV to be connected. Also, when you set “Line1 Output” to “S Video” or “RGB” in step 17 of Easy Setup (page 13), use a SCART (EURO AV) cord that conforms to the selected signal.

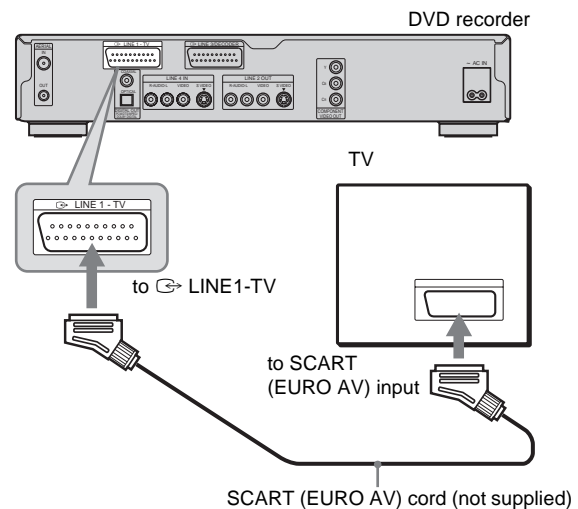

### Notes

- When you connect the recorder to your TV via the SCART (EURO AV) jacks, the TV’s input source is set to the recorder automatically when you start playback. If necessary, press TV/DVD on the remote to return the input to the TV.
- If you connect this recorder to a TV with SMARTLINK, set “Line1 Output” to “Video.”
- For correct SMARTLINK connection, you will need a SCART (EURO AV) cord that has the full 21 pins. Refer to your TV’s instruction manual as well for this connection.

→ continued

## B Connecting to a video input jack

Connect the yellow plug of the audio/video cord (supplied) to the yellow (video) jacks. You will enjoy standard quality images. Use the red and white plugs to connect to the audio input jacks (page 8).

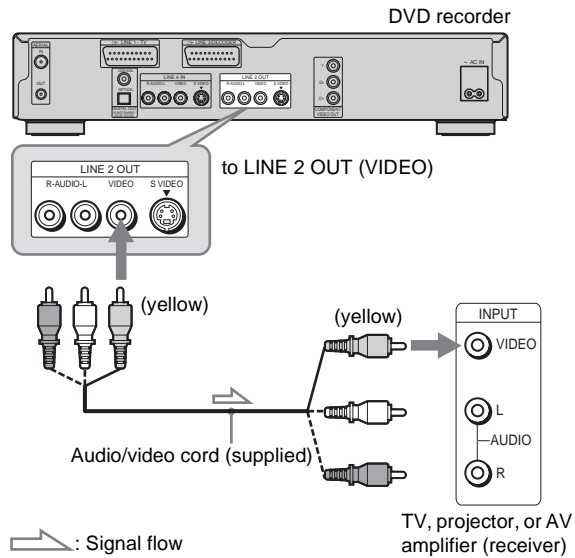

## D Connecting to component video input jacks (Y, CB, CR)

Connect using a component video cord (not supplied) or three video cords (not supplied) of the same kind and length. You will enjoy accurate colour reproduction and high quality images.

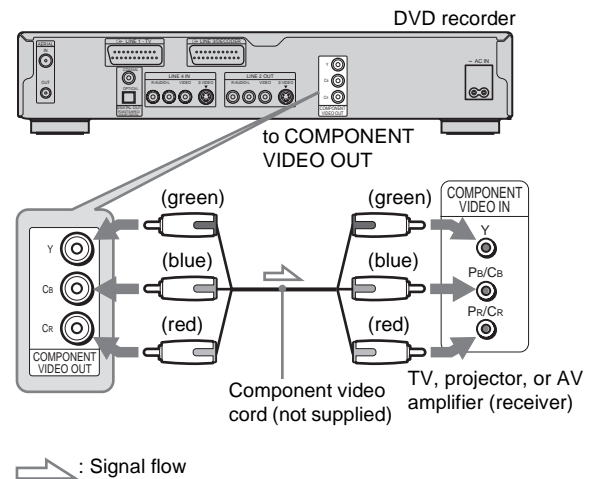

## C Connecting to an S VIDEO input jack

Connect using an S VIDEO cord (not supplied). You will enjoy high quality images.

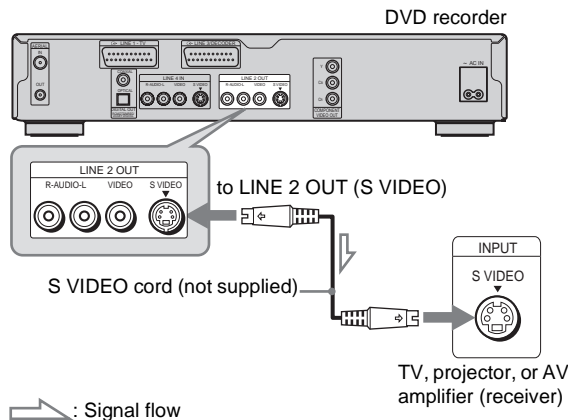

## About the SMARTLINK features (for SCART connections only)

If the connected TV complies with SMARTLINK, NexTVView Link, MEGALOGIC<sup>1</sup>, EASYLINK<sup>2</sup>, CINEMALINK<sup>2</sup>, Q-Link<sup>3</sup>, EURO VIEW LINK<sup>4</sup>, or T-V LINK<sup>5</sup>, this recorder automatically runs the SMARTLINK function after you complete the connection pattern A on page 5 (the SMARTLINK indicator lights up when you turn on your TV). You can enjoy the following SMARTLINK features.

- **Preset Download**  
You can download the tuner preset data from your TV to this recorder, and tune the recorder according to that data in Easy Setup. This greatly simplifies the Easy Setup procedure. Be careful not to disconnect the cables or exit the Easy Setup function during this procedure (page 11).
- **TV Direct Rec**  
You can easily record what you are watching on your TV (see "Recording TV programmes" in the separate booklet "Operating Instructions").
- **One Touch Play**  
You can turn on the recorder and TV, set the TV's input to the recorder, and start playback with one touch of the play button (see "Playing Discs" in the separate booklet "Operating Instructions").
- **One Touch Menu**  
You can turn on the recorder and TV, set the TV to the recorder's channel, and display the Title List menu with one touch of the TITLE LIST button (see "Selecting a Recorded Title on a Disc" in the separate booklet "Operating Instructions").
- **One Touch Timer**  
You can turn on the recorder and TV, set the TV to the recorder's channel, and display the timer programming menu with one touch of the TIMER button on the remote (see "Timer Recording" in the separate booklet "Operating Instructions").
- **Automatic Power Off**  
The recorder will turn off automatically if the recorder is not used after you turn off the TV.
- **NexTVView Download**  
You can easily set the timer by using the NexTVView Download function on your TV. Refer to your TV's instruction manual.

<sup>1</sup>“MEGALOGIC” is a registered trademark of Grundig Corporation.

<sup>2</sup>“EASYLINK” and “CINEMALINK” are trademarks of Philips Corporation.

<sup>3</sup>“Q-Link” is a trademark of Panasonic Corporation.

<sup>4</sup>“EURO VIEW LINK” is a trademark of Toshiba Corporation.

<sup>5</sup>“T-V LINK” is a trademark of JVC Corporation.

**Hint**

SMARTLINK also works with TVs having EPG Timer Control and Now Recording functions. For details, refer to the operating instructions supplied with your TV.

**Notes**

- SMARTLINK features are not available for devices connected via the DVD recorder’s LINE 3/DECODER jack.
- Not all TVs respond to the functions above.

## Step 4: Connecting the Audio Cords

Select the connection that best suits your system. Be sure to read the instructions for the components you wish to connect.

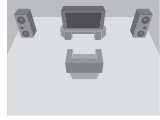
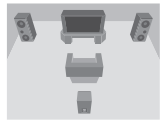
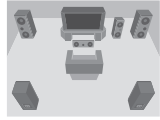
Connection	Your setup
<p><b>A</b></p> <p><b>TV</b></p> <ul style="list-style-type: none"> <li>• Surround effects: Dynamic, Wide</li> </ul>	
<p><b>B</b></p> <p><b>Stereo amplifier (receiver) and two speakers</b></p> <ul style="list-style-type: none"> <li>• Surround effects: Standard</li> </ul> <p><b>MD deck/DAT deck</b></p> <ul style="list-style-type: none"> <li>• Surround effects: None</li> </ul>	
<p><b>C</b></p> <p><b>AV amplifier (receiver) having a Dolby Surround (Pro Logic) decoder<sup>1</sup> and 3 to 6 speakers</b></p> <ul style="list-style-type: none"> <li>• Surround effects: Dolby Surround (Pro Logic)</li> </ul>	
<p><b>D</b></p> <p><b>AV amplifier (receiver) with a digital input jack having a Dolby Digital, MPEG audio, or DTS<sup>2</sup> decoder and 6 speakers</b></p> <ul style="list-style-type: none"> <li>• Surround effects: Dolby Digital (5.1ch), DTS (5.1ch), MPEG audio</li> </ul>	

<sup>1</sup> Manufactured under license from Dolby laboratories. “Dolby,” “Pro Logic,” and the double-D symbol are trademarks of Dolby Laboratories.

<sup>2</sup> “DTS” and “DTS Digital Out” are trademarks of Digital Theater Systems, Inc.

## A Connecting to your TV

This connection will use your TV's speakers for sound. If you use the SCART (EURO AV) cord in pattern **A** of "Step 3: Connecting the Video Cords" (page 5), you do not have to connect audio cords to your TV.

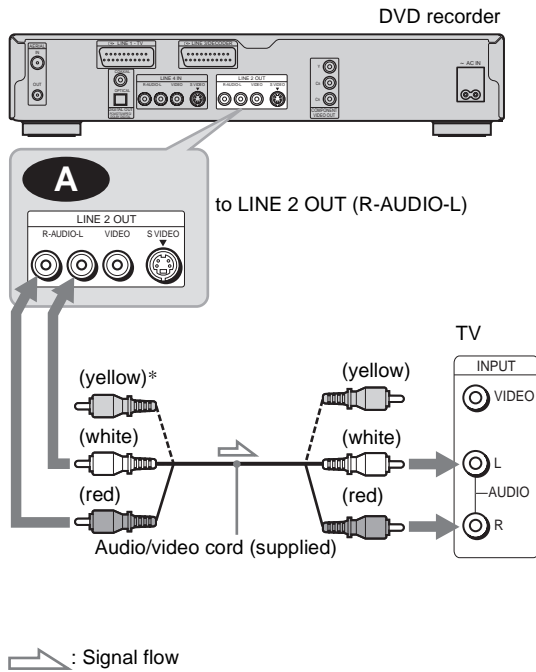

\* The yellow plug is used for video signals (page 6).

### Hint

When connecting to a monaural TV, use a stereo-mono conversion cord (not supplied). Connect the LINE 2 OUT (R-AUDIO-L) jacks to the TV's audio input jack.

### Note

Do not connect the LINE 4 IN (R-AUDIO-L) jacks to your TV's audio output jacks at the same time.

## B Connecting to a stereo amplifier (receiver) and 2 speakers/Connecting to an MD deck or DAT deck

If your stereo amplifier (receiver) only has audio input jacks L and R, use **B-1**. If your amplifier (receiver) has a digital input jack, or when connecting to an MD deck or DAT deck, use **B-2**. In this case, you can also connect the recorder directly to the MD deck or DAT deck without using your stereo amplifier (receiver).

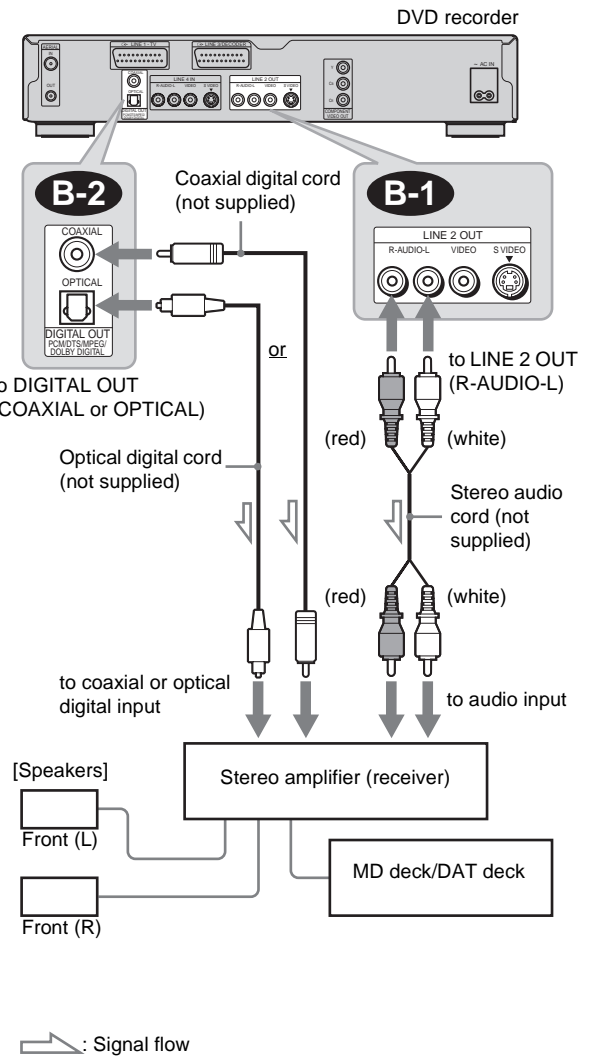

### Hint

For connection **B-1**, you can use the supplied audio/video cord instead of using a separate stereo audio cord.



### C Connecting to an AV amplifier (receiver) having a Dolby Surround (Pro Logic) decoder and 3 to 6 speakers

If your AV amplifier (receiver) only has L and R audio input jacks, use **C-1**. If your amplifier (receiver) has a digital input jack, use **C-2**.

You can enjoy Dolby Surround effects only when playing Dolby Surround audio or multi-channel audio (Dolby Digital) discs.

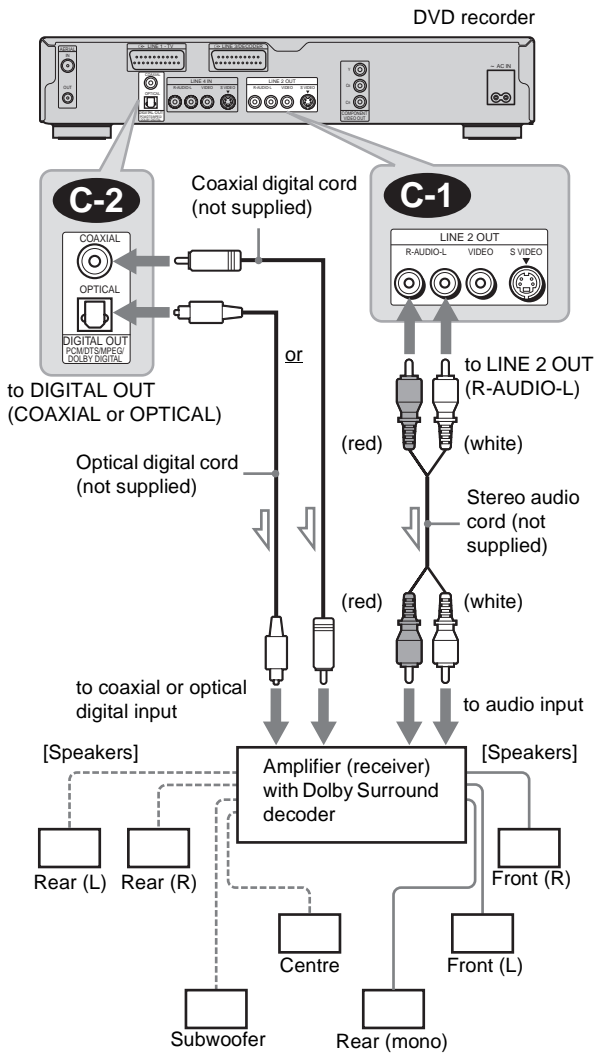

➤ : Signal flow

**Hint**

For correct speaker location, refer to the operating instructions of the connected components.

**Note**

When connecting 6 speakers, replace the monaural rear speaker with a centre speaker, 2 rear speakers, and a subwoofer.

### D Connecting to an AV amplifier (receiver) with a digital input jack and 6 speakers

If your AV amplifier (receiver) has a Dolby Digital, MPEG audio, or DTS decoder and a digital input jack, use this connection. Note that the surround sound effects of this recorder cannot be used with this connection.

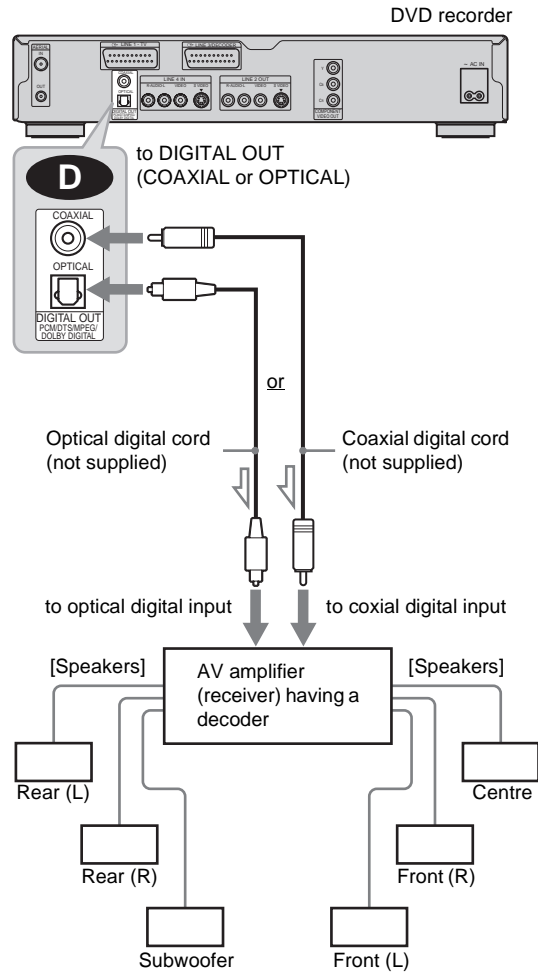

➤ : Signal flow

**Hint**

For correct speaker location, refer to the operating instructions of the connected components.

**Note**

After you have completed the connection, be sure to set “Dolby Digital” to “Dolby Digital” and “DTS” to “On” under “Audio” in Easy Setup (page 13). If your AV amplifier (receiver) has an MPEG audio decoder function, set “MPEG” in “Audio” to “MPEG” (see “AUDIO Settings” in the separate booklet “Operating Instructions”). Otherwise, no sound or a loud noise will come from your speakers.

## Step 5: Connecting the Mains Lead

Connect the supplied mains lead to the AC IN terminal of the recorder. Then plug the recorder and TV mains leads (power cords) into the mains. After you connect the mains lead, **you must wait for a short while before operating the recorder.** You can operate the recorder once the front panel display lights up and the recorder enters standby mode.

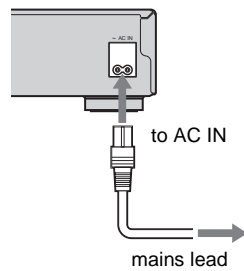

## Step 6: Preparing the Remote

You can control the recorder using the supplied remote. Insert two R6 (size AA) batteries by matching the ⊕ and ⊖ ends on the batteries to the markings inside the battery compartment. When using the remote, point it at the remote sensor  on the recorder.

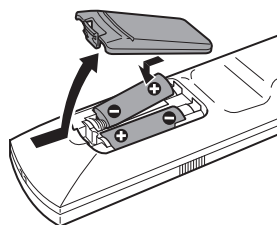

### Notes

- Do not leave the remote in an extremely hot or humid place.
- Do not drop any foreign object into the remote casing, particularly when replacing the batteries.
- Do not expose the remote sensor to direct sunlight or a lighting apparatus. Doing so may cause a malfunction.
- If you do not use the remote for an extended period of time, remove the batteries to avoid possible damage from battery leakage and corrosion.

## If you have a Sony DVD player or more than one Sony DVD recorder

If the supplied remote interferes with your other Sony DVD recorder or player, set the command mode number for this recorder and the supplied remote to one that differs from the other Sony DVD recorder or player.

The default command mode setting for this recorder and the supplied remote is DVD 3.

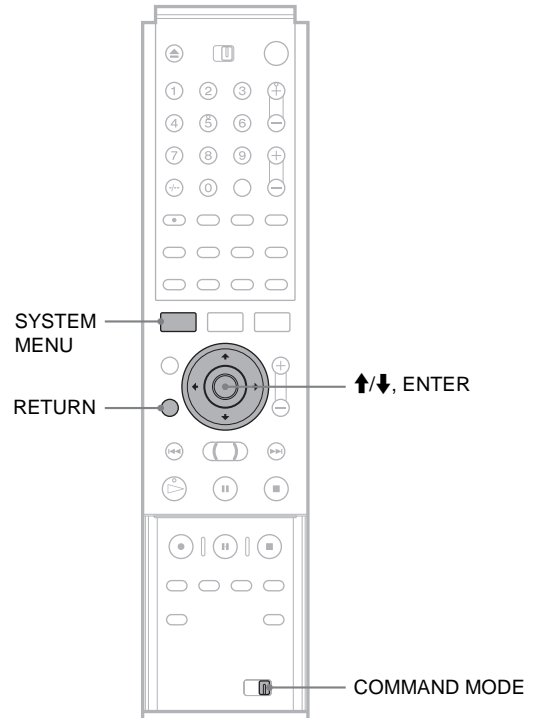

- 1 Press SYSTEM MENU.**  
The System Menu appears.

- 2 Press ↑/↓ to select “SETUP,” then press ENTER.**

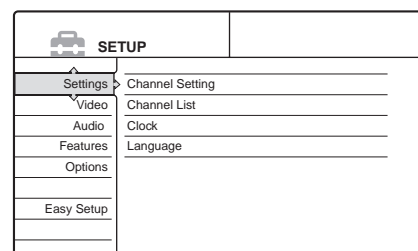

- 3 Press ↑/↓ to select “Options,” then press ENTER.**

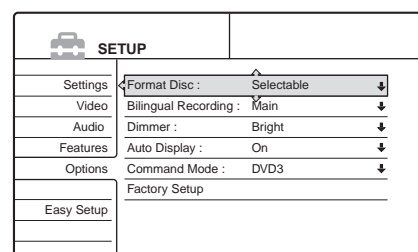

- 4** Press **↑/↓** to select “Command Mode,” then press **ENTER**.

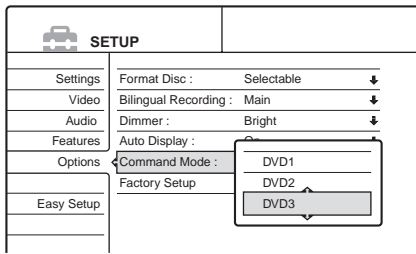

- 5** Press **↑/↓** to select the Command mode (DVD1, DVD2, or DVD3), then press **ENTER**.

- 6** Slide the **COMMAND MODE** switch on the remote so it matches the mode you selected above.

To return to the previous step  
Press **RETURN**.

## Step 7: Easy Setup

Follow the steps below to make the minimum number of basic adjustments for using the recorder. If you do not complete Easy Setup, it will appear each time you turn on your recorder. You will make the settings below in the following order.

OSD Language Setup



Tuner and Channel Setup



Clock Setup



TV Type Setup



Video Connection Setup



Audio Connection Setup

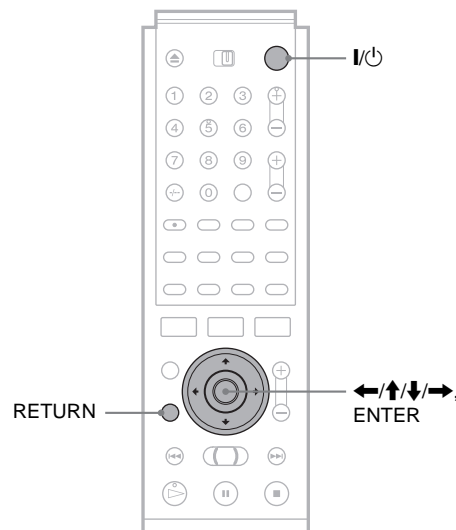

- 1** Turn on the TV.

- 2** Press **I/⏻**.

- 3** Switch the input selector on your TV so that the signal from the recorder appears on your TV screen.

“Initial settings necessary to operate the DVD recorder will be made. You can change them later using Setup.” appears. If this message does not appear, select “Easy Setup” from “SETUP” in the System Menu to run Easy Setup. For details, see “Settings and Adjustments” in the separate booklet “Operating Instructions.”

- 4** Press **ENTER**.

The Setup Display for selecting the language used in the on-screen display appears.

→ continued

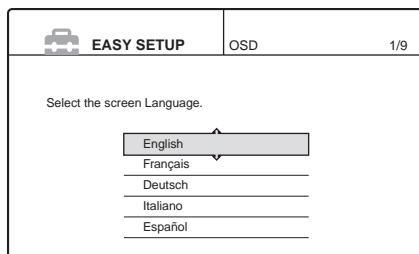

**5** Press **↑/↓** to select a language.

**6** Press **ENTER**.

The setup Display for selecting your country and language for the tuner system appears. The programme order will be set according to the country or language you select.

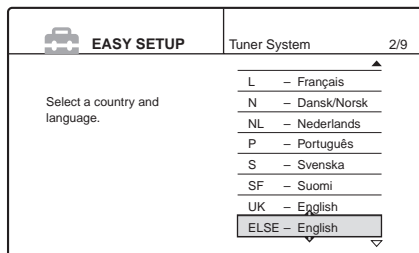

**7** Press **↑/↓** to select your country or language.

If you live in a French speaking country that is not listed on the display, select “ELSE.”

**8** Press **ENTER**.

If you made connection **A** (page 5) and the connected TV complies with SMARTLINK, the Preset Download function automatically starts (page 6).

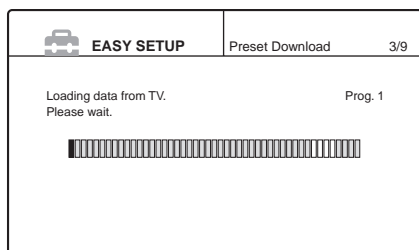

If the Preset Download function does not work or if you made a connection other than **A** (page 5), the Auto Tuner Preset function automatically starts searching for all of the receivable channels and presets them.

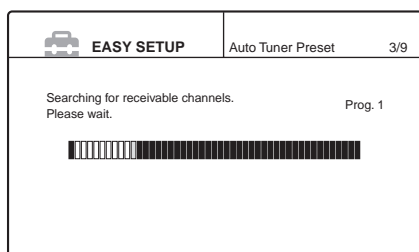

To set the channels manually, see “Presetting channels manually” (page 16).

**9** After the download or search is complete, the Clock function automatically starts.

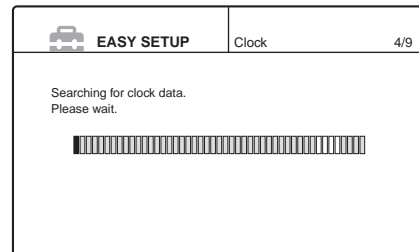

If the current time or date is not set, “The clock was not set automatically. Set the time and date manually.” appears. Set the clock manually using **←/↑/↓/→**, and then press **ENTER**.

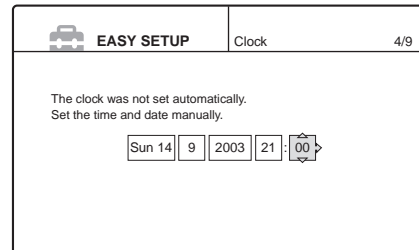

**10** Once the clock signal is received, the Setup Display for selecting the aspect ratio of the connected TV appears.

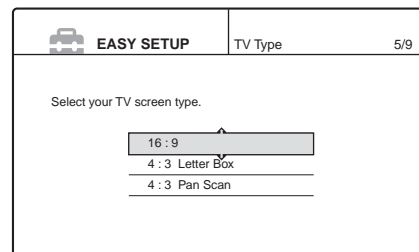

**11** Press **↑/↓** to select the setting that matches your TV type.

- ◆ If you have a wide-screen TV or a 4:3 standard TV with a wide-screen mode
  - 16:9
- ◆ If you have a 4:3 standard TV
  - 4:3 Letter Box  
Displays a wide picture with bands on the upper and lower sections of the screen.
  - 4:3 Pan Scan  
Automatically displays a wide picture on the entire screen and cuts off the sections that do not fit.

For details, see “VIDEO Settings” in the separate booklet “Operating Instructions.”

**12** Press **ENTER**.

The Setup Display for the Component Out jacks appears.

**13** Press **↑/↓** to select an option.

Select “On” if you are using the COMPONENT VIDEO OUT jacks, or select “Off” if you are not using the COMPONENT VIDEO OUT jacks.

**14 Press ENTER.**

The Setup Display for the LINE 3/DECODER jack appears.

**15 Press ↑/↓ to select an option.**

Select “Yes” if you will connect a decoder to the LINE 3/DECODER jack, or select “No” if you will not connect a decoder.

**16 Press ENTER.**

The Setup Display for selecting the type of video signal output from the LINE1-TV jack appears.

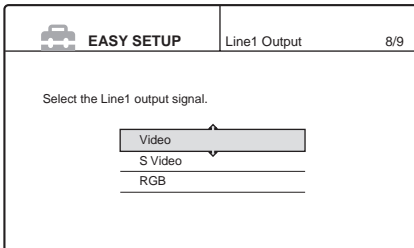

**17 Press ↑/↓ to select the type of signal you want to output from the LINE1-TV jack.**

Note that if you select “On” in step 13, you cannot select “RGB,” and that if you select “Yes” in step 15, you cannot select “S Video.”

- ◆ To output Video signals
  - Video
- ◆ To output S video signals
  - S Video
- ◆ To output RGB signals
  - RGB

If you select “S Video” or “RGB,” SMARTLINK will be deactivated.

**18 Press ENTER.**

The Setup Display for selecting the type of jack used to connect to your amplifier (receiver) appears.

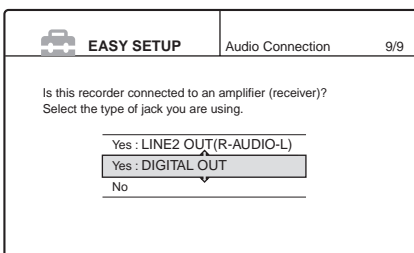

**19 Press ↑/↓ to select the type of jack (if any) you are using to connect to an amplifier (receiver), then press ENTER.**

Choose the item that matches the audio connection you selected on pages 8 to 9 (A through D).

- A**
  - If you connect just a TV and nothing else, select “No,” then go to step 23.
- B-1 C-1**
  - Select “Yes: LINE 2 OUT (R-AUDIO-L),” then go to step 23.
- B-2 C-2 D**
  - Select “Yes: DIGITAL OUT.” The Setup Display for “Dolby Digital” appears.

**20 Press ↑/↓ to select the type of Dolby Digital signal you wish to send to your amplifier (receiver).**

Choose the signal that matches the audio connection you selected on pages 8 to 9 (B through D).

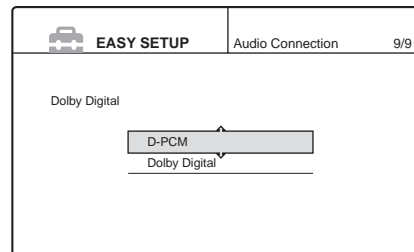

- B-2 C-2**
  - D-PCM
- D**
  - Dolby Digital (only if the amplifier (receiver) has a Dolby Digital decoder)

**21 Press ENTER.**

The Setup Display for selecting the type of DTS signal appears.

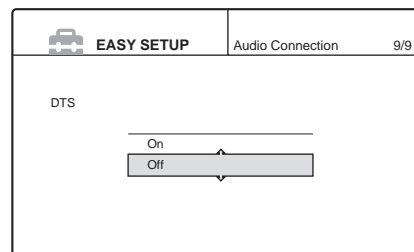

**22 Press ↑/↓ to select the type of DTS signal you wish to send to your amplifier (receiver) and press ENTER.**

Choose the item that matches the audio connection you selected on pages 8 to 9 (B through D).

- B-2 C-2**
  - Off
- D**
  - On (only if the amplifier (receiver) has a DTS decoder)

**23 Press ENTER when “Finish” appears.**

Easy Setup is finished. All connections and setup operations are complete.

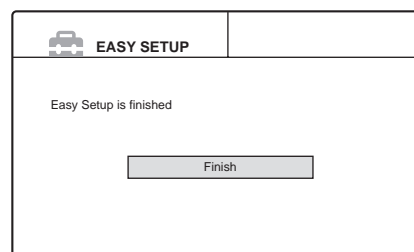

**To return to the previous step**

Press RETURN.

**Hints**

- If your AV amplifier (receiver) has an MPEG audio decoder, set “MPEG” to “MPEG” (see “AUDIO Settings” in the separate booklet “Operating Instructions”).
- If you want to run Easy Setup again, select “Easy Setup” from “Setup” in the System Menu.

# Advanced Hookups and Settings

## Setting the Clock

You must set the time and date on the recorder to use the timer features properly.

The Auto Clock Set function works only if a station in your area is broadcasting a time signal. If the Auto Clock Set function did not set the clock correctly for your local area, try another station for the Auto Clock Set function or set the clock manually.

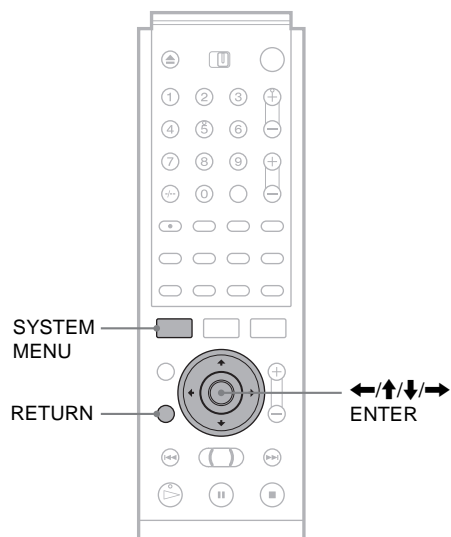

### Changing the station for the Auto Clock Set function

**1 Press SYSTEM MENU.**

The System Menu appears.

**2 Press ↑/↓ to select “SETUP,” then press ENTER.**

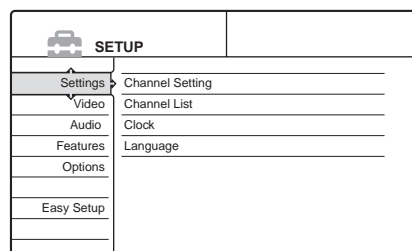

**3 Press ↑/↓ to select “Settings,” then press ENTER.**

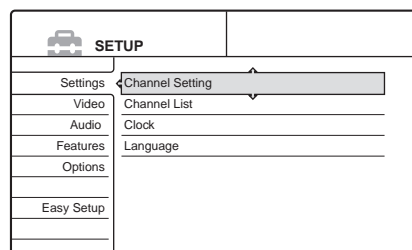

- Setting the Clock. . . . . page 14
- Presetting Channels . . . . . page 16
- Changing/Disabling the Channels . . . . . page 19
- Controlling Your TV or AV Amplifier (Receiver) . . . . . page 21
- Connecting a VCR or Similar Recording Device to the LINE3 Jack . . . . . page 22
- Connecting to a Satellite or Digital Tuner . . . . . page 23
- Connecting a PAY-TV/Canal Plus Decoder . . . . . page 24

- Press **↑/↓** to select “Clock,” then press **ENTER**.

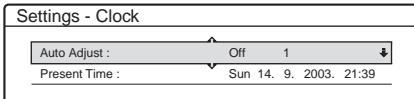

- Press **↑/↓** to select “Auto Adjust,” then press **ENTER**.

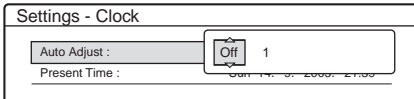

- Press **↑/↓** to select “On,” then press **→**.

- Press **↑/↓** repeatedly until the programme position of the station that carries a time signal appears, then press **ENTER**.

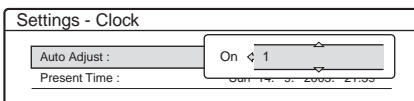

If the recorder does not receive a time signal from any station, “Auto Adjust” returns to “Off” automatically and the menu for setting the clock manually appears on the screen.

- Press **SYSTEM MENU** repeatedly to exit the menu.

### To return to the previous step

Press **RETURN**.

#### Hint

If you set “Auto Adjust” to “On,” the Auto Clock Set function is activated whenever the recorder is turned off. The time is adjusted automatically by receiving the time signal from the station displayed in the “Auto Adjust” row.

## Setting the clock manually

- Press **SYSTEM MENU**.  
The System Menu appears.

- Press **↑/↓** to select “SETUP,” then press **ENTER**.

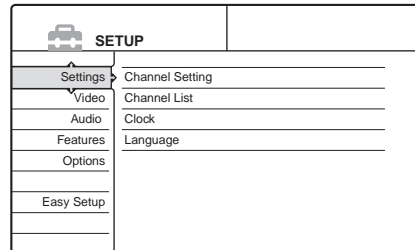

- Press **↑/↓** to select “Settings,” then press **ENTER**.

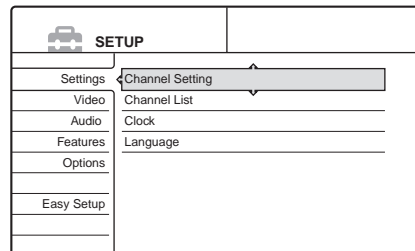

- Press **↑/↓** to select “Clock,” then press **ENTER**.

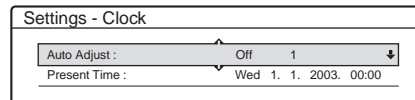

- Press **↑/↓** to select “Auto Adjust,” then press **ENTER**.

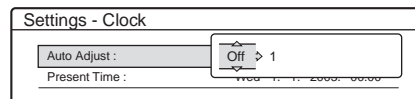

- Press **↑/↓** to select “Off,” then press **ENTER**.

- Press **↑/↓** to select “Present Time,” then press **ENTER**.

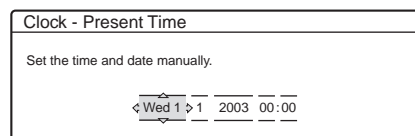

- Press **↑/↓** to set the day, then press **→**.  
Set the month, year, hour, and minutes in sequence. Press **←/→** to select the item to be set, then press **↑/↓** to set the numbers. The day of the week is set automatically.

- Press **ENTER** to start the clock.

→ continued

**10** Press **SYSTEM MENU** repeatedly to exit the menu.

**To return to the previous step**

Press **RETURN**.

**Hint**

To change the numbers in step 8, press **←** to return to the item to be changed, and select the numbers by pressing **↑/↓**.

# Presetting Channels

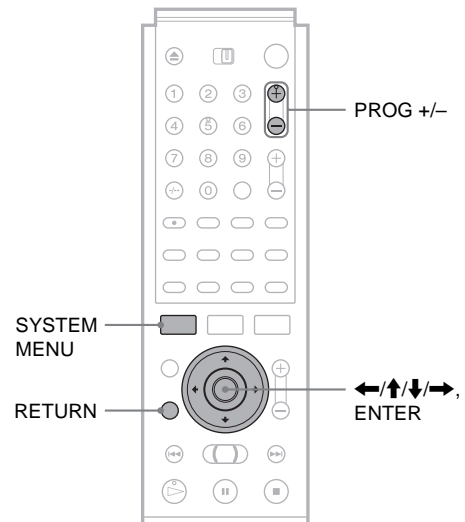

## Presetting channels manually

If some channels could not be set using the Easy Setup function, you can set them manually.

If there is no sound or if the picture is distorted, the wrong tuner system may have been preset during Easy Setup. Set the correct tuner system manually in the steps below.

**1** Press **SYSTEM MENU**.

The System Menu appears.

**2** Press **↑/↓** to select “**SETUP**,” then press **ENTER**.

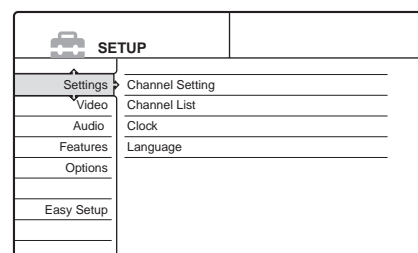

**3** Press **↑/↓** to select “**Settings**,” then press **ENTER**.

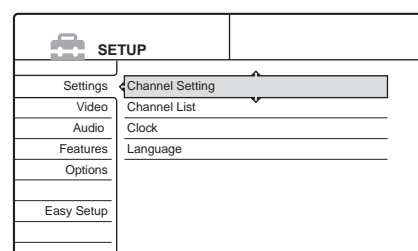



- 4** Press **↑/↓** to select “Channel Setting,” then press **ENTER**.

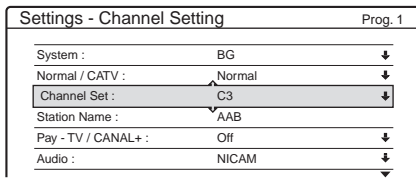

- 5** Press **PROG +/-** to select the programme position.

Selected programme position

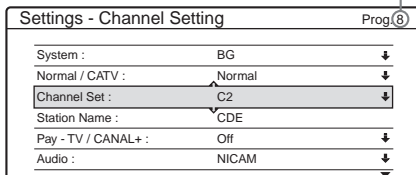

- 6** Press **↑/↓** to select “System,” then press **ENTER**.

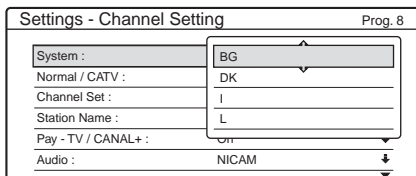

- 7** Press **↑/↓** to select an available TV system, BG, DK, L, or I, then press **ENTER**.

- 8** Press **↑/↓** to select “Normal/CATV,” then press **ENTER**.

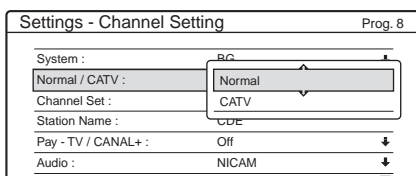

- 9** Press **↑/↓** to select “Normal,” then press **ENTER**.

To set CATV (Cable Television) channels, select “CATV.”

- 10** Press **↑/↓** to select “Channel Set,” then press **ENTER**.

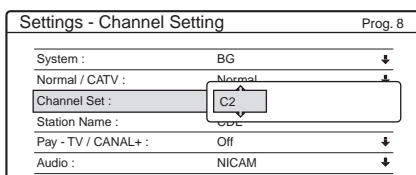

- 11** Press **↑/↓** repeatedly until the channel you want is displayed, then press **ENTER**.

The channels are scanned in the order shown in the table below.

If you know the number of the channel you want, press the number buttons. For example, for channel 5, first press “0” and then press “5.” Then press **ENTER**.

- 12** Press **↑/↓** to select “Audio,” then press **ENTER**.

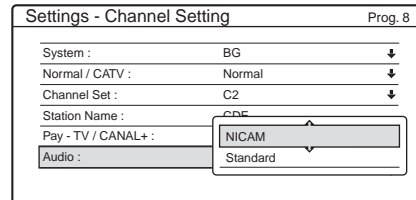

- 13** Press **↑/↓** to select “NICAM,” then press **ENTER**.

- 14** To set another programme position, repeat steps 5 through 13.

- 15** Press **SYSTEM MENU** repeatedly to exit the menu.

### Receivable Channels

TV system	Channel coverage
BG (West European Countries, except those listed below)	E2 - E12 VHF
	Italia A - H VHF
	E21 - E69 UHF
	S1 - S20 CATV
	S21 - S41 HYPER
DK (East European Countries)	S01 - S05 CATV
	R1 - R12 VHF
	E21 - E69 UHF
	S1 - S20 CATV
	S21 - S41 HYPER
L (France)	S01 - S05 CATV
	F2 - F10 VHF
	F21 - F69 UHF
	B - Q CATV
	S21 - S41 HYPER
I (Great Britain/Ireland)	S01 - S05 CATV
	Ireland A - J VHF
	South Africa 4 - 13 VHF
	B21 - B69 UHF
	S1 - S20 CATV
S21 - S41 HYPER	
S01 - S05 CATV	

### To return to the previous step

Press **RETURN**.

#### Hint

If the sound is not clear when listening to NICAM broadcasts, set “Audio” explained above to “Standard.”

## If the picture is not clear

If the Auto Fine Tuning (AFT) function does not effectively tune the picture of a certain station, you will need to adjust the pictures manually.

- 1 Press **PROG +/-** or the number buttons to select the programme position for which you cannot obtain a clear picture.

- 2 Press **SYSTEM MENU**.  
The System Menu appears.

- 3 Press **↑/↓** to select “**SETUP**,” then press **ENTER**.

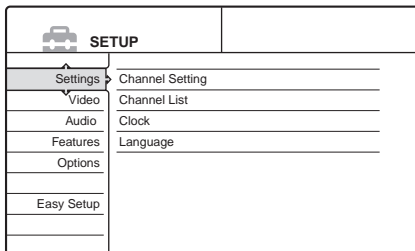

- 4 Press **↑/↓** to select “**Settings**,” then press **ENTER**.

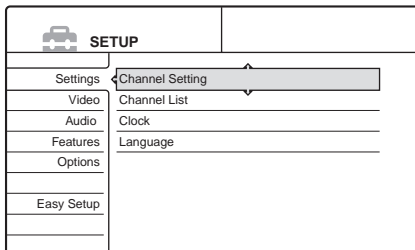

- 5 Press **↑/↓** to select “**Channel Setting**,” then press **ENTER**.

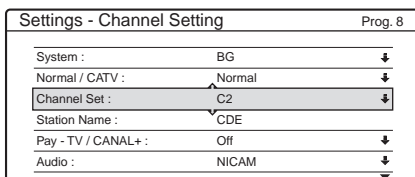

- 6 Press **↑/↓** to select “**AFT**,” then press **ENTER**.

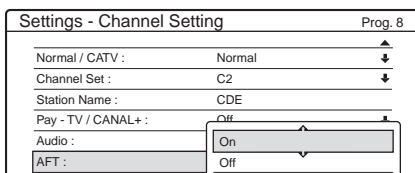

- 7 Press **↑/↓** to select “**Off**,” then press **ENTER**.

The fine tuning bar appears.



- 8 Press **←/→** to get a clearer picture, then press **ENTER**.

- 9 Press **SYSTEM MENU** repeatedly to exit the menu.

To return to the previous step

Press **RETURN**.

### Note

While adjusting the picture, the display may become difficult to read due to interference from the picture being received.

# Changing/Disabling the Channels

After setting the channels, you can change the programme positions. If any programme positions are unused or contain unwanted channels, you can disable them. You can also change the station names. If the station names are not displayed, you can enter them manually.

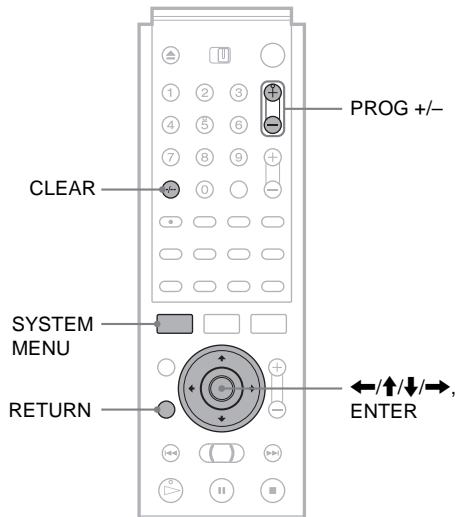

## Changing or disabling programme positions

- 1 Press SYSTEM MENU.**  
The System Menu appears.
- 2 Press  $\uparrow/\downarrow$  to select "SETUP," then press ENTER.**

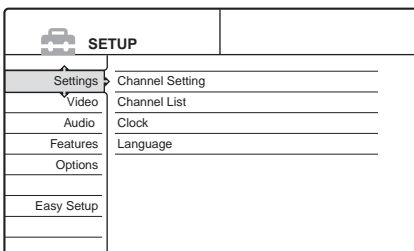

- 3 Press  $\uparrow/\downarrow$  to select "Settings," then press ENTER.**

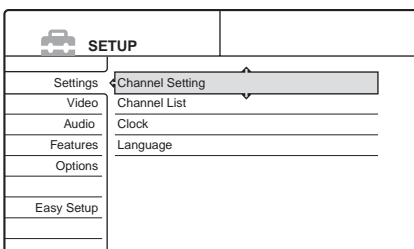

- 4 Press  $\uparrow/\downarrow$  to select "Channel List," then press ENTER.**

Prog	Channel	Name
1	C3	AAB
2	C5	FGH
3	C12	
4	C21	
5	C23	
6	C24	PQR

- 5 Press  $\uparrow/\downarrow$  to select the row containing the programme position you want to change or disable.**

◆ **To change**

Press ENTER and go to step 6.

◆ **To disable**

Press CLEAR and go to step 8. The disabled positions will be skipped when you press the PROG +/- buttons.

To display other pages for programme positions 7 to 99, press  $\uparrow/\downarrow$  repeatedly.

- 6 Press  $\uparrow/\downarrow$  until the selected channel row moves to the desired programme position.**

The selected channel is inserted at the new programme position.

Prog	Channel	Name
1	C3	AAB
2	C12	
3	C21	
4	C5	FGH
5	C23	
6	C24	PQR

- 7 Press ENTER to confirm the setting.**

- 8 To change or disable the programme position of another station, repeat steps 5 through 8.**

- 9 Press SYSTEM MENU repeatedly to exit the menu.**

### To return to the previous step

Press RETURN.

### Note

Be sure to select the programme position you want to disable correctly. If you disable a programme position by mistake, you need to reset that channel manually (*page 16*).

## Changing the station names

You can change or enter a station name (up to 5 characters). The recorder must receive channel information (for instance, SMARTLINK information) for station names to appear automatically.

### 1 Press SYSTEM MENU.

The System Menu appears.

### 2 Press $\uparrow/\downarrow$ to select "SETUP," then press ENTER.

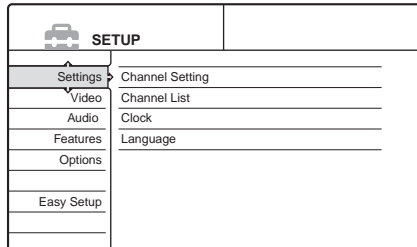

### 3 Press $\uparrow/\downarrow$ to select "Settings," then press ENTER.

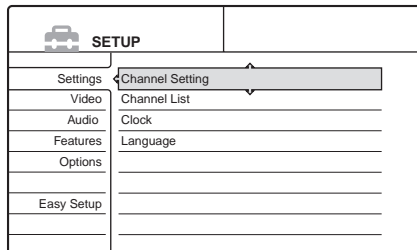

### 4 Press $\uparrow/\downarrow$ to select "Channel Setting," then press ENTER.

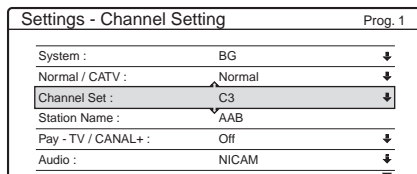

### 5 Press PROG +/- to select the programme position for which you want to change or enter a station name.

### 6 Press $\uparrow/\downarrow$ to select "Station Name," then press ENTER.

The display for entering characters appears.

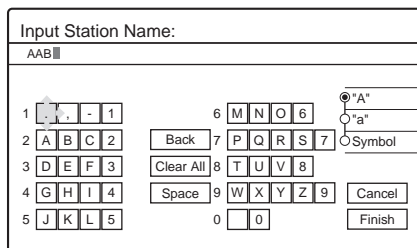

#### ◆ To enter a character

① Press  $\leftarrow/\uparrow/\downarrow/\rightarrow$  to move the cursor to the right of the screen and select "A"(upper case), "a"(lower case), or "Symbol," then press ENTER.

② Press  $\leftarrow/\uparrow/\downarrow/\rightarrow$  to select the character you want to enter, then press ENTER.

The selected character appears at the top of the display.

③ Repeat steps ① and ② to enter all of the characters for the station name.

#### ◆ To erase a character

① Press  $\leftarrow/\uparrow/\downarrow/\rightarrow$  to move the cursor to the input row.

② Press  $\leftarrow/\rightarrow$  to move the cursor to the right of the character you want to erase.

③ Press  $\leftarrow/\uparrow/\downarrow/\rightarrow$  to select "Back," then press ENTER.

#### ◆ To insert a character

① Press  $\leftarrow/\uparrow/\downarrow/\rightarrow$  to move the cursor to the input row.

② Press  $\leftarrow/\uparrow/\downarrow/\rightarrow$  to move the cursor to the right of the point where you want to insert a character.

③ Press  $\leftarrow/\uparrow/\downarrow/\rightarrow$  to select the character you want to insert, then press ENTER.

#### ◆ To erase all of the characters

Press  $\leftarrow/\uparrow/\downarrow/\rightarrow$  to select "Clear All," then press ENTER.

For details, see "Guide to Displays" in the separate booklet "Operating Instructions".

### 7 Press $\leftarrow/\uparrow/\downarrow/\rightarrow$ to select "Finish," then press ENTER.

### 8 Press SYSTEM MENU repeatedly to exit the menu.

To return to the previous step

Press RETURN.

# Controlling Your TV or AV Amplifier (Receiver)

You can control your TV with the supplied remote by adjusting the remote control's signal.  
 If you connected the recorder to an AV amplifier (receiver), you can also control the volume with the supplied remote.

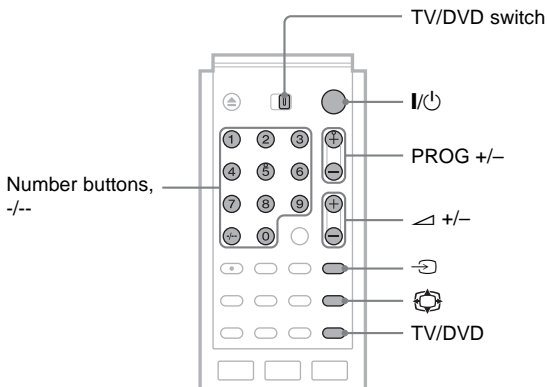

### Notes

- Depending on the connected unit, you may not be able to control your TV or AV amplifier (receiver) with some or all of the buttons below.
- If you enter a new code number, the code number previously entered will be erased.
- When you replace the batteries of the remote, the code number may be reset to the default setting. Set the appropriate code number again.

## Controlling TVs with the remote

- 1** Slide the TV/DVD switch to TV.
- 2** Hold down I/⏻.
- 3** Enter your TV's manufacturer code (see "Code numbers of controllable TVs" below) using the number buttons.
- 4** Release I/⏻.  
 When the TV/DVD switch is set to TV, the remote performs the following:

I/⏻	Turns your TV on or off
∧ (volume) +/-	Adjusts the volume of your TV
⊞ (wide mode)	Switches to or from the wide mode of a wide-screen TV
↺ (TV/video)	Switches your TV's input source
PROG +/-, Number buttons, -/--*	Selects the programme position on your TV

\* If you use number buttons to select the TV's programme position, press -/-- followed by the number buttons for two-digit numbers.

## To operate the TV/DVD button (for SCART connections only)

The TV/DVD button switches between the recorder and the last input source selected on the TV. Point your remote at the recorder when using this button. The button works even if the TV/DVD switch is set to DVD.

When you connect the recorder to the TV via the SCART (EURO AV) jacks, the input source for the TV is set to the recorder automatically when you start playback. To watch another source, press the TV/DVD button to switch the TV's input source.

## Code numbers of controllable TVs

If more than one code number is listed, try entering them one at a time until you find the one that works with your TV.

Manufacturer	Code number
Sony	01 (default)
Aiwa	01 (default)
Grundig	11
Hitachi	24
Loewe	08, 45
Nokia	15, 16, 69
Panasonic	17, 49
Philips	06, 07, 08
Saba	12, 13
Samsung	06, 22, 23
Sanyo	25
Sharp	29
Telefunken	36
Thomson	43
Toshiba	38

## Controlling the volume of your AV amplifier (receiver) with the remote

- 1** Slide the TV/DVD switch to DVD.
- 2** Hold down **I/⏻**, and enter the manufacturer code (see the table below) for your AV amplifier (receiver) using the number buttons.
- 3** Release **I/⏻**.  
The **∇** (volume) +/- buttons control the AV amplifier's volume.
  - ◆ **If you want to control the TV's volume**  
Slide the TV/DVD switch to TV.

### 💡 Hint

If you want to control the TV's volume even when the TV/DVD switch is set to DVD, repeat the steps above and enter the code number 90 (default).

## Code numbers of controllable AV amplifiers (receivers)

If more than one code number is listed, try entering them one at a time until you find the one that works with your AV amplifier (receiver).

Manufacturer	Code number
Sony	80, 88, 89, 91
Denon	84, 85, 86
Kenwood	92, 93
Onkyo	81, 82, 83
Pioneer	99
Sansui	87
Technics	97, 98
Yamaha	94, 95, 96

### Note

If you cannot control the volume of your Sony AV amplifier (receiver) with the remote, try entering the code number 91, and change the command mode of your amplifier (receiver) to "COMMAND MODE [AV1]" (not all amplifiers have this option). See the instructions supplied with your amplifier (receiver) to change the command mode.

## Connecting a VCR or Similar Recording Device to the LINE3 Jack

You can use this recorder as the source player or as the recording deck. See "Recording From Equipment Connected to the LINE IN Jacks" in the separate booklet "Operating Instructions" when connecting to the LINE 2 IN or LINE 4 IN jacks. Disconnect the recorder's mains lead from the mains when connecting the VCR or recording device.

### How to connect to record

Connect a VCR or similar recording device to the LINE 3/DECODER jack of this recorder. Then press INPUT SELECT to select "L3." You are ready to start recording.

If you are using this recorder as the recording deck, see "Recording from Equipment Connected to the LINE IN jacks" in the separate booklet "Operating Instructions."

If you are using this recorder as the source player, refer to the instructions of the connected device for recording instructions.

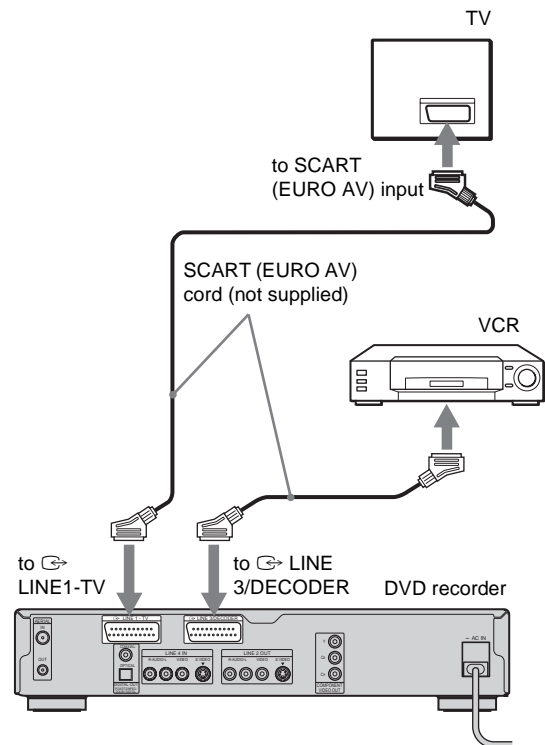

### 💡 Hint

If you are using another recorder with S VIDEO and AUDIO IN/OUT jacks, you can connect those jacks to this recorder's S VIDEO and R-AUDIO-L IN/OUT jacks.

### Notes

- If you pass the recorder signals via the VCR, you may not receive a clear image on the TV screen.



- SMARTLINK features are not available for devices connected via the DVD recorder's LINE 3/DECODER jack.
- Pictures containing copy protection signals that prohibit any copying cannot be recorded.

- When you record to a VCR from this DVD recorder, do not switch the input source to TV by pressing the TV/DVD button on the remote.
- If you disconnect the recorder's AC power cord, you will not be able to view the signals from the connected VCR.

# Connecting to a Satellite or Digital Tuner

Connect a satellite or digital tuner to this recorder using the LINE 3/DECODER jack. Disconnect the recorder's mains lead from the mains when connecting the tuner.

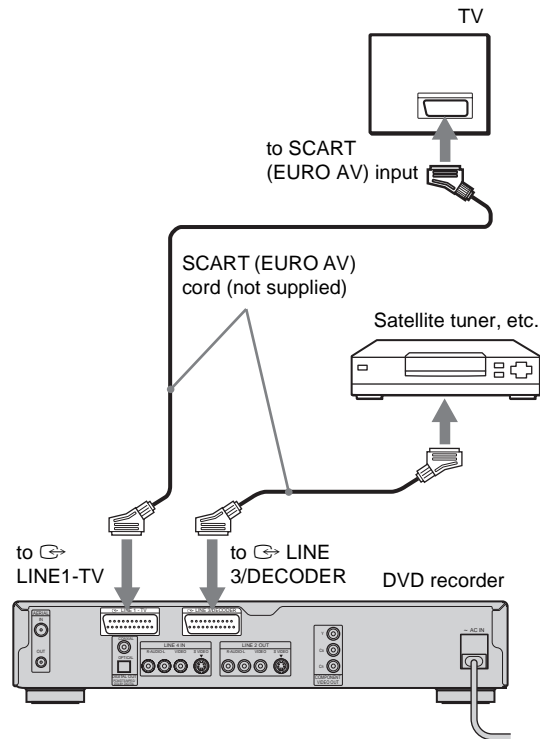

## If the satellite tuner can output RGB signals

This recorder accepts RGB signals. If the satellite tuner can output RGB signals, connect the TV SCART connector on the satellite tuner to the LINE 3/DECODER jack, and set "Line3 Input" of "Scart Setting" to "Video/RGB." see "VIDEO Settings" in the separate booklet "Operating Instructions." Note that this connection and setup disables the SMARTLINK function.

## If you want to use the Synchro Rec function

This connection is necessary to use the Synchronized Recording function. see "Recording from External Equipment with a Timer (Synchro Rec)" in the separate booklet "Operating Instructions."

Set "Line3 Input" of "Scart Setting" according to the specifications of your satellite tuner. Refer to your satellite tuner's instructions for more information.

### ◆ If you are using a B Sky B tuner

Be sure to connect the tuner's VCR SCART jack to the LINE 3/DECODER jack. Then set "Line3 Input" of "Scart Setting" according to the specifications of the VCR SCART jack on your satellite tuner.

### Notes

- Do not set "Line3 Input" of "Scart Setting" in "Video" to "Decoder."
- Synchronized Recording does not work with some tuners. For details, refer to the tuner's operating instructions.
- If you disconnect the recorder's mains lead, you will not be able to view the signals from the connected tuner.

# Connecting a PAY-TV/ Canal Plus Decoder

You can watch or record PAY-TV/Canal Plus programmes if you connect a decoder (not supplied) to the recorder. Disconnect the recorder's mains lead from the mains when connecting the decoder.

## Connecting a decoder

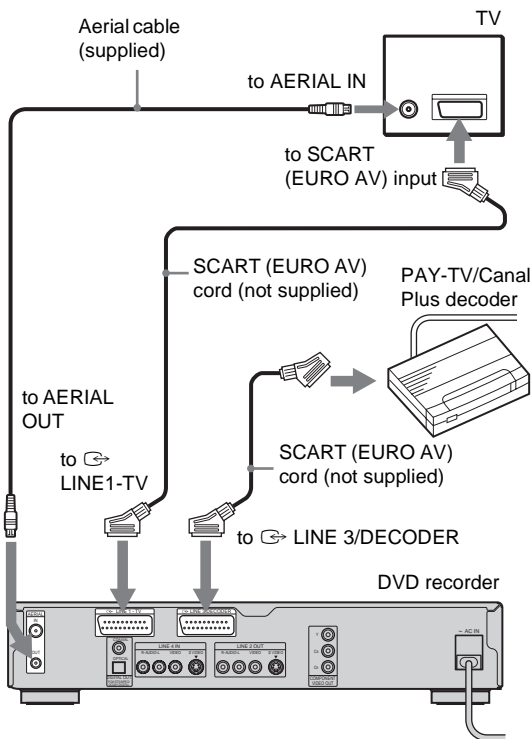

## Setting PAY-TV/Canal Plus channels

To watch or record PAY-TV/Canal Plus programmes, set your recorder to receive the channels using the on-screen display. In order to set the channels correctly, be sure to follow all of the steps below.

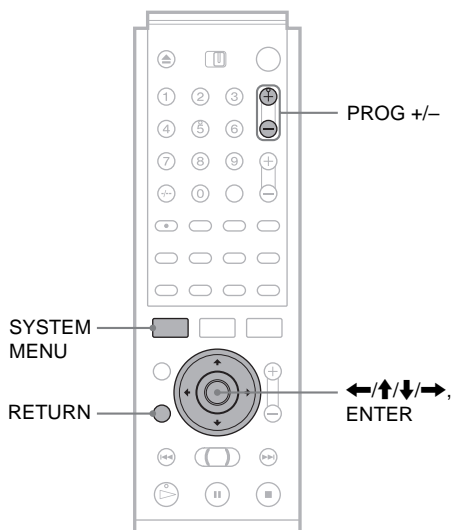

### 1 Press **SYSTEM MENU**.

The System Menu appears.

### 2 Press **↑/↓** to select “**SETUP**,” then press **ENTER**.

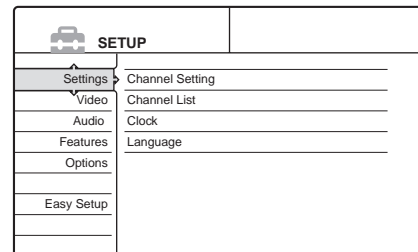

### 3 Press **↑/↓** to select “**Video**,” then press **ENTER**.

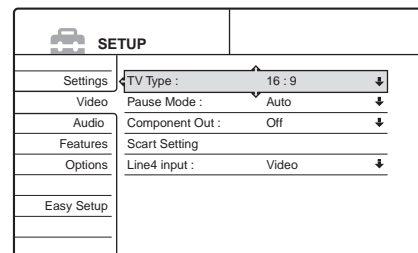

### 4 Press **↑/↓** to select “**Scart Setting**,” then press **ENTER**.

Video - Scart Setting		
Line1 Output	Line3 Input	Line3 Output
Video	Video/RGB	Video
Video	Video/RGB	S Video
Video	Decoder	Video
S Video	S Video	Video
S Video	S Video	S Video
RGB	Video/RGB	Video

### 5 Press **↑/↓** to select “**Video**” or “**RGB**” for “**Line1 Output**,” “**Decoder**” for “**Line3 Input**” and “**Video**” for “**Line3 Output**,” then press **ENTER**.

Video Setup appears again.

### 6 Press **RETURN** to return the cursor to the left column.

### 7 Press **↑/↓** to select “**Settings**,” then press **ENTER**.

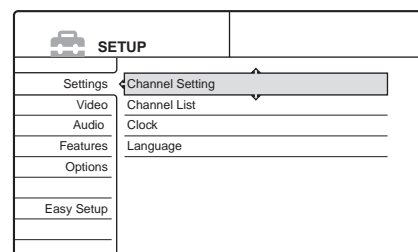



- 8** Press **↑/↓** to select “Channel Setting,” then press **ENTER**.

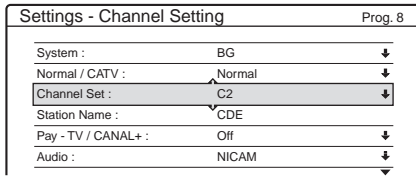

- 9** Press **PROG +/-** to select the desired programme position.

Selected programme position

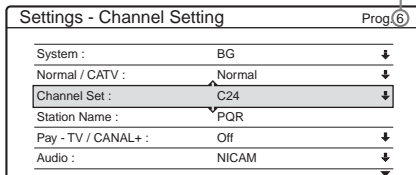

- 10** Press **↑/↓** to select “System,” then press **ENTER**.

- 11** Press **↑/↓** to select an available TV system, **BG, DK, L, or I**, then press **ENTER**.  
To receive broadcasts in France, select **L**.

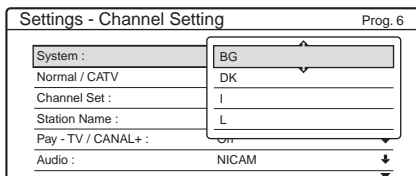

- 12** Press **↑/↓** to select “Normal/CATV,” then press **ENTER**.

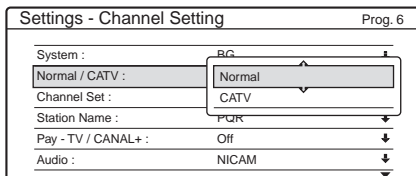

- 13** Press **↑/↓** to select “Normal,” then press **ENTER**.

To preset CATV (Cable Television) channels, select “CATV.”

- 14** Press **↑/↓** to select “Channel Set,” then press **ENTER**.

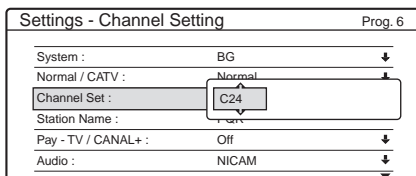

- 15** Press **↑/↓** to select the **PAY-TV/Canal Plus** channel, then press **ENTER**.

- 16** Press **↑/↓** to select “PAY-TV/CANAL+,” then press **ENTER**.

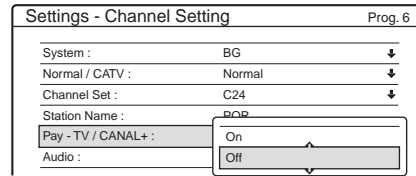

- 17** Press **↑/↓** to select “On,” then press **ENTER**.

- 18** Press **SYSTEM MENU** repeatedly to exit the menu.

To return to the previous step

Press **RETURN**.

#### Notes

- When you set “Line3 Input” to “Decoder” in step 5 above, you will not be able to select “L3” because Line 3 will become a dedicated line for the decoder.
- If you disconnect the recorder’s mains lead, you will not be able to view the signals from the connected decoder.

# Index

Words in quotations appear in the on-screen displays.

## Numerics

16:9 12  
4:3 Letter Box 12  
4:3 Pan Scan 12

## A

AFT (Auto Fine Tuning) 18  
"Audio" 17  
"Audio Connection" 11  
"Auto Adjust" 15  
Auto Clock Set 14

## B

Batteries 10

## C

Canal Plus 24  
"CATV" 17, 25  
"Channel List" 19  
"Channel Set" 17, 25  
"Channel Setting" 17, 18, 20, 25  
"Clock" 12, 15  
Clock setting 14  
"Command Mode" 11  
"Component Out" 12  
Connecting  
    the Aerial Cable 5  
    the Audio Cords 7  
    the Video Cords 5

## D

"Decoder" 24  
Dolby Digital 9, 13  
DTS 9, 13

## E

Easy Setup 11

## L

"Line1 Output" 5, 24  
"Line3 Input" 23, 24

## M

MPEG 9

## N

"NICAM" 17  
"Normal" 17, 25

## O

"Options" 10  
"OSD" language 11

## P

PAY-TV 24  
"Present Time" 15  
"Preset Download" 12  
Pro Logic 9

## R

Remote 10  
"RGB" 5, 13

## S

"S Video" 5, 13  
"Scart Setting" 23, 24  
"Settings" 14, 16, 19, 24  
"Setup" 10, 14, 16, 19, 24  
SMARTLINK 6  
"Station Name" 20  
"System" 17, 25  
System Menu 10, 14, 16, 19, 24

## T

"Tuner System" 12  
"TV Type" 12

## V

"Video" 13, 24

When you have finished with hookups and settings, refer to the Operating Instructions for further instructions. "Troubleshooting," "Specifications," and "Guide to Parts and Controls" can also be found in the Operating Instructions.



<http://www.sony.net/>



Printed on 100% recycled paper using  
VOC (Volatile Organic Compound)-  
free vegetable oil based ink.

Sony Corporation