



S1931a, S2031/S2031a,
S2231/S2231a, S2331/ S2331a , S2321a,
LCD Monitors
User Guide

© 2010 Hewlett-Packard Development Company, L.P.

Microsoft, Windows, and Windows Vista are either trademarks or registered trademarks of Microsoft Corporation in the United States and/or other countries.

The only warranties for HP products and services are set forth in the express warranty statements accompanying such products and services. Nothing herein should be construed as constituting an additional warranty. HP shall not be liable for technical or editorial errors or omissions contained herein. This document contains proprietary information that is protected by copyright. No part of this document may be photocopied, reproduced, or translated to another language without the prior written consent of Hewlett-Packard Company.

Second Edition (March 2010)

Document Part Number: 603307-002

Important Safety Instructions

1. Please read all the following instructions carefully and keep this manual for future reference.
2. Unplug this monitor before cleaning. Do not use liquids or aerosol cleaners to clean the surface of the LCD. Use a damp cloth for cleaning.
3. Do not push the surface of the LCD screen with your hands or any hard article. It may cause damage to the circuit or liquid crystal molecules inside the monitor.
4. Do not expose the equipment to water, rain or moisture.
5. Do not place the product on any unstable cart, stand or table, shelves etc. It may fall, causing serious damage to itself.
6. Do not block or cover the openings for ventilation with any clothing or sheath. Do not place the equipment near a radiator or electrical heater or within a closed space, such as a bookcase, without proper ventilation.
7. Do not place anything on the power cord. Do not locate the power cord where it will be abused by persons walking on it.
8. Never insert any object into this monitor through cabinet slots as it may touch dangerous high-voltage points or cause short circuit, resulting in fire or electric shock. Never spill liquid of any kind on the monitor.
9. Follow the suggested resolution of the monitor to decide the resolution setting in the computer to enable optimum display.
10. Avoid displaying the same image on the screen of the monitor for a long time. Otherwise, it may cause aging liquid crystal molecules inside the monitor and poor display.
11. Unplug the monitor to prolong its life cycle when it has been unused for a long time.
12. Do not attempt to service this monitor yourself since opening or removing the covers may expose you to dangerous voltage or other hazards. Refer all servicing to qualified service engineer.
13. Unplug the monitor and take it to the manufacturer's service personnel under the following circumstances:
 - a. When the power cord or plug is damaged or frayed.
 - b. If liquid has been spilled into the monitor.
 - c. If the monitor has been exposed to rain or water.
 - d. If the monitor has been dropped or the cabinet has been damaged.
 - e. When the monitor exhibits a distinct change in performance and servicing is needed.

Chapter I. Introduction

1.1 Features

- ☑ Multilingual OSD adjustment
- ☑ Compatible with IBM VGA, extended VGA, VESA VGA, SVGA, XGA, and SXGA modes
- ☑ Wide range of applicable voltages (AC 100-240V 50/60Hz) enables direct use without any setting.
- ☑ Plug-and-play VESA DDC1/ 2B Standard. Compatible with Windows 9x / 2000 / xp / Vista operation systems

1.2 Check list

Please make sure the following items are included with your LCD monitor;

- ☑ The monitor (and the pedestal)
- ☑ Lower stand
- ☑ Power cord
- ☑ Signal cord
- ☑ User manual
- ☑ Fast installation manual
- ☑ Warranty certificate
- ☑ Audio cable (select models)
- ☑ DVI Cable (select models)

If any of these items are missing, please contact your dealer for technical support and custom service.

Note: Be sure to save original box and all packing materials for future transport.

Chapter II. Installation

2.1 Install the pedestal

Please follow the steps illustrated below to install the pedestal.

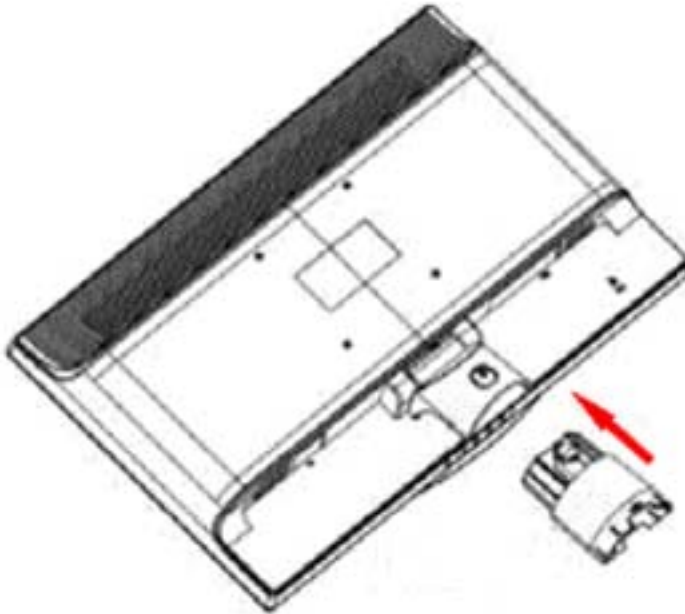

Step 1

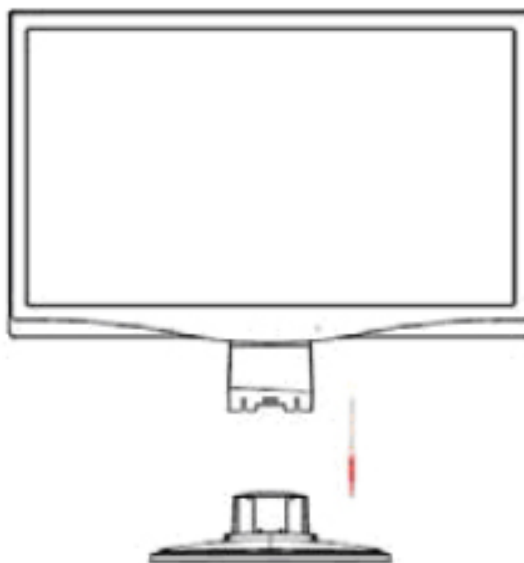

Step 2

2.2 Connect your monitor to your computer

1. Power off and unplug your computer.
2. Connect the 15-Pin or 24-Pin ends of the signal cable to the VGA or DVI port of your monitor and the VGA or DVI OUT jack on the back of your computer. Secure the screws on both ends of the signal cable.
3. Connect the power cords of your computer and monitor to the nearest electrical outlet.
4. Power on your computer and monitor. If your monitor displays an image, the installation has been successfully done. If the monitor does not display any image, check all the connections.

- Cautions:
1. For installation, please complete signal cord connection before plugging the power cord into the electrical outlet to avoid damaging the monitor.
 2. During installation, please support the front frame with your hand at its center of gravity to avoid dropping and damaging the monitor.

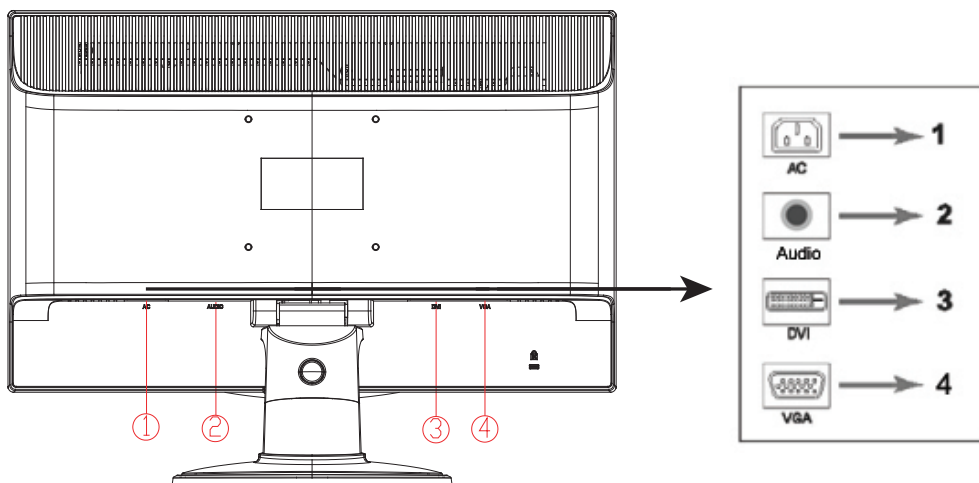

Overview of the ports of the monitor:

1. AC power supply input
2. Audio signal input (select models)
3. DVI signal input
4. VGA signal input

Connecting the Audio Cable (Select Models)

Connect the built-in monitor speakers to the computer and to the audio connector on the rear of the monitor by using the audio cable (provided with select models).

2.3 Disconnect the pedestal

1. Press the clip button on the pedestal and remove the pedestal from the stand.

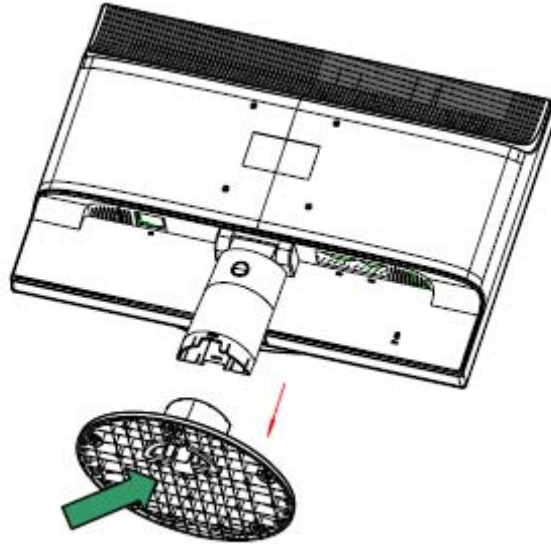

2. Press the clip button on the stand and remove the pedestal from your LCD monitor.

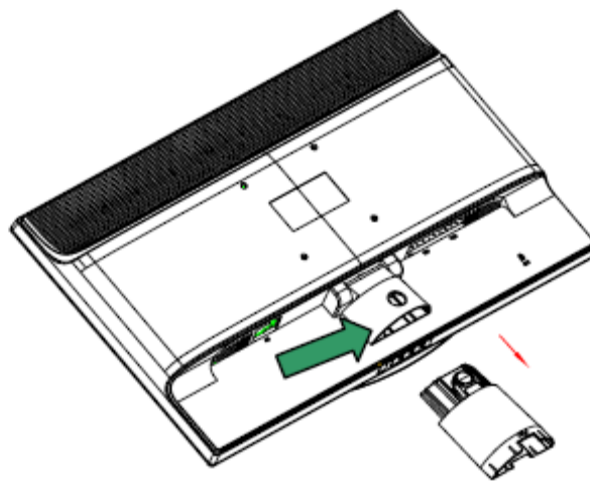

Note: This monitor uses VESA-compatible 100mmx100mm installation ports.

Chapter III. Monitor overview

Overview of front panel controls

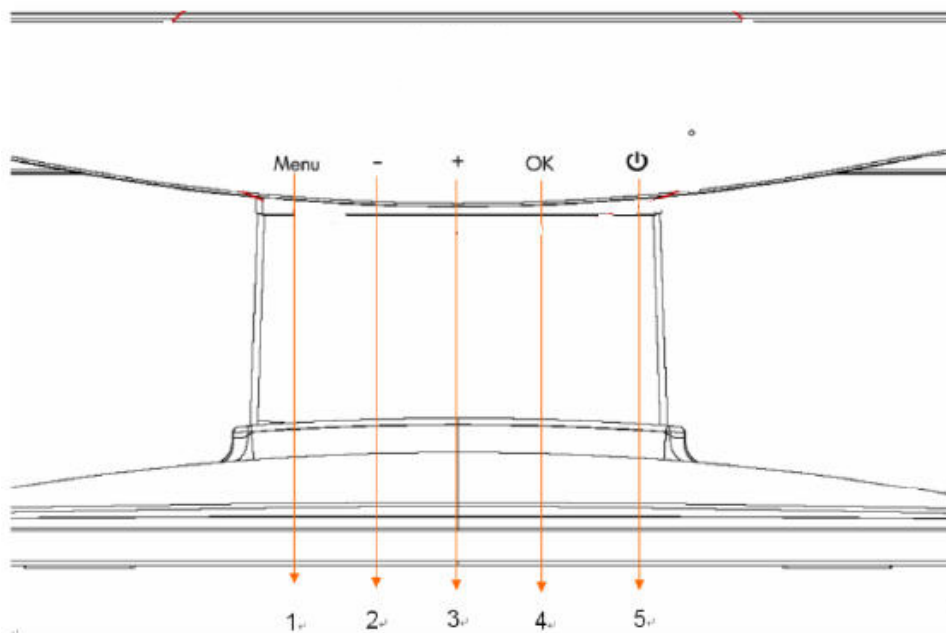

1. Menu Button (MENU)
2. Select Button -(minus)
3. Select Button +(plus)
4. OK Button (OK)
5. Power Button (POWER)

Chapter IV. Operational Instruction

4.1 Power ON/OFF Switch

Press this button to power on/off your monitor. Note: The ON/OFF switch does not disconnect your monitor from the main voltage. To completely disconnect the main voltage, please remove the power plug from the socket.

4.2 Power indicator









This indicator lights up in blue when the monitor operates normally. If the monitor runs in power-saving mode, this indicator changes to amber. When the monitor is turned off, this indicator is unlit.







4.3 Menu features





All the following features of your monitor can be accessed and adjusted by using the on screen menu (OSD) system.



1. If your monitor is not powered on, press the "Power" button to turn it on.
2. Press the "Menu" button to activate the OSD menu. The OSD main menu will be displayed.
3. To view the main menu or submenu, press the "+" on the front panel of your monitor to scroll up or the "-" to scroll down. Then press the "OK" button to select a highlighted function. When the highlight scrolls down to the bottom of the menu, it returns to top of the menu. When the highlight scrolls up to the top of the menu, it returns to bottom of the menu."
4. To adjust the selected option, press the "+" or "-" button.
5. Select "Save" and return.
If you do not want to save the setting, select "Cancel" from the submenu or "Exit" from the main menu.
6. Press the "Menu" button to exit from the OSD menu.

4.4 OSD operational instructions

Icon	Main menu option	Submenu option	Note
	Switch the video input (only applicable to some models)		When the monitor is connected to two active and valid video sources, switching between the video input sources is available. Switching the video input signal sources may take you several seconds.
	Brightness		To adjust the brightness level of the screen.
	Contrast		To adjust the contrast level of the screen.
	Image control		To adjust the image on the screen. The ambient brightness sensor can also be enabled or disabled (only applicable to some models)
		Auto-adjustment	To automatically adjust the image on the screen (only applicable to VGA input).
		Horizontal position	To adjust the horizontal position of an image (only applicable to VGA input).
		Vertical position	To adjust the vertical position of an image (only applicable to VGA input).
		Clock	To minimize the visible vertical lines or bars on the screen background. Adjusting the clock will change the horizontal image on the screen (only applicable to VGA input).
		Clock phase	To adjust the clock phase of the screen. This adjustment eliminates all horizontal noises to enable clearer and more lifelike images and characters (only applicable to VGA input)

	Color		To select the color displayed on the screen. The factory default setting is “6500 K” or “Custom color”, depending on the model of your monitor.
		Custom color	To select and adjust the color range: R – to set the level of red G – to set the level of green B – to set the level of blue
		sRGB	To set the color of the screen to comply with color standards used in the imaging industry.
	Languages		To select the language displayed on the OSD menu. The factory default setting is “English”.
	Management		To select the function of power management for your monitor.
		Volume	To adjust the volume.
		OSD control	To adjust the position of the OSD menu displayed on the screen. OSD horizontal position – to adjust the visual position of the OSD menu to the right or left of the screen. The factory default horizontal position value is 50. OSD vertical position – to adjust the visual position of the OSD menu up or down the screen. The factory default vertical position value is 50. OSD transparency – to adjust the transparency to enable transparent background information under the OSD. OSD display time – to set the OSD display time (in seconds) after the last button is pressed . The factory default setting is “30 seconds”.
		Power saver	To enable the energy-saving function Please select On off The factory default setting is On.

	Management (Continued)	Mode Display	The resolution, refresh rate and frequency information will be displayed when the OSD main menu is accessed. Please select “On” or “Off” as the factory default on-off setting, depending on the model of your monitor.
		Monitor status	The operational status of your monitor will be displayed when you power on your monitor. To select the positions where the status information is displayed: Top Middle Bottom Off The factory default setting is “Top” or “Off”, depending on the model of your monitor.
		DDC/CI support	Controlling some OSD menu functions, such as brightness, contrast and color temperature, on your computer is allowed. This feature can be set as “On” or “Off”. The factory default setting is On.
		Power indicator on the front panel	Power on/off the indicator (LED) on the power button. If the indicator is set as “Off”, it will be off all the time.
		Sleep timer	The following timer adjustment menu options are available: Set the current time – to set the current time in hours and minutes. Set the sleep time – to set the desired time when your monitor works under the sleeping mode. Set the opening time – to set the desired time when your monitor is awakened from the sleeping mode. Timer - Set “On’ or “Off” status for the Sleep Timer. The default setting is “Off”. Sleep at once – to activate the sleep mode for your monitor

		Default video input	<p>When the monitor is connected to two active and valid video sources, select one of them as the default video input. The default signal input is DVI. The change you made will be activated after your computer is restarted.</p>
	Information		<p>To select and display important information about your monitor.</p>
	Restore factory settings		<p>The factory default settings will be restored.</p>

Chapter V. Technical Information

5.1 Factory preset display mode

S1931a Model

Criteria	Resolution	Horizontal frequency	Vertical frequency
1	640X480 @60 Hz	31.469	59.94
2	720X400 @70 Hz	31.469	70.087
3	800X600 @60 Hz	37.879	60.317
4	1024X768 @60 Hz	48.363	60.004
5	1280X720 @60 Hz	45	60
6	1280X960 @ 60 Hz	60	60.00
7	1280X1024 @60 Hz	63.98	60.02
8	1366X768 @60Hz	47.71	59.79

S2031 / S2031a Models

Criteria	Resolution	Horizontal frequency	Vertical frequency
1	640X480 @60 Hz	31.469	59.94
2	720X400 @70 Hz	31.469	70.087
3	800X600 @60 Hz	37.879	60.317
4	1024X768 @60 Hz	48.363	60.004
5	1280X720 @60 Hz	44.77	59.86
6	1280X1024 @ 60 Hz	63.98	60.02
7	1440X900 @60 Hz	55.94	59.89
8	1600X900 @60Hz	60	60

S2231/S2231a/S2331 / S2331a / S2321a Models

Criteria	Resolution	Horizontal frequency	Vertical frequency
1	640X480 @60 Hz	31.469	59.94
2	720X400 @70 Hz	31.469	70.087
3	800X600 @60 Hz	37.879	60.317
4	1024X768 @60 Hz	48.363	60.004
5	1280X720 @60 Hz	44.77	59.86
6	1280X960 @ 60 Hz	60	60
7	1280X1024 @60 Hz	63.98	60.02
8	1440X900 @ 60 Hz	55.94	59.89
9	1600X1200 @ 60 Hz	75	60
10	1680X1050 @60 Hz	65.29	60
11	1920X1080 @60 Hz	67.158	60

Note: The factory preset display mode is subject to change without notice.

5.2 Product specifications

S1931a Model

Size	18.5" wide screen
Max. resolution	1366x768 @ 60 Hz
Recommended resolution	1366x768 @ 60 Hz
Horizontal frequency	24-83 kHz
Vertical frequency	50-76 Hz
Viewable size	409.8x 230.4 mm
Viewable angle	170
Pitching angle	-5° to 15°
Pixel frequency	170 MHz
OSD functions	Brightness, Contrast, Image Control, Languages, Color, Management, Information, Restore Factory Setting, Exit, OSD Control
Size (Packing)	362x 130 x 533 mm
Net weight/ Gross weight	4.08KG / 5.40KG
Power supply	100-240VAC,50/60Hz
Altitude (under operational condition)	0 to 3048 m(0 to10000 feet)
Altitude (under storing condition)	0 to 12192 m(0 to 40,000 feet)
Input signal	DVI/VGA
Contrast	1000 : 1
Brightness	250 cd/m ²
Response time	5 ms
Color displayed	16.7 M
Power	28 W
Operational environment	Temperature: 5-35°C; humidity: 20% ~ 80%
Storing environment	Temperature: -20-60°C; humidity: 10% ~ 85%

S2031 / S2031a Models

Size	20" wide screen
Max. resolution	1600 x 900 @ 60 Hz
Recommended resolution	1600 x 900 @ 60 Hz
Horizontal frequency	24-83 kHz
Vertical frequency	50-76 Hz
Viewable size	442.8x 249.08 mm
Viewable angle	170
Pitching angle	-5° to 15°
Pixel frequency	170 MHz
OSD functions	Brightness, Contrast, Image Control, Languages, Color, Management, Information, Restore Factory Setting, Exit, OSD Control
Size (Packing)	362x 130 x 533 mm
Net weight/ Gross weight	4.08KG / 5.50KG
Power supply	100-240VAC,50/60Hz
Altitude (under operational condition)	0 to 3048 m(0 to 10000 feet)
Altitude (under storing condition)	0 to 12192 m(0 to 40,000 feet)
Input signal	DVI/VGA
Contrast	1000 : 1
Brightness	250 cd/m ²
Response time	5 ms
Color displayed	16.7 M
Power	25/28 W
Operational environment	Temperature: 5-35°C; humidity: 20% ~ 80%
Storing environment	Temperature: -20-60°C; humidity: 10% ~ 85%

S2231 / S2231a Models

Size	21.5" wide screen
Max resolution	1920 X 1080 @60 Hz
Recommended resolution	1920 X 1080 @60 Hz
Horizontal frequency	24-94 kHz
Vertical frequency	50-76 Hz
Viewable size	476.64*268.11 mm
Pitching angle	-5° to 15°
Viewable angle	160
Pixel frequency	170 MHz
OSD functions	Brightness, Contrast, Image Control, Languages, Color, Management, Information, Restore Factory Setting, Exit, OSD Control
Size (Packing)	572*120*383 mm
Net weight/ Gross weight	4.12 KG / 5.57KG
Power supply	100-240VAC,50/60Hz
Altitude (under operational condition)	0 to 3048 m(0 to10000 feet)
Altitude (under storing condition)	0 to 12192 m(0 to 40,000 feet)
Input signal	DVI/VGA
Contrast	1000 : 1
Brightness	300 cd/m ²
Response time	5 ms
Color displayed	16.7 M
Power	45 W/50 W
Operational environment	Temperature: 5-35°C; Humidity: 20% ~ 80%
Storing environment	Temperature: -20-60°C; Humidity: 10% ~ 85%

S2331/ S2331a Models

Size	23" wide screen
Max. resolution	1920 X 1080 @60 Hz
Recommended resolution	1920 X 1080 @60 Hz
Horizontal frequency	24-94 kHz
Vertical frequency	50-76 Hz
Viewable size	509.18 × 286.42 mm
Pitching angle	-5° to 15°
Viewable angle	160
Pixel frequency	170 MHz
OSD functions	Brightness, Contrast, Image Control, Languages, Color, Management, Information, Restore Factory Setting, Exit, OSD Control
Size (Packing)	405 x 610 x 122 mm
Net weight/ Gross weight	4.66KG / 6.37KG
Power supply	100-240VAC,50/60Hz
Altitude (under operational condition)	0 to 3048 m(0 to10000 feet)
Altitude (under storing condition)	0 to 12192 m(0 to 40,000 feet)
Input signal	DVI/VGA
Contrast	1000 : 1
Brightness	300 cd/m ²
Response time	5 ms
Color displayed	16.7 M
Power	45 W
Operational environment	Temperature: 5-35°C; Humidity: 20% ~ 80%
Storing environment	Temperature: -20-60°C; Humidity: 10% ~ 85%

S2321a Model

Size	23" wide screen
Max. resolution	1920 X 1080 @60 Hz
Recommended resolution	1920 X 1080 @60 Hz
Horizontal frequency	24-94 kHz
Vertical frequency	50-76 Hz
Viewable size	509.18 × 286.42 mm
Pitching angle	-5° to 15°
Viewable angle	160
Pixel frequency	170 MHz
OSD functions	Brightness, Contrast, Image Control, Languages, Color, Management, Information, Restore Factory Setting, Exit, OSD Control
Size (Packing)	405 x 610 x 122 mm
Net weight/ Gross weight	4.67 KG / 6.37KG
Power supply	100-240VAC,50/60Hz
Altitude (under operational condition)	0 to 3048 m(0 to10000 feet)
Altitude (under storing condition)	0 to 12192 m(0 to 40,000 feet)
Input signal	DVI/VGA
Contrast	1000 : 1
Brightness	300 cd/m ²
Response time	5 ms
Color displayed	16.7 M
Power	55 W
Operational environment	Temperature: 5-35°C; Humidity: 20% ~ 80%
Storing environment	Temperature: -20-60°C; Humidity: 10% ~ 85%

Note: The above specifications are subject to change without notice.

5.3 Signal cable connector

PIN No.	Signal name
1	TMDS Data 2-
2	TMDS Data 2+
3	TMDS Data 2/4 Shield
4	NC
5	NC
6	DDC Clock
7	DDC Data
8	NC
9	TMDS Data 1-
10	TMDS Data 1+
11	TMDS Data 1/3 Shield
12	NC
13	NC
14	+5V Power supply
15	Testing cable
16	Hot-swap testing
17	TMDS Data 0-
18	TMDS Data 0+
19	TMDS Data 0/5 Shield
20	NC
21	NC
22	TMDS Clock Shield
23	TMDS Clock +
24	TMDS Clock -

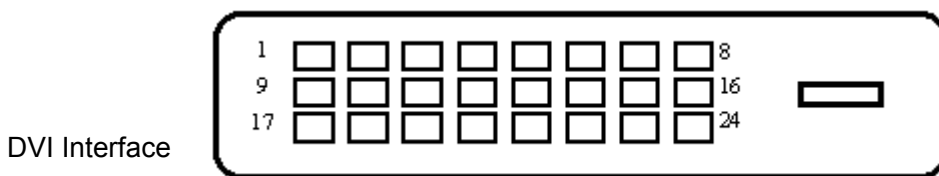

PIN	Signal
1	Red Signal
2	Green Signal
3	Blue Signal
4	Ground
5	Cable testing
6	Red Signal Ground
7	Green Signal Ground
8	Blue Signal Ground
9	5 VDC
10	Null
11	Ground
12	SDA (for DDC)
13	Horizontal synchronization
14	Vertical synchronization
15	SCL (for DDC)

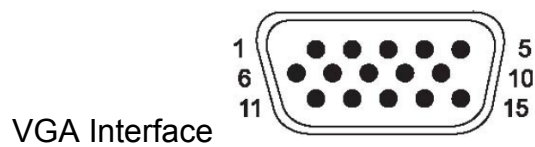

5.4 Panel testing

The ratio of valid pixels on each LCD screen reaches 99.99% or higher. However, less than 0.01% of the pixels may cause dark dots displayed on the screen.

A Safety and Maintenance Guidelines

Important Safety Information

A power cord is included with the monitor. If another cord is used, use only a power source and connection appropriate for this monitor. For information on the correct power cord set to use with the monitor, refer to the "Connecting the Power Cable" section in [Setting Up the Monitor](#).

⚠ **WARNING!** To reduce the risk of electric shock or damage to the equipment:

- Do not disable the power cord grounding feature. The grounding plug is an important safety feature.
- Plug the power cord in a grounded (earthed) outlet that is easily accessible at all times.
- Disconnect power from the product by unplugging the power cord from the electrical outlet.

For your safety, do not place anything on power cords or cables. Arrange them so that no one may accidentally step on or trip over them. Do not pull on a cord or cable. When unplugging from the electrical outlet, grasp the cord by the plug.

To reduce the risk of serious injury, read the *Safety and Comfort Guide*. It describes proper workstation, setup, posture, and health and work habits for computer users, and provides important electrical and mechanical safety information. This guide is located on the Web at <http://www.hp.com/ergo> and/or on the documentation CD, if one is included with the monitor.

⚠ **CAUTION:** For the protection of the monitor, as well as the computer, connect all power cords for the computer and its peripheral devices (such as a monitor, printer, scanner) to some form of surge protection device such as a power strip or Uninterruptible Power Supply (UPS). Not all power strips provide surge protection; the power strips must be specifically labeled as having this ability. Use a power strip whose manufacturer offers a Damage Replacement Policy so you can replace the equipment, if surge protection fails.

Use the appropriate and correctly sized furniture designed to properly support your HP LCD monitor.

⚠ **WARNING!** LCD monitors that are inappropriately situated on dressers, bookcases, shelves, desks, speakers, chests, or carts may fall over and cause personal injury.

Care should be taken to route all cords and cables connected to the LCD monitor so that they can not be pulled, grabbed, or tripped over.

Safety Precautions

Use only a power source and connection compatible with this monitor, as indicated on the label/back plate of the monitor.

Be sure the total ampere rating of the products connected to the outlet does not exceed the current rating of the electrical outlet, and the total ampere rating of the products connected to the power cord does not exceed the rating of the power cord. Look on the power label to determine the ampere rating (Amps or A) for each device.

Install your monitor near a power outlet that you can easily reach. Disconnect the monitor by grasping the plug firmly and pulling it from the outlet. Never disconnect the monitor by pulling the cord.

Do not allow anything to rest on the power cord. Do not walk on the cord.

Maintenance Guidelines

To enhance the performance and extend the life of the monitor:

Do not open the monitor cabinet or attempt to service this product yourself. Adjust only those controls that are covered in the operating instructions. If the monitor is not operating properly or has been dropped or damaged, contact an authorized HP dealer, reseller, or service provider.

Use only a power source and connection appropriate for this monitor, as indicated on the label/back plate of the monitor.

Be sure the total ampere rating of the products connected to the outlet does not exceed the current rating of the electrical outlet, and the total ampere rating of the products connected to the cord does not exceed the rating of the cord. Look on the power label to determine the ampere rating (AMPS or A) for each device.

Install the monitor near an outlet that you can easily reach. Disconnect the monitor by grasping the plug firmly and pulling it from the outlet. Never disconnect the monitor by pulling the cord.

Turn the monitor off when not in use. You can substantially increase the life expectancy of the monitor by using a screen saver program and turning off the monitor when not in use.

Slots and openings in the cabinet are provided for ventilation. These openings must not be blocked or covered. Never push objects of any kind into cabinet slots or other openings.

Do not drop the monitor or place it on an unstable surface.

Do not allow anything to rest on the power cord. Do not walk on the cord.

Keep the monitor in a well-ventilated area, away from excessive light, heat or moisture.

When removing the monitor base, you must lay the monitor face down on a soft area to prevent it from getting scratched, defaced, or broken.

Cleaning the Monitor

1. Turn off the monitor and the computer.
2. Unplug the monitor from the wall outlet.
3. Clean the monitor plastics with a clean cloth dampened with water.
4. Clean the monitor screen with an antistatic screen cleaner.

△ **CAUTION:** Do not use benzene, thinner, ammonia, or any other volatile substances to clean the monitor or the screen. These chemicals may damage the cabinet finish as well as the screen.

Shipping the Monitor

Keep the original packing box in a storage area. You may need it later if you move or ship the monitor.

B Agency Regulatory Notices

Federal Communications Commission Notice

This equipment has been tested and found to comply with the limits for a Class B digital device, pursuant to Part 15 of the FCC Rules. These limits are designed to provide reasonable protection against harmful interference in a residential installation. This equipment generates, uses, and can radiate radio frequency energy and, if not installed and used in accordance with the instructions, may cause harmful interference to radio communications. However, there is no guarantee that interference will not occur in a particular installation. If this equipment does cause harmful interference to radio or television reception, which can be determined by turning the equipment off and on, the user is encouraged to try to correct the interference by one or more of the following measures:

Reorient or relocate the receiving antenna.

Increase the separation between the equipment and the receiver.

Connect the equipment into an outlet on a circuit different from that to which the receiver is connected.

Consult the dealer or an experienced radio or television technician for help.

Modifications

The FCC requires the user to be notified that any changes or modifications made to this device that are not expressly approved by Hewlett Packard Company may void the user's authority to operate the equipment.

Cables

Connections to this device must be made with shielded cables with metallic RFI/EMI connector hoods to maintain compliance with FCC Rules and Regulations.

Declaration of Conformity for Products Marked with the FCC Logo (United States Only)

This device complies with Part 15 of the FCC Rules. Operation is subject to the following two conditions:

1. This device may not cause harmful interference.
2. This device must accept any interference received, including interference that may cause undesired operation.

For questions regarding the product, contact:

Hewlett Packard Company
P. O. Box 692000, Mail Stop 530113
Houston, Texas 77269-2000
Or, call 1-800-HP-INVENT (1-800 474-6836)

For questions regarding this FCC declaration, contact:

Hewlett Packard Company
P. O. Box 692000, Mail Stop 510101
Houston, Texas 77269-2000
Or, call (281) 514-3333

To identify this product, refer to the Part, Series, or Model number found on the product.

Canadian Notice

This Class B digital apparatus meets all requirements of the Canadian Interference-Causing Equipment Regulations.

Avis Canadien

Cet appareil numérique de la classe B respecte toutes les exigences du Règlement sur le matériel brouilleur du Canada.

European Union Regulatory Notice

This product complies with the following EU Directives:

Low Voltage Directive 2006/95/EC

EMC Directive 2004/108/EC

Ecodesign Directive 2009/125/EC where applicable

CE compliance of this product is valid only if powered with the correct CE-marked AC adapter provided by HP.

Compliance with these directives implies conformity to applicable harmonized European standards (European Norms) which are listed on the EU Declaration of Conformity issued by Hewlett-Packard for this product or product family.

This compliance is indicated by the following conformity marking placed on the product:

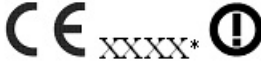
 <small>This marking is valid for non-Telecom products and EU harmonized Telecom products (e.g. Bluetooth).</small>	 <small>This marking is valid for EU non-harmonized Telecom products. *Notified body number (used only if applicable - refer to the product label)</small>
<hr/> <p>This marking is valid for non-Telecom products and EU harmonized Telecom products (e.g. Bluetooth)</p>	<hr/> <p>This marking is valid for EU non-harmonized Telecom products. *Notified body number (used only if applicable — refer to the product label).</p>

The official EU CE declaration of conformity for this device may be found at <http://www.hp.eu/certificates>.

The point of contact for regulatory matters is Hewlett-Packard GmbH, HQ-TRE, Herrenberger Strasse 140, 71034 Boeblingen, Germany.

German Ergonomics Notice

HP products which bear the "GS" approval mark, when forming part of a system comprising HP brand computers, keyboards and monitors that bear the "GS" approval mark, meet the applicable ergonomic requirements. The installation guides included with the products provide configuration information.

Japanese Notice

この装置は、クラスB情報技術装置です。この装置は、家庭環境で使用することを目的としていますが、この装置がラジオやテレビジョン受信機に近接して使用されると、受信障害を引き起こすことがあります。取扱説明書に従って正しい取り扱いをして下さい。

VCCI-B

Korean Notice

B급 기기
(가정용 방송통신기기)

이 기기는 가정용(B급)으로 전자파적합등록을 한 기기로서 주로 가정에서 사용하는 것을 목적으로 하며, 모든 지역에서 사용할 수 있습니다.

Power Cord Set Requirements

The monitor power supply is provided with Automatic Line Switching (ALS). This feature allows the monitor to operate on input voltages between 100–120V or 200–240V.

The power cord set (flexible cord or wall plug) received with the monitor meets the requirements for use in the country where you purchased the equipment.

If you need to obtain a power cord for a different country, you should purchase a power cord that is approved for use in that country.

The power cord must be rated for the product and for the voltage and current marked on the product's electrical ratings label. The voltage and current rating of the cord should be greater than the voltage and current rating marked on the product. In addition, the cross-sectional area of the wire must be a minimum of 0.75 mm² or 18 AWG, and the length of the cord must be between 6 feet (1.8 m) and 12 feet (3.6 m). If you have questions about the type of power cord to use, contact an authorized HP service provider.

A power cord should be routed so that it is not likely to be walked on or pinched by items placed upon it or against it. Particular attention should be paid to the plug, electrical outlet, and the point where the cord exits from the product.

Japanese Power Cord Requirements

For use in Japan, use only the power cord received with this product.

△ **CAUTION:** Do not use the power cord received with this product on any other products.

Product Environmental Notices

Materials Disposal

This HP product contains mercury in the fluorescent lamp in the display LCD that might require special handling at end-of-life.

Disposal of this material can be regulated because of environmental considerations. For disposal or recycling information, contact the local authorities or the Electronic Industries Alliance (EIA)
<http://www.eiae.org>.

Disposal of Waste Equipment by Users in Private Household in the European Union

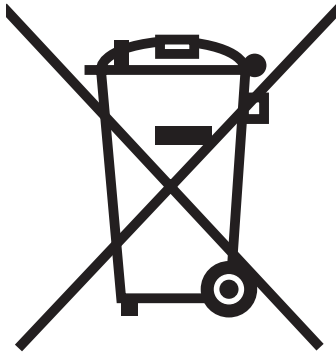

This symbol on the product or on its packaging indicates that this product must not be disposed of with your household waste. Instead, it is your responsibility to dispose of your waste equipment by handing it over to a designated collection point for the recycling or waste electrical and electronic equipment. The separate collection and recycling of your waste equipment at the time of disposal will help to conserve natural resources and ensure that it is recycled in a manner that protects human health and the environment. For more information about where you can drop off your waste equipment for recycling, please contact the local city office, the household waste disposal service or the shop where you purchased the product.

Chemical Substances

HP is committed to providing our customers with information about the chemical substances in our products as needed to comply with legal requirements such as REACH (Regulation EC No 1907/2006 of the European Parliament and Council). A chemical information report for this product can be found at <http://www.hp.com/go/reach>.

HP Recycling Program

HP encourages customers to recycle used electronic hardware, HP original print cartridges, and rechargeable batteries. For more information about recycling programs, go to <http://www.hp.com/recycle>.

Restriction of Hazardous Substances (RoHS)

A Japanese regulatory requirement, defined by specification JIS C 0950, 2005, mandates that manufacturers provide Material Content Declarations for certain categories of electronic products offered for sale after July 1, 2006. To view the JIS C 0950 material declaration for this product, visit <http://www.hp.com/go/jisc0950>.

2008年、日本における製品含有表示方法、JISC0950が公示されました。製造事業者は、2006年7月1日以降に販売される電気・電子機器の特定化学物質の含有につきまして情報提供を義務付けられました。製品の部材表示につきましては、www.hp.com/go/jisc0950を参照してください。

有毒有害物质/元素的名称及含量表

根据中国
《电子信息产品污染控制管理办法》

液晶显示器

部件名称	有毒有害物质和元素					
	铅 (Pb)	汞 (Hg)	镉 (Cd)	六价铬 (Cr(VI))	多溴联苯 (PBB)	多溴二苯醚 (PBDE)
液晶显示器显示面板	X	X	○	○	○	○
机箱/其它	X	○	○	○	○	○

CRT 显示器

部件名称	有毒有害物质和元素					
	铅 (Pb)	汞 (Hg)	镉 (Cd)	六价铬 (Cr(VI))	多溴联苯 (PBB)	多溴二苯醚 (PBDE)
阴极射线管	X	○	○	○	○	○
机箱/其它	X	○	○	○	○	○

O: 表示该有毒或有害物质在该部件所有均质材料中的含量均在 SJ/T11363-2006 标准规定的限量要求以下。

X: 表示该有毒或有害物质至少在该部件所用的某一均质材料中的含量超出 SJ/T11363-2006 标准规定的限量要求。

表中标有“X”的所有部件都符合欧盟 RoHS 法规 — “欧洲议会和欧盟理事会 2003 年 1 月 27 日关于电子电器设备中限制使用某些有害物质的 2002/95/EC 号指令”。

注: 环保使用期限的参考标识取决于产品正常工作的温度和湿度等条件。

Turkey EEE Regulation

In Conformity with the EEE Regulation

EEE Yönetmeliğine Uygundur

C Troubleshooting

Solving Common Problems

The following table lists possible problems, the possible cause of each problem, and the recommended solutions:

Problem	Solution
Power LED is not on.	Make sure the Power button is on, and the power cord is properly connected to a grounded power outlet and to the monitor.
Screen is blank.	Connect the power cord. Turn on the power. Connect the video cable properly. See "Connect your monitor to your computer" for more information. Press a key on the keyboard or move the mouse to turn off the screen-blanking utility.
Image appears blurred, indistinct, or too dark.	Press the OK button on the monitor. If this does not correct the image, press the Menu button to open the OSD menu, and adjust the brightness and contrast scales.
Image is not centered.	Press the Menu button to access the OSD menu. Select Image Control , and then select Horizontal Position or Vertical Position to adjust the position of the image.
Check Video Cable appears on screen.	Connect the monitor VGA or DVI-D signal cable to the VGA or DVI-D connector on the computer. Be sure that the computer power is off while connecting the video cable.
Input Signal Out of Range appears on screen.	Restart your computer and enter Safe Mode. Change your settings to a supported setting (see the table in " Factory Preset Display Mode" in Technical Information). Restart your computer so that the new settings take effect.
Picture is fuzzy and has ghosting, shadowing problem.	Adjust the contrast and brightness controls. Make sure that you are not using an extension cable or switch box. We recommend plugging the monitor directly into the graphic card output connector on the back of your computer. The auto adjustment feature might fix this problem (VGA input only).
Unable to set the monitor to the optimal resolution.	Make sure the graphics card supports the optimal resolution. Make sure the latest supported driver is installed for the graphics card. For HP and Compaq systems, you can download the latest graphics driver for your system from: www.hp.com/support . For other systems, refer to the Web site for your graphics card.
Screen is black or displaying at a lower resolution while displaying high-definition (HD) content.	Check if your monitor and computer support HDCP. Refer to High-Content Digital Bandwidth Protection or http://www.hp.com/support .

Problem	Solution
Unable to hear audio from built-in speakers (Select models).	<p>Do the following:</p> <p>Ensure the source signal is good by using headphones at the source.</p> <p>Press the Menu button to access the OSD menu. Select Management, and then select Volume to adjust the volume.</p> <p>Turn up the volume.</p> <p>Ensure speaker volume is not muted or too low: Click the Windows start button™, Control Panel, and Hardware and Sound. Under Audio Devices and Sound, click Adjust system volume. Under Main Volume, move the slider up.</p>
No Plug and Play.	<p>In order for the Plug and Play feature of the monitor to work, you need a computer and graphic card that are compatible with Plug and Play. Check with your computer manufacturer.</p> <p>Check the monitor's video cable, and make sure that none of the pins are bent.</p> <p>Make sure that the monitor drivers are installed. Monitor drivers are also available at: http:// www.hp.com/support</p>
Picture bounces, flickers, or wave pattern is present in the picture.	<p>Move electrical devices that may cause electrical interference as far away from the monitor as possible.</p> <p>Use the maximum refresh rate that your monitor is capable of at the resolution that you are using.</p>
Monitor is always in sleep mode (amber LED).	<p>The computer power switch should be in the On position.</p> <p>The computer graphic card should be snugly seated in its slot.</p> <p>Check that the monitor video cable is properly connected to the computer.</p> <p>Inspect the monitor video cable, and make sure that none of the pins are bent.</p> <p>Check that your computer is operational: Press the Caps Lock key and observe the Caps Lock LED found on most keyboards. The LED should either turn on or off after hitting the Caps Lock key.</p>

Getting Support from hp.com

Before you contact customer service, refer to HP Technical Support at: <http://www.hp.com/support>
Select your country/region, and then follow the links to the support page for your monitor.

Preparing to Call Technical Support

If you cannot solve a problem by using the troubleshooting tips in this section, you might have to call technical support. For technical support contact information, refer to the printed documentation included with the monitor.

Have the following information available when you call:

Monitor model number (located on label on back of monitor)

Monitor serial number (located on label on back of monitor or in the OSD display in the Information menu)

Purchase date on invoice

Conditions under which the problem occurred

Error messages received

Hardware configuration

Name and version of hardware and software you are using

Locating the Rating Label

The rating label on the monitor provides the product number and serial number. You may need these numbers when contacting HP about your monitor model.

The rating label is on the back of the monitor.