



HP Compaq L2206tm and L2206tmp LED Backlit Touch Monitors

User Guide

© 2012 Hewlett-Packard Development
Company, L.P.

Microsoft, Windows, and Windows Vista
are either trademarks or registered
trademarks of Microsoft Corporation in the
United States and/or other countries.

The only warranties for HP products and
services are set forth in the express warranty
statements accompanying such products and
services. Nothing herein should be
construed as constituting an additional
warranty. HP shall not be liable for technical
or editorial errors or omissions contained
herein.

This document contains proprietary
information that is protected by copyright.
No part of this document may be
photocopied, reproduced, or translated to
another language without the prior written
consent of Hewlett-Packard Company.

First Edition (April 2012)

Document Part Number: 685321-001

About this guide

This guide provides information on setting up the monitor, operating the touch screen, troubleshooting, and technical specifications.

 **WARNING!** Text set off in this manner indicates that failure to follow directions could result in bodily harm or loss of life.

 **CAUTION:** Text set off in this manner indicates that failure to follow directions could result in damage to equipment or loss of information.

 **NOTE:** Text set off in this manner provides important supplemental information.

Table of contents

1 Product features	1
HP LCD Touch Monitors	1
2 Setting up the monitor	3
Unfolding the monitor pedestal base	3
Rear components	4
Connecting the cables	5
Adjusting the monitor	7
Front components	9
Turning on the monitor	10
Connecting USB devices	11
Removing the monitor pedestal base	12
Mounting the monitor	13
Locating the rating labels	14
Installing a cable lock	14
3 Operating the touch screen	15
Installing the touch software	15
Microsoft Windows 7/Vista/XP (plug and play)	15
Using the touch function	17
Using an extended display (Windows 7 only)	17
Tips and troubleshooting	20
Tips	20
Touch screen troubleshooting	21
4 Finding more information	22
Appendix A Technical specifications	23
L2206tm/L2206tmp	23
Recognizing preset display resolutions	25
L2206tm/L2206tmp	25
Entering user modes	26
Energy saver feature	26
Appendix B LCD monitor quality and pixel policy	27

1 Product features

HP LCD Touch Monitors

The LCD (liquid crystal display) monitors have an active matrix, thin-film transistor (TFT) panel. The monitor models and features include:

- L2206tm model, 54.6 cm (21.5-inch) diagonal viewable area display with 1920 x 1080 resolution, plus full-screen support for lower resolutions; includes custom scaling for maximum image size while preserving original aspect ratio
- L2206tmp model, 54.6 cm (21.5-inch) diagonal viewable area display with 1920 x 1080 resolution, plus full-screen support for lower resolutions; includes custom scaling for maximum image size while preserving original aspect ratio; also includes integrated privacy filter
- LED backlight provides better clarity and consumes less energy than traditional CCFL backlights
- L2206tm has wide viewing angle to allow viewing from a sitting or standing position, or moving side-to-side
- Optical touch technology, which is Windows 7 multi-touch logo compliant and plug and play
- Tilt capability
- Pivot capability to rotate display to portrait mode
- Height adjustment capability
- Removable stand for flexible monitor panel mounting solutions
- Video signal input to support VGA analog with VGA signal cable provided
- Video signal input to support DVI digital with DVI-D signal cable provided
- Video signal input to support DisplayPort digital with DisplayPort signal cable provided
- USB 2.0 hub with one upstream port (connects to the computer) and two downstream ports (connects to USB devices)
- USB cable provided to connect the monitor's USB hub to the USB connector on the computer
- Plug and play capability, if supported by the system
- L2206tmp has integrated privacy filter to fulfill application requirements for limited off-axis viewing
- Security slot provision on rear of monitor for optional cable lock
- Cable management feature for placement of cables and cords
- On-screen display (OSD) adjustments in several languages for easy setup and screen optimization
- HP Display Assistant for adjusting monitor settings and enabling theft deterrence feature
- Integrated speakers
- Cleaning kit solution (cloth and fluid)

- Passive stylus docked in rear enclosure
- HDCP copy protection on DVI and DisplayPort inputs
- Software and documentation disc that includes monitor drivers and product documentation
- Energy saver feature to meet requirements for reduced power consumption
- Intelligent Management AssetControl
- Compliant with the following regulated specifications (for additional certifications and agency notices, refer to the *HP LCD Monitors Reference Guide* on the disc included with this monitor):
 - European Union CE Directives
 - Swedish TCO Requirements

2 Setting up the monitor

To set up the monitor, ensure that the power is turned off to the monitor, computer system, and other attached devices, and then follow the instructions below.

Unfolding the monitor pedestal base

1. Lift the monitor from its box and place it face down on a flat surface.
2. Hold down the monitor base with one hand (1) then grasp the top of the stand with the other hand and unfold the display head 90 degrees (2).

CAUTION: Do not touch the surface of the LCD panel. Pressure on the panel may cause non-uniformity of color or disorientation of the liquid crystals. If this occurs, the screen will not recover to its normal condition.

Figure 2-1 Unfolding the monitor pedestal base



NOTE: When the monitor is unfolded for the first time, the display head is locked from adjusting to a full-height position. To adjust the display head to full height, press down on the display head to unlock it, and then pull up on the display head to raise it to the full-height position. Refer to step 2 in [Adjusting the monitor on page 7](#).

Rear components

Figure 2-2 Rear components

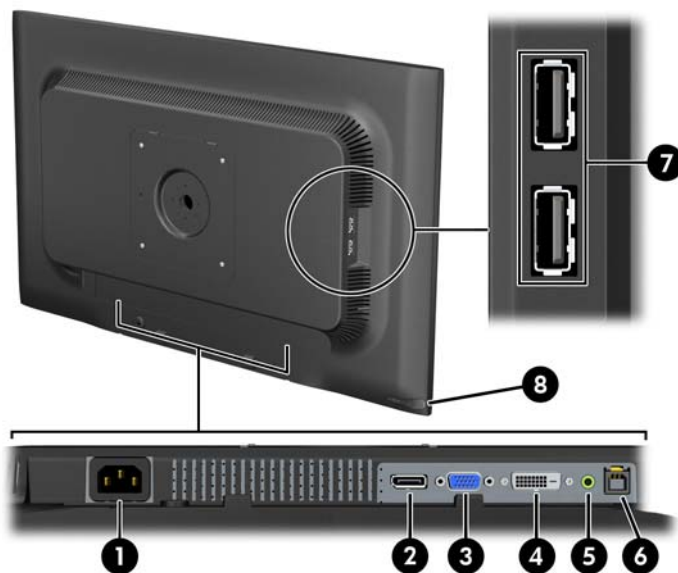

Component	Description
1 AC power connector	Connects the AC power cable to the monitor.
2 DisplayPort	Connects the DisplayPort cable to the monitor.
3 VGA connector	Connects the VGA cable to the monitor.
4 DVI-D connector	Connects the DVI-D cable to the monitor.
5 Audio connector	Connects the audio cable to the monitor.
6 USB upstream connector	Connects the USB hub cable to the monitor's USB hub connector and to a host USB port/hub.
7 USB downstream connectors (2)	Connect optional USB devices to the monitor.
8 Passive stylus	Housed in rear enclosure. When removed, it can be used as a touch pointing device. NOTE: The stylus is not required for optical touch applications. Fingers and other pointing instruments may be used.

Connecting the cables

1. Place the monitor in a convenient, well-ventilated location near the computer.
2. Remove the cable management clip from the pedestal by pulling outward on the two sides of the clip (1) and lifting the clip off the pedestal (2).

Figure 2-3 Removing the cable management clip

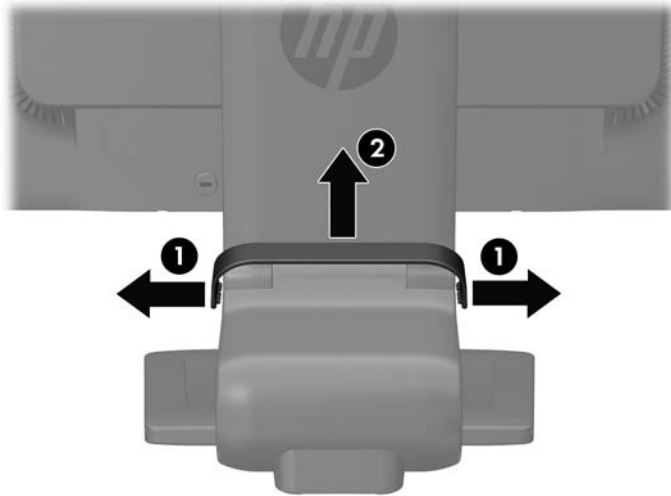

3. Connect a VGA signal cable, DVI-D signal cable, or DisplayPort signal cable.

 **NOTE:** The monitor is capable of supporting either analog or digital input. The video mode is determined by the video cable used. The monitor will automatically determine which inputs have valid video signals. The inputs can be selected by pressing the [+ / source](#) button on the front panel or through the on-screen display (OSD) feature by pressing the [Menu](#) button.

- For analog operation, use the VGA signal cable provided. Connect the VGA signal cable to the VGA connector on the rear of the monitor and to the VGA connector on the computer.
 - For DVI digital operation, use the DVI-D signal cable provided. Connect the DVI-D signal cable to the DVI connector on the rear of the monitor and to the DVI connector on the computer.
 - For DisplayPort digital operation, use the DisplayPort signal cable provided. Connect the DisplayPort signal cable to the DisplayPort connector on the rear of the monitor and to the DisplayPort connector on the computer.
4. Connect one end of the provided audio cable to the audio connector on the computer, and connect the other end to the audio-in connector on the monitor.
 5. Connect one end of the provided USB cable to the USB upstream connector on the rear of the monitor, and connect the other end to a USB connector on the computer.

6. Connect one end of the power cord to the AC power connector on the back of the monitor, and connect the other end to an electrical wall outlet.

Figure 2-4 Connecting the cables

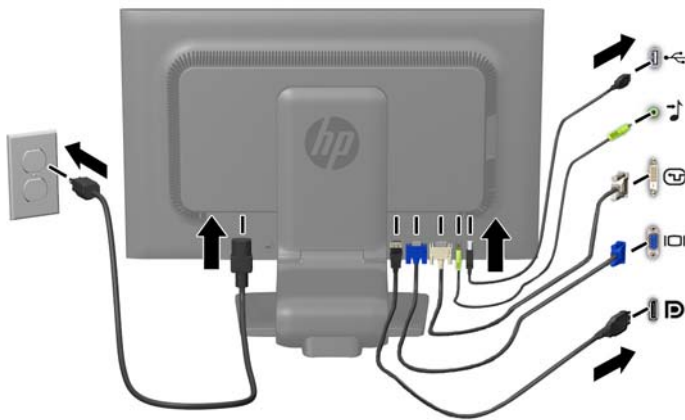

⚠ WARNING! To reduce the risk of electric shock or damage to the equipment:

Do not disable the power cord grounding plug. The grounding plug is an important safety feature. Plug the power cord into a grounded (earthed) electrical outlet that is easily accessible at all times.

Disconnect power from the equipment by unplugging the power cord from the electrical outlet.

For your safety, do not place anything on power cords or cables. Arrange them so that no one may accidentally step on or trip over them. Do not pull on a cord or cable. When unplugging from the electrical outlet, grasp the cord by the plug.

7. Secure the cables in place with the cable management clip. Press the clip straight down on the curved neck of the pedestal ensuring that the tabs on the sides of the clip snap into the slots on the pedestal.

Figure 2-5 Installing the cable management clip

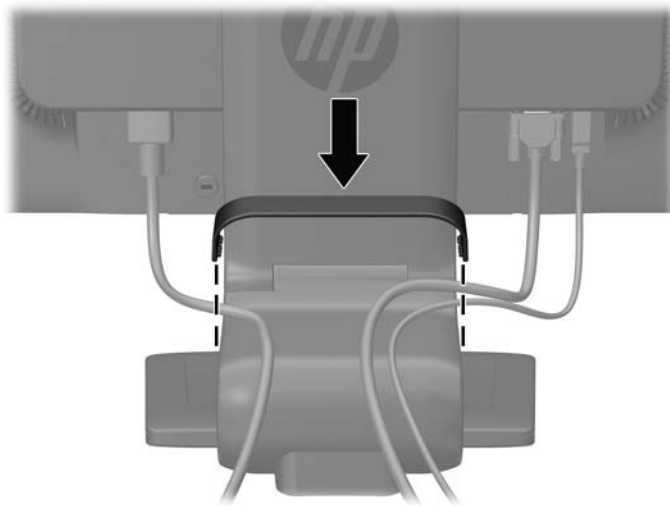

Adjusting the monitor

 **NOTE:** Your monitor model may look different than the model in the following illustrations.

1. Tilt the monitor's panel forward or backward to set it to a comfortable eye level.

Figure 2-6 Tilting the monitor



2. Adjust the monitor's height to a comfortable position for your individual workstation. The monitor's top bezel edge should not exceed a height that is parallel to your eye height. A monitor that is positioned low and reclined may be more comfortable for users with corrective lenses. The monitor should be repositioned as you adjust your working posture throughout the work day.

 **NOTE:** When the monitor is unfolded for the first time, the display head is locked from adjusting to a full-height position. To adjust the display head to full height, press down on the display head to unlock it, and then pull up on the display head to raise it to the full-height position.

Figure 2-7 Adjusting the height



3. Pivot the monitor from landscape to portrait orientation viewing to adapt to your application.
 - a. Adjust the monitor to full-height position and tilt the monitor back to full-tilt position (1).
 - b. Pivot the monitor clockwise 90° from landscape to portrait orientation (2).

CAUTION: If the monitor is not in full-height and full-tilt position when pivoting, the bottom right corner of the monitor panel will come in contact with the base and potentially cause damage to the monitor.

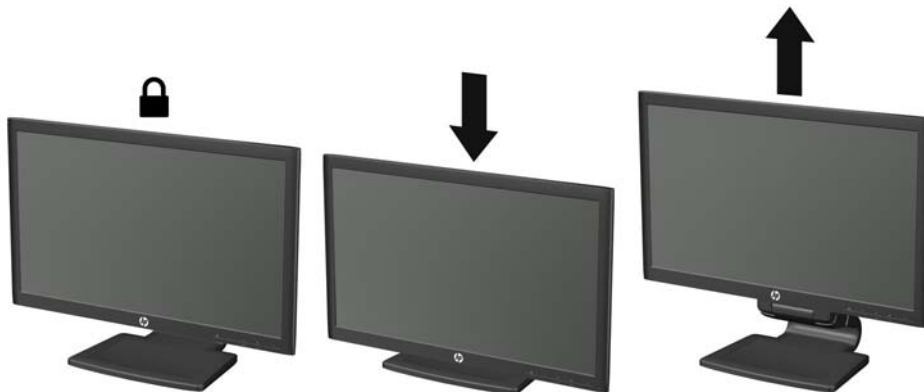
Figure 2-8 Pivoting the monitor

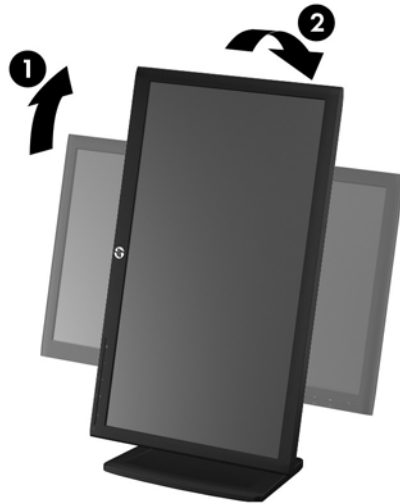

NOTE: To view information on the screen in portrait mode, you can install the HP Display Assistant software included on the software and documentation disc. The position of the OSD menu can also be rotated to portrait mode. To rotate the OSD menu, access the OSD menu by pressing the **Menu** button on the front panel, select **OSD Control** from the menu, and then select **Rotate OSD**.

Front components

Figure 2-9 Front components

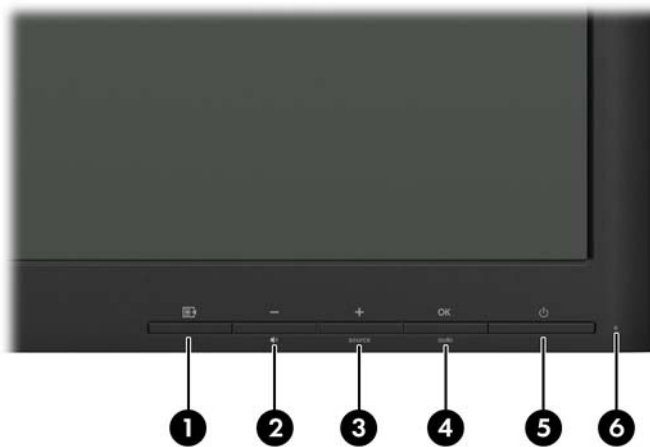









Table 2-1 Front components

Component	Description
1 	Menu button Opens, selects from, or exits the OSD menu.
2 	Minus/volume button If the OSD menu is on, press to navigate backward through the OSD menu and decrease adjustment levels. If the OSD menu is inactive, press to activate the volume adjustment menu.
3 	Plus/source button If the OSD menu is on, press to navigate forward through the OSD menu and increase adjustment levels. If the OSD menu is inactive, press to activate the source button that chooses the video signal input (DisplayPort, DVI, or VGA).
4 	OK/auto button If the OSD menu is on, press to select the highlighted menu item. If the OSD menu is inactive, press to activate the auto adjustment feature to optimize the screen image.
5 	Power button Turns the monitor on or off.
6	Power LED Blue = Fully powered. Amber = Sleep mode. Flashing Amber = Sleep timer mode.

 **NOTE:** To view an OSD menu simulator, visit the HP Customer Self Repair Services Media Library at <http://www.hp.com/go/sml>.

Turning on the monitor

1. Press the power button on the computer to turn it on.
2. Press the power button on the front of the monitor to turn it on.

 **CAUTION:** Burn-in image damage may occur on monitors that display the same static image on-screen for 12 or more consecutive hours of non-use. To avoid burn-in image damage on the monitor screen, you should always activate a screen saver application or turn off the monitor when it is not in use for a prolonged period of time. Image retention is a condition that may occur on all LCD screens. Monitors with a “burned-in image” are not covered under the HP warranty.

 **NOTE:** If pressing the power button has no effect, the Power Button Lockout feature may be enabled. To disable this feature, press and hold the monitor power button for 10 seconds.

 **NOTE:** You can disable the power LED in the OSD menu. Press the [Menu](#) button on the front of the monitor, then select **Management > Bezel Power LED > Off**.

When the monitor is powered on, a status message is displayed for five seconds. The message shows which input (DisplayPort, DVI, or VGA) is the current active signal, the status of the auto-switch source setting (On or Off; factory default is On), the default source signal (factory default is DisplayPort), the current preset display resolution, and the recommended preset display resolution.

The monitor automatically scans the signal inputs for an active input and uses that input for the display. If two or more inputs are active, the monitor will display the default input source. If the default source is not one of the active inputs, then the monitor will display the highest ranking priority input in the following order: DisplayPort, DVI, then VGA. You can change the default source in the OSD by pressing the front panel [Menu](#) button and selecting **Source Control > Default Source**.

Connecting USB devices

USB connectors are used to connect devices such as a digital camera, USB keyboard, or USB mouse. Two USB connectors are located on the side panel of the monitor.

 **NOTE:** You must connect the USB hub cable from the monitor to the computer to enable the USB 2.0 ports on the monitor. Refer to Step 4 in [Connecting the cables on page 5](#).

Figure 2-10 Connecting USB devices



Removing the monitor pedestal base

You can remove the monitor panel from the pedestal base to install the panel on a wall, swing arm, or other mounting fixture.

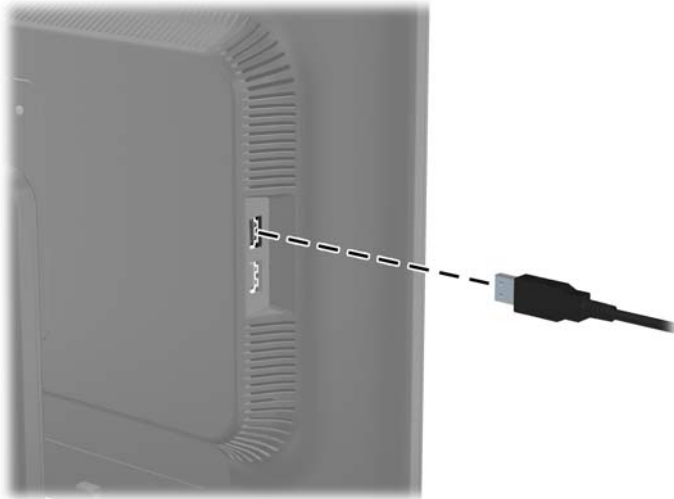
⚠ CAUTION: Before beginning to disassemble the monitor, be sure the monitor is turned off and the power and signal cables are both disconnected. Also disconnect all USB cables connected to the monitor.

1. Disconnect and remove the signal, power, and USB cables from the monitor.
2. Lay the monitor face down on a flat surface covered by a clean, dry cloth.
3. Pivot the base 45 degrees clockwise and remove the screw from the back of the monitor, and then pivot the base 45 degrees counter-clockwise and remove the other screw from the back of the monitor.

Figure 2-11 Removing the pedestal base screws



4. Rotate the base of the monitor up (1) and pull it back (2) to unhinge the tabs on the monitor stand from the slots in the monitor.

Figure 2-12 Removing the pedestal base

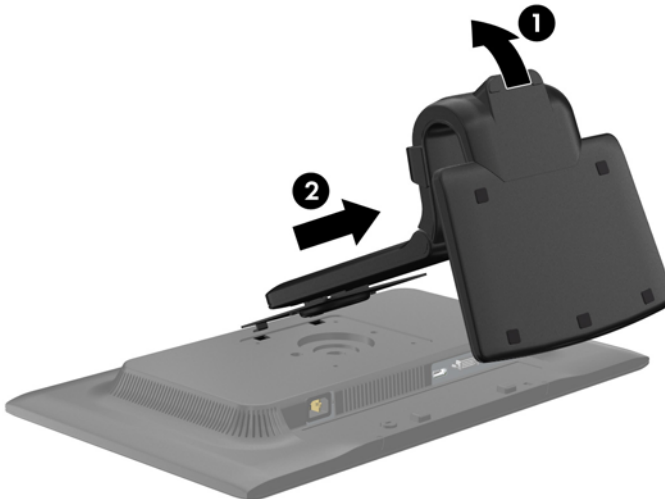

Mounting the monitor

The monitor panel can be attached to a wall, swing arm, or other mounting fixture.

 **NOTE:** This apparatus is intended to be supported by a UL or CSA listed wall mount bracket.

1. Remove the monitor panel from the pedestal base. Refer to [Removing the monitor pedestal base on page 12](#).

 **CAUTION:** This monitor supports the VESA industry standard 100 mm mounting holes. To attach a third-party mounting solution to the monitor, four 4 mm, 0.7 pitch, and 10 mm long screws are required. Longer screws must not be used because they may damage the monitor. It is important to verify that the manufacturer's mounting solution is compliant with the VESA standard and is rated to support the weight of the monitor display panel. For best performance, it is important to use the power and video cables provided with the monitor.

2. To attach the monitor to a swing arm, insert four 10 mm screws through the holes on the swing arm plate and into the mounting holes on the monitor.

Figure 2-13 Mounting the monitor

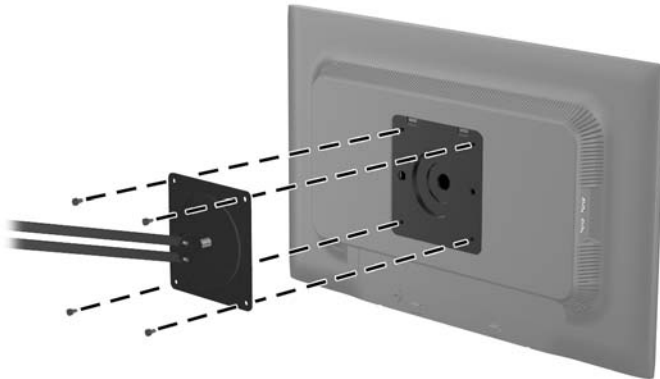

To attach the monitor to other mounting fixtures, follow the instructions included with the mounting fixture to ensure that the monitor is safely attached.

3. Reconnect the cables to the monitor panel.

Locating the rating labels

The rating labels on the monitor provide the spare part number, product number, and serial number. You may need these numbers when contacting HP about the monitor model. The rating labels are located on the rear panel of the monitor display head.

Figure 2-14 Locating the rating labels



Installing a cable lock

You can secure the monitor to a fixed object with an optional cable lock available from HP.

Figure 2-15 Installing a cable lock

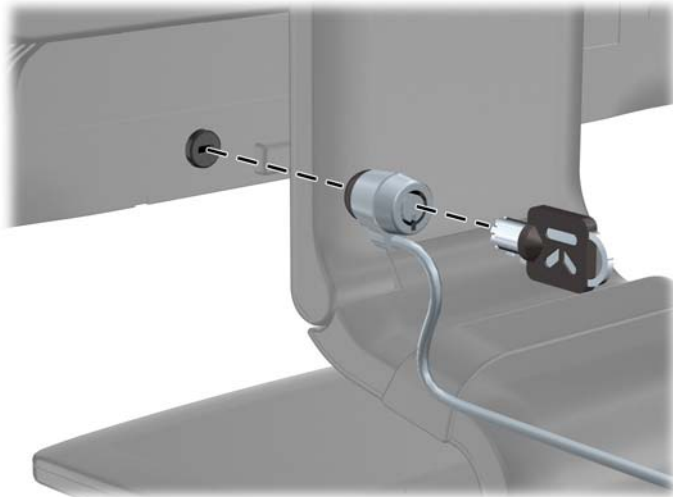

3 Operating the touch screen

Installing the touch software

Microsoft Windows 7/Vista/XP (plug and play)

 **NOTE:** Refer to [Connecting the cables on page 5](#) for instructions on connecting the USB cable.

When you connect the USB cable between the monitor and a computer running Windows 7, Windows Vista, or Windows XP, the touch driver software will automatically install. The driver software may take a minute to install, and for Windows 7 and Windows Vista a message will display on the monitor screen indicating that the driver software has been installed successfully. After the touch driver software is installed, you can select, launch, and drag objects using the touch screen. To make a selection, touch the screen.

 **NOTE:** For Windows XP, the touch driver loads as an input device, so there will be no message verifying the driver installation.

 **NOTE:** Multi-touch gestures are supported in Windows 7 Home Premium, Professional, Enterprise, and Ultimate operating system editions only. Multi-touch is not supported in Windows 7 Home Basic or Starter editions, Windows Vista, or Windows XP.

 **NOTE:** If touch control does not begin to work within 20 seconds, you should verify that the touch driver is installed.

To verify that the touch driver is installed:

- Windows 7—Select **Start > Control Panel > System and Security > System**, and ensure that **Pen and Touch: Touch Input Available with 2 Touch Points** is listed in the **System** section.
- Windows Vista—Select **Start > Control Panel > Mobile PC > Pen and Input Devices**. If the **Touch** tab appears, touch input is available.

- Windows XP—Select **Start > Control Panel > System**, and then select the **Hardware** tab. Select the **Device Manager** button. If the driver is installed correctly, two **HID-compliant device** entries and one **USB Human Interface Device** entry will appear under the **Human Interface Devices** category. Also, under the **Mice and other pointing devices** category, one **HID-compliant mouse** entry will appear.

Figure 3-1 Verify Windows XP touch driver installation

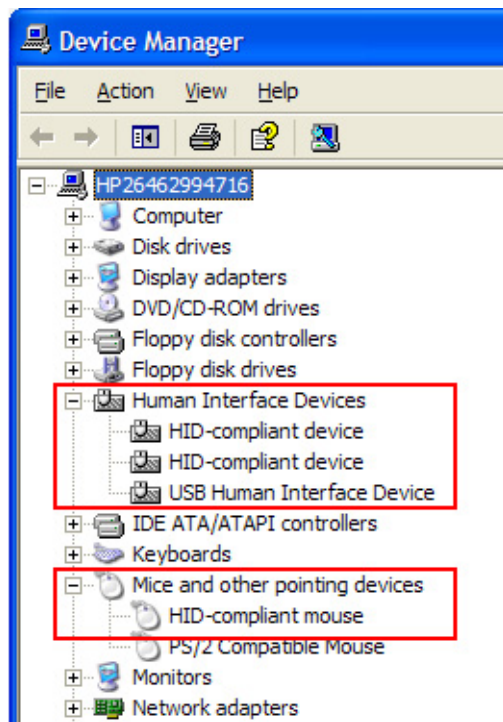

Using the touch function

 **NOTE:** Before using the touch function, make sure the USB cable is connected and the Windows operating system is started.

 **NOTE:** When the touch function is active, make sure there are no foreign objects in the areas encircled in the figure below.

Figure 3-2 Make sure there are no foreign objects in the encircled areas



The touch function may replace the mouse after you start the Windows operating system. Use your finger or the provided stylus for touch applications. Gesture compatibility is listed below:

Table 3-1 Gesture compatibility

Finger operation	Windows 7	Windows Vista	Windows XP Tablet	Windows XP
Drag	✓	✓	✓	✓
Click	✓	✓	✓	✓
Double-click	✓	✓	✓	✓
Single-touch digitizer	✓	✓	✓	
Multi-touch gestures	✓			

 **NOTE:** Refer to <http://msdn.microsoft.com/en-us/library/dd371585> for topics on various gestures that are supported in Windows 7.

 **NOTE:** Windows multi-touch gestures are not supported in Windows 7 Home Basic or Starter editions.

Using an extended display (Windows 7 only)

Windows 7 Home Premium, Professional, Enterprise, and Ultimate editions support extended display touch screen functions for two monitors connected to one system.

 **NOTE:** Windows 7 Home Basic and Starter editions, Windows Vista, and Windows XP do not support extended display touch functionality. They support single-touch functions on the primary monitor only, not the secondary monitor (extended or cloned desktop).

1. Make sure a USB cable is connected from the computer to each monitor.
2. Select **Start > Control Panel**.

3. Select the **View by** drop-down list, and then select either **Large icons** or **Small icons**.
4. Select the **Tablet PC Settings** control panel.

 **NOTE:** The Tablet PC Settings control panel will only appear after Microsoft Windows 7 recognizes a connected touch monitor.

5. On the **Display** tab in the Tablet PC Settings, select the name of the first monitor you want to calibrate from the drop-down menu.

Figure 3-3 Select the display

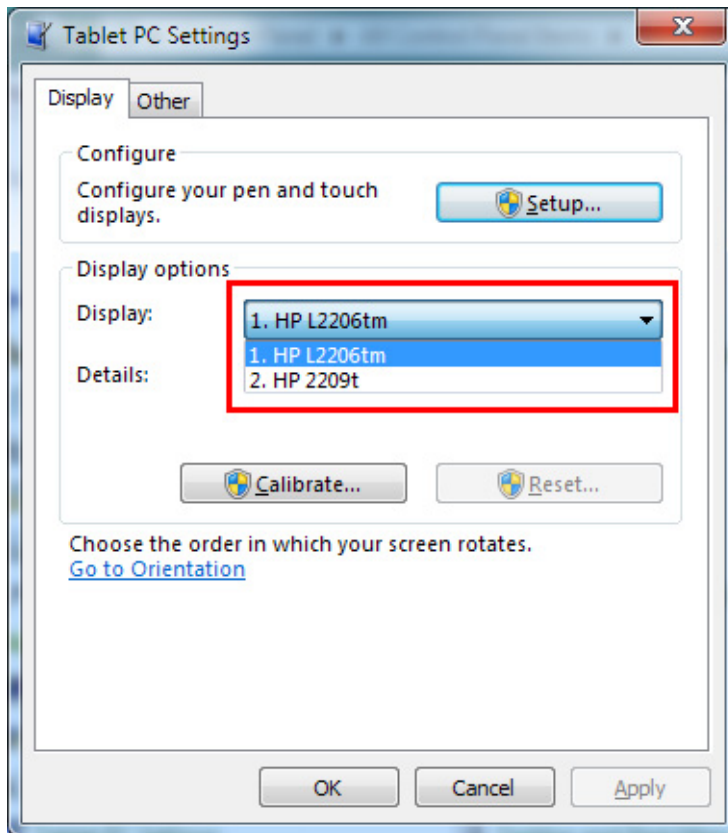

6. Select the **Calibrate...** button.

Figure 3-4 Calibrate the display

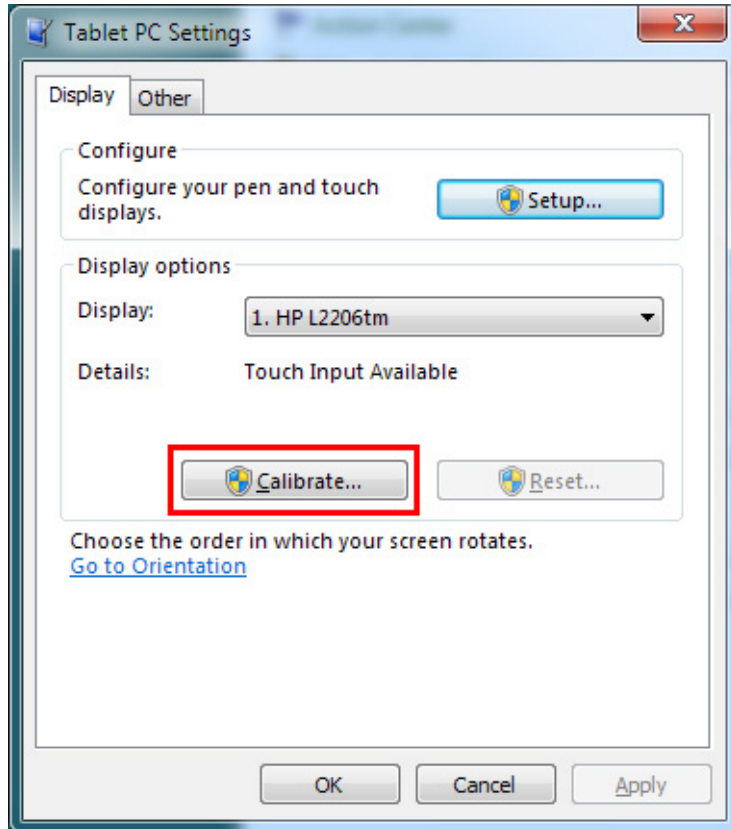

7. Repeat steps 5 and 6 for the second monitor.

 **NOTE:** If you have two monitors that are the same model, be sure to note which model is calibrated first because both will appear with identical names.

Tips and troubleshooting

Tips

-  **WARNING!** Keep the display away from any heat sources, such as electric radiators, natural gas pipes, or direct sunlight. Also keep the display away from excessive dust, mechanical vibration, or shock.

For safety, remove the power plug prior to cleaning.

- To maintain a brand new appearance of the display, clean with a soft cloth regularly. Remove stubborn stains with a soft cleaner.

-  **CAUTION:** Do not use strong cleaners such as a diluting agent, benzene, or a corrosive cleaner, as they may damage the display.

- Never disassemble or repair the product yourself. If your problem cannot be solved according to the troubleshooting guidelines, please contact your local dealer.
- Retain the original packaging materials. They will be convenient if you need to transport your display again.

-  **NOTE:** For best protection, pack the display in the original manner of package from the factory.

- The touch function may need about seven seconds to resume if the USB cable is re-plugged or the computer resumes from Sleep mode.

Touch screen troubleshooting

 **NOTE:** For general troubleshooting information, refer to the *HP LCD Monitors Reference Guide* included on the disc with your monitor.

Table 3-2 Touch screen troubleshooting

Problem	Solution
Computer does not recover from Sleep mode when the touch screen is touched.	Sleep mode recovery is not supported by the touch screen. Use the keyboard or mouse to recover from Sleep mode.
The USB cable is quickly removed from the monitor and reinserted, and the touch function is lost.	Windows takes a minimum amount of time to adjust system parameters when a USB device is either removed or connected. Try removing the USB cable again, wait for at least five seconds, and then plug it in again.
Multi-touch gestures do not function on Windows 7 Home Basic or Starter editions, Windows Vista, or Windows XP.	Only Windows 7 Home Premium, Professional, Enterprise, and Ultimate editions support multi-touch gestures.
The Start , Close , and other icons are too small to touch with a finger.	Windows 7 provides a large icon feature that supports touch screen functions. This feature can be accessed in the Control Panel. A stylus may also be used.
Touch operation does not function properly on lower-resolution video modes that are not displayed in fullscreen.	Although the monitor supports a fill-to-aspect ratio function, the touch controller does not know how to respond to less-than-fullscreen images. Either change the resolution to 1920 x 1080, or access the OSD menu and select Image Control to enable Fill-to-Screen (default setting).
A single touch is recognized as two touches. If using a paint tool, a single finger creates two lines.	The touch controller has a limitation on the size of the "touch" area. A fingertip touch usually works better than a flat forefinger or thumb touch.
When the monitor used is in a dual-screen configuration, the touch function on the second display does not work.	The USB connection is only capable of operating a single-touch screen monitor. If the second monitor is a touch monitor, you must connect a second USB cable. NOTE: Windows 7 Home Basic and Starter editions, Windows Vista, and Windows XP do not support extended display touch functionality. They support single-touch functions on the primary monitor only, not the secondary monitor (extended or cloned desktop).

4 Finding more information

Refer to the *HP LCD Monitors Reference Guide* included on the disc with your monitor for additional information on:

- Optimizing monitor performance
- Safety and maintenance guidelines
- Installing software from the disc
- Using the OSD menu
- Downloading software from the Web
- Agency and regulatory notices
- Troubleshooting and recommended solutions to common problems

For additional information on using and adjusting your monitor, go to <http://www.hp.com/support>. Select your country or region, select **Product Support & Troubleshooting**, and then enter your monitor model name and number.

A Technical specifications

 **NOTE:** All specifications represent the typical specifications provided by HP's component manufacturers; actual performance may vary either higher or lower.

L2206tm/L2206tmp

Table A-1 L2206tm/L2206tmp specifications

Display	54.61 cm widescreen	21.5 inches widescreen
Type	TFT LCD	
Viewable image size	54.61 cm diagonal	21.5 inch diagonal
Tilt	-5 to 30°	
Brightness (typical)	230 cd/m ²	
Maximum weight (unpacked):		
Assembled with base	7.0 kg	15.4 lbs
Display only	4.6 kg	10.11 lbs
Dimensions (including base):		
Height (highest position)	44.5 cm	17.52 inches
Height (lowest position)	34.5 cm	13.58 inches
Depth	22.8 cm	8.98 inches
Width	51.8 cm	20.39 inches
Maximum graphic resolution	1920 x 1080 (60 Hz) analog input 1920 x 1080 (60 Hz) digital input	
Optimum graphic resolution	1920 x 1080 (60 Hz) analog input 1920 x 1080 (60 Hz) digital input	
Text mode	720 x 400	
Dot pitch	0.248 (H) x 0.248 (W) mm	
Pixels per inch	102 PPI	
Horizontal frequency	24 kHz to 94 kHz	
Vertical refresh rate	50 Hz to 76 Hz	

Table A-1 L2206tm/L2206tmp specifications (continued)

Environmental requirements:		
Temperature (operating)	5° C to 35° C	41° F to 95° F
Temperature (non-operating)	-20° C to 60° C	-4° F to 140° F
Humidity (operating)	20% to 80%	
Humidity (non-operating)	5% to 95%	
Altitude (operating)	0 m to 5,000 m	0 ft to 16,400 ft
Altitude (non-operating)	0 m to 12,192 m	0 ft to 40,000 ft

Power source	100 – 240 VAC 50/60 Hz	
--------------	------------------------	--

Measured power consumption:		
Full power	39 watts	
Typical settings	25 watts	
Sleep	0.5 watts	
Switch off	0.5 watts	

Input terminal	One VGA connector with cable included; one DVI connector with cable included; one DisplayPort connector with cable included	
----------------	---	--

Recognizing preset display resolutions

The display resolutions listed below are the most commonly used modes and are set as factory defaults. This monitor automatically recognizes these preset modes and they will appear properly sized and centered on the screen.

L2206tm/L2206tmp

Table A-2 Factory preset modes

Preset	Pixel format	Horz freq (kHz)	Vert freq (Hz)
1	640 × 480	31.469	59.940
2	720 × 400	31.469	70.087
3	800 × 600	37.879	60.317
4	1024 × 768	48.363	60.004
5	1280 × 720	45.00	60.00
6	1280 × 1024	63.981	60.02
7	1440 × 900	55.935	59.887
8	1600 × 900	60.00	60.00
9	1680 × 1050	65.29	59.954
10	1920 × 1080	67.50	60.00

Table A-3 High Definition video formats

Preset	Timing name	Pixel format	Horz freq (kHz)	Vert freq (Hz)
1	480p	720 × 480	31.469	60
2	576p	720 × 576	31.25	50
3	720p50	1280 × 720	37.5	50
4	720p60	1280 × 720	45	60
5	1080p50	1920 × 1080	56.25	50
6	1080p60	1920 × 1080	67.5	60

Entering user modes

The video controller signal may occasionally call for a mode that is not preset if:

- You are not using a standard graphics adapter.
- You are not using a preset mode.

If this occurs, you may need to readjust the parameters of the monitor screen by using the on-screen display. Your changes can be made to any or all of these modes and saved in memory. The monitor automatically stores the new setting, then recognizes the new mode just as it does a preset mode. In addition to the factory preset modes, there are at least 10 user modes that can be entered and stored.

Energy saver feature

The monitors support a reduced power state. The reduced power state will be entered into if the monitor detects the absence of either the horizontal sync signal and/or the vertical sync signal. Upon detecting the absence of these signals, the monitor screen is blanked, the backlight is turned off, and the power light is turned amber. When the monitor is in the reduced power state, the monitor will utilize 0.5 watts of power. There is a brief warm-up period before the monitor will return to its normal operating mode.

Refer to the computer manual for instructions on setting energy saver features (sometimes called power management features).



NOTE: The above power saver feature only works when connected to computers that have energy saver features.

By selecting the settings in the monitor's Energy Saver utility, you can also program the monitor to enter into the reduced power state at a predetermined time. When the monitor's Energy Saver utility causes the monitor to enter the reduced power state, the power light blinks amber.

B LCD monitor quality and pixel policy

The TFT monitor uses high-precision technology that is manufactured according to HP standards to guarantee trouble-free performance. Nevertheless, the display may have cosmetic imperfections that appear as small bright or dark spots. This is common to all LCD displays used in products supplied by all vendors and is not specific to the HP LCD. These imperfections are caused by one or more defective pixels or sub-pixels.

- A pixel consists of one red, one green, and one blue sub-pixel.
- A defective whole pixel is always turned on (a bright spot on a dark background), or it is always off (a dark spot on a bright background). The first is the more visible of the two.
- A defective sub-pixel (dot defect) is less visible than a defective whole pixel and is small and only visible on a specific background.

To locate defective pixels, the monitor should be viewed under normal operating conditions, in normal operating mode, at a supported resolution and refresh rate, and from a distance of approximately 50 cm (20 in).

HP expects that, over time, the industry will continue to improve its ability to produce LCDs with fewer cosmetic imperfections and HP will adjust guidelines as improvements are made.