



HP Compaq LA1956x, LA2006x,  
LA2206x, and LA2306x LED Backlit LCD  
Monitors

User Guide

© 2010-2012, Hewlett-Packard  
Development Company, L.P.

Microsoft, Windows, and Windows Vista  
are either trademarks or registered  
trademarks of Microsoft Corporation in the  
United States and/or other countries.

The only warranties for HP products and  
services are set forth in the express warranty  
statements accompanying such products and  
services. Nothing herein should be  
construed as constituting an additional  
warranty. HP shall not be liable for technical  
or editorial errors or omissions contained  
herein.

This document contains proprietary  
information that is protected by copyright.  
No part of this document may be  
photocopied, reproduced, or translated to  
another language without the prior written  
consent of Hewlett-Packard Company.

Fourth Edition (June 2012)

Document Part Number: 630579-004

## About This Guide

This guide provides information on setting up the monitor, installing drivers, using the on-screen display menu, troubleshooting and technical specifications.

---

 **WARNING!** Text set off in this manner indicates that failure to follow directions could result in bodily harm or loss of life.

 **CAUTION:** Text set off in this manner indicates that failure to follow directions could result in damage to equipment or loss of information.

 **NOTE:** Text set off in this manner provides important supplemental information.

---



---

# Table of contents

<b>1 Product Features</b>	<b>1</b>
HP LCD Monitors	1
<b>2 Setting Up the Monitor</b>	<b>3</b>
Unfolding the Monitor Pedestal Base	3
Attaching the Stand to the HP LA1956x Monitor	4
Rear Components	5
Connecting the Cables	6
Front Panel Controls	10
Adjusting the Monitor	11
Turning on the Monitor	13
Connecting USB Devices	14
Removing the Monitor Pedestal Base	15
Removing the Stand from the HP LA1956x Monitor	16
Mounting the Monitor	17
Locating the Rating Labels	18
Installing a Cable Lock	18
<b>3 Finding More Information</b>	<b>19</b>
Reference Guides	19
Product Support	19
<b>Appendix A Technical Specifications</b>	<b>20</b>
LA1956x Model	20
LA2006x Model	21
LA2206x Model	22
LA2306x Model	23
Recognizing Preset Display Resolutions	25
LA1956x Model	25
LA2006x Model	25
LA2206x Model	26
LA2306x Model	26
Entering User Modes	27
Energy Saver Feature	27



---

# 1 Product Features

## HP LCD Monitors

The LCD (liquid crystal display) monitors have an active matrix, thin-film transistor (TFT) panel. The monitor models and features include:

- LA1956x model, 48.3 cm (19-inch) diagonal viewable area display with 1280 x 1024 resolution, plus full-screen support for lower resolutions: includes custom scaling for maximum image size
- LA2006x model, 50.8 cm (20-inch) diagonal viewable area display with 1600 x 900 resolution, plus full-screen support for lower resolutions; includes custom scaling for maximum image size while preserving original aspect ratio
- LA2206x model, 54.6 cm (21.5-inch) diagonal viewable area display with 1920 x 1080 resolution, plus full-screen support for lower resolutions; includes custom scaling for maximum image size while preserving original aspect ratio
- LA2306x model, 58.4 cm (23-inch) diagonal viewable area display with 1920 x 1080 resolution, plus full-screen support for lower resolutions; includes custom scaling for maximum image size while preserving original aspect ratio
- Non-glare panel with an LED backlight
- Wide viewing angle to allow viewing from a sitting or standing position, or moving side-to-side
- Tilt capability
- Pivot capability to rotate display to portrait mode
- Swivel and height adjustment capabilities
- Removable stand for flexible monitor panel mounting solutions
- Video signal input to support VGA analog (cables are provided with select models)
- Video signal input to support DVI digital (cables are provided with select models)
- Video signal input to support DisplayPort digital (cables are provided with select models)
- USB 2.0 hub with one upstream port (connects to the computer) and two downstream ports (connects to USB devices)
- USB cable provided to connect the monitor's USB hub to the USB connector on the computer
- Supports an optional HP speaker bar
- Plug and play capability if supported by the system
- Privacy filter slots to insert filters (purchased separately) to block side screen viewing
- Security slot provision on rear of monitor for optional cable lock
- Cable management feature for placement of cables and cords

- On-Screen Display (OSD) adjustments in several languages for easy setup and screen optimization
- HP Display Assistant for adjusting monitor settings and enabling theft deterrence features
- HDCP copy protection on DVI and DisplayPort inputs
- Software and documentation CD that includes monitor drivers and product documentation
- Energy saver feature to meet requirements for reduced power consumption
- Energy Star® qualified
- Intelligent Management AssetControl
- Compliant with the following regulated specifications (for additional certifications and agency notices, refer to the *HP LCD Monitors Reference Guide* on the CD included with this monitor):
  - European Union CE Directives
  - Swedish TCO Requirements



---

## 2 Setting Up the Monitor

To set up the monitor, ensure that the power is turned off to the monitor, computer system, and other attached devices, then follow the instructions below.

### Unfolding the Monitor Pedestal Base

---

 **NOTE:** The following steps apply to the HP LA2006x, LA2206x, and LA2306x models.

---

1. Lift the monitor from its box and place it face down on a flat surface.
2. Hold down the monitor base with one hand (1) then grasp the top of the stand with the other hand and unfold the display head 90 degrees (2).

 **CAUTION:** Do not touch the surface of the LCD panel. Pressure on the panel may cause non-uniformity of color or disorientation of the liquid crystals. If this occurs the screen will not recover to its normal condition.

---

**Figure 2-1** Unfolding the Monitor Pedestal Base



---

 **NOTE:** When the monitor is unfolded for the first time, the display head is locked from adjusting to a full-height position. To adjust the display head to full height, press down on the display head to unlock it then pull up on the display head to raise it to the full-height position. Refer to step 3 in [Adjusting the Monitor on page 11](#).

---

# Attaching the Stand to the HP LA1956x Monitor

 **NOTE:** The following steps apply only to the HP LA1956x model.

1. Lift the monitor from its box and place it face down on a flat surface.
2. Attach the base to the stand.



3. Tighten the screw on the bottom of the stand by hand.



# Rear Components

Figure 2-2 Rear Components



Component	Function
1 AC Power Connector	Connects the AC power cord to the monitor.
2 DisplayPort	Connects the DisplayPort cable to the monitor.
3 DVI-D	Connects the DVI-D cable to the monitor.
4 VGA	Connects the VGA cable to the monitor.
5 USB Upstream Connector	Connects the USB hub cable to the monitor's USB hub connector and to a host USB port/hub.
6 USB Downstream Connectors (2)	Connects optional USB devices to the monitor.

## Connecting the Cables

1. Place the monitor in a convenient, well-ventilated location near the computer.
2. Remove the cable management clip from the pedestal by pulling outward on the two sides of the clip (1) then lifting the clip off the pedestal (2).

**Figure 2-3** Removing the Cable Management Clip

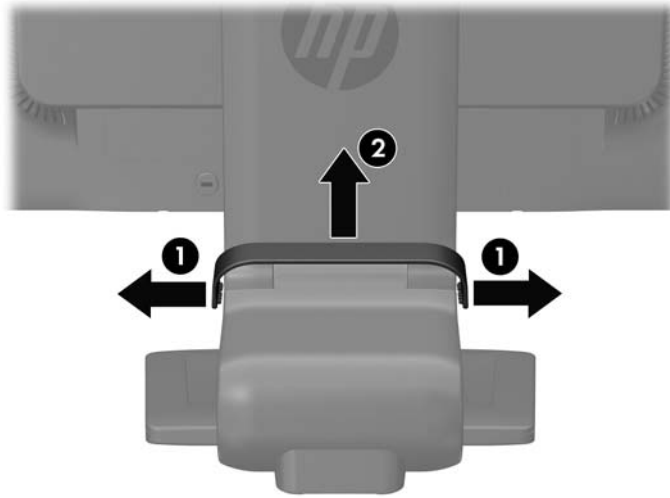

**Figure 2-4** Removing the Cable Management Clip (HP LA1956x Model)

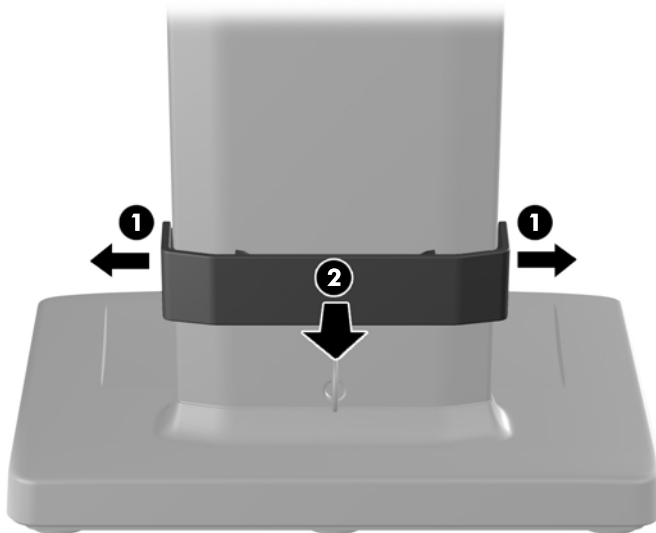

3. Connect a VGA signal cable, DVI-D signal cable, or DisplayPort signal cable. Refer to [Figure 2-5 Connecting the Cables on page 8](#) Figure 2-7 and [Figure 2-6 Connecting the Cables \(HP LA1956x Model\) on page 8](#) Figure 2-8.



**NOTE:** The monitor is capable of supporting either analog or digital input. The video mode is determined by the video cable used. The monitor will automatically determine which inputs have valid video signals. The inputs can be selected by pressing the **+ / source** button on the front panel or through the On-Screen Display (OSD) feature by pressing the **Menu** button.

- For analog operation, connect the VGA signal cable to the VGA connector on the rear of the monitor and the other end to the VGA connector on the computer (cable provided with select models).
  - For DVI digital operation, connect the DVI-D signal cable to the DVI connector on the rear of the monitor and the other end to the DVI connector on the computer (cable provided with select models).
  - For DisplayPort digital operation, connect the DisplayPort signal cable to the DisplayPort connector on the rear of the monitor and the other end to the DisplayPort connector on the computer (cable provided with select models).
4. Connect one end of the provided USB cable to the USB hub connector on the rear panel of the computer, and the other end to the upstream USB connector on the monitor.

5. Connect one end of the power cord to the AC power connector on the back of the monitor, and the other end to an electrical wall outlet.

**Figure 2-5** Connecting the Cables

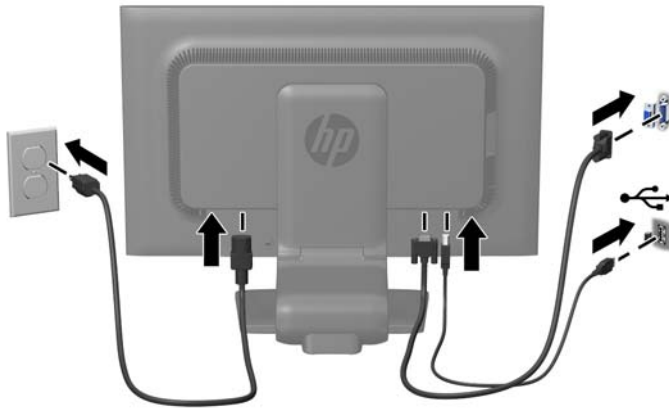

**Figure 2-6** Connecting the Cables (HP LA1956x Model)

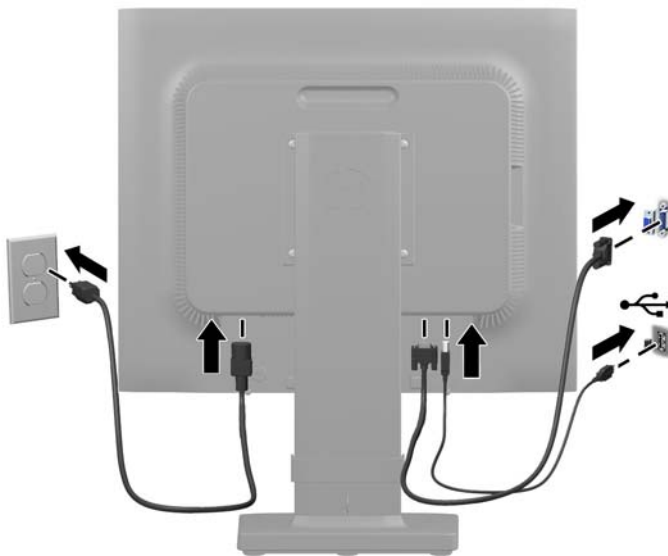

---

**⚠ WARNING!** To reduce the risk of electric shock or damage to the equipment:

Do not disable the power cord grounding plug. The grounding plug is an important safety feature. Plug the power cord into a grounded (earthed) electrical outlet that is easily accessible at all times.

Disconnect power from the equipment by unplugging the power cord from the electrical outlet.

For your safety, do not place anything on power cords or cables. Arrange them so that no one may accidentally step on or trip over them. Do not pull on a cord or cable. When unplugging from the electrical outlet, grasp the cord by the plug.

---

6. Secure the cables in place with the cable management clip. Press the clip straight down on the curved neck of the pedestal ensuring that the tabs on the sides of the clip snap into the slots on the pedestal.

**Figure 2-7** Installing the Cable Management Clip

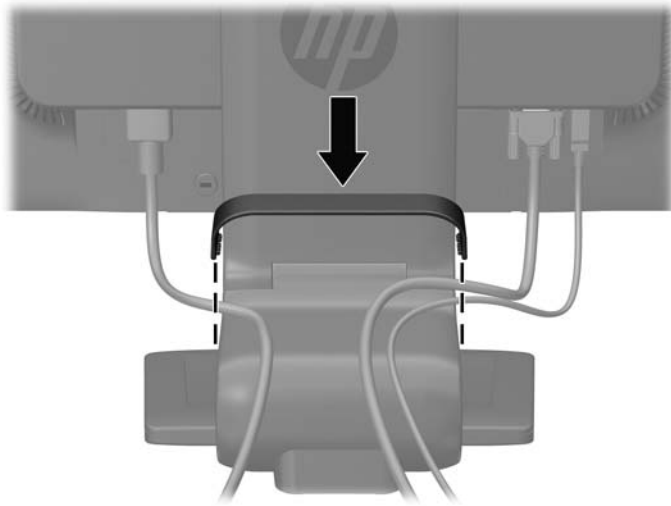

**Figure 2-8** Installing the Cable Management Clip (HP LA1956x Model)

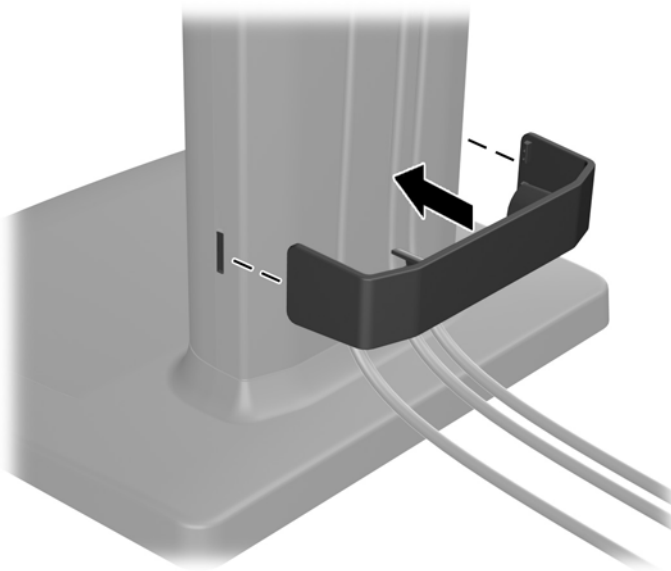

# Front Panel Controls

Figure 2-9 Monitor Front Panel Controls

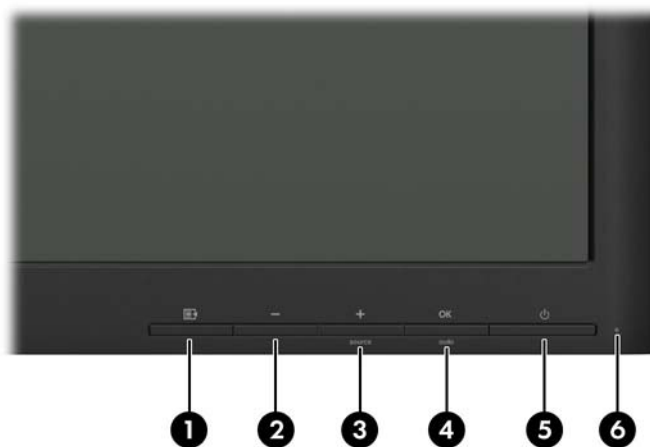









Table 2-1 Monitor Front Panel Controls

Control	Function
1  Menu	Opens, selects or exits the OSD menu.
2  Minus	If the OSD menu is on, press to navigate backward through the OSD menu and decrease adjustment levels.
3  Plus/source	If the OSD menu is on, press to navigate forward through the OSD menu and increase adjustment levels.  If the OSD menu is inactive, press to activate the source button that chooses the video signal input (VGA, DVI, or DisplayPort)
4  OK/auto	If the OSD menu is on, press to select the highlighted menu item.  If the OSD menu is inactive, press to activate the auto adjustment feature to optimize the screen image.
5  Power	Turns the monitor on or off.
6	Power LED  Blue = Fully powered.  Amber = Sleep mode.  Flashing Amber = Sleep Timer mode.

 **NOTE:** To view an OSD menu simulator, visit the HP Customer Self Repair Services Media Library at <http://www.hp.com/go/sml>.



# Adjusting the Monitor

 **NOTE:** Your monitor model may look different than the model in the following illustrations.

1. Tilt the monitor's panel forward or backward to set it to a comfortable eye level.

**Figure 2-10** Tilting the Monitor



2. Swivel the monitor to the left or right for the best viewing angle.

**Figure 2-11** Swiveling the Monitor

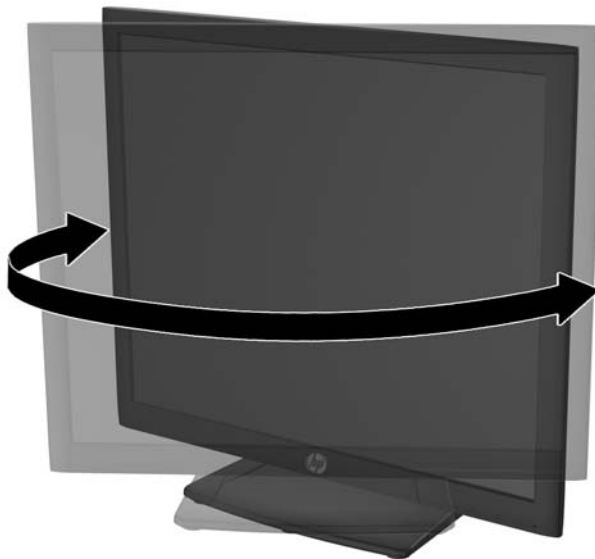

3. Adjust the monitor's height to a comfortable position for your individual workstation. The monitor's top bezel edge should not exceed a height that is parallel to your eye height. A monitor that is positioned low and reclined may be more comfortable for users with corrective lenses. The monitor should be repositioned as you adjust your working posture throughout the work day.

 **NOTE:** When the monitor is unfolded for the first time, the display head is locked from adjusting to a full-height position. To adjust the display head to full height, press down on the display head to unlock it then pull up on the display head to raise it to the full-height position.

**Figure 2-12** Adjusting the Height

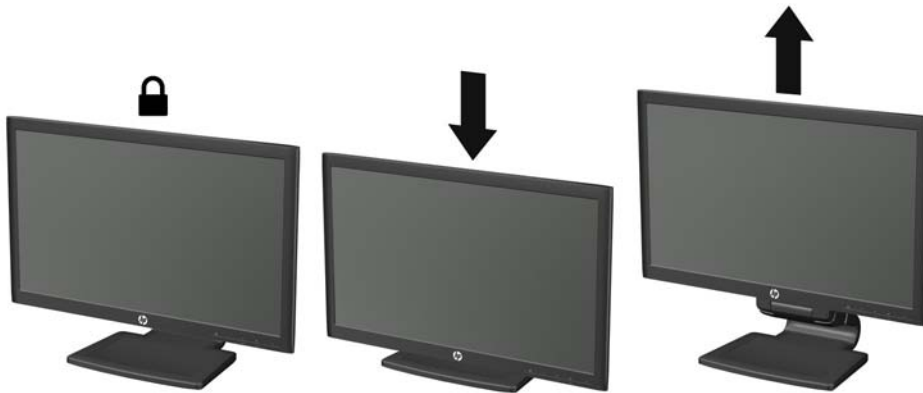

**Figure 2-13** Releasing the Lock Pin and Adjusting the Height (HP LA1956x Model)

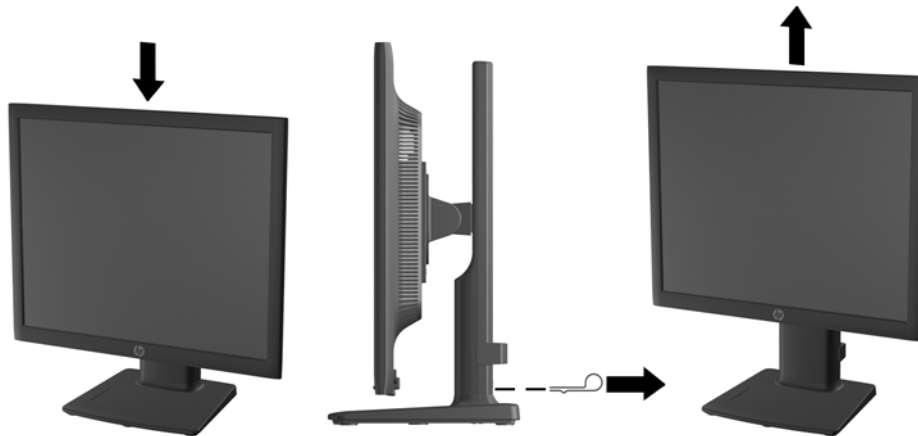

4. Pivot the monitor from landscape to portrait orientation viewing to adapt to your application.
  - a. Adjust the monitor to full height position and tilt the monitor back to full tilt position (1).
  - b. Pivot the monitor clockwise 90° from landscape to portrait orientation (2).

**CAUTION:** If the monitor is not in full height and full tilt position when pivoting, the bottom right corner of the monitor panel will come in contact with the base and potentially cause damage to the monitor.

If you are adding an optional speaker bar to the monitor, install it after pivoting the monitor. The speaker bar will come in contact with the base when pivoting and potentially cause damage to the monitor or speaker bar.

**Figure 2-14** Pivoting the Monitor

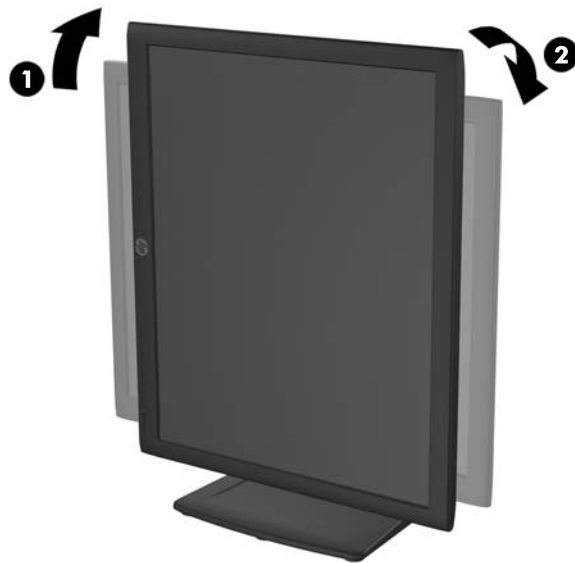

**NOTE:** To view information on the screen in portrait mode, you can install the HP Display Assistant software included on the software and documentation CD. The position of the OSD menu can also be rotated to portrait mode. To rotate the OSD menu, access the OSD menu by pressing the **Menu** button on the front panel, select **OSD Control** from the menu, then select **Rotate OSD**.

## Turning on the Monitor

1. Press the power button on the computer to turn it on.
2. Press the power button on the front of the monitor to turn it on.

**CAUTION:** Burn-in image damage may occur on monitors that display the same static image on screen for a prolonged period of time.\* To avoid burn-in image damage on the monitor screen, you should always activate a screen saver application or turn off the monitor when it is not in use for a prolonged period of time. Image retention is a condition that may occur on all LCD screens. Monitors with a “burned-in image” are not covered under the HP warranty.

\* A prolonged period of time is 12 consecutive hours of non-use.

 **NOTE:** If pressing the power button has no effect, the Power Button Lockout feature may be enabled. To disable this feature, press and hold the monitor power button for 10 seconds.

 **NOTE:** You can disable the power LED in the OSD menu. Press the [Menu](#) button on the front of the monitor, then select **Management > Bezel Power LED > Off**.

When the monitor is powered on, a Monitor Status message is displayed for five seconds. The message shows which input (DisplayPort, DVI, or VGA) is the current active signal, the status of the auto-switch source setting (On or Off; factory default is On), the default source signal (factory default is DisplayPort), the current preset display resolution, and the recommended preset display resolution.

The monitor automatically scans the signal inputs for an active input and uses that input for the display. If two or more inputs are active, the monitor will display the default input source. If the default source is not one of the active inputs, then the monitor will display the highest ranking priority input in the following order: DisplayPort, DVI, then VGA. You can change the default source in the OSD by pressing the front panel [Menu](#) button and selecting **Source Control > Default Source**.

## Connecting USB Devices

USB connectors are used to connect devices such as a digital camera, USB keyboard, or USB mouse. Two USB connectors are located on the side panel of the monitor.

 **NOTE:** You must connect the USB hub cable from the monitor to the computer to enable the USB 2.0 ports on the monitor. Refer to Step 4 in [Connecting the Cables on page 6](#).

**Figure 2-15** Connecting USB Devices

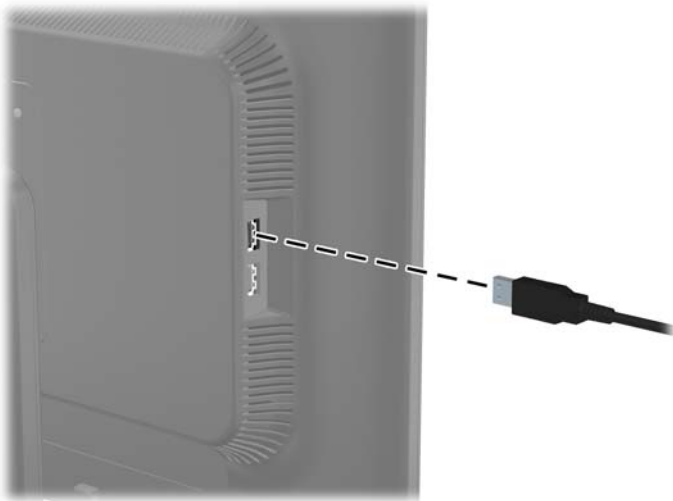

## Removing the Monitor Pedestal Base

You can remove the monitor panel from the pedestal base to install the panel on a wall, a swing arm, or other mounting fixture.

 **NOTE:** The following steps apply to the HP LA2006x, LA2206x, and LA2306x Models.

 **CAUTION:** Before beginning to disassemble the monitor, be sure the monitor is turned off and the power and signal cables are both disconnected. Also disconnect all USB cables connected to the monitor.

1. Disconnect and remove the signal, power, and USB cables from the monitor.
2. Lay the monitor face down on a flat surface covered by a clean, dry cloth.
3. Pivot the base 45 degrees clockwise and remove the screw from the back of the monitor, then pivot the base 45 degrees counter-clockwise and remove the other screw from the back of the monitor.

**Figure 2-16** Removing the Pedestal Base Screws



4. Rotate the base of the monitor up (1) then pull it back (2) to unhinge the tabs on the monitor stand from the slots in the monitor.

**Figure 2-17** Removing the Pedestal Base

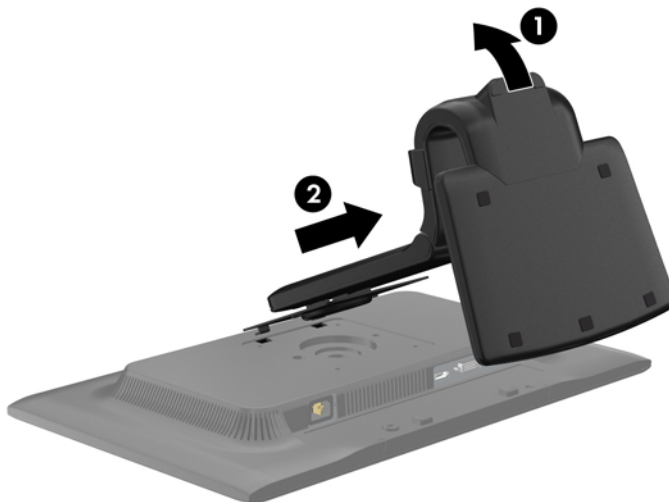

## Removing the Stand from the HP LA1956x Monitor

You can remove the monitor panel from the monitor stand to attach the panel to a wall, a swing arm, or another mounting fixture.

 **NOTE:** The following steps apply only to the HP LA1956x Model.

1. Lay the monitor face down on a flat surface covered by a clean, dry cloth.
2. Remove the four screws from the monitor stand.

**Figure 2-18** Removing the Screws from the Monitor Stand

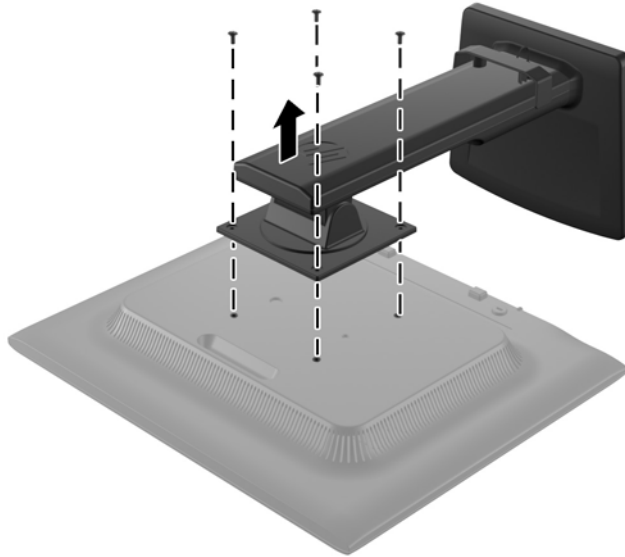

## Mounting the Monitor

The monitor panel can be attached to a wall, swing arm, or other mounting fixture.

 **NOTE:** This apparatus is intended to be supported by UL or CSA Listed wall mount bracket.

1. Remove the monitor panel from the pedestal base. Refer to [Removing the Monitor Pedestal Base on page 15](#).

 **CAUTION:** This monitor supports the VESA industry standard 100 mm mounting holes. To attach a third-party mounting solution to the monitor, four 4 mm, 0.7 pitch, and 10 mm long screws are required. Longer screws must not be used because they may damage the monitor. It is important to verify that the manufacturer's mounting solution is compliant with the VESA standard and is rated to support the weight of the monitor display panel. For best performance, it is important to use the power and video cables provided with the monitor.

2. To attach the monitor to a swing arm, insert four 10mm screws through the holes on the swing arm plate and into the mounting holes on the monitor.

**Figure 2-19** Mounting the Monitor

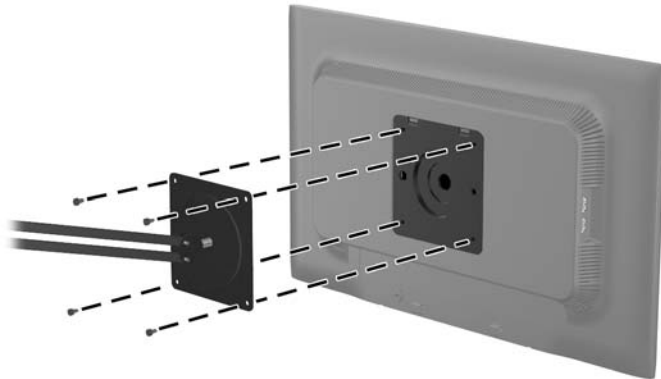

To attach the monitor to other mounting fixtures, follow the instructions included with the mounting fixture to ensure that the monitor is safely attached.

3. Reconnect the cables to the monitor panel.

## Locating the Rating Labels

The rating labels on the monitor provide the spare part number, product number, and serial number. You may need these numbers when contacting HP about the monitor model. The rating labels are located on the rear panel of the monitor display head.

**Figure 2-20** Locating the Rating Labels



## Installing a Cable Lock

You can secure the monitor to a fixed object with an optional cable lock available from HP.

**Figure 2-21** Installing a Cable Lock

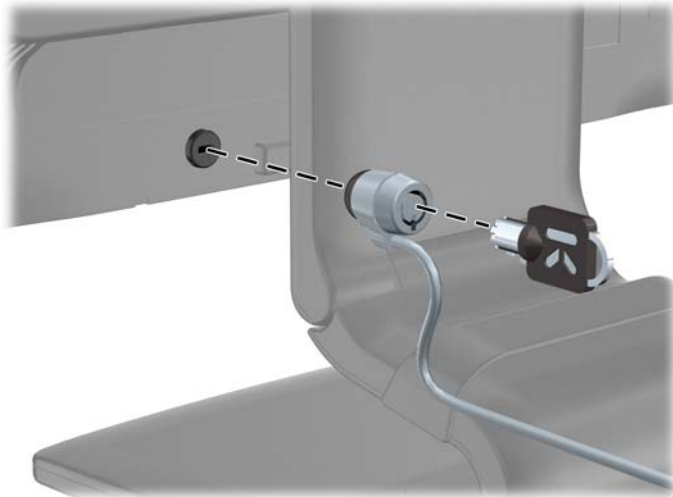



---

# 3 Finding More Information

## Reference Guides

Refer to the *HP LCD Monitors Reference Guide* included on the CD with your monitor for additional information on:

- Optimizing monitor performance
- Safety and maintenance guidelines
- Installing software from the CD
- Using the OSD menu
- Downloading software from the Web
- Agency regulatory information
- Troubleshooting and recommended solutions to common problems

For information on theft deterrence, refer to the *HP Display Assistant User Guide* included on the CD with your monitor.

## Product Support

For additional information on using and adjusting your monitor, go to <http://www.hp.com/support>. Select your country or region, select **Product Support & Troubleshooting**, and then enter your monitor model in the SEARCH window.

---

 **NOTE:** The monitor user guide, reference guide, and drivers are available at <http://www.hp.com/support>.

---

If the information provided in the guide or in the *HP LCD Monitors Reference Guide* do not address your questions, you can contact support. For U.S. support, go to <http://www.hp.com/go/contactHP>. For worldwide support, go to [http://welcome.hp.com/country/us/en/wwcontact\\_us.html](http://welcome.hp.com/country/us/en/wwcontact_us.html).

Here you can:

- Chat online with an HP technician

---

 **NOTE:** When support chat is not available in a particular language, it is available in English.

---

- E-mail support
- Find support telephone numbers
- Locate an HP service center

# A Technical Specifications



**NOTE:** All specifications represent the typical specifications provided by HP's component manufacturers; actual performance may vary either higher or lower.

## LA1956x Model

**Table A-1 LA1956x Specifications**

Display	48.3 cm wide screen	19 inches wide screen
Type	Twisted Nematic (TN) LED Backlit LCD	
Viewable Image Size	48.3 cm diagonal	19-inch diagonal
Tilt	-5 to 25°	
Swivel	-180 to 180°	
Maximum Weight (Unpacked)	4.5 kg	9.92 lbs
Dimensions (include base)		
Height (highest position)	48.64 cm	19.15 inches
Height (lowest position)	36.53 cm	14.38 inches
Depth	19.21 cm	7.56 inches
Width	41.78 cm	16.45 inches
Maximum Graphic Resolution	1280 x 1024 (60 Hz)	
Optimum Graphic Resolution	1280 x 1024 (60 Hz)	
Text Mode	720 x 400	
Dot Pitch	0.294 (H) x 0.294 (W) mm	
Pixels Per Inch	91.8 PPI	
Horizontal Frequency	24 to 83 kHz	
Vertical Refresh Rate	50 to 76 Hz	
Environmental Requirements Temperature		
Operating Temperature	5 to 35° C	41 to 95° F
Storage Temperature	-20 to 60° C	-4 to 140° F
Relative Humidity	20 to 80%	
Power Source	100 – 240 VAC 50/60 Hz	

**Table A-1 LA1956x Specifications (continued)**

Altitude:		
Operating	0 to 5000 m	0 to 16,400 feet
Storage	0 to 12192 m	0 to 40,000 feet
Measured Power Consumption:		
Full Power	35.0 watts	
Typical Settings	27.0 watts	
Energy Star® Test Methods	<15.95 watts	
Sleep	<0.5 watts	
Switch Off	<0.5 watts	
Input Terminal	One VGA connector, one DVI connector, and one DisplayPort connector (cables included with select models)	

## LA2006x Model

**Table A-2 LA2006x Specifications**

Display	50.8 cm wide screen	20 inches wide screen
Type	TFT LCD	
Viewable Image Size	50.8 cm diagonal	20-inch diagonal
Tilt	-5 to 30°	
Swivel	-180 to 180°	
Maximum Weight (Unpacked)	5.48 kg	12.1 lbs
Dimensions (include base)		
Height (highest position)	41.8 cm	16.46 inches
Height (lowest position)	31.63 cm	12.45 inches
Depth	21.63 cm	8.52 inches
Width	48.36 cm	19.04 inches
Maximum Graphic Resolution	1600 x 900 (60 Hz) analog input 1600 x 900 (60 Hz) digital input	
Optimum Graphic Resolution	1600 x 900 (60 Hz) analog input 1600 x 900 (60 Hz) digital input	
Text Mode	720 x 400	
Dot Pitch	0.2768 (H) x 0.2768 (V) mm	
Pixels Per Inch	91.8 PPI	
Horizontal Frequency	24 to 83 kHz	

**Table A-2 LA2006x Specifications (continued)**

Vertical Refresh Rate	50 to 76 Hz	
Environmental Requirements Temperature		
Operating Temperature	5 to 35° C	41 to 95° F
Storage Temperature	-20 to 60° C	-4 to 140° F
Relative Humidity	20 to 80%	
Power Source	100 – 240 VAC 50/60 Hz	
Altitude:		
Operating	0 to 5000 m	0 to 16,400 feet
Storage	0 to 12192 m	0 to 40,000 feet
Measured Power Consumption:		
Full Power	34.0 watts	
Typical Settings	29.0 watts	
Energy Star® Test Methods	24.5 watts	
Sleep	0.5 watts	
Switch Off	0.5 watts	
Input Terminal	One VGA connector with cable included; one DVI connector with cable included; one DisplayPort connector (cable not included)	

## LA2206x Model

**Table A-3 LA2206x Specifications**

Display	54.61 cm wide screen	21.5 inches wide screen
Type	TFT LCD	
Viewable Image Size	54.61 cm diagonal	22-inch diagonal
Tilt	-5 to 30°	
Swivel	-180 to 180°	
Maximum Weight (Unpacked)	6.0 kg	13.24 lbs
Dimensions (include base)		
Height (highest position)	43.87 cm	17.27 inches
Height (lowest position)	33.35 cm	13.13 inches
Depth	22.72 cm	8.94 inches
Width	51.8 cm	20.39 inches

**Table A-3 LA2206x Specifications (continued)**

Maximum Graphic Resolution	1920 x 1080 (60 Hz) analog input	
	1920 x 1080 (60 Hz) digital input	
Optimum Graphic Resolution	1920 x 1080 (60 Hz) analog input	
	1920 x 1080 (60 Hz) digital input	
Text Mode	720 x 400	
Dot Pitch	0.248 (H) x 0.248 (W) mm	
Pixels Per Inch	102 PPI	
Horizontal Frequency	24 to 94 kHz	
Vertical Refresh Rate	50 to 76 Hz	
Environmental Requirements Temperature		
Operating Temperature	5 to 35° C	41 to 95° F
Storage Temperature	-20 to 60° C	-4 to 140° F
Relative Humidity	20 to 80%	
Power Source	100 – 240 VAC 50/60 Hz	
Altitude:		
Operating	0 to 5000 m	0 to 16,400 feet
Storage	0 to 12192 m	0 to 40,000 feet
Measured Power Consumption:		
Full Power	38 watts	
Typical Settings	33 watts	
Energy Star® Test Methods	25 watts	
Sleep	0.5 watts	
Switch Off	0.5 watts	
Input Terminal	One VGA connector with cable included; one DVI connector with cable included; one DisplayPort connector (cable not included)	

## LA2306x Model

**Table A-4 LA2306x Specifications**

Display	58.42 cm wide screen	23 inches wide screen
Type	TFT LCD	
Viewable Image Size	58.42 cm diagonal	23-inch diagonal

**Table A-4 LA2306x Specifications (continued)**

Tilt	-5 to 30°	
Swivel	-180 to 180°	
Maximum Weight (Unpacked)	6.8 kg	15.0 lbs
Dimensions (include base)		
Height (highest position)	46.62 cm	18.37 inches
Height (lowest position)	35.11 cm	13.83 inches
Depth	24.95 cm	9.83 inches
Width	55.15 cm	21.73 inches
Maximum Graphic Resolution	1920 x 1080 (60 Hz) analog input 1920 x 1080 (60 Hz) digital input	
Optimum Graphic Resolution	1920 x 1080 (60 Hz) analog input 1920 x 1080 (60 Hz) digital input	
Text Mode	720 x 400	
Dot Pitch	0.265 (H) x 0.265 (W) mm	
Pixels Per Inch	95.8 PPI	
Horizontal Frequency	24 to 94 kHz	
Vertical Refresh Rate	50 to 76 Hz	
Environmental Requirements Temperature		
Operating Temperature	5 to 35° C	41 to 95° F
Storage Temperature	-20 to 60° C	-4 to 140° F
Relative Humidity	20 to 80%	
Power Source	100 – 240 VAC 50/60 Hz	
Altitude:		
Operating	0 to 5000 m	0 to 16,400 feet
Storage	0 to 12192 m	0 to 40,000 feet
Measured Power Consumption:		
Full Power	40 watts	
Typical Settings	35 watts	
Energy Star® Test Methods	33.1 watts	
Sleep	0.5 watts	
Switch Off	0.5 watts	
Input Terminal	One VGA connector with cable included; one DVI connector with cable included; one DisplayPort connector (cable not included)	

# Recognizing Preset Display Resolutions

The display resolutions listed below are the most commonly used modes and are set as factory defaults. This monitor automatically recognizes these preset modes and they will appear properly sized and centered on the screen.

## LA1956x Model

**Table A-5 Factory Preset Modes**

Preset	Pixel Format	Horz Freq (kHz)	Vert Freq (Hz)
1	640 × 480	31.469	59.94
2	720 × 400	31.469	70.087
3	800 × 600	37.879	60.317
4	1024 × 768	48.363	60.004
5	1280 × 1024	63.981	60.02

## LA2006x Model

**Table A-6 Factory Preset Modes**

Preset	Pixel Format	Horz Freq (kHz)	Vert Freq (Hz)
1	640 × 480	31.469	59.94
2	720 × 400	31.469	70.087
3	800 × 600	37.879	60.317
4	1024 × 768	48.363	60.004
5	1280 × 720	45.0	60.0
6	1280 × 1024	63.981	60.02
7	1440 × 900	55.935	59.887
8	1600 × 900	60.0	60.0

**Table A-7 High Definition Video Formats**

Preset	Timing Name	Pixel Format	Horz Freq (kHz)	Vert Freq (Hz)
1	480p	720 × 480	31.469	60
2	576p	720 × 576	31.25	50
3	720p50	1280 × 720	37.5	50
4	720p60	1280 × 720	45	60

## LA2206x Model

**Table A-8 Factory Preset Modes**

Preset	Pixel Format	Horz Freq (kHz)	Vert Freq (Hz)
1	640 × 480	31.469	59.940
2	720 × 400	31.469	70.087
3	800 × 600	37.879	60.317
4	1024 × 768	48.363	60.004
5	1280 × 720	45.00	59.94
6	1280 × 1024	63.981	60.02
7	1440 × 900	55.935	59.887
8	1680 × 1050	65.29	59.954
9	1920 × 1080	67.50	60.00

**Table A-9 High Definition Video Formats**

Preset	Timing Name	Pixel Format	Horz Freq (kHz)	Vert Freq (Hz)
1	480p	720 × 480	31.469	60
2	576p	720 × 576	31.25	50
3	720p50	1280 × 720	37.5	50
4	720p60	1280 × 720	45	60
5	1080p50	1920 × 1080	56.25	50
6	1080p60	1920 × 1080	67.5	60

## LA2306x Model

**Table A-10 Factory Preset Modes**

Preset	Pixel Format	Horz Freq (kHz)	Vert Freq (Hz)
1	640 × 480	31.469	59.940
2	720 × 400	31.469	70.087
3	800 × 600	37.879	60.317
4	1024 × 768	48.363	60.004
5	1280 × 720	45.00	60.00
6	1280 × 1024	63.981	60.02
7	1440 × 900	55.935	59.887



**Table A-10 Factory Preset Modes (continued)**

8	1680 × 1050	65.29	59.954
9	1920 × 1080	67.5	60.00

**Table A-11 High Definition Video Formats**

Preset	Timing Name	Pixel Format	Horz Freq (kHz)	Vert Freq (Hz)
1	480p	720 × 480	31.469	60
2	576p	720 × 576	31.25	50
3	720p50	1280 × 720	37.5	50
4	720p60	1280 × 720	45	60
5	1080p50	1920 × 1080	56.25	50
6	1080p60	1920 × 1080	67.5	60

## Entering User Modes

The video controller signal may occasionally call for a mode that is not preset if:

- You are not using a standard graphics adapter.
- You are not using a preset mode.

If this occurs, you may need to readjust the parameters of the monitor screen by using the on-screen display. Your changes can be made to any or all of these modes and saved in memory. The monitor automatically stores the new setting, then recognizes the new mode just as it does a preset mode. In addition to the factory preset modes, there are at least 10 user modes that can be entered and stored.

## Energy Saver Feature

The monitors support a reduced power state. The reduced power state will be entered into if the monitor detects the absence of either the horizontal sync signal and/or the vertical sync signal. Upon detecting the absence of these signals, the monitor screen is blanked, the backlight is turned off, and the power light is turned amber. When the monitor is in the reduced power state, the monitor will utilize .5 watts of power. There is a brief warm up period before the monitor will return to its normal operating mode.

Refer to the computer manual for instructions on setting energy saver features (sometimes called power management features).



**NOTE:** The above power saver feature only works when connected to computers that have energy saver features.

By selecting the settings in the monitor's Energy Saver utility, you can also program the monitor to enter into the reduced power state at a predetermined time. When the monitor's Energy Saver utility causes the monitor to enter the reduced power state, the power light blinks amber.