

HANNSpree



HANNSpree

19"
**Liquid Crystal Display
Monitor**

MAF-001002

M19W2/M19N2

User's Manual

HANNSPREE, INC.
www.hannspree.com

Table of Contents

REGULATORY INFORMATION	2
RECYCLING INFORMATION	4
SAFETY NOTICE	5
PREFACE	8
BEFORE YOU OPERATE THE MONITOR	9
FEATURES.....	9
CHECKING THE CONTENTS OF THE PACKAGE	9
POWER	10
CONTROLS AND CONNECTORS	11
ADJUSTING THE VIEWING ANGLE.....	13
OPERATING INSTRUCTIONS	14
GENERAL INSTRUCTIONS	14
FRONT PANEL CONTROL	15
HOW TO ADJUST A SETTING	16
TECHNICAL SUPPORT (FAQ)	25
TROUBLE SHOOTING.....	25
ERROR MESSAGE & POSSIBLE SOLUTION.....	26
APPENDIX	29
SPECIFICATIONS	29
CONNECTOR PIN ASSIGNMENT	31



REGULATORY INFORMATION

Before operating the monitor, please read this manual thoroughly. This manual should be retained for future reference.

FCC Class B Radio Frequency Interference Statement

This equipment has been tested and found to comply with the limits for a Class B digital device, pursuant to part 15 of the FCC Rules. These limits are designed to provide reasonable protection against harmful interference in a residential installation. This equipment generates, uses and can radiate radio frequency energy and, if not installed and used in accordance with the instructions, may cause harmful interference to radio communications. However, there is no guarantee that interference will not occur in a particular installation. If this equipment does cause harmful interference to radio or television reception, which can be determined by turning the equipment off and on, the user is encouraged to try to correct the interference by one or more of the following measures:

- Reorient or relocate the receiving antenna.
- Increase the separation between the equipment and receiver.
- Connect the equipment into an outlet on a circuit different from that to which the receiver is connected.
- Consult the dealer or an experienced radio/TV technician for help.

This device complies with part 15 of the FCC Rules. Operation is subject to the following two conditions: (1) This device may not cause harmful interference, and (2) this device must accept any interference received, including interference that may cause undesired operation.

CANADA

This Class B digital apparatus meets all requirements of the Canadian Interference-Causing Equipment Regulation.



This device complies with requirement of EMC directive 89/336/EEC with regard to Electromagnetic Compatibility, and 73/23/EEC and 93/68/EEC with regard to Low Voltage directive.

Socket-outlet shall be near the equipment and shall be accessible.

TCO'03 (TCO'03 applied model only)



Congratulations!

The display you have just purchased carries the TCO'03 Displays label. This means that your display is designed, manufactured and tested according to some of the strictest quality and environmental requirements in the world. This makes for a high performance product, designed with the user in focus that also minimizes the impact on our natural environment.

Some of the features of the TCO'03 Display requirements:

Ergonomics

- Good visual ergonomics and image quality in order to improve the working environment for the user and to reduce sight and strain problems. Important parameters are luminance, contrast, resolution, reflectance, color rendition and image stability.

Energy

- Energy-saving mode after a certain time - beneficial both for the user and the environment
- Electrical safety

Emissions

- Electromagnetic fields
- Noise emissions

Ecology

- The product must be prepared for recycling and the manufacturer must have a certified environmental management system such as EMAS or ISO 14 001.
- Restrictions on
 - chlorinated and brominated flame retardants and polymers
 - heavy metals such as cadmium, mercury and lead.

The requirements included in this label have been developed by TCO Development in cooperation with scientists, experts, users as well as manufacturers all over the world. Since the end of the 1980s TCO has been involved in influencing the development of IT equipment in a more user-friendly direction. Our labelling system started with displays in 1992 and is now requested by users and IT-manufacturers all over the world.

For more information, please visit
www.tcodevelopment.com



RECYCLING INFORMATION

HANNspree Inc. cares about environmental protection strategies and in using manufacturing methods and treatments that lend themselves to conservation and recycling devices at the end-of-life.

Our products, whenever possible, contain recyclable materials which can be recycled into new devices. When necessary for operation, other materials may be classified as hazardous or poisonous substances. We strongly encourage you to research the provided information about recycling this device.

For more information, please visit
www.Hannspree.com



SAFETY NOTICE

1. Changes or modifications not expressly approved by the party responsible for compliance could void the user's authority to operate the equipment.
2. Shielded interface cables and AC power cord, if any, must be used in order to comply with the emission limits.
3. The manufacturer is not responsible for any radio or TV interference caused by unauthorized modification to this equipment. It is the responsibilities of the user to correct such interference.

WARNING:

To prevent fire or shock hazard, do not expose the monitor to rain or moisture. Dangerously high voltages are present inside the monitor. Do not open the cabinet. For all service issues, please refer to qualified personnel only.

PRECAUTIONS

- Do not use the monitor near water, e.g. near a bathtub, washbowl, kitchen sink, laundry tub, swimming pool or in a wet basement.
- Do not place the monitor on an unstable cart, stand, or table. If the monitor falls, it can injure a person and cause serious damage to the appliance. Use only a cart or stand recommended by the manufacturer or sold with the monitor. If you mount the monitor on a wall or shelf, use a mounting kit approved by the manufacturer and follow the kit instructions.
- Slots and openings in the back and bottom of the cabinet are provided for ventilation. To ensure reliable operation of the monitor and to protect it from overheating, be sure these openings are not blocked or covered. Do not place the monitor on a bed, sofa, rug, or similar surface. Do not place the monitor near or over a radiator or heat register. Do not place the monitor in a bookcase or cabinet unless proper ventilation is provided.
- The monitor should be operated only from the type of power source indicated on the label. If you are not sure of the type of power supplied to your home, consult your dealer or local power company.
- Unplug the unit during a lightening storm or when it will not be used for long period of time. This will protect the monitor from damage due to power surges.
- Do not overload power strips and extension cords. Overloading can result in fire and / or electric shock.

-
- Never push any object into the slot on the monitor cabinet. It could short circuit parts causing a fire or electric shock. Never spill liquids on the monitor.
 - Do not attempt to service the monitor by yourself; opening or removing covers can expose you to dangerous voltages and other hazards. Please refer all service issues to qualified service personnel.
 - To ensure satisfactory operation, use the monitor only with UL listed computers which have appropriate configured receptacles marked between 100 - 240V AC, Min. 5A.
 - The wall socket shall be installed near the equipment and shall be easily accessible.
 - Do not install the monitor in a location near heat sources such as radiators or air ducts, or in a place subject to direct sunlight, or excessive dust or mechanical vibration or shock.
 - Save the original carton and packing materials, as they will come in handy if you ever have to ship your monitor.
 - To ensure problem-free shipping, pack your monitor in the same packing materials and carton as it was shipped from the factory.
 - To keep the monitor looking new, periodically clean it with a soft cloth. Stubborn stains may be removed with a cloth lightly dampened with a mild detergent solution. Never use strong solvents such as paint thinners, benzene, or abrasive cleaning products. These and other harsh cleaning agents will damage the cabinet of the monitor.

SPECIAL NOTES ON LCD MONITORS

The following symptoms are normal with LCD monitor and do not indicate a problem.

- Due to the nature of the fluorescent light, the screen may flicker during initial use. Turn off the Power Switch and then turn it on again to make sure the flicker disappears.
- You may find slightly uneven brightness on the screen depending on the desktop pattern you use.
- The LCD screen has effective pixels of 99.99% or more. It may include blemishes of 0.01% or less such as a missing pixel or a pixel lit all of the time.

-
- Due to the nature of LCD screens, an after image of the previous displayed content may remain if this image has been the displayed for several hours. The LCD screen should recover if the image is changed or powered off for several hours.
 - If the screen suddenly flashes erratically or the backlighting fails, please contact your dealer or service center for repair. Do not attempt to repair the monitor yourself.



PREFACE

Thank you for purchasing a Hannspree Liquid Crystal Display Monitor (LCD Monitor).

Please carefully read this manual in its entirety before setting up, using or operating your Monitor. To ensure the safe and correct installation and operations of the Monitor, it is important that the safety and operation instructions in this manual are followed.

This instruction manual is designed to assist you in setting up and using the Monitor. The information in this manual has been carefully checked for accuracy; however, no guarantee is given to the correctness of the contents. The information in this manual is subject to change without notice.

To the extent allowed by applicable law, Hannspree, Inc. ("Hannspree") shall not be liable for direct, indirect, special, exemplary, incidental or consequential damages arising from any defect or omission in this manual, even if advised of the possibility of such damages in advance.

© 2007 Hannspree Specifications and design are subject to change without notice. All brand, product, service names and logos are trademarks and/or registered trademarks of their respective manufacturers and companies. Screen shots are simulated.



BEFORE YOU OPERATE THE MONITOR

FEATURES

- 19" screen TFT Color LCD Monitor
- Crisp, Clear Display
- Recommended Resolutions:
19" Wide (16:10) 1440 X 900
19" (5:4) 1280 X 1024
- EPA ENERGY STAR
- Ergonomic Design
- Space Saving, Compact Case Design
- HDMI 1.1 Compatibility

CHECKING THE CONTENTS OF THE PACKAGE

The product package should include the following items:

LCD Monitor

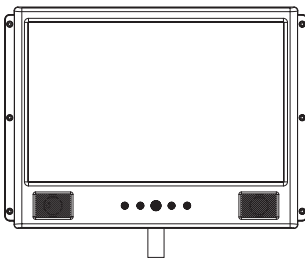

Screen

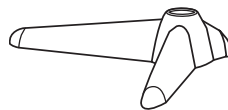

Base

* Note: The screen and base designs will vary from model to model. For more information, please refer to the Quick Start Guide included with your monitor.

Cables and User manual



Power Cord



D-SUB Cable

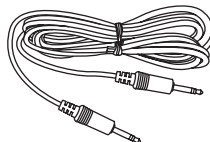

Audio Cable

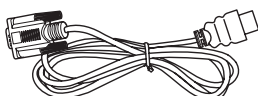

DVI-D/HDMI Cable
(Optional)



HDMI Cable
(Optional)

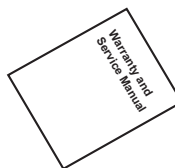

Warranty and
Service Manual

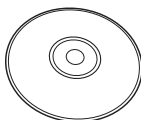

CD ROM
(including User's manual)

* Note: Images are for illustration only and may vary by model or region.

POWER

POWER SOURCE:

1. Make sure that the power cord is the correct type required in your area.
2. This LCD monitor has an Internal universal power supply that allows operation in either 100/120V AC or 220/240V AC voltage area (No user adjustment is required.)
3. Plug one end of the AC-power cord into the LCD monitor's AC input socket and the other into a surge protection power strip or device.



CONTROLS AND CONNECTORS

CABLE CONNECTIONS

Turn off your computer before performing the procedure below.

1. Connect one end of the 15-pin D-SUB cable to the back of the monitor and connect the other end to the computer's D-SUB port.
-or-
2. Connect one end of a 19-pin HDMI to the back of the monitor. Connect the other end to the computer's 24-pin DVI-D port.
-or-
3. Connect one end of a 19-pin HDMI to the back of the monitor. Connect the other end to an HDMI device, such as a DVD.

* Note: This monitor is capable of operating in 'Dual input' mode. Only one of either the 15-pin D-SUB or the HDMI (via HDMI cable or HDMI to DVI-D adapter) connections is needed for normal operation.
4. Connect the audio cable between the monitor's audio input and the PC's audio output (green port). This connection is optional and not required for normal operation of the monitor.
5. Plug one end of the AC-power cord into the LCD monitor's AC input socket and the other into a surge protection power strip or device.
6. Turn on your monitor and computer.

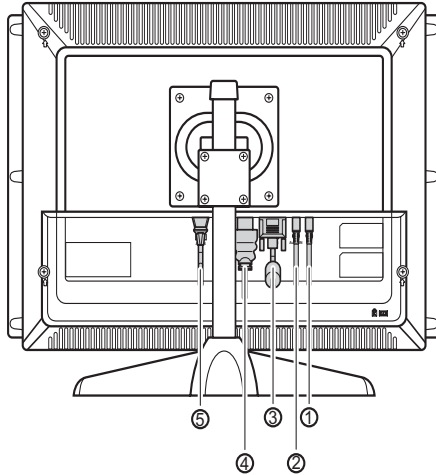

Figure 1. Connecting Cables

1	Headphone Jack	2	Audio In
3	D-SUB Input	4	HDMI Input
5	Power AC Input		

ADJUSTING THE VIEWING ANGLE

- For optimal viewing it is recommended to look at the full face of the monitor, then adjust the monitor's angle to your own preference.
- Hold the stand so you do not topple the monitor when changing the screen's angle.
- You are able to adjust the monitor's angle at 20° alternative from -5° to 15° or 0° to 20°.
- For more information, please refer to the Quick Start Guide of your Monitor model.

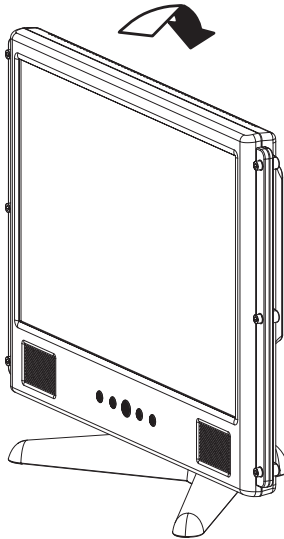

Figure 2. Monitor's angle

NOTES:

- Avoid touching the LCD screen when changing the viewing angle as it may cause damage.
- Be careful not to place fingers or hands near the hinges when tilting the monitor, otherwise pinching can result.



OPERATING INSTRUCTIONS

GENERAL INSTRUCTIONS

Press the power button to turn the monitor on or off. The other control buttons are located at front panel of the monitor (See Figure 3). By changing these settings, the picture can be adjusted to your personal preferences.

- The power cord should be connected.
- Connect the Signal cable from the monitor to the computer.
- Press the power button to turn on the monitor. The LED will turn green.

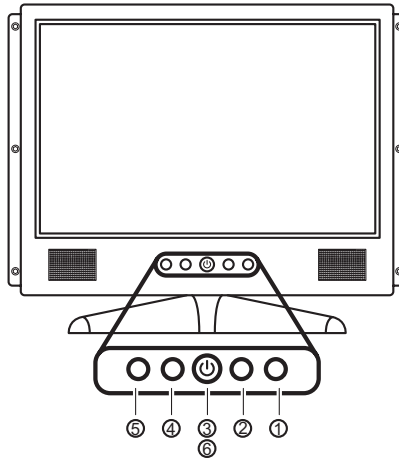

Figure 3. External Control Buttons

EXTERNAL CONTROLS:

1	MENU	2	VOL + ►
3	POWER	4	◀ VOL -
5	AUTO	6	Power Indicator (LED)

FRONT PANEL CONTROL

- **Power Button:**

Press this button to switch the monitor on and off.

- **Power Indicator (LED):**

Green — Power On mode

Orange — Power Saving mode

- **MENU / ENTER:**

1. Activate the OSD menu or adjust the function settings and confirmation.
2. Exit OSD menu when in volume OSD status.
3. Confirm the selection when in Auto Adjustment/Source Select OSD.

- **◀ VOL- / VOL+ ▶**



1. Activate the volume control when the OSD is OFF.
2. Navigate through adjustment icons when OSD is ON or adjust a function when function is activated.
3. Press both volume buttons simultaneously over 0.5 second to mute the sound. (Selected model only)



- **Auto Adjust button:**

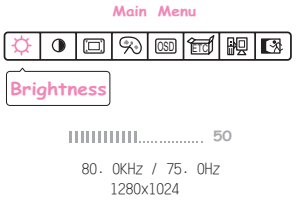
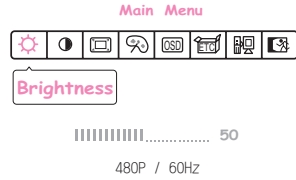

When OSD menu is in off status, press this button to activate the Auto Adjustment/Source Select OSD. Use the volume buttons to select a setting, and press the MENU button to confirm.

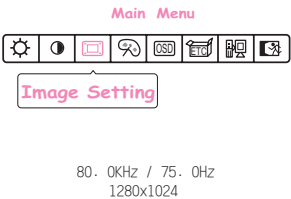
(The Adjust function is used to optimize the H-Position, V-Position, Clock and Phase automatically.)

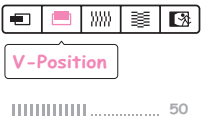
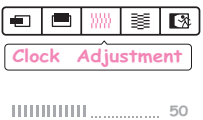
HOW TO ADJUST A SETTING

OSD	Description
 <p>Main Menu</p> <p>Brightness</p> <p>80. 0kHz / 75. 0Hz 1280x1024</p>  <p>Main Menu</p> <p>Brightness</p> <p>480P / 60Hz</p>	<p>Brightness adjustment:</p> <p>Select the “Brightness” option from the Main Menu. Press MENU key and adjust the level.</p> <p>In D-SUB input, main menu OSD can show PC input timing.</p> <p>Brightness adjustment:</p> <p>Select the “Brightness” option from the Main Menu. Press MENU key and adjust the level.</p> <p>In HDMI input, main menu OSD can show HDMI input timing.</p>
 <p>Main Menu</p> <p>Contrast</p> <p>80. 0kHz / 75. 0Hz 1280x1024</p>	<p>Contrast adjustment:</p> <p>Select the “Contrast” option from the Main Menu. Press MENU key and adjust the level.</p>
 <p>Main Menu</p> <p>Image Setting</p> <p>80. 0kHz / 75. 0Hz 1280x1024</p>	<p>How to adjust screen position and quality:</p> <p>Select “Image Setting” from the Main Menu, and then press MENU key to access the “Image Setting” (for D-SUB input) or “HDMI Setting” menu (for HDMI input).</p>

<p style="text-align: center;">Image Setting</p>  <p style="text-align: center;">H-Position</p> <p style="text-align: center;"> 50</p>	<p>Horizontal position adjustment:</p> <p>Select the “H-position” option to shift the screen image to the left or right. Press MENU key and adjust the level.</p>
<p style="text-align: center;">Image Setting</p>  <p style="text-align: center;">V-Position</p> <p style="text-align: center;"> 50</p>	<p>Vertical position adjustment:</p> <p>Select the “V-position” option to shift the screen image up or down. Press MENU key and adjust the level.</p>
<p style="text-align: center;">Image Setting</p>  <p style="text-align: center;">Clock Adjustment</p> <p style="text-align: center;"> 50</p>	<p>Clock adjustment:</p> <p>Select the “Clock Adjustment” option to reduce the vertical flicker of characters on the screen. Press MENU key and adjust the level.</p>
<p style="text-align: center;">Image Setting</p>  <p style="text-align: center;">Phase Adjustment</p> <p style="text-align: center;"> 50</p>	<p>Phase adjustment:</p> <p>Select the “Phase Adjustment” option to reduce the horizontal flicker of characters on the screen. Press MENU key and adjust the level.</p>

<p>HDMI Setting</p>  <p>Normal Vivid</p>	<p>Video mode:</p> <p>Select the “Video Mode” option to set the image quality when using the HDMI input. Press MENU key to select Normal or Vivid.</p>
<p>HDMI Setting</p>  <p>High Low</p>	<p>Backlight Mode:</p> <p>Select the “Backlight Mode” option to adjust the backlight for the display brightness when using the HDMI input. Press MENU key to select High or Low.</p>
<p>Main Menu</p>  <p>80. 0KHz / 75. 0Hz 1280x1024</p>	<p>How to adjust color:</p> <p>Select the “Color Setting” option on the Main Menu and then press MENU.</p>

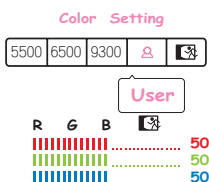
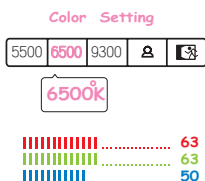

Change Color Settings for D-SUB source:

Move the cursor to one of the preset options and select it.

Change Color Settings for D-SUB source:

Move the cursor to the User option and select it.

1. To adjust the red, enter the “R” option and adjust the level.
2. To adjust the green, enter the “G” option and adjust the level.
3. To adjust the blue, enter the “B” option and adjust the level.

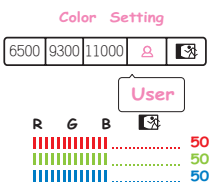
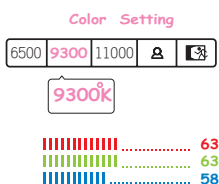





Change Color Settings for HDMI source:





Move the cursor to one of the preset options and select it.



Change Color Settings for HDMI source:



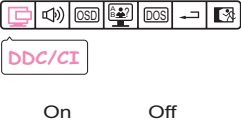

Move the cursor to the User option and select it.

1. To adjust the red, enter the “R” option and adjust the level.
2. To adjust the green, enter the “G” option and adjust the level.
3. To adjust the blue, enter the “B” option and adjust the level.

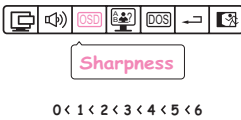
<p style="text-align: center;">Main Menu</p>  <p style="text-align: center;">80. 0KHz / 75. 0Hz 1280x1024</p>	<p>How to set the OSD:</p> <p>Select “OSD Setting” from the Main Menu, and then press MENU key.</p>
<p style="text-align: center;">OSD Setting</p> 	<p>OSD horizontal adjustment:</p> <p>Select the “OSD H-Position” option to adjust the horizontal position of the OSD. Press MENU key and adjust the level.</p>
<p style="text-align: center;">OSD Setting</p> 	<p>OSD vertical position adjustment:</p> <p>Select the “OSD V-Position” option to adjust the vertical position of the OSD. Press MENU key and adjust the level.</p>
<p style="text-align: center;">OSD Setting</p> 	<p>OSD timer setting:</p> <p>Select the “OSD Time-out” option to set the OSD time out from 5 to 100 seconds. Press MENU key and adjust the level.</p>

<p style="text-align: center;">OSD Setting</p>  <p style="text-align: center;">OSD Transparency</p> <p style="text-align: center;">0 < 1 < 2 < 3 < 4 < 5 < 6</p>	<p>OSD Transparency setting:</p> <p>Select the “OSD Transparency” option to adjust the transparency of the OSD. Press MENU key and adjust the level.</p>												
<p style="text-align: center;">OSD Setting</p>  <p style="text-align: center;">OSD Color</p> <p style="text-align: center;">1 2 3 4 5 6</p>	<p>OSD color setting:</p> <p>Select the “OSD Color” setting option to adjust the color of the OSD. Press MENU key and adjust the level.</p>												
<p style="text-align: center;">OSD Setting</p>  <p style="text-align: center;">Language</p> <table style="margin-left: auto; margin-right: auto;"> <tr> <td>繁體中文</td> <td>簡體中文</td> </tr> <tr> <td>日本語</td> <td>한국어</td> </tr> <tr> <td>English</td> <td>Deutsch</td> </tr> <tr> <td>Français</td> <td>Español</td> </tr> <tr> <td>Italiano</td> <td>Português</td> </tr> <tr> <td colspan="2" style="text-align: center;">Nederlands</td> </tr> </table>	繁體中文	簡體中文	日本語	한국어	English	Deutsch	Français	Español	Italiano	Português	Nederlands		<p>Language:</p> <p>Select the “Language” option to change the language of the OSD. Press MENU key and select a language.</p> <p>(Please note the diagram is for reference only. The OSD Language options may vary by model and region.)</p>
繁體中文	簡體中文												
日本語	한국어												
English	Deutsch												
Français	Español												
Italiano	Português												
Nederlands													
<p style="text-align: center;">Main Menu</p>  <p style="text-align: center;">Other Setting</p> <p style="text-align: center;">80. 0KHz / 75. 0Hz 1280x1024</p>	<p>Select the “Other Setting” option to access more settings.</p>												

<p style="text-align: center;">Other Setting</p>  <p style="text-align: center;">On Off</p>	<p>DDC/CI:</p> <p>When DDC/CI is enabled, users are allowed to configure the software monitor settings in Windows Vista. Select the “DDC/CI” option to enable or disable the DDC/CI support for the Windows OS. Press MENU key to select On or Off. (Used by D-SUB input)</p> <p>Note: Windows, Vista are registered trademarks of Microsoft Corporation.</p>
<p style="text-align: center;">Other Setting</p>  <p style="text-align: center;">50</p>	<p>Volume adjustment:</p> <p>Select the “Volume” option to change the volume level. Press MENU key and adjust the level.</p>
<p style="text-align: center;">Other Setting</p>  <p style="text-align: center;">0 < 1 < 2 < 3 < 4 < 5 < 6</p>	<p>Sharpness:</p> <p>Select the “Sharpness” option to adjust the sharpness of the display. Set the value from 0 to 6.</p>

<p style="text-align: center;">Other Setting</p>  <p style="text-align: center;">Near Timing Mode</p> <p style="text-align: center;">On Off</p>	<p>Near Timing Mode:</p> <p>Select the “Near Timing Mode” option to enable or disable this function. Press MENU key to select On or Off.</p>
<p style="text-align: center;">Other Setting</p>  <p style="text-align: center;">DOS Mode</p> <p style="text-align: center;">720X400 640X400</p>	<p>DOS mode:</p> <p>Select the “DOS mode” option to set the monitor for use with PC. Press MENU key and select 720 x 400 or 640 x 400.</p>
<p style="text-align: center;">Other Setting</p>  <p style="text-align: center;">Factory Preset</p> <p style="text-align: center;">On Off</p>	<p>Recall the factory settings:</p> <p>Select the “Factory Preset” option to reset to the monitor’s default setting. This will erase the current settings. Press MENU key and select On or Off.</p>
<p style="text-align: center;">Main Menu</p>  <p style="text-align: center;">Input Setting</p> <p style="text-align: center;">D-SUB DVI-D HDMI</p> <p style="text-align: center;">80. 0kHz / 75. 0Hz 1280x1024</p>	<p>Input Setting:</p> <p>Select the “Input Setting” option to change between the analog (D-SUB) or Digital (DVI/HDMI) source. Press MENU key and select Analog or Digital input.</p>

PLUG AND PLAY (Plug & Play DDC2B Feature)

This monitor is equipped with VESA DDC2B capabilities according to the VESA DDC STANDARD. It allows the monitor to inform the computer or host system of its identity and, depending on the level of DDC used, communicate additional information about its display capabilities. The DDC2B is a bidirectional data channel based on the protocol. The host can request EDID information over the DDC2B channel.

If your computer, video card, and operating system support DDC2B, your monitor should automatically be set to it's optimal configuration. Some computer systems may not have the capability to properly detect this information. In addition, some computer systems will require manually configuring the video options. In most cases, software and/or driver updates will correct this issue. Please contact your computer or video card manufacturer for more details.

THIS MONITOR WILL APPEAR TO BE NON-FUNCTIONAL IF THERE IS NO VIDEO INPUT SIGNAL. IN ORDER FOR THIS MONITOR TO OPERATE PROPERLY, THERE MUST BE A VIDEO INPUT SIGNAL.

The monitor detects the input source automatically if only one of the D-SUB or HDMI/DVI-D ports is in use. In dual input mode (when both ports are in use), the monitor automatically selects the D-SUB source for the settings.

This monitor meets the Green monitor standards as set by the Video Electronics Standards Association (VESA) and/or the United States Environmental Protection Agency (EPA) and The Swedish Confederation Employees (NUTEK). This feature is designed to conserve electrical energy by reducing power consumption when there is no video-input signal present. When there is no video input signal this monitor, following a time-out period, will automatically switch to an OFF mode. This reduces the monitor's internal power supply consumption. After the video input signal is restored, full power is restored and the display is automatically redrawn. The appearance is similar to a "Screen Saver" feature except the display is completely off. The display is restored by pressing a key on the keyboard, or clicking the mouse.

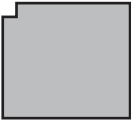

TECHNICAL SUPPORT (FAQ)

TROUBLE SHOOTING

PROBLEM	POSSIBLE SOLUTION
Power LED is not on	<ul style="list-style-type: none">• Check the power cord.
No Plug & Play or screen image is stretched / seems out of proportion.	<ul style="list-style-type: none">• Check if the PC system is Plug & Play compatible.• Check if the Video Card is Plug & Play compatible.• Inspect the monitor's video cable for bent or broken pins.
Picture is dim, too bright or fuzzy	<ul style="list-style-type: none">• Adjust the Clock, Phase or Contrast and Brightness Controls.
Picture bounces or a wave pattern is present in the picture	<ul style="list-style-type: none">• Reposition electrical devices that may cause electrical interference.
The power LED is ON (orange) but there's no video or no picture.	<ul style="list-style-type: none">• Computer Power Switch should be in the ON position.• Computer Video Card should be snugly seated in its slot.• Make sure monitor's video cable is properly connected to the computer.• Inspect monitor's video cable and make sure none of the pins are bent.• Make sure computer is operational by hitting the CAPS LOCK key on the keyboard while observing the CAPS LOCK LED. The LED should either turn ON or OFF after hitting the CAPS LOCK key.
Missing one of the primary colors (RED, GREEN, or BLUE)	<ul style="list-style-type: none">• Inspect the monitor's video cable for bent or broken pins.

Screen image is not centered or sized properly.	<ul style="list-style-type: none"> Adjust pixel frequency CLOCK and PHASE or press hot-key (AUTO).
Picture has color defects (white does not look white)	<ul style="list-style-type: none"> Adjust RGB color or select color temperature.
Horizontal or vertical disturbances on the screen	<ul style="list-style-type: none"> Use Windows 95/98/2000/NT/ME/XP; "shut-down mode. Adjust CLOCK" and PHASE or perform hot-key (AUTO).

ERROR MESSAGE & POSSIBLE SOLUTION

- CABLE NOT CONNECTED :**

1. Check whether the signal-cable is properly connected. If the connector is loose, tighten the connector screws.
2. Check the signal-cable's connection pins for damage.

- OUT OF RANGE :**

Your computer has been set to an unsuitable display mode. Set the computer to a display mode from the tables on the following pages:

FACTORY PRESET TIMING TABLE:

TIMING	MODE	HORIZONTAL FREQUENCY (kHz)	VERTICAL FREQUENCY (Hz)
640x350	VGA-350	31.469	70.087
640x400	VGA-GRAPH	31.469	70.087
640x480	VGA-480	31.469	59.94
640x480	APPLE MAC-480	35.00	66.67
640x480	VESA-480-72Hz	37.861	72.809
640x480	VESA-480-75Hz	37.5	75
720x400	VGA-400-TEXT	31.469	70.087
832x624	APPLE MAC-800	49.725	74.55
800x600	SVGA	35.156	56.25
800x600	VESA-600-60Hz	37.879	60.317
800x600	VESA-600-72Hz	48.077	72.188
800x600	VESA-600-75Hz	46.875	75
1024x768	XGA	48.363	60.004
1024x768	COMPAQ-XGA	53.964	66.132
1024x768	VESA-768-70Hz	56.476	70.069
1024x768	VESA-768-75Hz	60.023	75.029
1024x768	APPLE MAC-768	60.24	75.02
1152x864	75Hz	67.50	75.00
1280x960	60Hz	60.00	60.00
1280x1024	VESA-1024-60Hz	64	60
1280x1024	VESA-1024-75Hz	80	75
* 1440x900	VESA-1440-60Hz	55.935	59.887
* 1440x900	VESA-1440-75Hz	70.635	75
* 1360x768	VESA-1360-768- 60Hz	47.712	60.015

* The three timing modes are for 19" widescreen support only.

HDMI TIMING TABLE:

MODE	TIMING	RESOLUTION	V-FREQ.(Hz)
1	VGA/60 Hz	640x480p	59.94/60
2	720p/60 Hz	1280x720p	59.94/60
3	1080i/60 Hz	1920x1080i	59.94/60
4	480p/60 Hz	720x480p	59.94/60
5	480i/60 Hz	720(1440)x480i	59.94/60
6	720p/50 Hz	1280x720p	50
7	1080i/50 Hz	1920x1080i	50
8	576p/50 Hz	720x576p	50
9	576i/50 Hz	720(1440)x576i	50



APPENDIX

SPECIFICATIONS

LCD Panel	Model NO.	M19W2	M19N2
	Display size	19"(16:10)	19"(5:4)
	Pixel Pitch	0.2835(H)x0.2835(V)	0.294(H)x0.294(V)
Input	Video	R.G.B. Analog Interface Digital (Dual-Input Model) H/V TTL	
	H-Frequency	31KHz-80KHz	
	V-Frequency	56-75HZ	
Display Colors		16.2M Colors	
Max. Resolution		1440 x 900	1280 x 1024
Plug & Play		VESA DDC2B	
EPA ENERGY STAR	ON Mode	≤ 36W	
	OFF Mode	≤ 1W	
Audio maximum power output		<1.1 W (Amplifier) <1.4 mW / 32 ohm (Earphone)	
Input Connector		D-SUB 15pin HDMI 19pin	
Maximum Screen Size		Hor.:408.24mm Ver.:255.15mm	Hor.:376.32mm Ver.:301.056mm
Power Source		100~240VAC, 50~60HZ	
Environmental Considerations		Operating Temp: 5 to 35 C Storage Temp.: -20 to 60 C Operating Humidity: 10%~85%, non-condensing	

Dimensions (W*D*H)	LM08: 610*535*210 mm LM01: 465*193*482 mm LM02: 485*212*402 mm LM03: 449*293*416 mm LM05: 449*180*409 mm Max: 485*293*482 mm
Weight (GW/NW)	Max. 8kg/6.5kg
Regulatory Compliance	UL/CUL, BSMI, CCC, CE, CB, PSB, FCC, VCCI, C-TICK NEMKO-GS*, TCO'03*

The above specification is subject to actual panel specification and is subject to change without prior notice.

* Applies to specific compliant models only.

Note:

Maximum Resolution is dependant on the support of your computer system and video card. Please see <http://www.hannspree.com> for more information.

CONNECTOR PIN ASSIGNMENT

- 15-Pin Color Display Signal Cable:

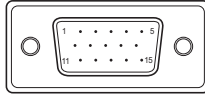

PIN NO.	DESCRIPTION	PIN NO.	DESCRIPTION
1	Red	9	+5V
2	Green	10	Cable Detection
3	Blue	11	Ground
4	Ground	12	DDC-Serial Data
5	Ground	13	H-Sync
6	R-Ground	14	V-Sync
7	G-Ground	15	DDC-Serial Clock
8	B-Ground		

- HDMI Color Display Signal Cable:



PIN NO.	DESCRIPTION	PIN NO.	DESCRIPTION
1	TMDS Data 2+	11	Clock shield
2	TMDS Data 2 shield	12	Clock -
3	TMDS Data 2-	13	CEC
4	TMDS Data 1+	14	NC
5	TMDS Data 1 shield	15	DDC CLK
6	TMDS Data 1-	16	DDC Data

7	TMDS Data 0+	17	CEC/GND
8	TMDS Data 0 shield	18	+5V Power
9	TMDS Data 0-	19	Hot Plug Detect
10	Clock +		

• **24-Pin Color Display Signal Cable: (Dual Input Mode)**

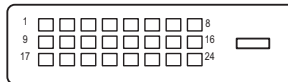

PIN NO.	DESCRIPTION	PIN NO.	DESCRIPTION
1	TMDS Data 2-	13	No Connecting
2	TMDS Data 2+	14	+5V Power
3	TMDS Data 2/4 Shield	15	Ground(for +5V)
4	No Connection	16	Hot Plug Detect
5	No Connection	17	TMDS Data 0-
6	DDC Clock	18	TMDS Data 0+
7	DDC Data	19	TMDS Data 0/5 Shield
8	NC	20	No Connection
9	TMDS Data 1-	21	No Connection
10	TMDS Data 1+	22	TMDS Clock Shield
11	TMDS Data 1/3 Shield	23	TMDS Clock +
12	No Connection	24	TMDS Clock -

HANNSPREE North America, Inc.

TEL: 1-510-360-3080

Toll Free : 1-888-808-6789

FAX:1-510-360-3001

Corporate website :

<http://www.hannspree.com/us>

Service website :

<http://usservice.hannspree.net>

Service Email :

webservice_us@hannspree.com

Australia

Phone: 1-300-HANNSPREE (1-300-426677)

Corporate website :

<http://www.hannspree.com/au>

Service website :

<http://auservice.hannspree.net>

New Zealand

Phone: 0-800-HANNSPREE(0-800-426677)

Corporate website :

<http://www.hannspree.com/nz>

Service website :

<http://nzservice.hannspree.net>

Europe GmbH

TEL: +49 (0) 2154 953 23-0

FAX: +49 (0) 2154 953 23-123

Corporate website :

<http://www.hannspree.com/eu>

Service website :

<http://euservice.hannspree.net>

瀚斯寶麗股份有限公司

電話 : 886-2-87518000

傳真 : 886-2-87514755

Corporate website :

<http://www.hannspree.com/tw>

Service website :

<http://twservice.hannspree.net>

瀚斯宝丽科技(上海)有限公司

电话: +86.21.3912.6999

传真: +86.21.3912.6969

Corporate website :

<http://www.hannspree.com/cn>

Service website :

<http://cnservice.hannspree.net>

Hannspree Hong Kong Service Center

TEL: (852) 23453822

FAX: (852) 23453790

Corporate website :

<http://www.hannspree.com/hk>

Service website :

<http://hkservice.hannspree.net>

Japan

電話番号: 03.6914.5088

ファックス: 03.6914.5087

Corporate website :

<http://www.hannspree.com/jp>

Service website :

<http://jpservice.hannspree.net>