

HANNING
LED Monitor
HL225

HSG 1147

- User's manual
- Bedienungsanleitung
- Manuel de l'utilisateur
- Manuale dell'utente
- Manual de usuario
- Manual do utilizador
- Gebruikshandleiding
- Руководство пользователя
- Kullanıcı elkitabı
- Podręcznik użytkownika
- Uživatelská příručka
- Felhasználói útmutató
- Εγχειρίδιο χρήστη
- Manual de utilizare
- Priručnik za korisnike
- Керівництво користувача
- Ръководство на потребителя
- Brugervejledning
- Användarhandbok
- Bruksanvisning
- Käyttäjän ohjekirja
- ユーザーズマニュアル
- 使用手冊
- 使用手冊
- 사용자 설명서

Before operating the monitor, please read this manual thoroughly. This manual should be retained for future reference.

FCC Class B Radio Frequency Interference Statement

This equipment has been tested and found to comply with the limits for a Class B digital device, pursuant to Part 15 of the FCC Rules. These limits are designed to provide reasonable protection against harmful interference in a residential installation. This equipment generates, uses and can radiate radio frequency energy, and if not installed and used in accordance with the instructions, may cause harmful interference to radio communications. However, there is no guarantee that interference will not occur in a particular installation. If this equipment does cause harmful interference to radio or television reception, which can be determined by turning the equipment off and on, the user is encouraged to try to correct the interference by one or more of the following measures:

- Reorient or relocate the receiving antenna.
- Increase the separation between the equipment and receiver.
- Connect the equipment into an outlet on a circuit different from that to which the receiver is connected.
- Consult the dealer or an experienced radio/TV technician for help.

The device complies with Parts 15 of the FCC Rule. Operation is subject to the following two conditions: (1) this device may not cause harmful interference; and (2) this device must accept any interference received, including interference that may cause undesired operations.

CANADA

This Class B digital apparatus meets all requirements of the Canadian Interference-Causing Equipment Regulation.



This device complies with requirement of EMC directive 2004/108/EC with regard to Electromagnetic Compatibility, and 73/23/EEC and 93/68/EEC with regard to Low Voltage directive.

Socket-outlet shall be near the equipment and shall be accessible.

Congratulations!

This display is designed for both you and the planet!



The display you have just purchased carries the TCO Certified label. This ensures that your display is designed, manufactured and tested according to some of the strictest quality and environmental requirements in the world. This makes for a high performance product, designed with the user in focus that also minimizes the impact on the climate and our natural environment.

TCO Certified is a third party verified program, where every product model is tested by an accredited impartial test laboratory. TCO Certified represents one of the toughest certifications for displays worldwide.

Some of the Usability features of the TCO Certified for displays:

- Good visual ergonomics and image quality is tested to ensure top performance and reduce sight and strain problems. Important parameters are luminance, contrast, resolution, black level, gamma curve, color and luminance uniformity, color rendition and image stability
- Product have been tested according to rigorous safety standards at an impartial laboratory
- Electric and magnetic fields emissions as low as normal household background levels
- Low acoustic noise emissions

Some of the Environmental features of the TCO Certified for displays:

- The brand owner demonstrates corporate social responsibility and has a certified environmental management system (EMAS or ISO 14001)
- Very low energy consumption both in on- and standby mode minimize climate impact
- Restrictions on chlorinated and brominated flame retardants, plasticizers, plastics and heavy metals such as cadmium, mercury and lead (RoHS compliance)
- Both product and product packaging is prepared for recycling
- The brand owner offers take-back options

The requirements can be downloaded from our web site. The requirements included in this label have been developed by TCO Development in co-operation with scientists, experts, users as well as manufacturers all over the world. Since the end of the 1980s TCO has been involved in influencing the development of IT equipment in a more user-friendly direction. Our labeling system started with displays in 1992 and is now requested by users and IT-manufacturers all over the world. About 50% of all displays worldwide are TCO certified.

For more information, please visit
www.tcodevelopment.com

Mandate:

For displays that have a gloss value $G(60^\circ) > 30$ gloss units the following consideration note for the placement of the FPD shall be given in the user manual.

“For displays with glossy bezels the user should consider the placement of the display as the bezel may cause disturbing reflections from surrounding light and bright surfaces.”

RECYCLING INFORMATION

We, the **Hanns.G** care very much about our environment protection strategy and firmly believe that it helps us have healthier earth via appropriate treatment and recycling of industrial technology devices at the end-of-life.

These devices contain recyclable materials, which can be re-decomposed and re-integrated into brand-new marvels. On the contrary, other material can be classified to hazardous and poisoned substances. We strongly encourage you to contact the provided information to recycle this product.

For more information, please visit
www.hannsg.com

TABLE OF CONTENTS

SAFETY NOTICE	6
PRECAUTIONS.....	6
SPECIAL NOTES ON LCD MONITORS	7
BEFORE YOU OPERATE THE MONITOR.....	8
FEATURES.....	8
CHECKING THE CONTENTS OF THE PACKAGE	8
INSTALLATION INSTRUCTIONS	9
POWER.....	9
SETTING THE MONITOR ON THE WALL	10
MAKING CONNECTIONS.....	11
ADJUSTING THE VIEWING ANGLE.....	12
OPERATING INSTRUCTIONS	13
GENERAL INSTRUCTIONS.....	13
FRONT PANEL CONTROL	14
HOW TO ADJUST A SETTINGS	16
PLUG AND PLAY.....	19
TECHNICAL SUPPORT (FAQ)	20
Q & A FOR GENERAL PROBLEMS	20
ERROR MESSAGE & POSSIBLE SOLUTIONS	22
APPENDIX	24
SPECIFICATIONS.....	24

SAFETY NOTICE

1. The changes or modifications not expressly approved by the party responsible for compliance could void the user's authority to operate the equipment.
2. Shielded interface cables and AC power cord, if any, must be used in order to comply with the emission limits.
3. The manufacturer is not responsible for any radio or TV interference caused by unauthorized modification to this equipment. It is the responsibilities of the user to correct such interference.
4. Only use attachments/accesories specified by the manufacturer.

WARNING:

To prevent fire or shock hazard, do not expose the monitor to rain or moisture. Dangerously high voltages are present inside the monitor. Do not open the cabinet. Refer servicing to qualified personnel only.

PRECAUTIONS

- Do not use the monitor near water, e.g. near a bathtub, washbowl, kitchen sink, laundry tub, swimming pool or in a wet basement.
- Do not place the monitor on an unstable cart, stand, or table. If the monitor falls, it can injure a person and cause serious damage to the appliance. Use only a cart or stand recommended by the manufacturer or sold with the monitor. If you mount the monitor on a wall or shelf, use a mounting kit approved by the manufacturer and follow the kit instructions.
- Slots and openings in the back and bottom of the cabinet are provided for ventilation. To ensure reliable operation of the monitor and to protect it from overheating, be sure these openings are not blocked or covered. Do not place the monitor on a bed, sofa, rug, or similar surface. Do not place the monitor near or over a radiator or heat register. Do not place the monitor in a bookcase or cabinet unless proper ventilation is provided.
- The monitor should be operated only from the type of power source indicated on the label. If you are not sure of the type of power supplied to your home, consult your dealer or local power company.
- Unplug the unit during a lightning storm or when it will not be used for long period of time. This will protect the monitor from damage due to power surges.
- Do not overload power strips and extension cords. Overloading can result in fire or electric shock.
- Never push any object into the slot on the monitor cabinet. It could short circuit parts causing a fire or electric shock. Never spill liquids on the monitor.
- Do not attempt to service the monitor by yourself; opening or removing covers can expose you to dangerous voltages and other hazards. Please refer all servicing to qualified service personnel.
- The wall socket shall be installed near the equipment and shall be easily accessible.

SPECIAL NOTES ON LCD MONITORS

The following symptoms are normal with LCD monitor and do not indicate a problem.

- Due to the nature of the fluorescent light, the screen may flicker during initial use. Turn off the Power Switch and then turn it on again to make sure the flicker disappears.
- You may find slightly uneven brightness on the screen depending on the desktop pattern you use.
- The LCD screen has effective pixels of 99.99% or more. It may include blemishes of 0.01% or less such as a missing pixel or a pixel lit all of the time.
- Due to the nature of the LCD screen, an afterimage of the previous screen may remain after switching the image, when the same image is displayed for hours. In this case, the screen is recovered slowly by changing the image or turning off the Power Switch for hours.
- If the screen suddenly flashes erratically or the backlighting fails, please contact your dealer or service center for repair. Do not attempt to repair the monitor yourself.

BEFORE YOU OPERATE THE MONITOR

FEATURES

- 54,6cm / 21.5" Wide Screen W-LED Backlight Monitor
- Crisp, Clear Display for Windows
- EPA ENERGY STAR®
- GP Green Product
- Ergonomic Design
- Space Saving, Compact Case Design

CHECKING THE CONTENTS OF THE PACKAGE

The product package should include the following items:

LCD Monitor



Cables and User manual



Warranty Card



Quick Start Guide

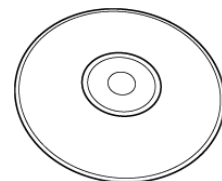

User's Manual

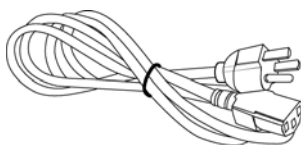

Power Cord

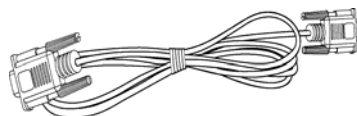

VGA Cable

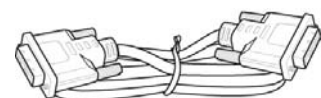

DVI Cable (Optional)

INSTALLATION INSTRUCTIONS

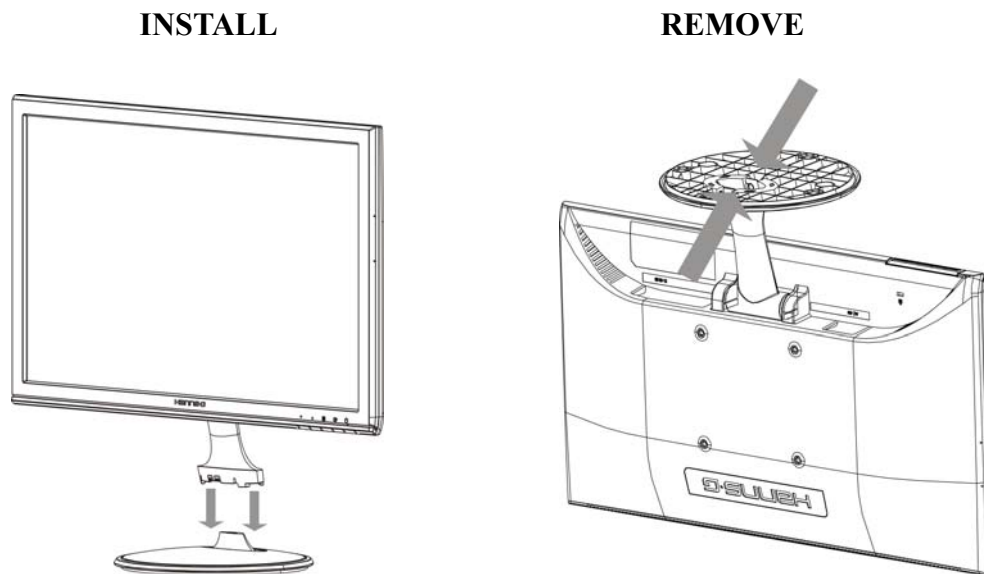

Figure.1. Installing and Removing the Base

INSTALLATION:

1. Align the monitor with the opening in the base.
2. Note that the longer section of the base points forward.
3. Snap the monitor into its base. A clear click sound will affirm that the base is connected correctly.
4. Verify that the monitor is securely attached to the base by looking at the bottom of the base and making sure that the clips are fully engaged in the base.

REMOVAL:

1. Flip over the monitor so that it is upside down.
2. Press the 2 clips on the base that holds the monitor in place.
3. Gently press and hold the 2 clips while pulling the base from the monitor unit they are unattached.

POWER

POWER SOURCE:

1. Make sure that the power cord is the correct type required in your area.
2. This LCD monitor has an Internal universal power supply that allows operation in either 100/120V AC or 220/240V AC voltage area (No user adjustment is required.)
3. Connect the AC-power cord one end to your LCD monitor's AC-input socket, the other end to wall-outlet.

SETTING THE MONITOR ON THE WALL

DISSEMBLING THE STAND BASE:

1. Disconnect all the cables and cords from the Monitor to prevent breakage.
2. Carefully place the Monitor face down on a soft and flat surface (blanket, foam, cloth, etc) to prevent any damage to the Monitor.
3. Squeeze the sides to release the retaining plastic tabs and pull the stand cover off.
4. Gently remove the stand base.

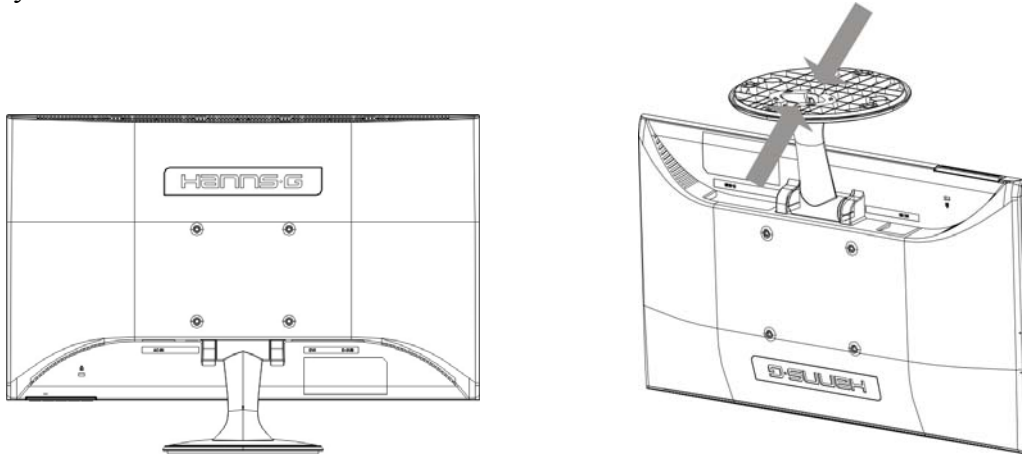

(For reference only)

WALL MOUNTING THE MONITOR:

1. Purchase a VESA compatible wall bracket:
VESA 100X100, 4 holes, M4, 10mm, 8kg.
2. Locate your ideal Monitor position on the wall.
3. Fix the wall bracket firmly on the wall.
4. Secure the Monitor to the bracket using the 4 mount holes on the back and center of the Monitor.

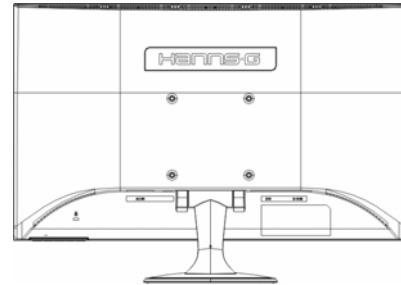

Note:

- Please read the instructions of your specific wall bracket to properly wall mount the Monitor.
- The pitch of the mounting holes is 100mm horizontally and 100mm vertically.
- The screws type required is metric: M4, 10mm length.
- The Monitor stand base can be screwed on a table or a hard surface using the hole on the back of the stand base.

**Installing the LCD Monitor requires special skill that should only be performed by qualified service personnel. Customers should not attempt to do the work themselves. Hanns.G bears no responsibility for improper mounting or mounting that results in accident or injury. You can ask a qualified service personnel about using an optional bracket to mount the Monitor to the wall.*

MAKING CONNECTIONS

CONNECTING TO A PC

Turn off your computer before performing the procedure below.

1. Connect one end of the D-Sub cable to the back of the monitor and connect the other end to the computer's D-Sub port.
2. Connect one end of the DVI-D to the back of the monitor and connect the other end to the computer's DVI-D port.
3. Plug one end of the AC power cord to the LCD monitor's AC input socket, and the other end to Wall outlet.
4. Turn on your monitor and computer.

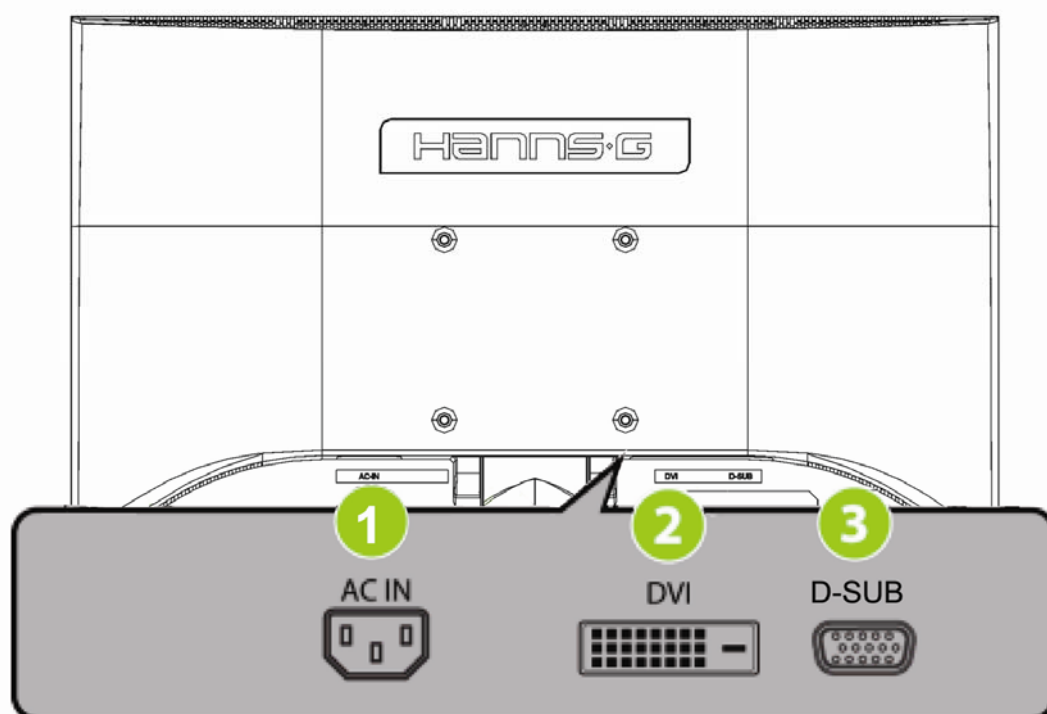

Figure.2. Connecting to a PC

1	Power AC Input	2	DVI Input
3	VGA Input		

ADJUSTING THE VIEWING ANGLE

- For optimal viewing it is recommended to look at the full face of the monitor, then adjust the monitor's angle to your own preference.
- Hold the stand so you do not topple the monitor when you change the monitor's angle.
- You are able to adjust the monitor's angle from -5° to 15° .

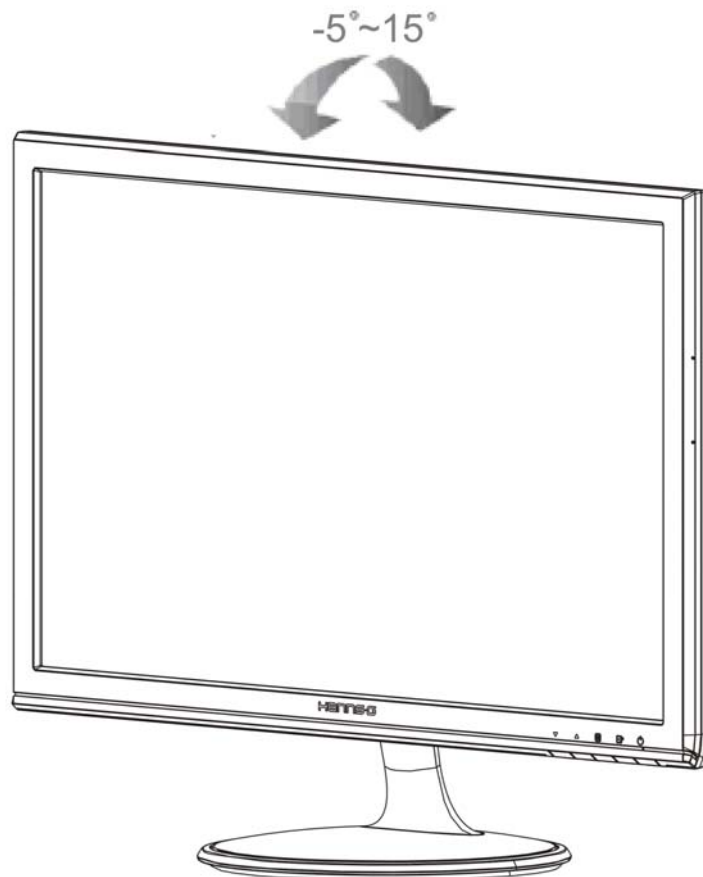

Figure.3. Monitor Angle

NOTES:

- Do not touch the LCD screen when you change the angle. It may cause damage or break the LCD screen.
- Be careful not to place fingers or hands near the hinges when tilting the monitor, otherwise pinching can result.

OPERATING INSTRUCTIONS

GENERAL INSTRUCTIONS

Press the power button to turn the monitor on or off. The other control buttons are located on the front panel of the monitor (See Figure 4). By changing these settings, the picture can be adjusted to your personal preferences.

- The power cord should be connected.
- Connect the Signal cable from the monitor to the VGA card.
- Press the power button to turn on the monitor. The power indicator will light up.





	Menu / Return
	▲ [-] Brightness adjustment button
	▼ [+]
	Auto adjustment/ Enter 《Analog Input Models》 Input source change/ Enter 《Digital Input Models》
	Power Button

Figure.4. Control Panel Buttons

FRONT PANEL CONTROL

- **Power Button:**

Press this button to switch ON/OFF of monitor's power.

- **Power Indicator:**

Green — Power On mode.

Orange — Power Saving mode.

- **MENU / RETURN:**

Turn the OSD menu on/off or return to the previous menu.

- **Adjust ▲▼:**

1. Adjust Brightness when the OSD is off.

2. Navigate through adjustment icons when OSD is ON or adjust a function when function is activated.

- **【 i 】 Button:** 《Analog Input Models》

1. The OSD menu is used as 《confirmation》 function during start-up.

2. The 「Auto adjustment」 function works only for VGA input. (The auto adjustment function is used to optimize the 「horizontal position」, 「vertical position」, 「clock」, and 「phase」.)

- **【 i 】 Button:** 《Digital Input Models》

1. Press【 i 】to enter Source selections. (Selections include VGA, HDMI, etc. The actual selections may vary depending on the models. This function is only available in models with digital inputs)

2. The OSD menu is used as 《confirmation》 function during start-up.

3. Press and hold this button more than 3 seconds will start 「Auto Adjust」 function when using VGA input only. (The auto adjustment function is used to optimize the 「horizontal position」, 「vertical position」, 「clock」, and 「phase」.)

- **Hotkeys:**

- 1. **Restore Brightness and Contrast defaults:**

To reset both the Brightness and Contrast to their default values, press the 【▲】 and 【▼】 keys at the same time after Enter Brightness or Contrast Menu.

- 2. **ASPECT RATIO:**

Press 【MENU】 + 【▼】 key to change to 「FULL MODE」 or 「FIT MODE」.

- 3. **Change Resolution:**

For similar screen display resolutions (see table below), the screen resolution can be changed by pressing the 【MENU】 + 【▲】 button to achieve the optimal display quality.

- 4. **Change Preset Mode:** [The availability of this function depends upon the selected model]

Press【MENU】key for 3 seconds to select one of the following modes「PC」,「MOVIE」,「GAME」, 「ECO」. Default is 「PC」.

Resolution
640x400@70Hz ↔ 720x400@70Hz
640x400@85Hz ↔ 720x400@85Hz
640x480@60Hz ↔ 720x480@60Hz
1280x768@60Hz ↔ 1360x768@60Hz
1400x1050@60Hz ↔ 1680x1050@60Hz
1400x1050@RB 60Hz ↔ 1680x1050@RB 60Hz
** The screen resolutions available will depend on the purchased model.

NOTES:

- Do not install the monitor in a location near heat sources such as radiators or air ducts, or in a place subject to direct sunlight, or excessive dust or mechanical vibration or shock.
- Save the original shipping box and packing materials, as they will come in handy if you ever have to ship your monitor.
- For maximum protection, repackage your monitor as it was originally packed at the factory.
- To keep the monitor looking new, periodically clean it with a soft cloth. Stubborn stains may be removed with a cloth lightly dampened with a mild detergent solution. Never use strong solvents such as thinner, benzene, or abrasive cleaners, since these will damage the cabinet. As a safety precaution, always unplug the monitor before cleaning it.

HOW TO ADJUST A SETTINGS

BRIGHTNESS/ CONTRAST	
BRIGHTNESS	Adjust the brightness value of the display according to your preference. Select 「 BRIGHTNESS 」 option to adjust the brightness value.
CONTRAST	Adjust the contrast value of the display according to your preference. Select 「 CONTRAST 」 option to adjust the contrast value.
X-CONTRAST	Optimal setting for high contrast images or videos. The dark and light areas of the image are automatically detected, and the contrast is enhanced to provide a clearer, sharper image. Also, you may select the 「 X-CONTRAST 」 option.
PRESET MODE	Select the display mode according to your preference. Select 「 PRESET MODE 」 option to select the display mode.
INPUT SETTING	
INPUT SETTING	Select the 「 INPUT SETTING 」 option to change between analog (VGA) or Digital (DVI) source. Enter the option and select Analog or Digital.
AUTO SEARCH	From the Signal Selection menu, select the 「 AUTO SEARCH 」 option to activate or deactivate the automatic signal search function. [For DVI Input only]
COLOR SETTING	
WARM NATURE (6500K) COOL	Adjust the color temperature value of the display according to your preference: WARM /NATURE/ COOL.
USER	Move the cursor to the User option and select it, 1. To adjust the red, enter the 「 R 」 option and adjust the level. 2. To adjust the green, enter the 「 G 」 option and adjust the level. 3. To adjust the blue, enter the 「 B 」 option and adjust the level.
IMAGE SETTING	
AUTO ADJUST	The auto adjustment function is used to optimize the 「 H-POSITION 」, 「 V-POSITION 」, 「 CLOCK 」, and 「 PHASE 」. [For VGA Input only]
ASPECT RATIO	When the aspect ratio of screen is distorted, you may make adjustments by using this function. 「 FULL 」 indicates full screen

	display, which does not ensure the image is shown as is or in initial scale. 「FIT」 indicates scaling by the proportion of original images, which may cause the screen showing black bands. [The availability of this function depends upon the selected model]
H-POSITION	Select the 「H-POSITION」 option to shift the screen image to the left or right. Enter the option and adjust the level. [For VGA only]
V-POSITION	Select the 「V-POSITION」 option to shift the screen image up or down. Enter the option and adjust the level. [For VGA only]
CLOCK	Select the 「CLOCK」 option to reduce the vertical flicker of characters on the screen. Enter the option and adjust the level. [For VGA only]
PHASE	Select the 「PHASE」 option to reduce the horizontal flicker of characters on the screen. Enter the option and adjust the level. [For VGA only]
SHARPNESS	Select the 「SHARPNESS」 option to adjust the sharpness of the display. Set the value from -2 to 2.
VIDEO MODE	Choose 「VIDEO MODE」 or 「PC MODE」 for video transmission. While using HDMI or HDMI to DVI ports for video transmission, the video will appear cut off slightly around the edge; choose 「PC MODE」 to view videos with complete image. (VIDEO MODE only functions for inputs from HDMI or DVI that supports HDCP video (YUV format))
RESPONSE TIME	Setup the display response time through the Response time function. Available settings are MINIMUM , INTERMEDIATE , and MAXIMUM . [This feature is limited to specific models only.]
OSD SETTING	
LANGUAGE	Select 「LANGUAGE」 option to change the language of the OSD. Enter the option and select a language. [Reference only, the OSD Language depends on the selected model]
H-POSITION	Select 「H-POSITION」 option to adjust the horizontal position of the OSD. Enter the option and adjust the level.
V-POSITION	Select 「V-POSITION」 option to adjust the vertical position of the OSD. Enter the option and adjust the level.
TRANSPARENCY	Select 「TRANSPARENCY」 option to adjust the transparency of

	the OSD. Enter the option and adjust the level.
OSD TIME-OUT	Select 「 OSD TIME-OUT 」 option to set the OSD time out from 10 to 100 seconds. Enter the option and adjust the level.
OSD COLOR	To choose the color combination of the OSD window, select 「 OSD COLOR 」 option under 「 OSD SETTING 」 menu, choose modes 1/2/3.
SYSTEM	
DDC/CI	Select the 「 DDC/CI 」 option to switch the function On or Off. [Dual input mode optional]
FACTORY RESET	Select the 「 FACTORY RESET 」 option to reset to the monitor's default setting. This will erase the current settings. Enter the option and select On or Off.
INFORMATION	Display Horizontal frequency/Vertical frequency/Resolution information.

PLUG AND PLAY

Plug & Play DDC2B Feature

This monitor is equipped with VESA DDC2B capabilities according to the VESA DDC STANDARD. It allows the monitor to inform the host system of its identity and, depending on the level of DDC used, communicate additional information about its display capabilities. The DDC2B is a bidirectional data channel based on the I²C protocol. The host can request EDID information over the DDC2B channel.

THIS MONITOR WILL APPEAR TO BE NON-FUNCTIONAL IF THERE IS NO VIDEO INPUT SIGNAL. IN ORDER FOR THIS MONITOR TO OPERATE PROPERLY, THERE MUST BE A VIDEO INPUT SIGNAL.

This monitor meets the Green monitor standards as set by the Video Electronics Standards Association (VESA) and/or the United States Environmental Protection Agency (EPA) and The Swedish Confederation Employees (NUTEK). This feature is designed to conserve electrical energy by reducing power consumption when there is no video-input signal present. When there is no video input signal this monitor, following a time-out period, will automatically switch to power saving mode. This reduces the monitor's internal power supply consumption. After the video input signal is restored, full power is restored and the display is automatically redrawn. The appearance is similar to a "Screen Saver" feature except the display is completely off. The display is restored by pressing a key on the keyboard, or clicking the mouse.

TECHNICAL SUPPORT (FAQ)

Q & A FOR GENERAL PROBLEMS

PROBLEM & QUESTION	POSSIBLE SOLUTION
Power LED is not on	<ul style="list-style-type: none"> *Check if the Power Switch is in the ON position. *Power Cord should be connected.
No Plug & Play	<ul style="list-style-type: none"> *Check if the PC system is Plug & Play compatible. *Check if the Video Card is Plug & Play compatible. *Check if any plug pins on the VGA or DVI connector are bent.
The display is too dark or too bright.	<ul style="list-style-type: none"> *Adjust the Contrast and Brightness Controls.
Picture bounces or a wave pattern is present in the picture	<ul style="list-style-type: none"> *Move electrical devices that may cause electrical interference.
The power LED is ON (orange) but there's no video or no picture.	<ul style="list-style-type: none"> *Computer Power Switch should be in the ON position. *Computer Video Card should be snugly seated in its slot. *Make sure monitor's video cable is properly connected to the computer. *Inspect monitor's video cable and make sure none of the pins are bent. *Make sure computer is operational by hitting the CAPS LOCK key on the keyboard while observing the CAPS LOCK LED. The LED should either turn ON or OFF after hitting the CAPS LOCK key.
Missing one of the primary colors (RED, GREEN, or BLUE)	<ul style="list-style-type: none"> *Inspect the monitor's video cable and make sure that none of the pins are bent.
Screen image is not centered or sized properly.	<ul style="list-style-type: none"> * Adjust pixel frequency CLOCK and PHASE or press hot-key (i Button).
Picture has color defects (White does not look white)	<ul style="list-style-type: none"> *Adjust RGB color or select color temperature.
The screen resolution needs to be adjusted	<ul style="list-style-type: none"> *Use win 2000/ME/XP Right click anywhere on desktop and select Properties>Settings>Screen Resolution. Use the silder to adjust the reslution and click Apply.
No sound is outputted from monitor's built-in speaker	<ul style="list-style-type: none"> *Make sure PC audio output cable is connected to screen's LINE IN port (or AUDIO IN port). *Make sure the sound volume adjustment can be clearly identified. *Make sure the System > Silence option in the monitor menu is on. *While transferring via HDMI port but no sound is outputted, it is recommended to select AUDIO

INPUT as a PC option, and make sure PC audio output cable is connected to monitor's LINE IN port(or AUDIO IN port). [For HDMI Input only]

Addendum related to Windows 7

When you encounter display problem under Windows 7, you need to do the following:

1. Make sure your PC computer (Hardware requirement) can support Windows 7.
2. Make sure your video card can run Windows 7.
3. If your video card can support Windows 7, need to install the latest Win 7 driver of your video card.

Suggest to do the following:

1. Install the latest Windows 7 video driver of your video card.
2. Try to use the recommended display resolution that is supported by the monitor.
3. If the recommended display resolution is not working, try the second recommended display resolution.

	1	2
35,56cm / 14" (16:9)	1366x768@60Hz	1366x768@50Hz
39,6cm / 15.6" (16:9)	1366x768@60Hz	1366x768@75Hz
40,64cm / 16" (16:9)	1366x768@60Hz	1366x768@50Hz
43,2cm / 17" (16:10)	1440x900@60Hz	1440x900@75Hz
47cm / 18.5" (16:9)	1366x768@60Hz	1366x768@75Hz
48,3cm / 19" (5:4)	1280x1024@60Hz	1280x1024@75Hz
48,3cm / 19" (16:10)	1440x900@60Hz	1440x900@75Hz
51cm / 20" (16:9)	1600x900@60Hz	1600x900@50Hz
56cm / 22" (16:10)	1680x1050@60Hz	1680x1050@50Hz
54,6cm / 21.5" (16:9)	1920x1080@60Hz	1920x1080@50Hz
58,4cm / 23" (16:9)		
60cm / 23.6" (16:9)		
62,5cm / 24.6 (16:9)	1920x1200@60Hz	1920x1200@50Hz
70cm / 27.5" (16:10)		

And if you still have display problem after doing the above procedure, please visit HANNS-G support and Service Website: <http://www.hannsg.com>

Windows is a registered trademark of Microsoft Corporation.

ERROR MESSAGE & POSSIBLE SOLUTIONS

▪ **CABLE NOT CONNECTED :**

1. Check that the signal-cable is properly connected, If the connector is loose, tighten the connector's screws.
2. Check the signal-cable's connection pins for damage.

▪ **INPUT NOT SUPPORT :**

Your computer has been set to unsuitable display mode, set the computer to display mode given in the following table.

FACTORY PRESET TIMING TABLE:

MODE	RESOLUTION	HORIZONTAL FREQUENCY (KHz)	VERTICAL FREQUENCY (Hz)
1	720x400 @70Hz	31.469	70.087
2	640x480 @60Hz	31.469	59.940
3	640x480 @67Hz	35.000	66.667
4	640x480 @72Hz	37.861	72.809
5	640x480 @75Hz	37.500	75.000
6	800x600 @56Hz	35.156	56.250
7	800x600 @60Hz	37.879	60.317
8	800x600 @72Hz	48.077	72.188
9	800x600 @75Hz	46.875	75.000
10	832x624 @75Hz	49.725	75.000
11	1024x768 @60Hz	48.363	60.004
12	1024x768 @70Hz	56.476	70.069
13	1024x768 @75Hz	60.023	75.029
14	1152x870 @75Hz	68.681	75.062
15	1152x864 @75Hz	67.500	75.000
16	1280x960 @60Hz	60.000	60.000
17	1280x1024 @60Hz	63.981	60.020
18	1280x1024 @75Hz	79.976	75.025
19	1440x900 @60Hz	64.981	60.050
20	1920x1080 @60Hz	66.587	59.934
21	1600x1200 @60Hz	75.000	60.000
22	1400 x 1050 @ 60Hz	64.744	59.948
23	1680 x 1050 @ 60Hz	65.290	59.954

(Video mode)

MODE	RESOLUTION
1	640×480p @60Hz
2	720×480p @60Hz
3	720×576p @50Hz
4	1280×720p @60Hz
5	1920×1080i @50Hz
6	1920×1080i @60Hz
7	1920×1080p @50Hz
8	1920×1080p @60Hz

** We ensure that the monitor can be lighted under interlace signal mode, but we can not guarantee the image quality.

APPENDIX

SPECIFICATIONS

LCD Panel	Driving system	TFT Color LCD
	Size	54,6cm / 21.5" Diagonal
	Pixel pitch	0.248mm(H) x 0.248mm(V)
Video	H-Frequency	24KHz – 85KHz
	V-Frequency	56– 75Hz
Display Colors		16.7M Colors
Max. Resolution		1920 x 1080 @60Hz
Plug & Play		VESA DDC2B™
Power consumption	ON Mode	28 W (Typical)
	Power Saving Mode	≤1W
	OFF Mode	≤0.5 W
Input Terminal		VGA DVI (optional)
Maximum Screen Size		Hor. : 476.64 mm Ver. : 268.11 mm
Power Source		100~240VAC,50±3Hz,60±3Hz
Environmental Considerations		Operating Temp: 0° to 40°C Storage Temp.: -20° to 60°C Operating Humidity: 5% to 90%
Dimensions		512.6(W) x 367.7(H) x 174.3(D) mm 20.2 "(W)×14.5 "(H)× 6.9 "(D)
Weight (NW)		3.1 kg

*** The above specification is subject to actual product specification and is subject to change without prior notice.

NOTES:

The Maximum Resolution will depends on the display card supporting. Related issue can refer to www.hannsg.com FAQ section.