

ÖKO-LAVAMAT 60300

The environmentally friendly washing machine

Instruction book



Dear customer,

Please read these user instructions carefully.

Above all, observe the "Safety" section in the first pages. Keep these user instructions in a safe place for future reference. Please pass them along to future owners of the appliance.



Important information concerning your safety and proper functioning of the appliance is highlighted with the warning triangle or the signal words (**Warning!**, **Caution!**, **Attention!**). Please observe carefully.



1. This symbol guides you step by step when operating the appliance.

2. ...



Next to this symbol you receive additional information and practical tips on using the appliance.



Tips and information about the economical and environmentally friendly use of the machine are marked with the clover.

These user instructions include tips for the correction of possible malfunctions by the user. See the section "What to do when...".

Our customer service department is at your disposal should technical problems occur. See also the "Service" section.

Printed on paper manufactured with environmentally sound processes.
He who thinks ecologically acts accordingly ...

CONTENTS

Operating instructions	6
Safety	6
Disposal	8
Environmental protection tips	8
Description of the Appliance	9
Front View	9
Drawer for Detergent and Conditioner	9
Control Panel	10
Program Selector	10
Temperature Selector	11
Washing Type Button	11
Ⓞ (ON/OFF) Button	12
Consumption Data and Time Required	12
Before Washing for the First Time	13
Prepare washing cycle	14
Sort washing and prepare	14
Washing Types and Care Symbols	15
Detergent and conditioner	16
Which detergent and conditioner?	16
How much detergent and conditioner?	16
Using Water Softener	16
Performing A Wash	17
Brief Instructions	17
Loading the Washing	18
Adding Detergent/Conditioner	18
Setting the Washing Program	19
Starting the Washing Program	19
Changing the Spin Speed/Selecting Rinse Hold	20
During the Washing Program	20
Wash Complete/Removing the Washing	21

Program Tables	22
Washing	22
Separate Soaking	24
Separate Conditioning/Starching/Treatment	24
Separate Rinsing	24
Separate Spinning	24
Cleaning and Caring	25
Control panel	25
Detergent drawer	25
Washing drum	26
Fill-in door	26
What to do when...	27
Trouble Shooting	27
If the washing results are not satisfactory	30
Perform emergency drain	31
Clean the circulating pump	32
Additional Rinse/Water Cooling	33
Installation and Connection Instructions	34
Installation Safety Precautions	34
Dimensions of the appliance	35
Front and Side Views	35
Rear View	35
Installation of the appliance	36
Transporting the appliance	36
Remove transportation protection	37
Prepare the installation place	38
Installation on a concrete base	38
Installation on vibrating floors	38
Levelling on uneven floors	39

Power supply	39
Water connection	40
Permissible water pressure	40
Water feed	41
Water drain-off	42
Delivery head above 1 m	42
Technical data	43
Service Departments	44
Guarantee Conditions	45
Index	46
Service	47

OPERATING INSTRUCTIONS

Safety

The safety standards of AEG electric appliances are in keeping with the recognised rules of technology and the law governing the safety of appliances. Nevertheless as a manufacturer we are committed to familiarise you with the following safety instructions:

Prior to initial start-up

- Observe the "**Installation and Connection Instructions**" below in these user instructions.
- If the appliance is delivered during the winter and temperatures are below freezing, allow the appliance to stand at room temperature for 24 hours before operation

Intended use

- The washing machine is intended exclusively for the washing of normal household washing in the home. If the appliance is used for purposes other than those intended, or if it is improperly operated, the manufacturer can assume no liability for damages which may occur.
- Additions or modifications to the washing machine are strictly forbidden due to safety reasons.
- Use only those detergents which are suitable for the washing machine. Observe instructions provided by the detergent manufacturer.
- Laundry to be washed may not contain any flammable solvents. This must also be taken into consideration when washing pre-washed laundry.
- Do not use the washing machine for dry-cleaning.
- Dyes and bleaches may only be used in the washing machine if such use has been expressly endorsed by the manufacturer of these products. We can assume no liability for damages which may occur.
- Use tap water only. Rain water and industrial water may only be used if they fulfil requirements in accordance with DIN1986 and DIN1988.
- Damage due to frost is not covered by the guarantee! If the washing machine is located in a room in which below freezing temperatures might occur, emergency draining must be carried out if danger of freezing occurs (see "Emergency Draining"). Furthermore, the inlet hose must be disconnected from the tap and laid on the floor.

Safety of children

- Packaging materials (e.g. sheet and Styrofoam) can be dangerous for children. Danger of asphyxiation! Keep packaging materials at a safe distance from children.
- Children are often unable to recognise the dangers involved with electrical appliances. Provide for proper supervision during operation, and do not allow children to play with the washing machine – the danger exists that a child might lock itself into the appliance.
- Make certain that children or small animals do not climb into the drum of the washing machine.
- If the washing machine needs to be disposed of, remove the mains plug, destroy the door lock, cut off the electrical cable and dispose of the plug and remaining cable separately. In this way children are prevented from locking themselves in and are not exposed life threatening danger.

General Safety

- Repairs to the washing machine may only be carried out by trained personnel. Improper repairs can give rise to significant hazards. If repairs are required, contact customer service or your dealer.
- Never use the washing machine if the mains cable is damaged or the control panel, the work surface, or the plinth are damaged to such an extent that components inside the machine are openly accessible.
- Switch off the washing machine before cleaning, maintenance and servicing. In addition, unplug from the mains or – in the case of permanent connection – pull the circuit breaker, or completely remove screw type fuses.
- Never remove the mains plug by pulling on the cable. Always grip the plug.
- Multi-way plugs / connectors and extension cables must not be used!
- Do not clean the washing machine with a jet of water. There is a risk of electric shock!
- When high temperature washing programs are selected, the glass in the door becomes hot. Do not touch!
- Leave the water in the machine to cool down before performing an emergency drain or cleaning the circulation pump.
- Small animals may gnaw at electrical power cables and water hoses. There is a risk of electric shock and damage from water leaks! Keep small animals away from the washing machine.



Disposal

Dispose of the packaging!

Dispose of washing machine packaging materials properly. All packaging materials are environmentally sound and can be safely disposed of, or burned in a refuse incineration plant.

The plastic parts can be reused:

- The external plastic cover and the bags inside are made of polyethylene (marking >PE<).
- The padding is made of CFC free expanded polystyrene (marking >PS<).

Corrugated components are made from recycled paper and should be disposed of at a paper recycling station.

Dispose of your old appliance!

If, at some point in time, the service life of the appliance has expired, please take it to your nearest recycling centre, or to your appliance dealer, who will accept the old appliance for a minimal fee.



Environmental protection tips

- No pre-wash is required for normally soiled washing. This saves you detergent, water and time (and is good for the environment!).
- If the indicated load capacities are taken full advantage of, the washing machine is especially efficient.
- For small loads, use only one half to one third of the recommended detergent quantity.
- Stains and soiling confined to given areas can be removed by means of appropriate pre-treatment. You can then wash at lower temperatures.
- Wash lightly to medium soiled cottons with the energy saving program.
- Softeners are often not required. Try it! If you use a dryer, your washing will be soft and fluffy, even without softeners.
- A water softener should be used for water within a hardness range of mid to high (as of hardness level II, see "Detergents and Conditioners"). Detergent can then always be dosed for water hardness level I (= soft).

Description of the Appliance

Front View

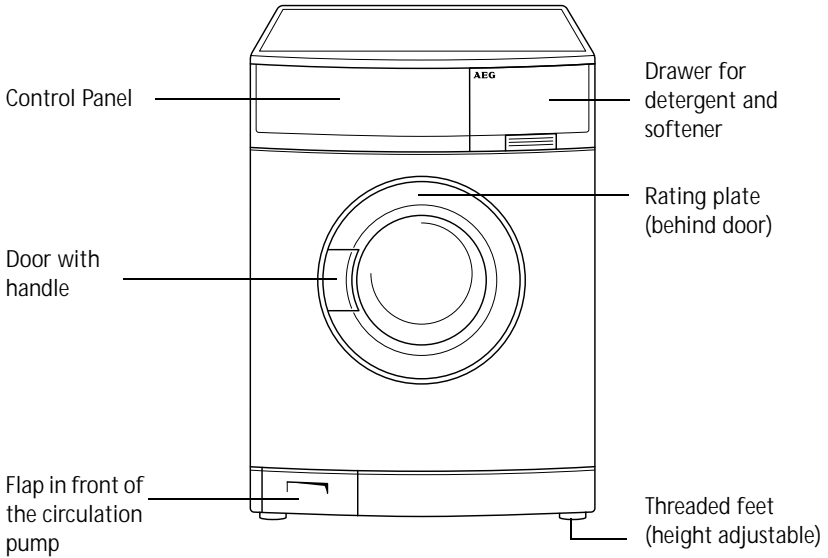

Drawer for Detergent and Conditioner

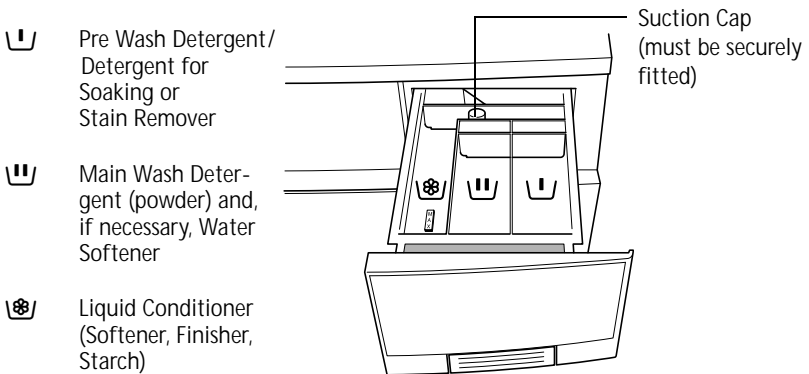

Control Panel

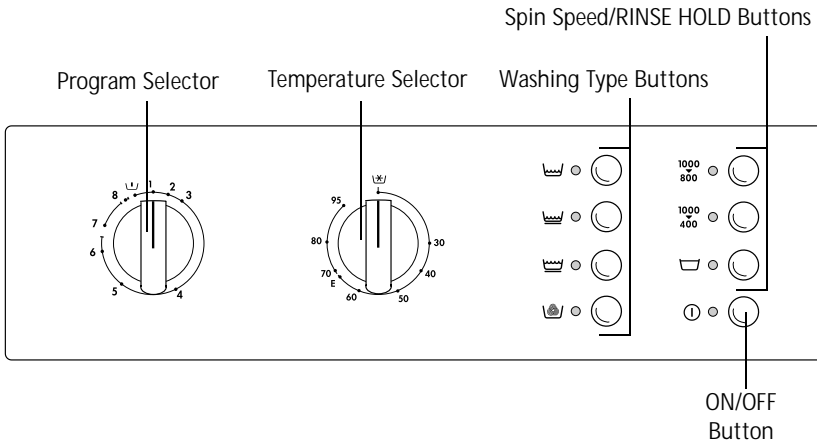

Program Selector

You define the type of wash using the program selector.

Attention! Program selector may only be rotated clockwise!

The various positions have the following effect:

Position (PRE WASH)

Cold pre wash prior to the main wash, the main wash follows automatically. (Not for washing type /WOOLLENS.)

Position 1 (STAIN)

For treating heavily soiled or stained washing. Lengthened main wash, stain remover is washed in at the optimal point in the program cycle. (Not for washing type /WOOLLENS.)

Position 2 (MAIN WASH)

Main wash for normally soiled washing.

Position 3 (QUICK WASH)

Shortened main wash for lightly soiled washing.

Position 4 (RINSE)

Separate rinse, e.g. for rinsing hand washed fabrics (spinning in accordance with the selected washing type or rinse hold).

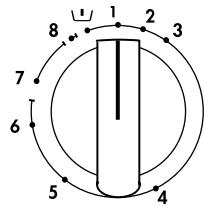



Rinse hold (☐) means: the washing is left in the last rinse water, it is not spun.

Position 5 (CONDITIONER)

Separate conditioning, separate starching, separate treatment of wet cotton/linen or easy-care washing (1 rinse, liquid conditioner is washed in from the ☒ compartment, spinning in accordance with the selected washing type or rinse hold).

Position 6 (SPIN)

Spinning after a rinse hold or separate spinning of hand washed fabrics in accordance with the selected washing type.

Position 7 (SOAKING)

Separate soaking (temperature automatically limited to a maximum of 40°C), the washing is left in the water at the end of the program (Not for washing type ☒/WOOLLENS).



After soaking the required main wash must be set, the program does automatically continue.

Position 8 (PUMP OUT)

Pumps out the water after a rinse hold (without spinning).

Temperature Selector

You can set the following temperature levels on the temperature selector:

☒ (COLD), 30, 40, 50, 60, E, 70, 80, 95



The E setting (Energy Saving Program) is suitable for lightly to normally soiled cottons; temperature reduced to approx. 67°C.

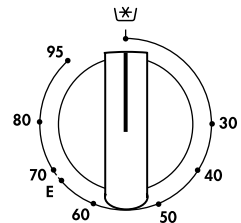

Washing Type Button

The program sequence (e.g. max. possible temperature, water level, drum movement, number of rinses, spin speed) is altered to suit the type of washing using the washing type buttons.

☒ (COTTONS/LINEN)

For cottons and linen.

☒ (EASY-CARES)

For easy-care washing (mixed fabrics). Temperature automatically limited to a maximum of 60°C.

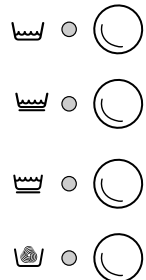

 **(DELICATES)**

For delicate washing (temperature automatically limited to a maximum of 40°C).

 **(WOOLLENS)**

For machine washable woollens and particularly delicate fabrics (temperature automatically limited to a maximum of 40°C).





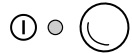

 **(ON/OFF) Button**

This button is used to switch on the washing machine and start the selected program, or to switch off the washing machine.



Consumption Data and Time Required

The values given in the following table for selected programs were calculated under standard conditions. They provide a useful guide for operation in the home.

Program Selector	Temperature Selector	Washing Type Button	Load in kg	Water in Litres	Energy in kWh	Time in minutes
Position 2 (MAIN WASH)	95	 (COTTONS/ LINEN)	5	54	1.70	143
	60 ¹⁾	 (COTTONS/ LINEN)	5	54	1.05	129
	40	 (COTTONS/ LINEN)	5	54	0.63	129
	40	 (EASY CARES)	2.5	50	0.43	93
	30	 (DELICATES)	2.5	52	0.43	83
	30	 (WOOLLENS)	2	51	0.32	58

1) **Note:** program setting for testing in accordance with EN 60 456

Before Washing for the First Time

1. Pull the detergent drawer out from the control panel a little.
2. Pour around 1 litre of water into the washing machine via the detergent drawer. This will ensure when the washing machine is started that the water container is closed and that the ECO valve can function correctly.
3. Perform a washing cycle without any washing, position 2 (MAIN WASH) 95, with half the normal dose of detergent.
This serves to remove residues resulting from production of the appliance from the drum and the water container.

Prepare washing cycle

Sort washing and prepare

- Sort washing according to care symbol and type (see "Washing types and care symbols").
- Empty all pockets.
- Remove metal objects (paper clips, safety pins etc.).
- In order to prevent bunching up of washing and damage to washing, close zippers, button up duvets and pillow cases, and tie up loose ends from, for example, aprons.
- Turn articles with double layered textiles inside out (sleeping bags, anoraks etc.).
- Coloured, knitted fabrics, as well as wool and textiles with appliqués should be turned inside out.
- Place small and delicate articles (baby booties, stockings, bras etc.) into a washing net, a pillow case with zipper, or in large socks before washing.
- Treat net curtains particularly carefully. Remove metal curtain rail rollers or burred plastic rollers, or wrap these in a net or bag. We cannot accept any liability for damage.
- Do not wash coloured and white washing together. White washing will otherwise turn grey.
- New, coloured washing often contains excessive dye. Wash these items separately the first time.
- Mix small and large articles of washing! This improves washing efficiency, and the washing is more favourably distributed during the spin cycle.
- Fluff washing before placing into the washing machine.
- Do not place folded washing into the drum.
- Observe tips for proper care such as "wash separately" and "wash separately several times"!

Washing Types and Care Symbols

Care symbols assist in the selection of the correct washing program. Washing should be sorted according to type and care symbol. The temperatures indicated in the care symbols are maximum temperatures.

Cottons

Cotton and linen fabrics with this care symbol are resistant to the mechanical action of the washing machine and high temperatures. The  (COTTONS/LINEN) program is suitable for this type of washing.

Linen

Cotton and linen fabrics with this care symbol are resistant to the mechanical action of the washing machine. The  (COTTONS/LINEN) program is suitable for this type of washing.

Easy-care washing



Fabrics such as treated cottons, cotton mixtures and synthetics with this care symbol need careful handling. The  (EASY-CARES) program is suitable for this type of washing.

Delicates

Fabrics such as those with layered fibres, micro-fibres, as well as synthetics and net curtains with this care symbol need particularly careful handling. The  (DELICATES) program is suitable for this type of washing.

Woollens and particularly delicate washing

Fabrics such as woollens, wool mixtures and silk with this care symbol are particularly delicate in respect of the mechanical action of the washing machine. The  (WOOLLENS) program is suitable for this type of fabrics.

Important! Fabrics with the  (hand washing) or  (do not wash!) care symbols must not be washed in the washing machine!

Detergent and conditioner

Which detergent and conditioner?

Use only detergents and conditioners which are suitable for use in washing machines. Always observe the manufacturer's instructions.

How much detergent and conditioner?

The required quantity depends upon:

- the amount of washing



If the detergent manufacturer does not include dosing instructions for reduced loads, use one third less for half loads and only half of the full load detergent quantity for very small loads.

- extent of soiling of the washing
- hardness of tap water

Observe instructions for use and dosing provided by the detergent and conditioner manufacturer.

Using Water Softener

In the case of medium to very hard water (from hardness band II) water softener should be used. Observe the manufacturer's instructions! Then always use detergent dosing for hardness band I (= soft). Information on the hardness of the water in your area is provided by your local water board.

Information on Water Hardness

Hardness Band	Water hardness in °dH (German hardness scale)	Water hardness in mmol/l (millimol per litre)
I – soft	0 – 7	to 1.3
II – medium-hard	7 – 14	1.3 – 2.5
III – hard	14 – 21	2.5 – 3.8
IV – very hard	greater than 21	greater than 3.8

Performing A Wash

Brief Instructions

A wash is performed in the following steps:

1. Open the door, load the washing.
2. Close the door.
3. Add detergent/conditioner.
4. Set the correct washing program:
 - Set the program on the program selector;
 - Set the temperature on the temperature selector;
 - Select the washing type using the washing type buttons.
5. Press the  (ON/OFF) button.
The washing machine is switched on. The washing program starts.
6. If necessary, change the spin speed or select rinse hold.
You can alter this setting and the temperature at any time during the wash.

At the end of the washing program:

The washing program is finished when the  (ON/OFF) button indicator extinguishes.

Important! If the washing cycle ends with rinse hold, perform either PUMP OUT (position 8) or SPIN (position 6) before opening the door.

7. Open the door, remove the washing.
8. Press the  (ON/OFF) button.
The washing machine is switched off.

Loading the Washing

i For maximum loads see the "Program Tables". For notes on the correct preparation of the washing, see "Washing Types and Care Symbols".

- ☞** 1. Sort the washing by type and prepare.
- 2. Open the door: pull the handle on the door.
- 3. Load the washing.

Important! Do not trap any washing when closing the door! The fabrics and the machine could be damaged!

- 4. Close the door firmly.

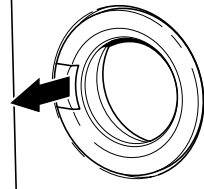



Adding Detergent/Conditioner

i For information on detergents and conditioners see "Detergents and Conditioners".

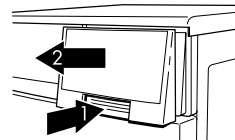
- ☞** 1. Open the drawer: press in the flap on the drawer so as to be able to grasp the handle (1), pull out the drawer (2).
- 2. Add detergent/conditioner.



 Pre wash detergent/detergent for soaking or stain remover (only for /PRE WASH, position 7/ SOAKING or position 8/STAIN programs.)

 Powdered main wash detergent and water softener, if necessary. (If you use water softener, add the water softener on top of the main wash detergent.)

 Liquid conditioner (softener, finisher, starch, other treatments)

Important! Do not fill the compartment beyond the MAX mark. Thick liquid detergents can be diluted up to the MAX mark, powdered starch can be dissolved.

- 3. Push the drawer fully home.

When using liquid detergents:

Add liquid detergent using the dosing containers provided by the detergent manufacturer. Observe the instructions on detergent pack.

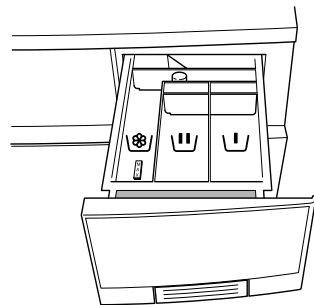

Setting the Washing Program

i For suitable programs and the right temperature for the relevant type of washing, see "Program Tables".

Important! Only turn the program selector clockwise!

 1. Set the program selector to the desired washing program.

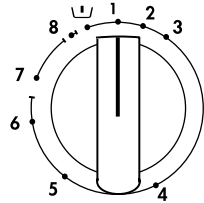

2. Set the temperature selector to the required temperature.

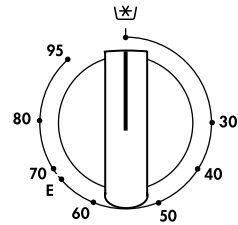

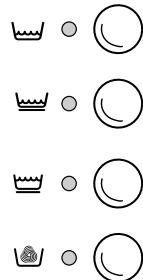

3. Select the washing type.

- The display for the chosen washing type illuminates.
- To change the selection, press another button.



Starting the Washing Program

 1. Check whether the water tap is open.

2. Switch on the washing machine: Press the  (ON/OFF) button.

- The washing program starts.
- The door is locked at the latest 15 seconds after program start. The  (ON/OFF) indicator illuminates.

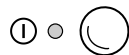

Changing the Spin Speed/Selecting Rinse Hold

 If desired, reduce the spin speed for the final spin or select rinse hold:

- Press the button for the required spin speed
- press the  (RINSE HOLD) button.

The indicator for the required spin speed (or ) illuminates.

If  (RINSE HOLD) is selected, the washing is left in the last rinse water, it is not spun.

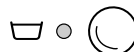
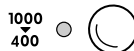
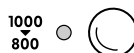

 If you do not reduce the spin speed, the final spin for all washing programs is automatically performed at 1000 revolutions per minute. The speed for the intermediate spin is dependent on the program selected and cannot be changed.

During the Washing Program

Program Progress Indicator

The program selector serves as a program progress indicator by rotating in a clockwise direction to the end of the program.

 In the case of the STAIN (position 1), MAIN WASH (position 2) and QUICK WASH (position 3) programs, immediately after program start the program selector moves to a position directly behind QUICK WASH (position 3). The program selector then indicates the progress of the program as usual.



Changing Settings

During the washing program you can:

- Change the spin speed
- Select  (RINSE HOLD)
- Change the temperature setting

Other settings cannot be altered.

Stopping the Program Early

-  1. Press the  (ON/OFF) button.
2. Turn the program selector clockwise to position 8 (PUMP OUT).
3. Press the  (ON/OFF) button again.
The water is pumped out.

Wash Complete/Removing the Washing



The washing program is finished when the  (ON/OFF) button indicator lamp extinguishes.

After a Rinse Hold:

After a rinse hold the water must be pumped out first, or the washing spun:

-  Either press one of the buttons to change the final spin speed/ (the indicator lamp for the required spin speed illuminates)
- or
- turn the program selector clockwise to position 6 (SPIN), (washing is spun in accordance with the program just completed),
- or
- turn the program selector clockwise to position 8 (PUMP OUT) (water is pumped out).

Once the Program is Finished:













-  1. Open the door.
 - 2. Remove the washing.
- Important!** The washing machine still needs to be switched off.
- 3. Press the  (ON/OFF) button.
 - 4. Close the water tap.
 - 5. Pull out the detergent drawer a little so that it can dry out. Leave the door ajar so that air can circulate in the washing machine.





Important! If the washing machine is not to be used for a long period: close the tap and isolate the washing machine from the mains.

Program Tables

Washing

Not all possible settings are listed in the following, but only those that are useful and meaningful in everyday use.

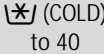
Washing Type, Care Symbol	Max. Load (weight dry) ¹⁾	Program Selector	Temperature Selector	Washing Type Button
Cottons 	5kg	Position 2 (MAIN WASH)	70 to 95	 (COTTONS/ LINEN)
		Position  (PRE WASH)		
		Position 1 (STAIN)		
		Position 3 (QUICK WASH)		
Energy Saving Program: Cottons 	5kg	Position 2 (MAIN WASH)	E	 (COTTONS/ LINEN)
		Position  (PRE-WASH)		
Linen  	5kg	Position 2 (MAIN WASH)	30 to 60	 (COTTONS/ LINEN)
		Position  (PRE-WASH)		
		Position 1 (STAIN)		
		Position 3 (QUICK WASH)		
Easy-Cares   	2.5kg	Position 2 (MAIN WASH)	30 to 60	 (EASY CARES)
		Position  (PRE WASH)		
		Position 1 (STAIN)		
		Position 3 (QUICK WASH)		

Washing Type, Care Symbol	Max. Load (weight dry) ¹⁾	Program Selector	Temperature Selector	Washing Type Button
Delicates 	2.5kg (or 15-20m ² net curtains)	Position 2 (MAIN WASH)	 (COLD) to 40	 (DELICATES)
		Position  (PRE-WASH)		
		Position 1 (STAIN)		
		Position 3 (QUICK WASH)		
Woollens ²⁾  	2kg	Position 2 (MAIN WASH)	 (COLD) to 40	 (WOOLLENS)
		Position 3 (QUICK WASH)		





1) A 10-litre bucket contains about 2.5kg of dry washing (cotton).

2) Only wash woollen garments with the woolmark in the machine if they are also marked with "does not produce fluff", "non-fluffing" or "washing machine-safe".





Separate Soaking

Type of Washing	Max. Load (weight dry)	Program Selector	Temperature Selector	Washing Type Button
Cottons/Linen	5 kg	Position 7 (SOAKING)	 (COLD) to 40	 (COTTONS/LINEN)
Easy-Cares	2.5 kg			 (EASY-CARES)
Delicates	2.5 kg			 (DELICATES)





Separate Conditioning/Starching/Treatment

Type of Washing	Max. Load (weight dry)	Program Selector	Washing Type Button
Cottons/Linen	5 kg	Position 5 (CONDITIONER)	 (COTTONS/LINEN)
Easy-Cares	2.5 kg		 (EASY-CARES)
Delicates	2.5 kg		 (DELICATES)
Woolens	2 kg		 (WOOLLENS)

Separate Rinsing

Type of Washing	Max. Load (weight dry)	Program Selector	Washing Type Button
Cottons/Linen	5 kg	Position 4 (RINSE)	 (COTTONS/LINEN)
Easy-Cares	2.5 kg		 (EASY-CARES)
Delicates	2.5 kg		 (DELICATES)
Woolens	2 kg		 (WOOLLENS)

Separate Spinning

Type of Washing	Max. Load (weight dry)	Program Selector	Washing Type Button
Cottons/Linen	5 kg	Position 6 (SPIN)	 (COTTONS/LINEN)
Easy-Cares	2.5 kg		 (EASY-CARES)
Delicates	2.5 kg		 (DELICATES)
Woolens	2 kg		 (WOOLLENS)

Cleaning and Caring

Control panel

Attention! Do not use furniture care products or aggressive cleansers for cleaning control panels and control elements.

- ☞ Wipe control panels with a moist cloth. Use warm water.

Detergent drawer

The detergent drawer should be cleaned from time to time.

- ☞ 1. Pull the detergent drawer out as far as it will go.
- 2. Remove the detergent drawer by pulling sharply.
- 3. Remove siphon cap.

- 4. Clean the siphon cap under running water.

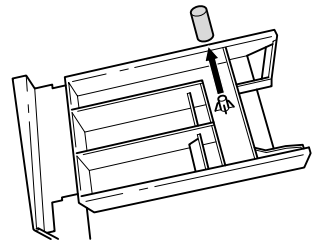

- 5. Clean compartments with warm water from the rear. For best results use a bottle brush.

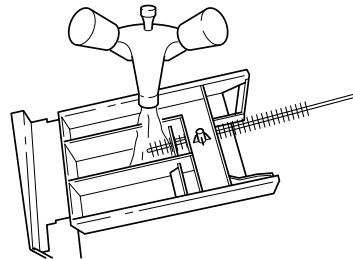

- 6. Push the siphon cap all the way on so that it is securely seated.
- 7. Clean the entire compartment area of the washing machine with a brush.

- 8. Set the detergent drawer into the guide tracks and push in.

Washing drum

The washing drum is made of rust-free stainless steel. Rusty objects in the washing drum may lead to rust deposits on the drum.

Attention! Do not clean the stainless steel drum with acid containing decalcifying agents, abrasives containing chlorine or iron, or steel wool. Appropriate cleansers are available from our customer service department.

 Remove rust deposits at the drum with a stainless steel cleanser.

Fill-in door

 Check on a regular basis to see if deposits or foreign objects are present in or at the rubber sleeve behind the door, and remove.

What to do when...



The somewhat different, in comparison to older washing machines, whistling noise during spinning is due to the modern drive system.



A rattling sound on startup – in particular when using for the first time – is caused by the circulation pump and is due to the design.













Trouble Shooting

In the case of a malfunction try to solve the problem with the aid of the notes given here. If you call in customer service to resolve one of the malfunctions listed here, or rectify an error made in the operation of the appliance, the customer service engineer's visit is not free of charge, even during the period of guarantee.

Malfunction	Possible Cause	Remedy
Washing machine does not work.	Mains plug is not plugged in.	Insert mains plug.
	House fuse is defective.	Replace fuse or switch on trip.
The machine does not take in water.	Door is not closed properly.	Close door, lock must engage audibly
	Tap is closed.	Press the Ⓢ (ON/OFF) button; Open tap; Reselect program; Press the Ⓢ (ON/OFF) button again.
	Sieve in the threaded fitting on the water inlet hose is blocked.	Unscrew the hose from the tap, remove the sieve and clean under running water

Malfunction	Possible Cause	Remedy
Washing machine vibrates during operation or is unstable.	The height adjustable threaded feet are not correctly adjusted.	Adjust threaded feet as per the installation instructions.
	There is only very little washing in the drum (e.g. only a towelling dressing gown).	Function is not impaired.
	Water cannot be completely pumped out because the drain hose is kinked or the circulation pump is blocked.	Check the drain hose and if necessary remove any kink or clean the circulation pump and remove any foreign bodies from the pump housing.
Excessive foaming during the main wash.	Probably too much detergent was used	Dose detergent exactly in accordance with the manufacturer's instructions.
Water runs out from under the washing machine.	Threaded fitting on the water inlet hose is leaking.	Tighten the water inlet hose
	Drain hose is leaking.	Check drain hose and if necessary replace.
	Circulation pump cover is not closed properly.	Close cover properly.
	Washing is trapped in the door.	Stop program, remove washing from the door, start a new program.
Softener is not washed in,  compartment for conditioner is full with water.	Suction cap in the compartment for conditioner is not correctly positioned or is blocked.	Clean detergent drawer, place suction cap firmly in position.
Appliance does not spin, water in the drum.	 (RINSE HOLD) selected.	Deselect  (RINSE HOLD).
	Soaking program is finished.	Pump out the water and set the main wash cycle as desired.

Malfunction	Possible Cause	Remedy
Washing is not spun properly, water is still visible in the drum.	Drain hose is kinked.	Remove kink.
	Maximum pumping height (drain height 1 m above the floor on which the machine is standing) exceeded.	Please contact customer service who have a retrofit kit for pumping to heights of greater than 1 m.
	Circulation pump is blocked.	Switch off the machine and unplug from the mains, clean the circulation pump.
	In the case of siphon connection: siphon is blocked.	Clean siphon.
It is not possible to open the door.	Program is not yet finished;  (ON/OFF) indicator lamp is illuminated.	Wait until the  (ON/OFF) indicator lamp extinguishes.
Rinse water is cloudy.	This is probably due to using a detergent with a high silicate content.	No negative impact on the rinsing results, possibly use liquid detergent.
Remnants of detergent are building up in the detergent drawer.	Tap is not fully open.	Open tap fully.
	The sieve in the threaded fitting on the water inlet hose at the tap is blocked.	Clean sieve.
	Sieve on threaded fitting for the water inlet hose on the machine is blocked.	Clean sieve.
Program selector skips  (PRE WASH).	 (PRE WASH) combined with  (WOOLLENS).	 (PRE WASH) cannot be combined with  (WOOLLENS).
Program selector remains stationary at position 7 (SOAKING).	Position 7 (SOAKING) is combined with  (WOOLLENS).	Position 7 (SOAKING) cannot be combined with  (WOOLLENS).
Stain remover is not washed in.	Position 1 (STAIN) is combined with  (WOOLLENS).	Position 1 (STAIN) cannot be combined with  (WOOLLENS).

If the washing results are not satisfactory

If the washing is grey and there are calcium deposits in the drum

- Too little detergent was used.
- The wrong detergent was used.
- Special soiling was not pre-treated.
- Program or temperature not set correctly.
- When using component detergents, the individual components were not used in the correct proportions.

If there are still gray stains on the washing

- Washing soiled with ointments, grease or oils was washed with too little detergent.
- Too lower temperature was used for washing.
- A common cause is that softener – particularly that in concentrated form – has got onto the washing. Wash out any such spots as quickly as possible and use that particular softener carefully.

If at the end of the last rinse foam is still visible

- Modern detergents can cause foam also in the last rinse. The washing is however sufficiently rinsed.

If there are white remnants on the washing

- This is an insoluble material contained in modern detergents. This is not the result of unsatisfactory rinsing. Shake or brush the washing. Perhaps you should turn the washing inside out before washing in future. Reconsider choice of detergent, possibly use liquid detergent.

Perform emergency drain

- If the washing machine no longer pumps out the water then an emergency drain must be performed.
- If the washing machine is located in a room in which below freezing temperatures might occur, emergency draining must be carried out if danger of freezing occurs.
Furthermore, the inlet hose must be disconnected from the tap and laid on the floor.



Warning! Switch the washing machine off and pull the mains plug prior to emergency draining.

Attention! The water which runs out of the emergency draining hose can be hot. There is a danger of scolding! Before an emergency drain first allow the water to cool down!

1. Have a flat container on hand to catch the water running out.
2. Open the flap on the left of the pedestal cover downwards and remove.

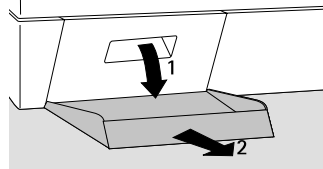

3. Remove the emergency drain hose from the bracket.

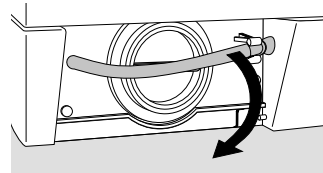

4. Pull the emergency drain hose out a little.

5. Place the container under the hose.

6. Undo and remove the plug in the end of the emergency drain hose by turning it in an anti-clockwise direction.

The wash-water runs out. Depending upon the amount of water, it may be necessary to empty the container several times. Temporarily close the emergency drain hose with the plug to this end.

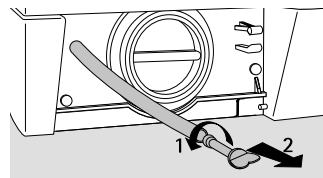

When the water is completely drained:

7. Press the end stop firmly back into the emergency drain hose.
8. Push the emergency drain hose back in a little and allow it to snap into the mounting.
9. Put on the flap and close.



The ECO valve does not function when the machine has been fully emptied. Therefore add approx. 1 liter of water before the next wash (pour in through the detergent drawer).

Clean the circulating pump



Warning! Switch off the washing machine and pull the mains plug before cleaning the circulation pump!



1. First perform emergency draining (see above: "Perform Emergency Drain").
2. Lay a cloth on the floor in front of the circulation pump cover. Some water may run out.
3. Unscrew the circulation pump cover in an anti-clockwise direction and remove.
4. Remove foreign body from the pump housing.

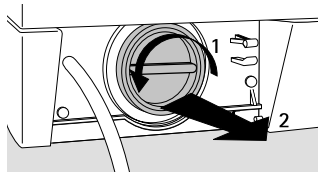

5. Check whether it is possible to turn the pump impeller. (Jerky pump movement is normal.) If it is not possible to turn the impeller, contact customer service.

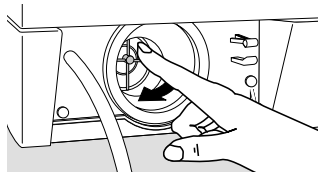

6. Replace cover (insert stud on the cover into the guide slot) and tighten in a clockwise direction.
7. Close emergency drain hose, push in and fix in place.
8. Close the flap.

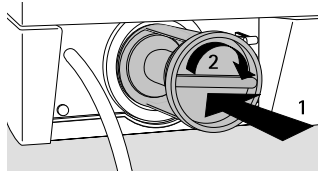

Additional Rinse/Water Cooling

The washing machine is set up for extremely low water consumption.

- For people who suffer from an allergy to detergents, it can be useful to rinse with more water (additional rinse).
- It may be necessary to cool the water before it is pumped out in order to prevent damage to plastic waste pipes (water cooling).

You can activate these functions using the More Water Switch.





The program duration and water consumption are increased by water cooling and/or the additional rinse.

Position "1": Water Cooling

At the end of the main wash, the water is cooled (by adding cold water) prior to pumping out.

This setting is only effective for  (COTTONS/LINEN) with a temperature above 40 °C.

Position "2": Water Cooling and Additional Rinse

The water is cooled as in position 1, and an additional rinse is also performed during the  (COTTONS/LINEN),  (EASY-CARES) and  (DELICATES) programs.



As supplied the More Water Switch is set to position 0.

Make the Adjustment:



1. Pull out the detergent drawer until the More Water Switch is accessible in the frame on the left.
2. Set the More Water Switch to "1" (water cooling) or "2" (water cooling and additional rinse).

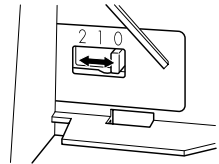

INSTALLATION AND CONNECTION INSTRUCTIONS

Installation Safety Precautions

- Do not tip the washing machine over the front or the left side (seen from the front). Electrical components could become wet!
- Check the washing machine for transport damages. You should never connect a damaged appliance. In the event of a damage consult your dealer.
- Make certain that all shipping braces have been removed and that the splash guard is attached to the appliance, see "Shipping Brace Removal". Otherwise damage may occur to the machine or close by furniture during the spin cycle.
- The plug may only be inserted into a properly installed earthing contact safety socket. Extension cables, octopus plugs or adapters may not be used.
- For permanent connection a current interruption device must be provided for in the electrical circuit (fuse, circuit breaker, ground fault circuit interrupter or the like) with a contact opening of at least 3 mm which allows for disconnection of the appliance at all poles. Permanent connection may only be carried out by an authorised electrician.
- Before starting your appliance please ensure that the nominal voltage and type of current specified on the rating plate are the same as those used at the place of installation. Please also refer to the rating plate for the type of fuse to be used.
- Prior to carrying out modifications on the appliance (on the worktop or front door) pull out the mains plug.
- The mains feed-line may only be replaced by the customer service or by an authorised electrician.

Dimensions of the appliance

Front and Side Views

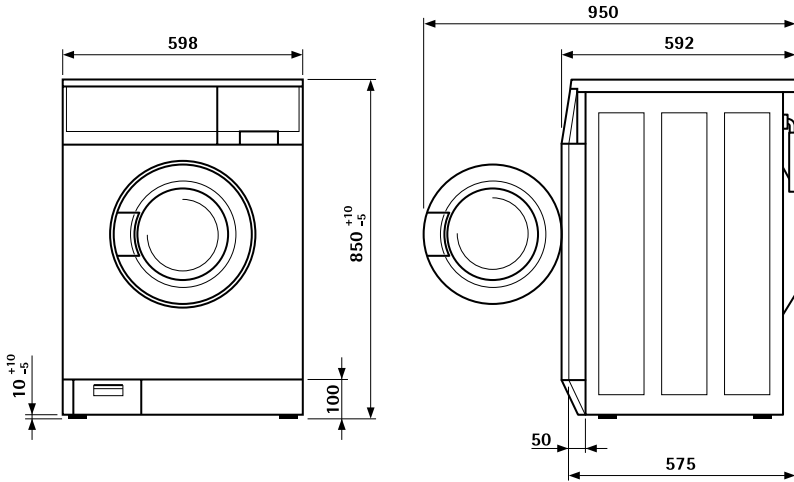

Rear View

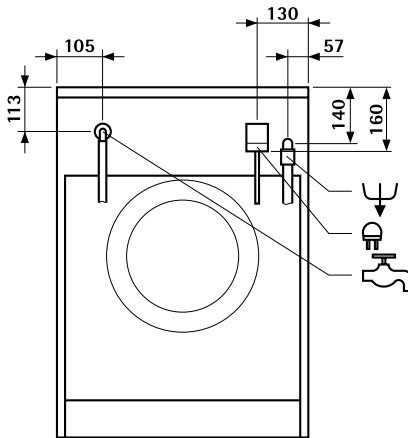

Installation of the appliance



Washing machines with arched covers are **not suited for installation beneath countertops**.

Transporting the appliance

- Do not lay the washing machine on the front or on the left side (seen from the front); otherwise the electrical components could become wet!
- Never transport the appliance without transportation protection. Remove the protection only at the place of installation! Transportation without protection can lead to damages to the appliance.
- Neither lift the appliance by an open door nor by the base.
- The appliance weighs approx. 85 kg.
- By transportation with a trolley: Place the trolley only sidewise.

Remove transportation protection

Attention! Be absolutely certain that all shipping braces have been removed before installing the appliance.

Store all shipping braces in a safe place in case they are required for future transport (moving).

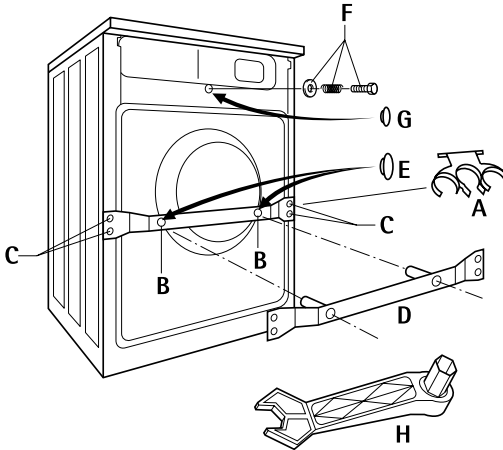

i Special spanner H and cover caps E (2 off) and G (1 off) are supplied with the appliance.

- 1.** Remove flexible tubing holder A.
- 2.** Remove the two screws B with special spanner H.
- 3.** Remove the four screws C.
- 4.** Detach transportation rail D.
- 5.** Close the two large openings with the cover caps E.

Attention! Press cover caps forcefully in, so that they snap into the rear wall (protecting the interior of the appliance against sprayed water).
- 6.** Drive in the screws C into the four small holes again.
- 7.** Remove the screw and compression spring F with special spanner H, cover the hole with caps G.

Attention! Press cover caps forcefully in, so that they snap into the rear wall (protecting the interior of the appliance against sprayed water).

Prepare the installation place

- The installation surface must be clean and dry, free of floor wax and other smearing substances, so that the appliance does not slip off. Do not use any lubricant as sliding aid.
- Installation on a high-veil carpet or floor tiles with soft sponge backs is not recommended because the standing safety of the appliance is then no longer ensured.
- By installation surfaces with small-format tiles, lay a conventional rubber mat underneath.
- Small unevenness of the floor surface should never be levelled out by laying pieces of wood, carton or similar elements, but rather basically compensated by adjusting the screw feet.
- When it is unavoidable to install the appliance besides a gas or a coal-fuelled cooker, due to spatial reasons: insert a piece of heat-insulating board (85 x 57 cm) between the cooker and the washing machine; the board side facing the cooker must be provided with an aluminium foil.
- The washing machine may not be installed in a frost-endangered room. Frost-caused damages!
Flexible feed and drain tubings may not be crinkled or squeezed..

Installation on a concrete base

When installing on a concrete base, for safety reasons it is imperative that steel plates are installed, the washing machine is then installed in these plates. The steel plates are available from customer service under ET-No. 645 425 058.

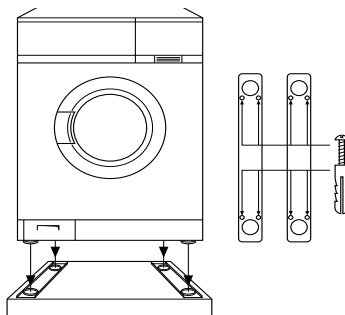

Installation on vibrating floors

In the case of floors that vibrate, especially wooden floors with floorboards that flex, a water-proof wooden panel of at least 15 mm thickness must be firmly screwed to at least 2 floor beams. If possible, install the appliance in a corner of the room: the wooden floor is more firmly supported in the corners and thus has less tendency to resonant vibration.

Levelling on uneven floors

Using the four adjustable threaded feet, compensation can be made for unevenness in the floor and the height of the appliance adjusted. The height can be adjusted over the range +10... -5 mm.

To adjust the feet use the special spanner supplied for removing the transport braces.

1. Slide the special key firmly onto the hexagon head of the threaded foot all the way to the stop.
2. Adjust the threaded feet so that the appliance is level and sits stably. The appliance must not rock across the corners when operating under load.
3. If necessary, check positioning with a spirit level.

Important! Never compensate for small areas of unevenness in the floor through the use of wooden wedges, cardboard or the like. Levelling should only ever be performed by adjusting the feet.

Power supply

Details on the mains voltage, type of current and the necessary fuse protection are to be found on the rating plate. The rating plate is above and behind the door.

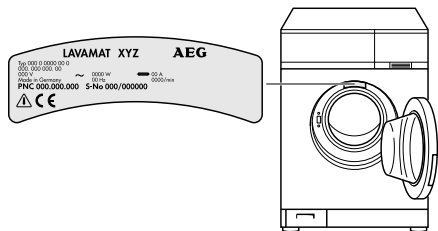

For permanent electrical connection within the electrical circuit, provisions must be made which allow for electrical disconnection of the appliance from the mains with a contact opening of at least 3 mm at all poles. Suitable devices include circuit breakers, fuses (threaded fuses must be entirely removed from the socket), ground fault circuit interrupters and contactors. Permanent connection may only be carried out by an authorised electrician.

- CE** This appliance conforms to the following EC directives
- "Low-Voltage Directive" 73/23/EEG dated 19 February 1973 and Directive amendment 93/68/EEG
 - "EMC Directive" 89/336/EEG dated 3 May 1989 and Directive amendment 93/68/EEG

Water connection



The washing machine is provided with safety devices which prevent reverse pollution of drinking water and conform to the State regulations issued by water supply authorities (e.g. in Germany: DVGW Directives). Further protective measures in the installation are hence unnecessary.

Attention! Appliances for cold water connection may not be connected to warm water!

Permissible water pressure

Water pressure must be equal to a least 1 bar ($= 10\text{N/cm}^2 = 0.1\text{ MPa}$), and no more than 10 bar ($= 100\text{N/cm}^2 = 1\text{ MPa}$).

- By more than 10 bar: connect a pressure reduction valve upstream.
- By less than 1 bar: Unscrew the flexible inlet tubing on the magnetic inlet valve on one side of the appliance and remove the flow meter (thereby remove the sieve by means of a pair of pointed pliers and then remove the rubber washer behind it). Remount the sieve.

Water feed

A flexible pressure tubing of 1.3 m length is supplied.

If a longer feed tubing is needed, a complete VDE-approved tubing set with mounted screw connections, supplied by our customer service, should be used exclusively.

- For washing machines without Aqua-Control, tubing sets are available in lengths of 2.2 m, 3.5 m and 5 m.
- For washing machines with Aqua-Control, tubing sets are available in lengths of 2.0 m, 2.9 m and 3.9 m.

Attention! Under no circumstances may tubing be pieced together for the purpose of lengthening!



Sealing rings are either inserted in plastic nuts of the tubing screw connection or contained in an accompanying packet. Do not use other seals.



1. Connect the angled hose connector to the machine.

Attention! Plastic nut at the tube coupling may only be hand tightened.

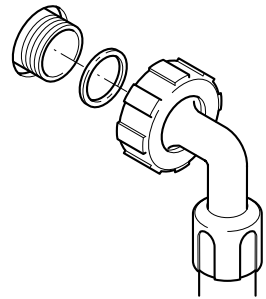

2. Connect the straight hose connector to a water tap with an R 3/4 (inch) thread.

Attention! Only tighten the plastic nuts on the hose connectors by hand.

3. By opening the water tap slowly prior to the initial operation, check whether the connection is tight.

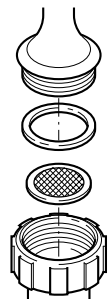

Water drain-off

The drain-off tubing can be connected either to a siphon or be hanged in a washing or sink basin or in a bathtub.

For extension (max. 3 m floor length and up to 80 cm high) only original tubing may be used. The customer service supplies drain-off tubing of 2.7 and 4m lengths.

Water drain-off inside a siphon

The spout at the end of the tubing fits all common siphon types.



Make the connection spout/siphon secure with a tubing clip.

Water drain-off inside a basin

For hanging in a wash basin, sink or bath, the drain hose must be prevented from moving using the detachable elbow supplied.

The tube could otherwise be pushed out of the basin by the reactive force imparted by draining water.

Small sink basins are not suitable!



Fasten the elbow on the water tap or on the wall by means of the hole.

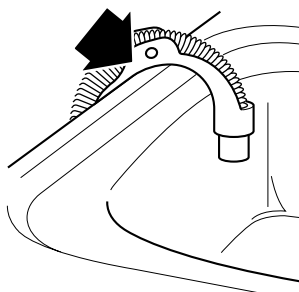

Delivery heights above 1 m

Every washing machine is provided with a suds pump for draining the washing/rinsing suds, which can deliver liquids via the drain-off tubing up to a height of 1 m, measured from the standing level of the machine.

For delivery heights above 1 m please establish contact with the AEG customer service.

Technical data

Height x Width x Depth	85x60x60cm
Depth with open door	95cm
Height adjustment	approx. +10/-5 mm
Weight when empty	approx. 85 kg
Load (depending on the program)	max. 5 kg
Area of use	Household
Wash cycle drum speed	max. 53 min ⁻¹ r.p.m.
Spin cycle drum speed	see type plate
Water pressure	1-10 bar (=10–100 N/cm ² = 0.1 – 1.0 MPa)

SERVICE DEPARTMENTS

ELECTROLUX s.r.o.
divize AEG Domáci spotřebiče
Servis
Hanusova ulice
140 21 Praha 4
Tel.: 02/61 12 26 21/26 22
Telefax: 02/61 12 29 47
tř. Gen. Píky 3
613 00 Brno
Tel.: 05/45 24 51 13
Telefax: 05/45 24 51 03

GUARANTEE CONDITIONS

Záruka, servis a náhradní díly

Přečtěte si tento návod k obsluze a dodržujte v něm uvedené rady a pokyny. V mnoha případech si budete moci vyjasnit jakékoli pochybnosti sami a tudíž vyhnout se zbytečným voláním do servisu. Předchozí části nazvané „Co dělat, když...“ a „Servis“ obsahuje doporučení, co by se mělo zkontrolovat dříve, než zavoláte servisního technika.

Jestliže po těchto kontrolách závada stále existuje, zavolejte vaše nejbližší autorizované servisní středisko AEG. Ujistěte se, že můžete sdělit model a seriové číslo spotřebiče. Tyto informace naleznete na datovém štítku přístroje. Originální náhradní díly lze koupit od autorizovaných středisek servisu AEG.

Podmínky záruky

My, výrobce, zaručujeme, že jestliže během 12 měsíců od data zakoupení tohoto spotřebiče AEG se tento spotřebič nebo jakákoli jeho část ukážou jako vadné pouze z důvodu vadného zpracování nebo vadného materiálu, provedeme podle našeho uvážení buď opravu nebo výměnu téhož bez placení za práci, materiál nebo přepravu za předpokladu, že

- spotřebič byl správně instalován a používán pouze na napětí na štítku jmenovitých hodnot
- spotřebič byl používán pouze pro normální domácí účely a v souladu s pokyny výrobce pro provoz a údržbu a na spotřebiči neprováděla servis, údržbu ani opravu jiná než námi autorizovaná osoba
- všechny servisní práce podle této záruky musí provádět servis AEG nebo jím autorizované středisko
- každý vyměněný spotřebič nebo vyměněná vadná součást se stanou naším vlastnictvím
- tato záruka platí vedle vašich zákonných nebo jinak právně podložených práv

Výjimky – tato záruka se nevztahuje na:

- poškození nebo požadavky vzniklé v důsledku přepravy, nesprávného použití nebo nedbalosti, výměny žárovek a snímatelných částí ze skla nebo plastických hmot
- náklady spojené s požadavky na odstranění závad spotřebiče, který je nesprávně instalován
- spotřebiče, které jsou používány v komerčním prostředí včetně pronajímaných
- země Evropského společenství. Lze použít standardní záruku, ale zajištění, že spotřebič splňuje normy platné v příslušné zemi, kam byl spotřebič dopraven, je na zodpovědnosti a na náklady vlastníka. Může být vyžadován doklad o koupi.

Model.....

Číslo výrobku (Prod. No.).....

Seriové číslo (Serial. No.).....

eventuelně KD / ...

Bezpečnost

Přečtěte si tento návod a varovná upozornění na začátku tohoto návodu.

Výrobce nezodpovídá za vady způsobené nesprávně používaným výrobkem nebo výrobkem používaným pro jiné účely než jsou účely specifikované v tomto návodu.

Technické změny výrobku vyhrazeny.

V případě problému volejte zdarma 0800/16 00 16

INDEX

C

Calcium	30
Conditioner	9, 11, 16, 18
liquid	9, 18
Conditioning	24
Cotton Mixtures	15
Cottons	11, 15, 22, 24
Customer Service	27
Customer service	26, 44, 47

D

Danger of freezing	31
Danger of Frost	6
Delicates	12, 15, 23, 24
Detergent	9, 16, 18
Detergent for Soaking	9, 18

E

Easy-Cares	11, 15, 22, 24
ECO Valve	13
ECO valve	32

G

Guarantee	6, 27
-----------------	-------

L

Linen	11, 15, 22, 24
Liquid detergent	18

M

Main Wash	10, 22
Main Wash Detergent	9, 18

N

Net Curtains	14, 15, 23
--------------------	------------

O

Open Door	17, 18, 21, 29
-----------------	----------------

P

Pre Wash	10, 22
Pre Wash Detergent	9, 18
Program Progress	20
Pump Out	11, 21

Q

Quick Wash	10, 22
------------------	--------

R

Rating Plate	9, 39
Rating plate	47
Rinse	10
additional rinse	33
Rinse Hold	10, 11, 20, 21

S

Saving Energy	11, 22
Silk	15
Soaking	11, 24
Softener	8, 9, 18
Spin	10, 11, 20, 24
Stain	10, 18, 22
Stain Remover	9, 10, 18
Stains	8, 30
Starch	9, 18
Starching	11, 24
Stopping the Program	20

W

Washing

coloured	14
delicate	14, 15
easy-care	15
lightly soiled	8
normally soiled	8

Water

circulation pump	9, 32
emergency drain	31
hardness	8, 16
pump out	11, 21
softener	8, 9, 16, 18
water cooling	33
Water Softener	18
Woollens	12, 15, 23, 24

SERVICE

If a malfunction should occur at the appliance, refer first to the section "What to do when ..." in these user instructions. If you do not find any applicable instructions there, contact your customer service centre. (Addresses and telephone number can be found in the "Service Departments" section.)

Be well prepared before you phone. This facilitates the diagnosis and the decision as to whether a customer service visit is necessary. With our checklist you can gather important information before making your call:

Make a note of the PNC number and the S-number.

Both of these numbers can be found on the rating plate on the inside of the door of your washing machine.

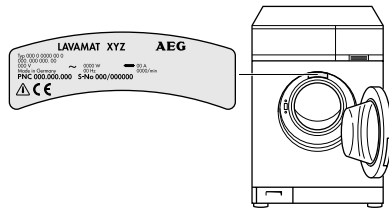

PNC

S-No.

In addition to this please establish if possible:

- How is the malfunction noticeable ?
- Under what circumstances does the malfunction occur?

You will be charged even during the warranty period

- if you could have corrected the malfunction yourself with the help of the malfunctions table (see "What to do when ..." section),
- if the customer service technician is required to make several trips because he had not received all relevant information before his visit, and must return, for example, to pick up replacement parts. This additional driving can be avoided if your telephone call is well prepared, as described above.

AEG Hausgeräte GmbH
Postfach 1036
D-90327 Nürnberg

<http://www.aeg.hausgeraete.de>

© Copyright by AEG

H 243 288 540 - 01 - 1099