

SCENICVIEW A17-2 / A19-1 / A17-2 DVI / A19-1 DVI / RE17-1 DE / RE19-1 DE



We make sure

FUJITSU COMPUTERS
SIEMENS

Are there ...

... any technical problems or other questions which you would like to be clarified?

Please contact
our help desk (see Warranty Booklet).

The latest information on our products, tips, updates, etc., can be found on the internet at:
www.fujitsu-siemens.com

This manual was produced by
cognitas. Gesellschaft für Technik-Dokumentation mbH – www.cognitas.de

Published by

Fujitsu Siemens Computers GmbH

Order No.: **A26361-K1063-Z121-1-7619**

Edition **1**

AG 0106 01/06

**SCENICVIEW
A17-2 / A19-1 /
A17-2 DVI / A19-1 DVI /
RE17-1 DE / RE19-1 DE**

Operating Manual

January 2006 edition

VESA, DDC and DPMS are registered trademarks of Video Electronics Standards Association.

All rights, including rights of translation, reproduction by printing, copying or similar methods, in part or in whole, are reserved.

Offenders will be liable for damages.

All rights, including rights created by patent grant or registration of a utility model or design, are reserved.

Delivery subject to availability. Right of technical modification reserved.

This manual was produced by
cognitas. Gesellschaft für Technik-Dokumentation mbH
www.cognitas.de

Copyright © Fujitsu Siemens Computers GmbH 2006

Contents

Introduction.....	1
Notational conventions	2
Important notes.....	2
Safety notes.....	2
Cleaning	3
Transport	4
Power cable.....	4
Energy Star Guidelines.....	4
CE marking.....	4
FCC Class B Compliance Statement	5
Declaration of Conformity	5
Disposal and recycling	6
Checking the contents of the consignment.....	6
Installing an ergonomic video workstation.....	7
Mounting and removing the monitor base	8
Mounting monitor base	8
Removing monitor base	9
Connecting the monitor	10
Connecting cables to the monitor.....	10
Connecting cables to the computer	11
Operation of the monitor.....	12
Adjusting rake.....	12
Switching the monitor on/off	12
Notes on power management	13
Changing the monitor settings.....	14
Notes on ergonomic colour adjustment.....	19
Troubleshooting.....	20
Notes regarding the DIN EN ISO 13406-2 standard	22
Technical data	23
VESA-DDC-compatible VGA interface.....	24
Preset operating modes	24
Pin assignment D-SUB.....	25
Monitor port DVI-D.....	25

Introduction

Your new LCD (Liquid Crystal Display) monitor offers numerous features and functions, for example:

- TFT display (Thin Film Transistor; active matrix)
- minimal space requirements thanks to slim casing
- optimum ergonomic characteristics (totally distortion-free, excellent picture definition and colour purity right into the corners)
- high degree of brightness and good contrast
- presentation of up to 16.2 million colours (in conjunction with an appropriate graphics card)
- automatic scanning of horizontal frequencies from 31 to 81 kHz and refresh rates (vertical frequencies) from 56 to 75 Hz (absolutely flicker-free)
- digital screen controller with microprocessor for storing 18 different display modes
- freely adjustable colour alignment for matching the screen colours to the colours of various input and output devices
- convenient operation via integrated OSD (On-Screen-display) menu
- VESA-DDC compatibility
- VESA-FPMPMI compatibility (Flat Panel Monitor Physical Mounting Interface) - mechanical interface to swivel arm and wall bracket)
- plug&play capability
- power management for reducing power consumption when the computer is not in use
- compliance with the recommendations in accordance with TCO'03

In normal screen mode (dark characters against a light background) the monitor satisfies the ergonomic requirements for the GS symbol.

This operating manual contains important information you require to start up and run your LCD monitor.

A screen controller with VGA interface is required to control the SCENICVIEW A17-2 / A19-1 / A17-2 DVI / A19-1 DVI / RE17-1 DE / RE19-1 DELCD monitor. The monitor processes the data supplied to it by the screen controller. The screen controller/the associated driver software is responsible for setting the modes (resolution and refresh rate).

When putting the monitor into operation for the first time, the screen display should be optimally adapted to the screen controller used and adjusted in accordance with your needs (see Changing the monitor settings).

Target group

You don't need to be an "expert" to perform the operations described here. Do, however, read the "Important notes" chapter in the operating manual of the computer and in this operating manual.

In the event of any problems occurring, please contact your sales outlet or our help desk.

Additional information

Details of how you set the resolution and refresh rate are provided in the documentation on your screen controller/the associated driver software.

Notational conventions

The meanings of the symbols and fonts used in this manual are as follows:



Pay particular attention to text marked with this symbol. Failure to observe this warning endangers your life, destroys the device, or may lead to loss of data.



Supplementary information, remarks, and tips follow this symbol.

► Text which follows this symbol describes activities that must be performed in the order shown.

"Quotation marks" indicate names of chapters or terms.

Texts in italics indicate filenames and menu items.

Important notes



In this chapter you will find information regarding safety which is essential to take note of with your monitor.

Safety notes

This device complies with the relevant safety regulations for data processing equipment, including electronic office machines for use in an office environment. If you have any questions, contact your sales outlet or our help desk.

- The display surface of the LCD monitor is sensitive to pressure and scratches. You should therefore be careful with the display surface so as to avoid lasting damage (Newton rings, scratches).
- If the device is brought into the installation site from a cold environment, condensation can form. Before operating the device, wait until it is absolutely dry and has reached approximately the same temperature as the installation site.
- During installation and before operating the device, please observe the instructions on environmental conditions in the "Technical data" chapter as well as the instructions in the "Installing an ergonomic video workstation" chapter.
- To ensure sufficient ventilation, the intake and exhaust air openings of the monitor must never be blocked.
- The monitor automatically sets itself to a mains voltage in the range of 100 V to 240 V. Ensure that the local mains voltage lies within these limits.
- Ensure that the power socket on the device or the grounded mains outlet is freely accessible.
- The ON/OFF switch does not disconnect the device from the mains voltage. To completely disconnect the mains voltage, remove the power plug from the socket.
- The monitor is equipped with a power cable that complies with safety standards.

-
- Lay all cables so that nobody can stand on them or trip over them. When attaching the device, observe the relevant notes in the "Connecting the monitor" chapter.
 - No data transfer cables should be connected or disconnected during a thunderstorm.
 - Make sure that no objects (e.g. jewellery chains, paper clips, etc.) or liquids get inside the device (danger of electric shock, short circuit).
 - The device is not waterproof! Never immerse the device in water and protect it from spray water (rain, sea water).
 - In emergencies (e.g. damaged casing, elements or cables, penetration of liquids or foreign matter), switch off the unit, disconnect the power plug and contact your sales outlet or our help desk.
 - The monitor must be disposed of in accordance with the local regulations for disposal of special waste. The screen background lighting contains mercury. You must observe the applicable handling and disposal safety regulations for fluorescent tubes.
 - Only qualified technicians should repair the device. Unauthorised opening and incorrect repair may greatly endanger the user (electric shock, fire risk).
 - You may set only those resolutions and refresh rates specified in the "Technical data" chapter. Otherwise you may damage your monitor. If you are in any doubt, contact your sales outlet or our help desk.
 - Use a screen saver with moving images and activate the power management for your monitor to prevent still images from "burning in".
 - Keep this operating manual together with your device. If you pass on the device to third parties, you should include this manual.
 - We recommend that you place your device on an insensitive, non-slip surface. In view of the multitude of different finishes and varnishes used on furniture, it is possible that the feet of the device will mark the surface they stand on.

Cleaning

- Always pull out the power plug before you clean the monitor.
- Do not clean any interior parts yourself, leave this job to a service technician.
- Do not use any cleaning agents that contain abrasives or may corrode plastic.
- Ensure that no liquid will run into the system.
- Ensure that the ventilation areas of the monitor are free.
- The display surface of the LCD monitor is sensitive to pressure and scratches. Clean it only using a soft, slightly moistened cloth.

Wipe the monitor casing with a dry cloth. If the monitor is particularly dirty, use a cloth which has been moistened in mild domestic detergent and then carefully wrung out.

Transport

- Transport the monitor with care and only in its original packaging or another corresponding packaging fit to protect it against knocks and jolts.
- Never drop the LCD monitor (danger of glass breakage).

Power cable

To guarantee safe operation, use the cable supplied. Use the following guidelines if it is necessary to replace the original cable set.

- The female/male receptacles of the cord set must meet IEC60320/CEE-22 requirements.
- The cable has to be HAR-certified or VDE-certified. The mark HAR or VDE will appear on the outer sheath.
- For devices which are mounted on a desk or table, type SVT or SJT cable sets may be used. For devices which sit on the floor, only SJT type cable sets may be used.
- The cable set must be selected according to the rated current for your device.
- If necessary, replace the original power cable with a regular grounded 3-core mains lead.

Energy Star Guidelines



The Fujitsu Siemens LCD colour monitor is designed to conserve electricity by dropping to less than 1 W when it goes into standby, suspend and OFF mode. With this new power management the monitor qualifies for the U.S. Environmental Protection Agency's (EPA) Energy Star Computers award.

The EPA estimates that computer equipment uses 5 % percent of all business electricity and that this is growing rapidly. If all desktop computers and peripherals enter a low-power mode when not in use, the overall savings in electricity could amount to \$ 2 thousand million annually. These savings could also prevent the emission of 20 million tons of carbon dioxide into the atmosphere - the equivalent of 5 million automobiles.

As an Energy Star Partner, Fujitsu Siemens Computers GmbH has determined that this product meets the Energy Star guidelines for energy efficiency.

CE marking



The shipped version of this device complies with the requirements of the EEC directives 89/336/EEC "Electromagnetic compatibility" and 73/23/EEC "Low voltage directive".

FCC Class B Compliance Statement

The following statement applies to the products covered in this manual, unless otherwise specified herein. The statement for other products will appear in the accompanying documentation.

NOTE:

This equipment has been tested and found to comply with the limits for a "Class B" digital device, pursuant to Part 15 of the FCC rules and meets all requirements of the Canadian Interference-Causing Equipment Standard ICES-003 for digital apparatus. These limits are designed to provide reasonable protection against harmful interference in a residential installation. This equipment generates, uses and can radiate radio frequency energy and, if not installed and used in strict accordance with the instructions, may cause harmful interference to radio communications. However, there is no guarantee that interference will not occur in a particular installation. If this equipment does cause harmful interference to radio or television reception, which can be determined by turning the equipment off and on, the user is encouraged to try to correct the interference by one or more of the following measures:

- Reorient or relocate the receiving antenna.
- Increase the separation between equipment and the receiver.
- Connect the equipment into an outlet on a circuit different from that to which the receiver is connected.
- Consult the dealer or an experienced radio/TV technician for help.

Fujitsu Siemens Computers GmbH is not responsible for any radio or television interference caused by unauthorised modifications of this equipment or the substitution or attachment of connecting cables and equipment other than those specified by Fujitsu Siemens Computers GmbH. The correction of interferences caused by such unauthorised modification, substitution or attachment will be the responsibility of the user.

The use of shielded I/O cables is required when connecting this equipment to any and all optional peripheral or host devices. Failure to do so may violate FCC and ICES rules.

Declaration of Conformity

This device complies with Part 15 of the FCC Rules. Operation is subject to the following two conditions: (1) this device may not cause harmful interference, and (2) this device must accept any interference received, including interference that may cause undesired operation.

Product name:	Colour LCD Monitor
Trade name:	Fujitsu Siemens Computers Inc.
Model number(s):	SCENICVIEW A17-2 / A19-1 / A17-2 DVI / A19-1 DVI / RE17-1 DE / RE19-1 DE
Name of responsible party:	Fujitsu Siemens Computers Inc. 1250E. Arques Avenue Sunnyvale, CA 94085 U.S.A.
Contact person:	Schroettle-Henning, Bernd
Phone No.:	(408) 746-8256
Fax No.:	(408) 746-8299

We, Fujitsu Siemens Computers Inc., hereby declare that the equipment bearing the trade name and model number specified above was tested confirming to the applicable FCC Rules under the most accurate measurement standards possible, and that all the necessary steps have been taken and are in force to assure that production units of the same equipment will continue to comply with the Commissions requirements.

Disposal and recycling

This device has been manufactured to the highest possible degree from materials which can be recycled or disposed of in a manner that is not environmentally damaging. The device may be taken back after use to be recycled, provided that it is returned in a condition that is the result of normal use. Any components not reclaimed will be disposed of in an environmentally acceptable manner.

If you have any questions on disposal, please contact your local office, our help desk, or:

Germany	Belgium	Switzerland
Fujitsu Siemens Computers GmbH Remarketing und Recycling D-33106 Paderborn Tel.: +49 5251 / 81 80 10 Fax: +49 5251 / 81 80 15 <i>www.fujitsu-siemens.de/wvm</i>	RECUPEL Boulevard Reyers, 80 B-1030 Brussels Tel.: +32 2 / 706 86 16 Fax: +32 2 / 706 86 13 E-Mail: info@recupel.be <i>www.recupel.be</i>	SWICO Schweizerischer Wirtschaftsverband der Informations-, Kommunikations- und Organisationstechnik A list of the SWICO Acceptance places can be found at: <i>www.swico.ch</i>

Checking the contents of the consignment



The display surface of the LCD monitor is sensitive to pressure and scratches. Always hold the device by the casing!

- ▶ Unpack all the individual parts.
- ▶ Check the delivery for damage incurred during transportation.
- ▶ Check whether the delivery agrees with the details in the delivery note.
The complete LCD monitor package includes:
 - one monitor
 - one monitor base
 - one data cable (D-SUB)
 - one data cable (DVI-D) - only for monitors with digital input
 - one power cable
 - one audio cable
 - a CD with software for the picture calibration of the monitor
 - one Warranty Booklet
 - one "Getting Started" manual (two volumes)

Should you discover that the delivery does not correspond to the delivery note, notify your local sales outlet immediately.



We recommend that you keep the original packaging material. You may need the packaging in the future if you need to transport your device.

Installing an ergonomic video workstation

Before you set up your equipment, you should select a suitable position for working at the monitor. Please observe the following advice when installing a video workstation.

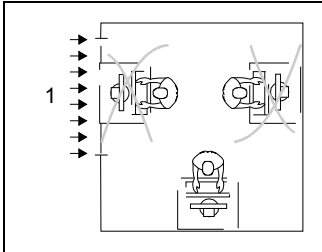

1 = Windows

Avoid direct and reflected glare.

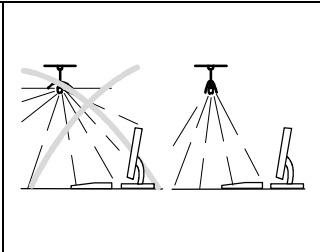

Avoid glare from electric lighting.

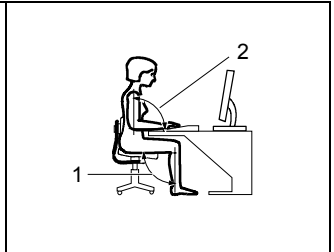

1 = approx. 90° and more

2 = approx. 90°

Remember to maintain correct posture.

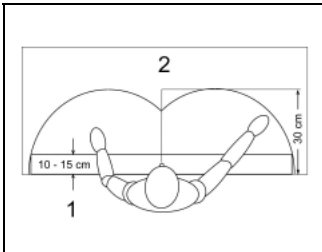

1 = Bearing surface for palms of hands

2 = Reaching area for frequently used equipment

Position the keyboard where it is easiest to reach.

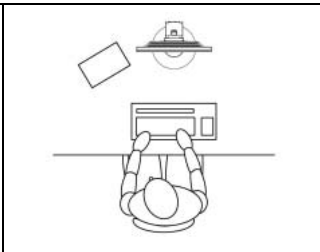

Example layout of monitor, keyboard and copy-holder

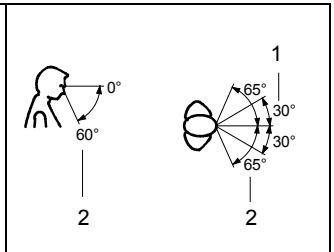

1 = Preferable viewing sector

2 = Permissible viewing sector

Position the monitor for optimum viewing. The viewing distance to the monitor should be approximately 50 cm.

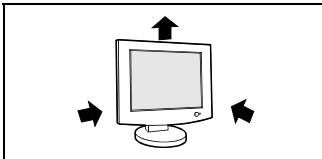

Keep ventilated areas clear.

Depending on the situation, the use of a swivel arm or wall bracket (VESA FPMPI), are available from specialised dealers, may be advisable. For this purpose the monitor base must be removed beforehand as described in the "Mounting and removing the monitor base" chapter.

Mounting and removing the monitor base

Mounting monitor base

On delivery the monitor base is removed.

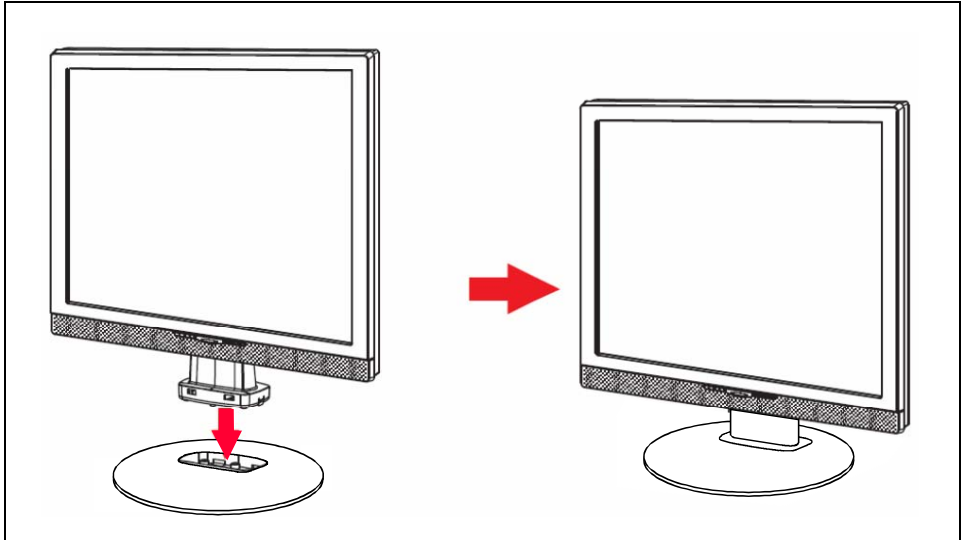

Removing monitor base

Before you can use a swivel arm or a wall bracket, you must remove the entire monitor base:

- ▶ Switch off the monitor and pull the power plug out of the power socket.



The display surface is susceptible to scratching!

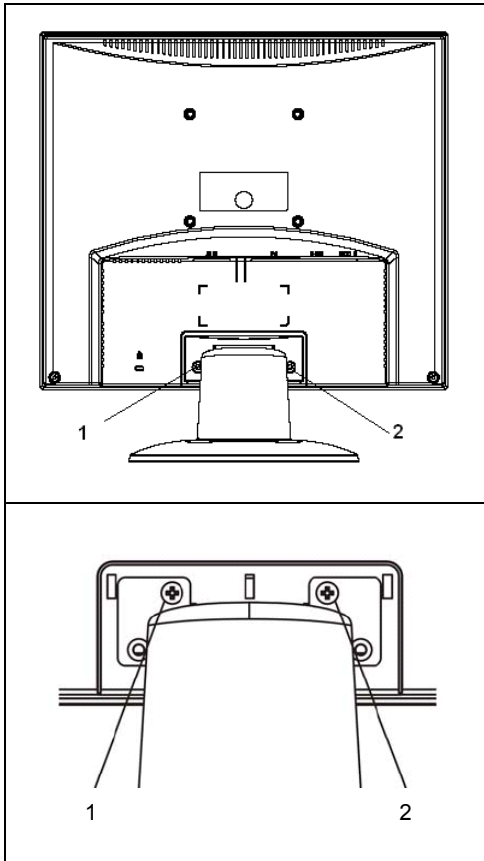

- ▶ Lay the monitor on its face on a soft surface.
- ▶ Remove all cables.
- ▶ Unscrew the screws (1, 2) and remove the cover.

- ▶ Unscrew the screws (1, 2) and remove the monitor base.

You can now mount a swivel arm or a wall bracket as per VESA FPMPMI with 100 mm hole spacing with four screws.

Note on mounting a swivel arm or a wall bracket

For instructions on how to mount the swivel arm or wall bracket, please see the documentation for the swivel arm or wall bracket.

We recommend always operating the monitor in the standard position (4:3, wide format, landscape mode).

Connecting the monitor



Observe the "Safety notes" in the "Important notes" chapter in this operating manual. CE conformance and optimum picture quality are guaranteed only if you use the data cable supplied.

Do not cover the ventilation openings of the monitor.

The computer power plug must be pulled out!

- ▶ Be sure that the monitor and the computer are switched off.

Connecting cables to the monitor

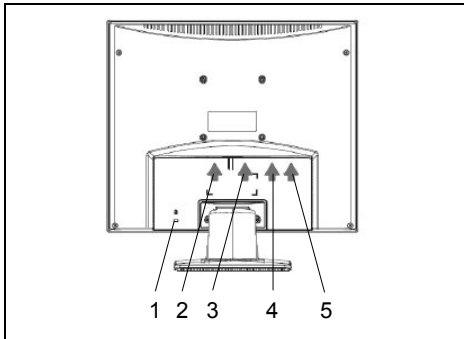

- 1 = Security slot for "Kensington Lock"
- 2 = Power connector
- 3 = DVI-D connector
(only for monitors with digital input)
- 4 = D-SUB connector (ANALOG)
- 5 = AUDIO-IN connector

The data cables supplied have two 15-pin D-SUB connectors / two 24-pin DVI connectors for connection to the monitor and to the computer.

- ▶ Select the suitable data cable for your computer.
 - Digital graphics card with DVI interface: DVI connector (only for monitors with digital input)
 - Graphics card with VGA interface: D-SUB connector
- Information on the computer connections and interfaces is contained in the operating manual for your computer.
- ▶ Connect one of the connectors of the data cable to the D-SUB connector (4) or the DVI-D connector (3) on the monitor and secure the plug-in connection by tightening the safety screws.



The monitor automatically detects the input when only one signal source is connected.

-
- ▶ Insert one plug of the audio line in the AUDIO IN (5) socket on the monitor and make sure it is properly engaged.
 - ▶ Plug the power cable supplied into the power connector (1) of the monitor.
 - ▶ Mount the cover over the connections.



A lock (Kensington Lock) can be mounted in the security slot (1) to protect the monitor from theft. A Kensington Lock is not included in the consignment of the monitor.

Connecting cables to the computer

Information on the computer connections and interfaces is contained in the operating manual for your computer.



If your computer has two monitor ports ("onboard" screen controller and separate graphics card), the monitor port for the separate graphics card is usually active.

- ▶ Connect the data cable to the (active) monitor port on the computer and secure the plug-in connection by tightening the safety screws.
- ▶ Insert the other plug of the audio line in the audio output of the computer.
- ▶ Plug the connector of the mains cable provided into the monitor outlet of the computer or into a properly earthed outlet and ensure a safe connection.
- ▶ Plug the power connector of the computer into a properly grounded mains outlet.



When you start working with your monitor for the first time you should install the appropriate graphics drivers for your application software. Details of how to do this are provided in the documentation on your screen controller/the associated driver software.

Operation of the monitor

The monitor offers the following possibilities that enable it to be optimally adjusted for the respective user and the respective situation.

Adjusting rake

The rake of the monitor can be adjusted by -5° (forward) and $+20^{\circ}$ (back) from its vertical position.

- ▶ Grasp the monitor with both hands on the right and left edge of the casing and adjust it to the desired rake.

Switching the monitor on/off

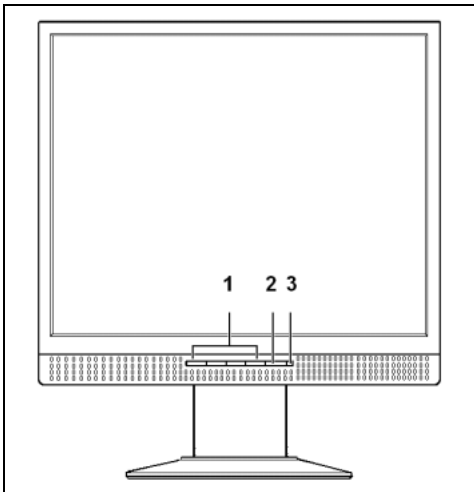

- 1 = Buttons for the OSD menu (On-Screen-display)
- 2 = ON/OFF switch
- 3 = Power indicator

The ON/OFF switch (2) is used for switching the monitor on and off.

The power indicator (1) lights up blue when the monitor and computer are switched on. The power indicator lights up orange when the monitor does not receive a video signal or is in the energy saving mode. The power indicator goes off when the monitor is switched off.

When you switch the computer system on, you must proceed in the following order:

- ▶ First switch on the LCD monitor with the ON/OFF switch (2).
- ▶ Then switch on the computer.



If your computer has a power management function (energy-saving mode), you should read the "Notes on power management" section in this chapter.

Notes on power management

If your computer is equipped with power management, the monitor can support this function fully. Here the monitor does not distinguish between the individual energy-saving modes of the computer (standby mode, suspend mode and OFF mode), as it is capable of immediately switching into the mode with the highest energy-saving effect.

Stage	ON	Power-Saving Mode
Power indicator	lights up blue	lights up orange
Function	the monitor is working normally	the screen is dark
Power consumption	normal < 40 W (17") normal < 50 W (19")	reduced to < 1 W

If your computer detects inactivity (no input) it sends an appropriate signal to the monitor to reduce the power consumption (energy-saving mode). The power indicator of the monitor changes colour to indicate the status change.

Once an input is made at the computer the screen contents are redrawn and full power is restored.

For detailed information on how energy-saving mode operates refer to the operating manual or technical manual of the computer.



When the monitor is switched to the energy-saving mode by the power management system a power consumption of up to 1 W is maintained to feed the circuit for redrawing the screen contents.

To completely switch off the power consumption, switch off the computer or pull the plug of the monitor power cable out of the monitor socket of the computer.

Changing the monitor settings

When putting the monitor into operation for the first time, the screen display should be optimally adapted to the screen controller used and adjusted in accordance with your needs.

Basic monitor settings

If one of the operating systems Windows 95/98, Windows NT, Windows Me, Windows 2000, Windows XP or OS/2 (with Windows emulation installed) is used, the basic monitor settings can be set with the CD supplied.

- ▶ Open the *Readme* file on the CD and follow the instructions in the file.

Your monitor should now already be properly adjusted. If none of the above operating systems is used or minor corrections are to be made to the screen display, then change the monitor settings with the OSD menu.

Changing the monitor settings with the buttons of the control panel



Use the buttons of the control panel to make the following monitor settings directly while the OSD menu is switched off.

Performing auto-adjustment of the monitor

- ▶ Press the AUTO button for approx. 1 second while the OSD menu is switched off. The *Auto Processing* message is displayed. Picture quality and position are set to optimum values for your system.

Adjusting background lighting

- ▶ Press the < button for calling the *Brightness/Contrast* setting window.
- ▶ Press the > or < button to select brightness or contrast and press the MENU button.
- ▶ Press the > or < button to adjust brightness or contrast.
- ▶ Press the AUTO button to exit the function.

Adjusting the volume

- ▶ Press the > button for calling the *Speaker Volume* setting window.
- ▶ Press the > or < button to adjust the volume.
- ▶ Press the AUTO button to exit the function.

Monitor settings using the OSD menu

With the buttons on the control panel, call up and use the integrated OSD (On-Screen display) menu.





The OSD menu is available in different languages. The English menu names are used in the following description (default setting). With the OSD function *Language* in the  menu you can select another language.

To set the OSD menu, perform the following steps:

- ▶ Press the MENU button to activate the OSD menu.

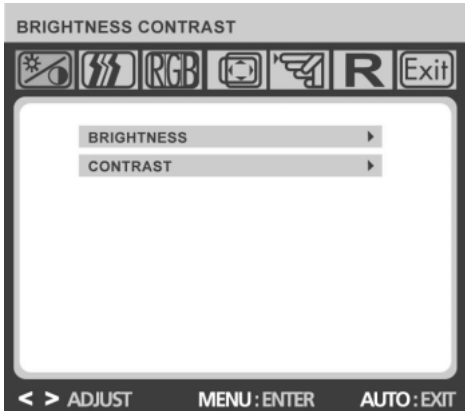
The main menu appears on the screen (on the top) with icons for the setting functions.



The first symbol () is highlighted. In the lower part of the display the associated functions are shown.

- ▶ If necessary, press the < or > button to mark another icon (e.g. ).
- ▶ Press the MENU button to select the highlighted icon.

The corresponding setting window is displayed.



The first function (*AUTO ADJUSTMENT*) is highlighted.

- ▶ If necessary, press the < or > button to mark another function.
- ▶ Press the MENU button to select the highlighted function.
- ▶ Press the < or > button to adjust the value for the selected function.
- ▶ Press the AUTO button to exit the function.
- ▶ If necessary, press the button < or > to mark another function or press the AUTO button to return to the main menu.

All changes are stored automatically.

If you want to change other settings, select the corresponding function from the OSD main menu. All possible adjustments of the main menu are described in the following.

Adjusting the brightness and contrast

	Calling the setting window
Brightness	Setting the brightness of the display With this function you change the brightness of the background lighting.
Contrast	Setting the contrast of the display With this function you modify the contrast of bright colour tones.

	If the contrast is set too high, bright surfaces can no longer be distinguished from very bright surfaces. If the contrast is set too low, the maximum brightness will not be achieved.
--	---

Adjusting size and position

	Calling the setting window
Auto Adjustment	Performing auto-adjustment of the monitor Picture quality and position are set to optimum values for your system.
H-Position	Adjusting the horizontal position With this function you move the picture to the left or to the right.
V-Position	Adjusting the vertical position With this function you move the picture up or down.
Clock	Setting synchronisation With this function you adjust the picture width to eliminate vertical picture disturbances.
Phase	Eliminating picture interference With this function you fine-tune your monitor to eliminate picture interference.
Sharpness	Adjusting the picture quality in case of interpolation With this function you set the sharpness of the interpolation filter. Thus the display can be optimised for pictures or texts.

Setting colour temperature and colours

	Calling the setting window
	<p>Selecting the colour temperature</p> <p>The "warmth" of the screen colours is set using the colour temperature. The colour temperature is measured in K (= Kelvin). You can select from <i>6500 K</i>, <i>9300 K</i>, <i>Customer Colour</i> and <i>sRGB</i>.</p> <p><i>Custom Colour</i> = User-defined colours</p> <p><i>sRGB</i> = setting colour display according to the sRGB standard</p> <p>In the user-defined setting you can change the colour ratios of the basic colours (red, green, blue) as required.</p>

Setting display of the OSD menu

	Calling the setting window
OSD H-Position	<p>Setting the horizontal position of the OSD menu</p> <p>With this function you move the OSD menu to the left or to the right.</p>
OSD V-Position	<p>Setting the vertical position of the OSD menu</p> <p>With this function you move the OSD menu up or down.</p>
OSD Timeout	<p>Setting the display duration of the OSD menu</p> <p>With this function you select a value from 10 to 120 seconds.</p> <p>If the set time expires without a setting being made, the OSD menu is automatically faded out.</p>

Setting advanced options

	Calling the setting window									
Language	<p>Setting language for the OSD menu</p> <p>With this function you select the language for the OSD menu. The following languages are offered:</p> <table><tr><td><i>English</i> (default setting)</td><td><i>French</i></td><td><i>Polish</i></td></tr><tr><td></td><td><i>Spanish</i></td><td><i>Dutch</i></td></tr><tr><td><i>German</i></td><td><i>Italian</i></td><td><i>Russian</i></td></tr></table>	<i>English</i> (default setting)	<i>French</i>	<i>Polish</i>		<i>Spanish</i>	<i>Dutch</i>	<i>German</i>	<i>Italian</i>	<i>Russian</i>
<i>English</i> (default setting)	<i>French</i>	<i>Polish</i>								
	<i>Spanish</i>	<i>Dutch</i>								
<i>German</i>	<i>Italian</i>	<i>Russian</i>								
Input	<p>Selecting input signal (only for monitors with digital input)</p> <p>This function allows you to configure whether you want to use the analogue or the digital input, or whether the input to be used should be set automatically.</p>									
Speaker Volume	<p>Adjusting the volume</p> <p>With this function you adjust the volume for the playback via the integrated loudspeakers.</p>									
Information	With this function information (e.g. Resolution, H/V frequency) is displayed.									

Activating the factory settings

	<p>Activating the factory settings</p> <p>With this function all settings are reset to the factory settings without prompting for confirmation.</p>
---	---

Exiting the OSD menu

	Exiting the OSD menu
--	----------------------

Notes on ergonomic colour adjustment

If you select colours for the display in your application programmes, take note of the information below.

The primary colours blue and red on a dark background do not produce the minimum required contrast of 3:1 and are therefore not suitable for continuous text and data entry.

When using several colours for characters and background and giving the primary colours full modulation, you can obtain very suitable colour combinations (see the following table):

Background	Characters							
	black	white	purple	blue	cyan	green	yellow	red
black		+	+	-	+	+	+	-
white	+		+	+	-	-	-	+
purple	+	+		-	-	-	-	-
blue	-	+	-		+	-	+	-
cyan	+	-	-	+		-	-	-
green	+	-	-	+	-		-	-
yellow	+	-	+	+	-	-		+
red	-	+	-	-	-	-	+	



- + Colour combination very suitable
- Colour combination not suitable because colour locations are too close together, thin characters are not identifiable or rigorous focusing is demanded of the human eye.

Troubleshooting

Should an error occur, first check the following points. If the distortion is still not eliminated, the monitor should, if possible, be checked on another computer.

If you are unable to solve the problem, please inform our help desk.

Having this problem?	Check the following points:
No screen display (power indicator does not light)	<ul style="list-style-type: none">▶ Check whether the monitor is switched on.▶ Check whether the power cable on the monitor is connected correctly.▶ Check whether the computer is switched on.
No screen display (power indicator lights)	<ul style="list-style-type: none">▶ Check whether the computer is switched on.▶ Check whether the data cable for the monitor is correctly attached to the monitor port on the computer.▶ Press any key on the computer keyboard - the computer may be in energy saving mode.▶ Alter the brightness and/or contrast until you get a picture.
Message: Check Signal Cable	<ul style="list-style-type: none">▶ Check whether the data cable for the monitor is correctly attached to the monitor port on the computer.▶ Check whether the computer is switched on.
Message: Out of Frequency Please change the display mode to 1280x1024 with 60 Hz.	<p>The input signal (horizontal frequency and refresh rate) at the displayed input does not correspond to the technical monitor data.</p> <ul style="list-style-type: none">▶ Adjust the video frequency range using the computer software (see documentation for your computer or your graphics card).
Picture position is not correct	<p>The monitor recognises an undefined mode (see "Technical data").</p> <ul style="list-style-type: none">▶ Press the AUTO button to conduct the auto-adjustment of the screen.▶ Set the picture position with the OSD menu (see "Operation of the monitor").

Having this problem?	Check the following points:
Picture is shaking	<ul style="list-style-type: none"> ▶ Check whether the data cable for the monitor is correctly attached to the monitor port on the computer. ▶ Press the AUTO button to conduct the auto-adjustment of the screen.
Picture is wrongly adjusted	<ul style="list-style-type: none"> ▶ Press the AUTO button to conduct the auto-adjustment of the screen.
Picture disturbances (vertical lines) 	<ul style="list-style-type: none"> ▶ Press the AUTO button to conduct the auto-adjustment of the screen.
Picture disturbances (horizontal lines, picture noise) 	<ul style="list-style-type: none"> ▶ Press the AUTO button to conduct the auto-adjustment of the screen.
The screen becomes darker	The background lighting has a limited lifetime. If your monitor display should become too dark, the background lighting will have to be exchanged. <ul style="list-style-type: none"> ▶ Please contact our help desk.

Notes regarding the DIN EN ISO 13406-2 standard

Permanently unlit or lit pixels

The standard of production techniques today cannot guarantee an absolutely fault-free screen display. A few isolated constant lit or unlit pixels (picture elements) may be present. The maximum permitted number of pixels faults is stipulated in the stringent international standard ISO 13406-2 (Class II).

Example:

A 17" or 19" flat-screen monitor with a resolution of 1280 x 1024 has $1280 \times 1024 = 1310720$ pixels. Each pixel consists of three subpixels (red, green and blue), so there are almost 4 million subpixels in total. In accordance with ISO 13406-2 (Class II), a maximum of 6 pixels and 7 subpixels may be faulty.

Pixel	A pixel consists of 3 subpixels, normally red, green and blue. A pixel is the smallest element that can be generated by complete functionality of the display.
Subpixel	A subpixel is a separately addressable internal structure within a pixel that enhances the pixel function.
Cluster	A cluster contains two or more defective pixels or subpixels in a 5 x 5 pixel block.

Technical data

	17" LCD Monitor	19" LCD Monitor
Dimensions and weight		
Visible diagonals:	43 cm	48 cm
Dot pitch:	0.264 mm	0.294 mm
Maximal resolution:	1280 x 1024	1280 x 1024
Dimensions	Width: 380 mm	426 mm
incl.	Height: 400 mm	436 mm
monitor base:	Depth: 214 mm	214 mm
Dimensions box:	Width: 440 mm	505 mm
	Height: 466 mm	519 mm
	Depth: 128 mm	154 mm
Weight (without packaging):	3.7 kg	4.6 kg
Weight (with packaging):	4.8 kg	5.9 kg
Storable display modes:	15 (9 of which are preset)	
Accessories:	D-SUB data cable (1.8 m) DVI-D data cable (1.8 m) - only for monitors with digital input Power cable (1.8 m) Audio cable (1.8 m)	
Electrical data		
Video:	analogue, positive, 0.7 V _{pp} , 75 Ω Digital DVI-D - only for monitors with digital input	
Synchronisation:	Separate Sync. TTL, positive or negative	
Horizontal frequency:	31 kHz 81 kHz (multi-scanning)	
Refresh rate:	56 Hz 75 Hz	
Maximum pixel rate:	135 MHz	
Power supply:	switches automatically 100 V - 240 V, 50 Hz - 60 Hz ± 2 Hz, 1.2 A -0.6 A	
Total power consumption:	< 40 W (17") in normal mode < 50 W (19") in normal mode < 1 W in the energy-saving mode (standby mode, suspend mode and OFF mode)	
Sound output:	1 W left 1 W right	
Environmental conditions		
Environment class	3K2, IEC 721	
Rated range of operation:	15 °C 35 °C	
Humidity:	20 % 85 %	
Limit range of operation:	5 °C 35 °C	
Humidity:	20 % 85 %	
Condensation must be avoided.		

Environmental conditions

Environment class 3K2, IEC 721

Rated range of operation: 15 °C 35 °C
Humidity: 20 % 85 %

Limit range of operation: 5 °C 35 °C
Humidity: 20 % 85 %

Condensation must be avoided.

VESA-DDC-compatible VGA interface

Your monitor is equipped with a VESA-DDC-compatible VGA interface. VESA-DDC (Video Electronics Standard Association, Display Data Channel) is used as the communications interface between the monitor and the computer. If your computer is equipped with a VESA-DDC-compatible VGA interface, it can automatically read the data for ensuring optimum operation from your monitor and select the appropriate settings.



If the monitor is not yet displayed in the list of monitors, you can select the following monitor instead:

Fujitsu Siemens 4311 FA, 4312 FA, B17-2, P17-2, A17-1, S17-2, B19-2, P19-2

Preset operating modes



The picture position and size have been set to optimum values at the factory for the operating modes listed above. Depending on the screen controller used, it may be necessary to adjust the display position and size. In this case, you can change and save the settings (see "Operation of the monitor").

The following are the most frequently used of the preset operating modes:

Horizontal frequency	Refresh rate	Screen resolution
31.5 kHz	70 Hz	720 x 400
31.5 kHz	60 Hz	640 x 480
37.5 kHz	75 Hz	640 x 480
37.9 kHz	60 Hz	800 x 600
46.9 kHz	75 Hz	800 x 600
48.4 kHz	60 Hz	1024 x 768
60.0 kHz	75 Hz	1024 x 768
64.0 kHz	60 Hz	1280 x 1024
79.9 kHz	75 Hz	1280 x 1024

For ergonomic reasons, a screen resolution of 1280 x 1024 pixels is recommended. Because of the technology used (active matrix) an LCD monitor provides a totally flicker-free picture even with a refresh rate of 60 Hz.

Pin assignment D-SUB

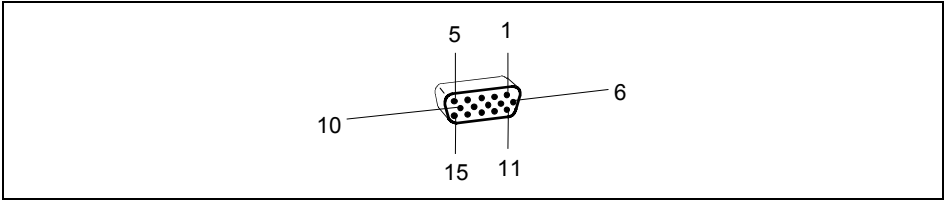

Pin	Meaning
1	Video input red
2	Video input green
3	Video input blue
4	not assigned
5	Earth
6	Red video earth
7	Green video earth
8	Blue video earth

Pin	Meaning
9	+5 V (DDC)
10	Sync. earth
11	not assigned
12	DDC-Data
13	H. sync
14	V. sync
15	DDC Clock

Monitor port DVI-D

(only for monitors with digital input)

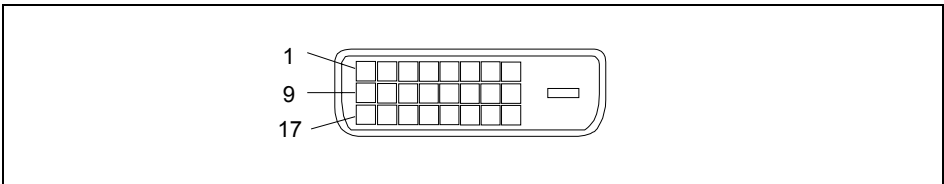

Pin	Meaning
1	TMDS Data2-
2	TMDS Data2+
3	TMDS Data 2/4 Shield
4	not connected
5	not connected
6	DDC Clock
7	DDC Data
8	Analogue Vertical Sync

Pin	Meaning
9	TMDS Data1-
10	TMDS Data1+
11	TMDS Data 1/3 Shield
12	not connected
13	not connected
14	+5V Power
15	Earth
16	Hot Plug Detect

Pin	Meaning
17	TMDS Data0-
18	TMDS Data0+
19	TMDS Data 0/5 Shield
20	not connected
21	not connected
22	TMDS Clock Shield
23	TMDS Clock-
24	TMDS Clock+