

# USER MANUAL

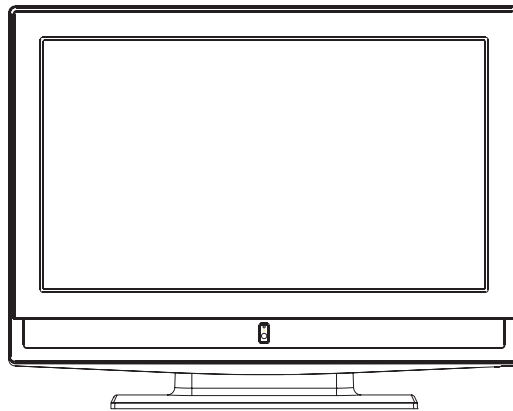

Model: LCD2622



Please read this User Manual carefully to ensure the proper use of this product and keep this manual for future reference

## Contents

Safety and warnings .....	2-6
Introduction .....	7
Installation .....	8-14
Remote Control .....	15
Operation .....	16-21
Trouble Shooting .....	22
Wall Mounting Holes Spacing and Location .....	23
Base Stand Disassemble Illustration .....	23

## ***SAFETY AND WARNINGS***

---



### IMPORTANT SAFETY INSTRUCTION

1. Read these safety instructions.
2. Keep these safety instructions.
3. Heed all warnings.
4. Follow all safety instructions.
5. Do not use this apparatus near water.
6. Clean only with dry cloth.
7. Do not block any ventilation openings. Install in accordance with the manufacturers instructions.
8. Do not install near any heat sources such as radiators, stoves, or other apparatus (including amplifiers) that produce heat.



9. Protect the power cord from being walked on or pinched particularly at power outlets, and the point where they exit from the apparatus.
10. Only use attachments/accessories specified by the manufacturer.
11. Unplug this apparatus during lightning storms or when unused for long periods of time.
12. Refer all servicing to qualified service personnel. Servicing is required when the apparatus has been damaged in any way, such as the power-supply cord or plug is damaged, liquid has been spilled or objects have fallen into the apparatus, the apparatus has been exposed to rain or moisture, does not operate normally, or has been dropped.
13. Apparatus must not be exposed to dripping or splashing and no objects filled with liquids, such as vases, should be placed on the apparatus.

***SAFETY AND WARNINGS***

	<table border="1"><tr><td>CAUTION</td></tr><tr><td>RISK OF ELECTRIC SHOCK</td></tr><tr><td>DO NOT OPEN!</td></tr></table>	CAUTION	RISK OF ELECTRIC SHOCK	DO NOT OPEN!	
CAUTION					
RISK OF ELECTRIC SHOCK					
DO NOT OPEN!					
<p>CAUTION TO REDUCE THE RISK OF ELECTRIC SHOCK, DO NOT REMOVE COVER (OR BACK). NO USER SERVICEABLE PARTS INSIDE. REFER SERVICING TO QUALIFIED SERVICE PERSONNEL.</p>					



The symbol indicates that dangerous voltages constituting a risk of electric shock are present within this unit.



The symbol indicates that there are important operating and maintenance instructions in the literature accompanying this unit.

**WARNING:**

To prevent fire or shock hazard, do not expose this appliance to rain or moisture.

***SAFETY AND WARNINGS***

---

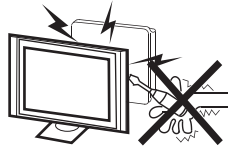

**Warning**

High voltages are used in the operation of this television receiver. Do not remove the cabinet back from your set. Refer servicing to qualified service personnel.

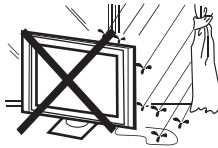

**Warning**

To prevent fire or electrical shock hazard, do not expose the television receiver to rain or moisture.



**Warning**

Do not drop or push objects into the television cabinet slots or openings. Never spill any kind of liquid on the television receiver.



**Caution**

Do not block the ventilation holes in the back cover. Adequate ventilation is essential to prevent failure of electrical components.



**Caution**

Do not trap the power supply cord under the television receiver.

## SAFETY AND WARNINGS

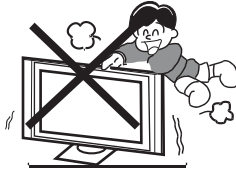

### Caution

Never stand on, lean on, or suddenly push the television or its stand. You should pay special attention to children. Serious injury may result if it falls.

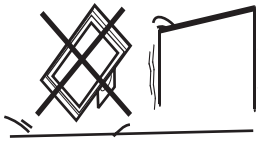

### Caution

Do not place your television on an unstable cart, stand, shelf or table. Serious injury to an individual, and damage to the television, may result if it falls.

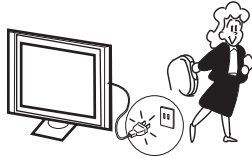

### Caution

When the television receiver is not used for an extended period of time, it is advisable to disconnect the AC power cord from the AC outlet.

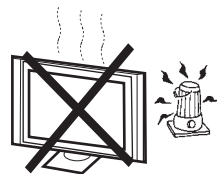

### Caution

Avoid exposing the television receiver to direct sunlight and other sources of heat. Do not stand the television receiver directly on other products which give off heat, e.g. video cassette players and audio amplifiers. Do not place naked flame sources, such as lighted candles on the television.

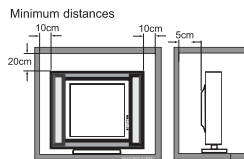

### Caution

If the television is to be built into a compartment or similar enclosure, the minimum distances must be maintained. Heat build-up can reduce the service life of your television, and can also be dangerous.

## ***SAFETY AND WARNINGS***

Thank you very much for purchasing this TV. To enjoy your product from the very beginning, read this manual carefully and keep it handy for easy reference.



### **INSTALLATION**

- Locate the TV in the room where light does not strike the screen directly.
- Total darkness or a reflection on the picture screen can cause eyestrain. Soft and indirect lighting is recommended for comfortable viewing.
- Allow enough space between the TV and the wall to permit ventilation.
- Avoid extremely warm locations to prevent possible damage to the cabinet or premature component failure.
- This TV can be connected to AC 100-240 Volts, 50/60 Hz. Never connect to a DC supply or any other power supply.
- Do not cover the ventilation openings when using the TV.

### **CAUTION**

Never tamper with any components inside the TV, or any other adjustment controls not mentioned in this manual. All LCD-TVs are high voltage instruments. When you clean up dust or water drops on the LCD PANEL or CABINET, the power cord should be pulled out from the receptacle, then wipe the TV with a dry soft cloth. During thunder and lightning, unplug the power cord and antenna cord to prevent damage to your TV.

All repairs to this TV should only be performed by qualified TV service personnel.

Earthing connection--- The apparatus shall be connected to MAINS socket outlet with a protective earthing connection.

MAINS plug or appliance coupler of the apparatus is used as disconnect device, it should remain readily operable.

Warning: Change or modifications to this unit not expressly by the part responsible for compliance could void the user's authority to operate the Equipment.

### **NOTE:**

This equipment has been tested and found to comply with the limits for a Class B digital device, pursuant to Part 15 of the FCC Rules. These limits are designed to provide reasonable protection against harmful interference in a residential installation. This equipment generates, uses, and can radiate radio frequency energy and, if not installed and used in accordance with the instructions, may cause harmful interference will not occur in a particular installation. If this equipment does cause harmful interference to radio or television reception, which can be determined by turning the equipment off and on, the user is encouraged to try to correct the interference by one or more of the following measures:

- Reorient or relocate the receiving antenna.
- Increase the separation between the equipment and receiver.
- Connect the equipment into an outlet on a circuit different from that to which the receiver is connected.
- Consult the dealer or an experienced radio TV technician for help.

Shield cables must be used with this unit to ensure compliance with the Class B FCC limits.

## Main features

- ① Used as Television, display terminal, PC display;
- ② High luminance, wide viewing angle;
- ③ Can store AIR 2-69, HRC 1-125, IRC 1-125, CATV 2-125 TV programs;
- ④ Dual HDMI interface
- ⑤ BTSC;

## Main parameter

Viewing Picture Size(diagonal)	26 "
Resolution	1366x768
Aspect Ratio	16 : 9
TV System	NTSC-M, NTSC-N
Video Signal System	NTSC/PAL/SECAM
Receiving Channel	AIR 2-69 HRC 1-125 IRC 1-125 CATV 2-125
Input Power Voltage	AC 100 V-240 V 50/60Hz
Power consumption	26 " 130 W
Audio Output Power (THD≤7%)	2x8W
Signal Input	Analog RGB(VGA)x1 High-Definition Multimedia Interface (HDMI)x2 Rear Composite Video Input x2 Rear S-Video x1 Audio Inputx4 YCb (Pb)Cr (Pr)x1 Rear Composite Video Output x1 Audio Outputx1 Side Composite Video Input x1 Side S-Video x1 Side HEAD PHONE x1
Horizontal definition (TV line)	Composite Video input ≥350 S-Video Input ≥400 Y Cb(Pb) Cr(Pr) ≥400



**Accessories**

AC Power Cord.....	1
Infrared Remote Control.....	1
User's Manual .....	1
Battery(AAA).....	2

HDMI cable is no included.

**Front panel**

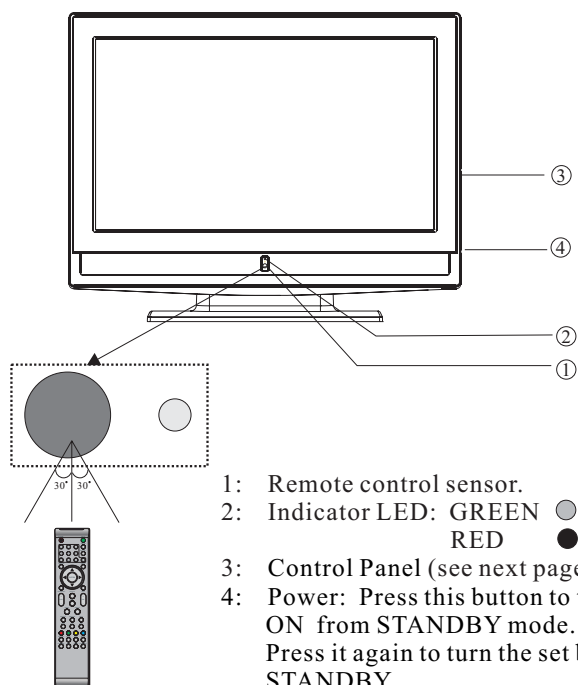

- 1: Remote control sensor.
- 2: Indicator LED: GREEN ● POWER ON.  
RED ● STAND BY.
- 3: Control Panel (see next page).
- 4: Power: Press this button to turn the unit ON from STANDBY mode. Press it again to turn the set back to STANDBY.
- 5: when TV is in standby mode, press CH + or CH - button in TV control panel will power on the TV.

**CONTROL PANEL**

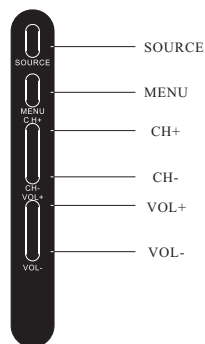

1. **SOURCE:**  
Display the input source menu.
2. **MENU:**  
To display main MENU.
3. **CH+/CH-**  
In TV mode, press “CH+” or “CH-” to change the channel up and down.  
In MENU,press “CH+” or “CH-” to select items in MENU.  
when TV is in standby mode, press “CH+” or “CH-” button in TV control panel will power on the TV.
4. **VOL+/VOL-**  
Adjust sound level.  
In MENU,adjust the item that you selected.

**REAR AV Connection**



All the terminals are(from left to right):

ANTENNA,AV3 INPUT&AV OUTPUT ,AUDIO INPUT, YPbPr, CVBS,S-VIDEO,VGA ,  
HDMI,AC POWER SOCKET

Note: 1.CVBS and S-VIDEO share one audio channel.

2. When HDMI1 port get DVI signal, the “PC Audio” channel is changed to receive the audio for HDMI1 port

3. When HDMI2 port get DVI signal, the “YPbPr Audio” channel is changed to receive the audio for HDMI2 port.

4.AV OUTPUT :

— — —when the source are AV 1,AV3, AV2(side),S-VIDEO1, S-VIDEO2(side)TV,the AV OUT Channel reproduce the input signals accordingly

— — —when the source are YPb Pr, DVD(optional)HDMI1/2 VGA, the AV OUT channel Reproduce the TV signal .

ANTENNA

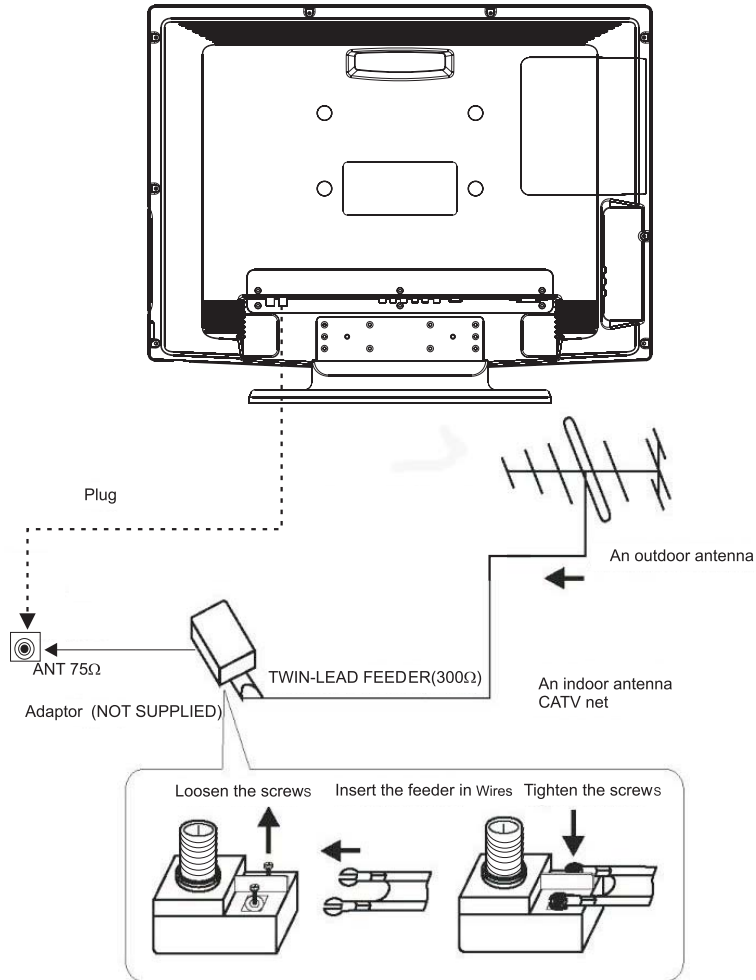

Note:  
Aerial connections: IEC (female).  
Input impedance: 75Ω unbalanced.

**PC**

**STEPS:**

Be sure both the TV and computer are set to Power off.

1. Connect VGA and audio cable.
2. Connect the power cord.
3. Power on the TV, switch to PC mode.
4. Power on the PC.

This sequence is very important.

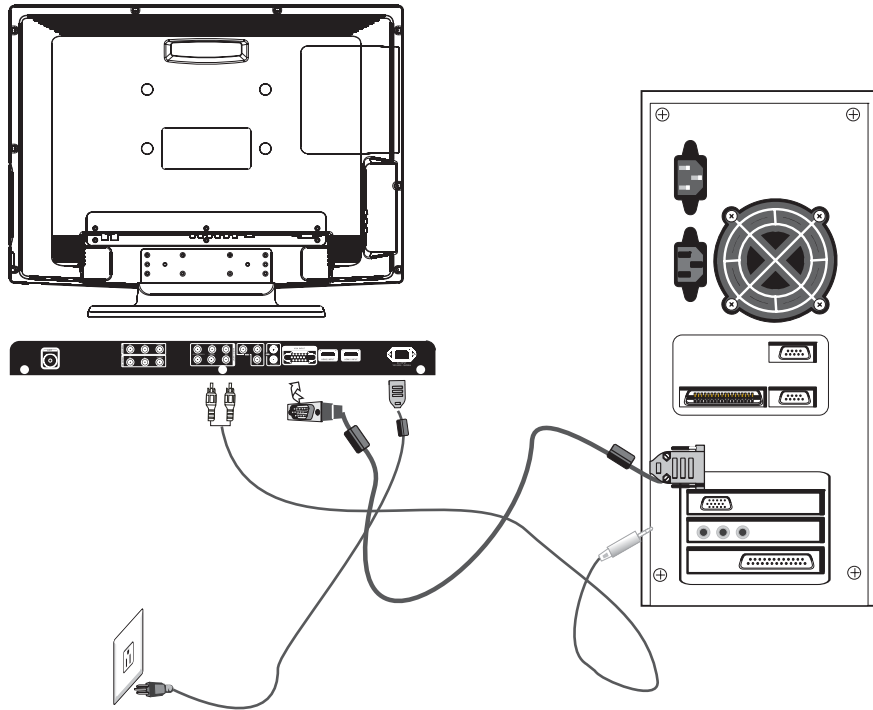

**PC**

**PRESET MODE(recommended resolution is 1024\*768@60Hz)**

	<b>RESOLUTION</b>	<b>V.Freq.(Hz)</b>	<b>H.Freq.(KHz)</b>
1	720*400	70	31.47
2	640*480	60	31.47
3	640*480	75	37.50
4	800*600	60	37.88
5	800*600	75	46.88
6	1024*768	60	48.36
8	1024*768	75	60.02
9	1280*1024	60	63.98

AV EQUIPMENT

This TV provides three inputs for Composite (A/V), two inputs for S-Video, and one input for Component (Y/Pb/Pr) .

You can use the input terminals on TV set rear as follows.

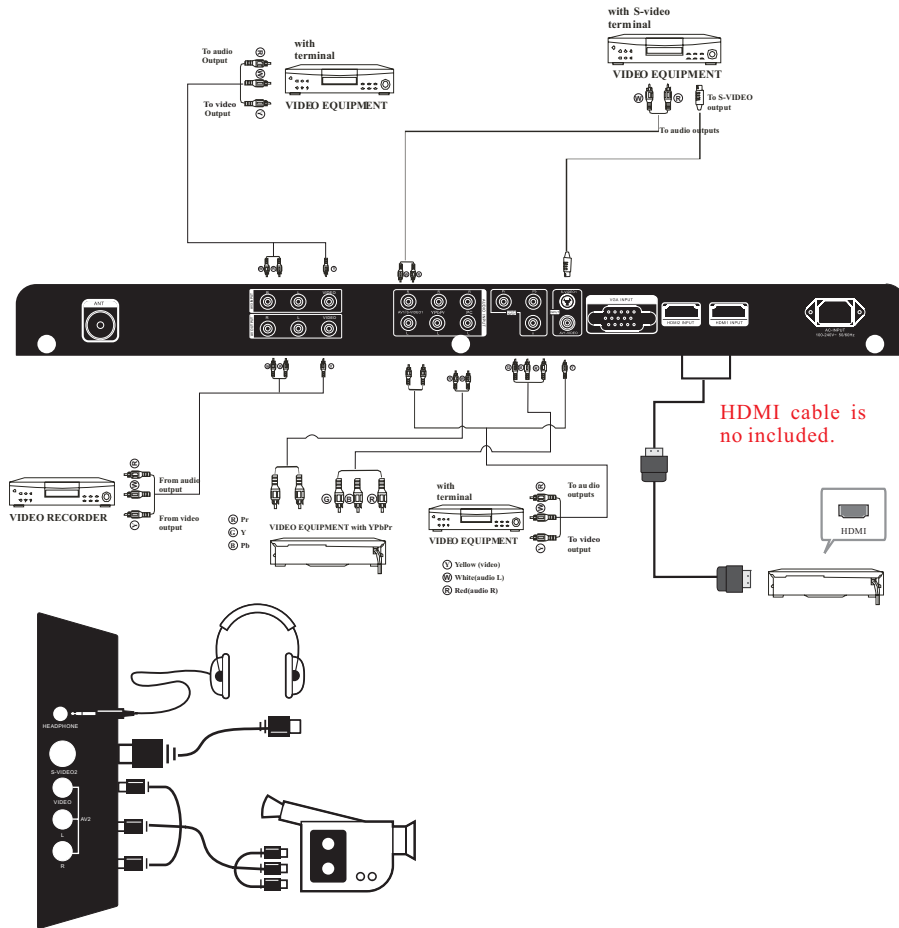

It can be connected to the following appliances: VCR, multi disc player, DVD, camcorder, video game or stereo system, etc.....

YPbPr can support these video formats:480i,576i,480p,576p,720p,1080i.

Note: AV2 and S-Video2 share the audio input channel.

**Insert Batteries Into the Remote Control**

1. Remove the battery cover.
2. Place 2 AAA batteries (included) making sure the polarity (+ or -) of the batteries matches the polarity marks inside the unit.
3. Mount the battery cover.

Replace the batteries when the TV set begins to show the following symptoms:

Operation is unsteady or erratic. Sometimes the TV set does not function with Remote Control Unit.

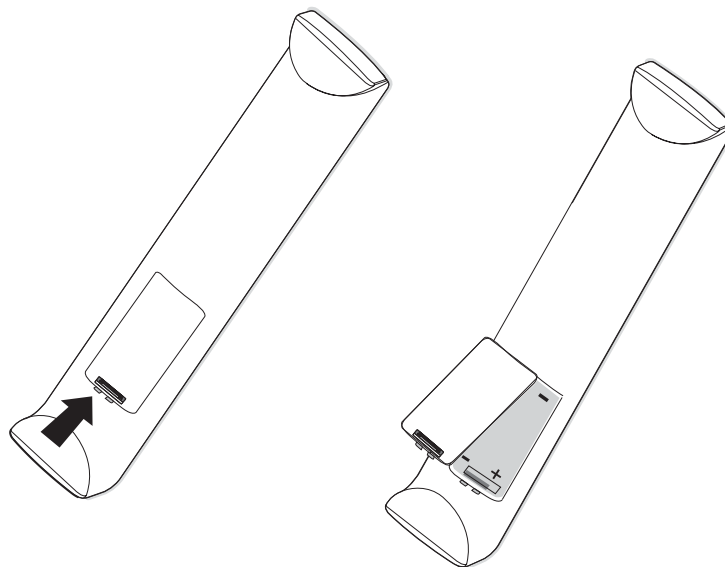

**Remark:**

- 1) Alkaline Battery Recommended.
- 2) Remove batteries when they are exhausted or if the remote control is not to be used for long time.

REMOTE CONTROL

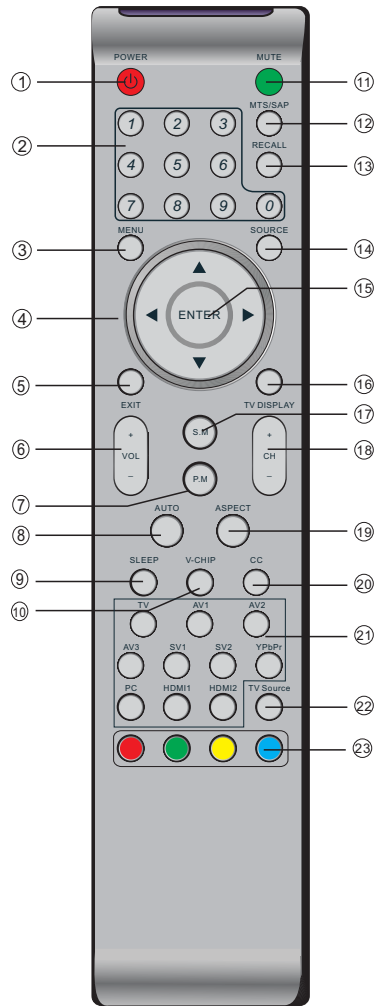

**NOTE:**  
4 coloured knobs on the bottom of the remote control is optional for other version

- 1: POWER**  
To set the TV standby or on.
- 2: NUMBER KEY:**  
For direct access to program. For a 2 (3) digit program number, The second (third) digit must be entered before the dash disappears. The number, the name (and the sound mode, in analogue mode) are displayed for a few seconds.
- 3: MENU**  
To display TV menu or to return to the previous menu.
- 4: CURSOR**  
To move within the menu.
- 5: EXIT**  
Used to exit menu.
- 6: VOL +/-**  
To adjust sound level.
- 7: P.M**  
To switch picture mode.
- 8: AUTO**  
Auto adjust in PC mode.
- 9: SLEEP**  
Set time to turn off the TV.
- 10: V-CHIP**  
Setting the V-CHIP level control.
- 11: MUTE**  
To disable or enable the sound.
- 12: MTS/SAP**  
Switch the sound stereo, SAP and mono.
- 13: RECALL**  
To access the previously viewed program.
- 14: SOURCE**  
Select EXT sources.
- 15: ENTER**  
Confirms selection.
- 16: TV DISPLAY**  
Displays/removes the program Information
- 17: S.M**  
To switch sound mode.
- 18: CH +/-**  
To access the next or previous Program.
- 19: ASPECT**  
To change picture aspect .
- 20: CC**  
Switch the close caption mode (cc1- Cc4, Text1-text4)
- 21: TV/AV/SV/HDMI/YPbPr/PC**  
Hot keys directly go to appointed source.
- 22. TV Source**  
Switch TV Source between air/cable.
- 23. Color Keys:** Reserved keys.



### 1. PICTURE MENU

The first item of the MENU is picture menu.  
You can adjust picture effects here, such as contrast, brightness, etc.  
Press ▼▲ to move, press ◀▶ to adjust.

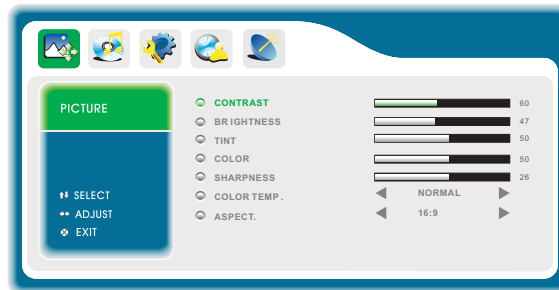

Note:

There are three colour temperature modes which can be selected : NORMAL, WARM, COOL.

### 2.SOUND MENU

The second item of the MENU is the sound menu.  
You can adjust the sound here.  
Press ▼▲ to move, press ◀▶ to adjust.

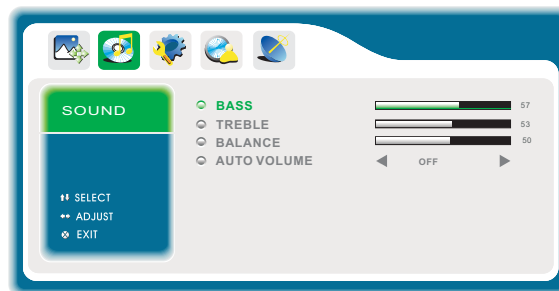

**3.FUNCTION MENU**

The third item of the MENU is the function menu.

You can adjust the settings below:

- 1).3D NR: adjust this item , you can see the noise reduction effect in the picture only for TV and AV source.
- 2).CLOSED CAPTION: switch close caption mode..
- 3).PARENT CONTROL: Enter V-chip control.
- 4).FACTORY DEFAULT: Reset all the settings to default value.

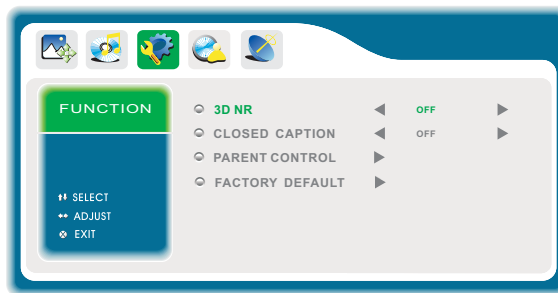

1.Parent control: put in the password, it will go into V-chip control menu. Factory default password is 6666.

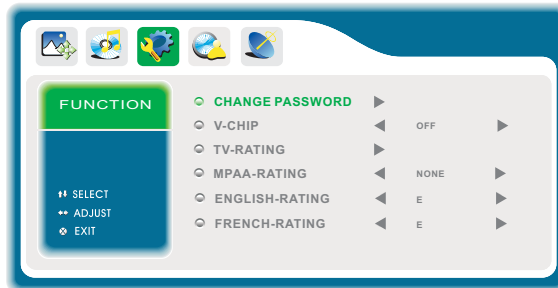

- 1).Change password:can change the current parent control password to the new password,you need to input the new password twice before it can be changed successfully.
- 2).V-chip:switch the V-chip ON or OFF.
- 3).TV-rating:it would goto TV-rating control menu as below.

**OPERATION**

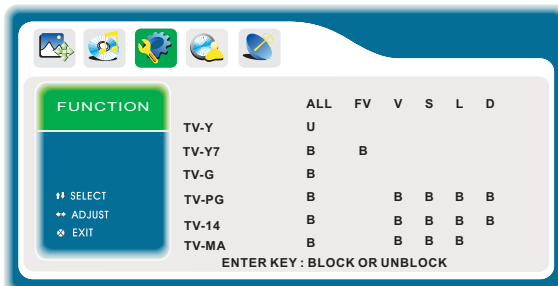

Rating Content		Content				
		FV (Fantasy violence)	V (Violence)	S (Sexual situation)	L (Adult language)	D (Sexually suggestive dialog)
Suggested age	TV-Y (All children)					
	TV-Y7(Direct to order children)	X				
	TV-G(General audience)					
	TV-PG(Parental Guidance suggested)		X	X	X	X
	TV-14(Parents strongly cautioned)		X	X	X	X
	TV-MA(Mature audience only)		X	X	X	

And use ENTER.key to switch block unblock V-chip feature.

4).Movie-rating:switch the movie-rating control level; none,G,PG, PG-13,R,NC-17,X.

Rating		Description
Age	G	General audiences, All ages admitted
	PG	Parental guidance suggested. Some material may not be suitable for children.
	PG-13	Parents strongly cautioned. Some material .may be inappropriate for children under 13.
	R	Restrict. Under 17 requires accompanying parent or adult guardian (age varies in some jurisdictions).
	NC-17	No one 17 and under admitted.
		X is an order rating that is unified with NC-17 but may be encoded in the data of order movies.

**OPERATION**

5).English-rating:switch the english-rating control level:E,C,C8+,G,PG,14+,18+.

Rating	Description	
Age	E	Exempt: Includes news, sports, documents and other information programming: talk shows, music videos, and variety programming.
	C	Children: Intended for younger children under the age of 8 years. Pays careful attention to themes that could threaten their sense of security and well-being.
	C8+	Children over 8 years old: Contains no portrayal of violence as the preferred, acceptable, or only way to resolve conflict; nor encourage children to imitate dangerous acts which they may see on the screen.
	G	General: Considered acceptable for all age groups, Appropriate viewing for the entire family, contains very little violence, physical, verbal or emotional.
	PG	Parental Guidance: Intended for a general audience, but may not be suitable for younger children (under the age of 8) because it could contain controversial themes or issues.
	14+	Over 14 Years: Could contain themes where violence is one of the dominant elements of the storyline But it must be integral to the development of plot or character. Language usage could be profane and nudity present within the context of theme.
	18+	Adults: Intended for viewers 18 years and older and might contain depictions of violence, which while related to the development of plot, character or themes, are intended for adult viewing. Could contain graphic language and portrayals of secretary and nudity.

6).French-rating:switch the French-rating control level:E, G,8ANS+,13 ANS+,16ANS+ 18ANS+.

Rating	Description	
Age	E	Exempt programming
	G	General :All ages and children, contains minimal direct violence, but may be integrated into the plot in a humorous or unrealistic manner .
	8ans+	General but inadvisable for young children :May be viewed by a wide public audience, but could contain scenes disturbing to children under 8 who cannot distinguish between imaginary and real situations. Recommended for viewing with paren.
	13ans+	Over 13 years: Could contain scenes of frequent violent scenes and intense violence.
	16ans+	Over 16 years: Could contain frequent violent scenes and violence.
	18ans+	Over 18 years: Only for adult viewing. Could contain frequent violent scenes and extreme violence.

**4.OSD MENU**

The fourth item of the menu is the OSD menu

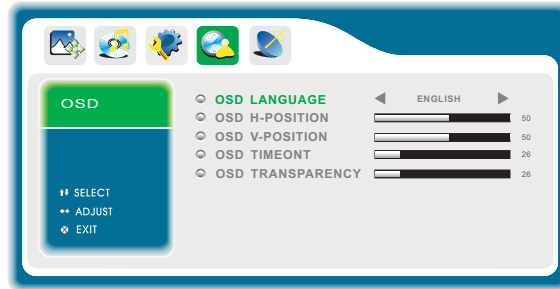

**5.CHANNEL MENU**

The fifth item of the MENU is channel menu(only use in TV source).  
You can complete channel search and setting here.

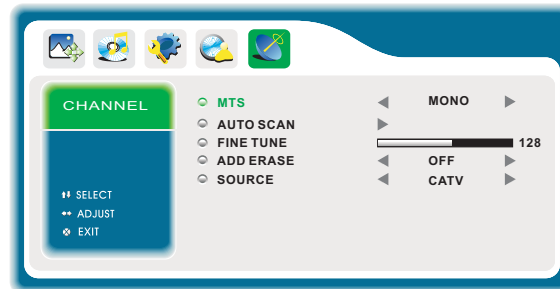

- 1). AUTO SCAN  
Search all the channels automatically.
- 2). FINE TUNE  
Fine tune the current program.
- 3). ADD ERASE
- 4). SOURCE  
Select the TV source to auto scan the TV program.

In PC Mode, there are two items that are different with other sources.

**1. PC MENU**

You can adjust picture here, such as contrast, brightness.  
Press ▼▲ to move, press ◀▶ to adjust.

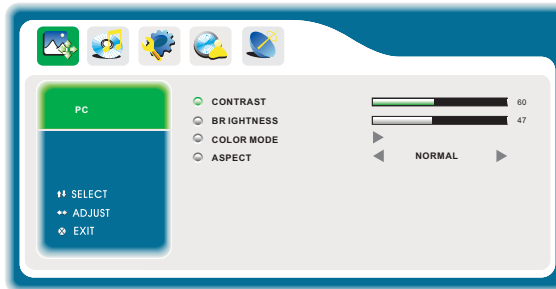

- ① colour mode: only four modes could be selected: normal, warm, cool, user.
- ② Press ▼▲ to move, press ◀▶ to adjust RGB value according to your personal taste under user mode.

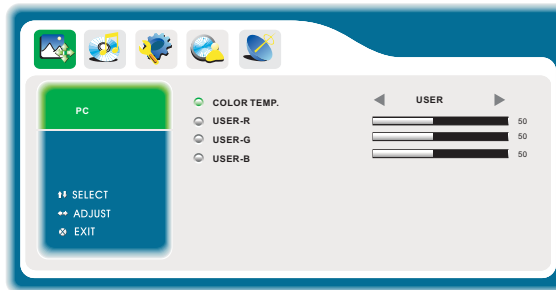





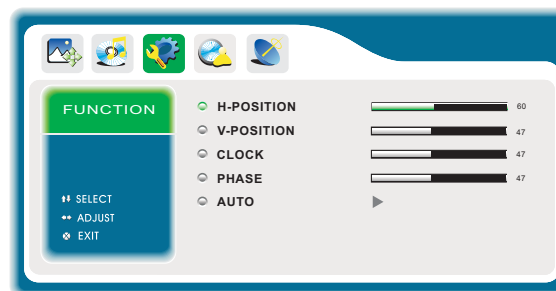











**2. FUNCTION MENU**

- 1). H-POSITION: adjust the horizontal position of the screen.
- 2). V-POSITION: adjust the vertical position of the screen.
- 3). CLOCK: fine tune the screen width.
- 4). PHASE: fine tune the phase of the screen.
- 5). AUTO: auto adjust to fit the screen.

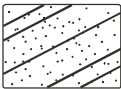

Rest of the set up , pls refer to previous introductions.

## Trouble shooting

Trouble phenomenon Symptom		Inspection Check
Picture	Audio	
 Snow	 Noise	antenna position, direction or connection
 Ghost	 Normal audio	antenna position, direction or connection
 Interference	 Noise	electronic equipment, car/ motorcycle, fluorescent light
 Normal Picture	 Mute	Volume (check if mute is activated or if the audio system connections are not correct)
 No picture	 Mute	Power cord is not inserted Power switch is not ON Contrast and brightness/volume setup Press standby key on the remote control for inspecting
 No colour	 Normal audio	Colour control
 Picture breaking up	 Normal audio or weak	retune channel
 No colour	 Noise	TV system

The LCDTV panel is built with very high precision technology giving you fine picture details in vibrant color. Occasionally, a few non-active pixels may appear on the screen as a fixed point of red, green, blue, black or white. Please note this does not affect the performance of the product.

## Wall Mounting Holes Spacing and Location

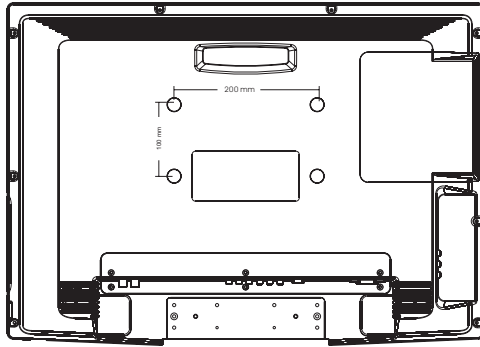

## Base Stand Disassemble Illustration

How to remove the stand from the TV

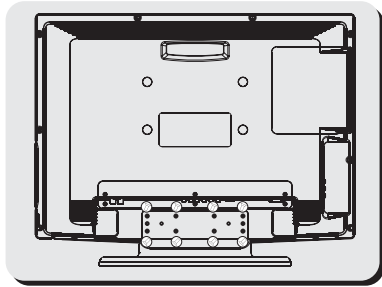

1. Use the screwdriver to remove the screws from the screw location.

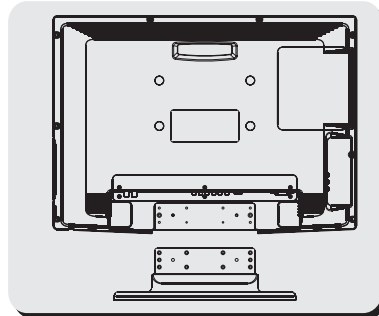

1. Remove the base stand from the Main body.

Main accessories

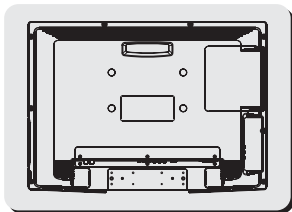

Main body

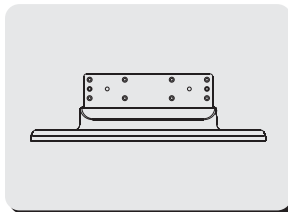

Base Stand

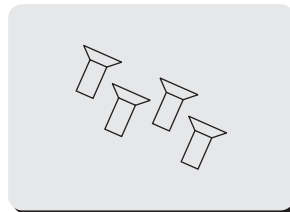

8 Screws





This symbol on the product or in the instructions means that your electrical and electronic equipment should be disposed at the end of life separately from your household waste. There are separate collection systems for recycling in the EU. For more information, please contact the local authority or your retailer where you purchased the product.