

# BLUE-FLAME VENT-FREE PROPANE/LP GAS HEATER

## OWNER'S OPERATION AND INSTALLATION MANUAL

RP30D

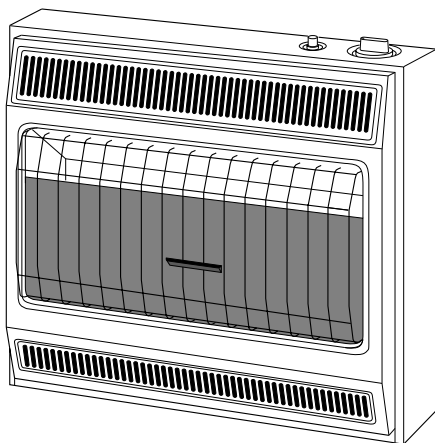

CGP20  
CGP20L

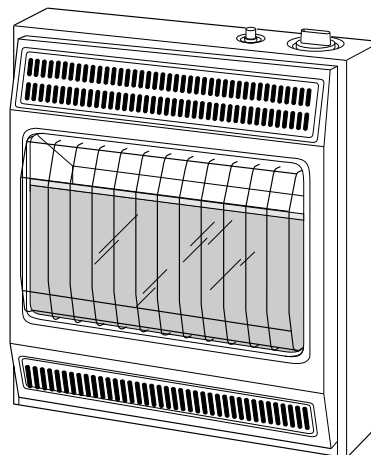

MODELS: CGP20, CGP20L, AND RP30D

**WARNING:** If the information in this manual is not followed exactly, a fire or explosion may result causing property damage, personal injury, or loss of life.

— Do not store or use gasoline or other flammable vapors and liquids in the vicinity of this or any other appliance.

— **WHAT TO DO IF YOU SMELL GAS**

- Do not try to light any appliance.
- Do not touch any electrical switch; do not use any phone in your building.
- Immediately call your gas supplier from a neighbor's phone. Follow the gas supplier's instructions.
- If you cannot reach your gas supplier, call the fire department.

— Installation and service must be performed by a qualified installer, service agency, or the gas supplier.

**WARNING:** Improper installation, adjustment, alteration, service, or maintenance can cause injury or property damage. Refer to this manual for correct installation and operational procedures. For assistance or additional information consult a qualified installer, service agency, or the gas supplier.

**WARNING:** This is an unvented gas-fired heater. It uses air (oxygen) from the room in which it is installed. Provisions for adequate combustion and ventilation air must be provided. Refer to *Air for Combustion and Ventilation* section on page 3 of this manual.

This appliance may be installed in an aftermarket\* manufactured (mobile) home, where not prohibited by state or local codes.

\*Aftermarket: Completion of sale, not for purpose of resale, from the manufacturer. (I.E. Installation of this product is permitted after the manufactured (mobile) home is sited)

This appliance is only for use with the type of gas indicated on the rating plate.

This appliance is not convertible for use with other gases.

Save this manual for future reference.

# BLUE-FLAME CGP20, CGP20L AND RP30D VENT-FREE PROPANE/LP GAS HEATER

## SAFETY INFORMATION

### WARNINGS

**IMPORTANT: Read this Owner's Manual carefully and completely before trying to assemble, operate, or service this heater. Improper use of this heater can cause serious injury or death from burns, fire, explosion, electrical shock, and carbon monoxide poisoning.**

** DANGER: Carbon monoxide poisoning may lead to death!**

**Carbon Monoxide Poisoning:** Early signs of carbon monoxide poisoning resemble the flu, with headaches, dizziness, or nausea. If you have these signs, the heater may not be working properly. **Get fresh air at once!** Have heater serviced. Some people are more affected by carbon monoxide than others. These include pregnant women, persons with heart or lung disease or anemia, those under the influence of alcohol, and those at high altitudes.

**Propane/LP Gas:** Propane/LP gas is odorless. An odor-making agent is added to propane/LP gas. The odor helps you detect a propane/LP gas leak. However, the odor added to propane/LP gas can fade. Propane/LP gas may be present even though no odor exists.

Make certain you read and understand all Warnings. Keep this manual for reference. It is your guide to safe and proper operation of this heater.

** WARNING: Any change to this heater or its controls can be dangerous.**

- This appliance is only for use with the type of gas indicated on the rating plate. This appliance is not convertible for use with other gases.
- Do not place propane/LP supply tank(s) inside any structure. Locate propane/LP supply tank(s) outdoors.
- This heater shall not be installed in a bedroom or bathroom.
- If you smell gas
  - shut off gas supply
  - do not try to light any appliance
  - do not touch any electrical switch; do not use any phone in your building
  - immediately call your gas supplier from a neighbor's phone. Follow the gas supplier's instructions
  - if you cannot reach your gas supplier, call the fire department
- Never install the heater
  - in a recreational vehicle
  - where curtains, furniture, clothing, or other flammable objects are less than 36 inches from the front, top, or sides of the heater
  - as a fireplace insert
  - in high traffic areas
  - in windy or drafty areas
- This heater needs fresh, outside air ventilation to run properly. This heater has an oxygen depletion sensor (ODS) pilot light safety system. The ODS shuts down the heater if not enough fresh air is available. See *Air for Combustion and Ventilation*, pages 3 through 5.
- Keep all air openings in the front and bottom of heater clear and free of debris. This will insure enough air for proper combustion.
- If heater shuts off, do not relight until you provide fresh, outside air. If heater keeps shutting off, have it serviced.
- Do not run heater
  - where flammable liquids or vapors are used or stored
  - under dusty conditions
- Never place any objects on the heater.
- Surface of heater becomes very hot when running heater. Keep children and adults away from hot surface to avoid burns and clothing ignition. Heater will remain hot for a time after shutdown. Allow surface to cool before touching.
- Make sure grill guard is in place before running heater.
- Carefully supervise young children when they are in same room with heater.
- Do not use heater if any part has been under water. Immediately call a qualified service technician to inspect the room heater and to replace any part of the control system and any gas control which has been under water.
- Turn off heater and let cool before servicing. Only a qualified service person should service and repair heater.
- Operating heater above elevations of 4,500 feet could cause pilot outage.
- To prevent performance problems, do not use propane fuel tank of less than 100 lbs. capacity.

## LOCAL CODES

Install and use heater with care. Follow all local codes. In the absence of local codes, use the latest edition of *National Fuel Gas Code ANSI Z223.1*, also known as NFPA 54\*.

\*Available from:

American National Standards Institute, Inc.  
1430 Broadway  
New York, NY 10018

National Fire Protection Association, Inc.  
Batterymarch Park  
Quincy, MA 02269

## UNPACKING

- Remove heater from carton.
- Remove all protective packaging applied to heater for shipment.
- Check heater for any shipping damage. If heater is damaged, promptly inform dealer where you bought heater.

## PRODUCT FEATURES

### Safety Device

This heater has a pilot with an Oxygen Depletion Sensor Shutoff System (ODS). The ODS/pilot is a required feature for vent-free heaters. The ODS/pilot shuts off the heater if there is not enough fresh air.

### Piezo Ignition System

This heater has a piezo ignitor. This system requires no matches, batteries, or other sources to light heater.

## PRODUCT IDENTIFICATION

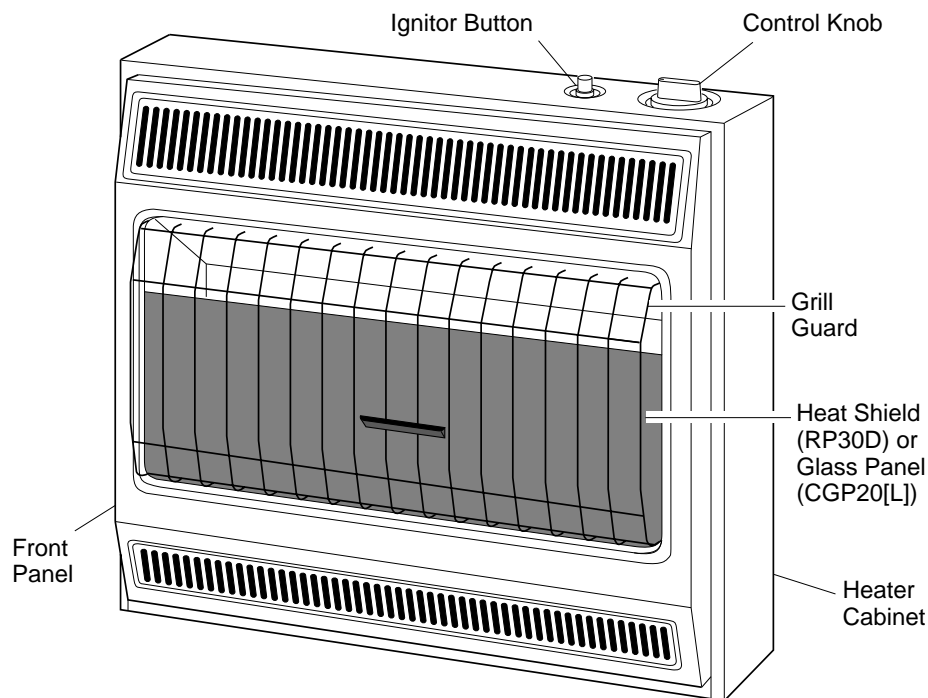

Figure 1 - Vent-Free Propane/LP Gas Heater

## AIR FOR COMBUSTION AND VENTILATION

**⚠ WARNING:** This heater shall not be installed in a confined space unless provisions are provided for adequate combustion and ventilation air. Read the following instructions to insure proper fresh air for this and other fuel-burning appliances in your home.

Today's homes are built more energy efficient than ever. New materials, increased insulation, and new construction methods help reduce heat loss in homes. Home owners weather strip and caulk around windows and doors to keep the cold air out and the warm air in. During heating months, home owners want their homes as airtight as possible.

While it is good to make your home energy efficient, your home needs to breathe. Fresh air must enter your home. All fuel-burning appliances need fresh air for proper combustion and ventilation.

Exhaust fans, fireplaces, clothes dryers, and fuel burning appliances draw air from the house to operate. You must provide adequate fresh air for these appliances. This will insure proper venting of vented fuel-burning appliances.

### PROVIDING ADEQUATE VENTILATION

The following is excerpts from *National Fuel Gas Code, NFPA 54/ANSI Z223.1, Section 5.3, Air for Combustion and Ventilation*.

All spaces in homes fall into one of the three following ventilation classifications:

1. Unusually Tight Construction;
2. Unconfined Space;
3. Confined Space.

The information on pages 3 through 5 will help you classify your space and provide adequate ventilation.

### Unusually Tight Construction

The air that leaks around doors and windows may provide enough fresh air for combustion and ventilation. However, in buildings of unusually tight construction, you must provide additional fresh air.

**Unusually tight construction is defined as construction where:**

- a. walls and ceilings exposed to the outside atmosphere have a continuous water vapor retarder with a rating of one perm ( $6 \times 10^{-11}$  kg per pa-sec- $m^2$ ) or less with openings gasketed or sealed **and**
- b. weather stripping has been added on openable windows and doors **and**
- c. caulking or sealants are applied to areas such as joints around window and door frames, between sole plates and floors, between wall-ceiling joints, between wall panels, at penetrations for plumbing, electrical, and gas lines, and at other openings.

If your home meets all of the three criteria above, you must provide additional fresh air. See *Ventilation Air From Outdoors*, page 5.

If your home does not meet all of the three criteria above, proceed to page 4.

### Confined and Unconfined Space

The *National Fuel Gas Code (ANSI Z2123.1, 1992 Section 5.3)* defines a confined space as a space whose volume is less than 50 cubic feet per 1,000 Btu per hour (4.8  $m^3$  per kw) of the aggregate input rating of all appliances installed in that space and an unconfined space as a space whose volume is not less than 50 cubic feet per 1,000 Btu per hour (4.8  $m^3$  per kw) of the aggregate input rating of all appliances installed in that space. Rooms communicating directly with the space in which the appliances are installed\*, through openings not furnished with doors, are considered a part of the unconfined space.

\* Adjoining rooms are communicating only if there are doorless passageways or ventilation grills between them.

*Continued*

# BLUE-FLAME CGP20, CGP20L AND RP30D VENT-FREE PROPANE/LP GAS HEATER

## AIR FOR COMBUSTION AND VENTILATION

**Continued**

### DETERMINING AIR FLOW FOR HEATER LOCATION

#### Determining if You Have a Confined or Unconfined Space

Use this worksheet to determine if you have a confined or unconfined space.

**Space:** Includes the room in which you will install heater plus any adjoining rooms with doorless passageways or ventilation grills between the rooms.

1. Determine the volume of the space (length x width x height).

Length x Width x Height = \_\_\_\_\_ cu. ft. (volume of space)

*Example:* Space size 20 ft. (length) x 16 ft. (width) x 8 ft. (ceiling height) = 2560 cu. ft. (volume of space)

If additional ventilation to adjoining room is supplied with grills or openings, add the volume of these rooms to the total volume of the space.

2. Divide the space volume by 50 cubic feet to determine the maximum Btu/Hr the space can support.

\_\_\_\_\_(volume of space) ÷ 50 cu. ft. = (Maximum Btu/Hr the space can support)

*Example:* 2560 cu. ft. (volume of space) ÷ 50 cu. ft. = 51.2 or 51,200 (maximum Btu/Hr the space can support)

3. Add the Btu/Hr of all fuel burning appliances in the space.

Vent-free heater \_\_\_\_\_ Btu/Hr  
 Gas water heater\* \_\_\_\_\_ Btu/Hr  
 Gas furnace \_\_\_\_\_ Btu/Hr  
 Vented gas heater \_\_\_\_\_ Btu/Hr  
 Gas fireplace logs \_\_\_\_\_ Btu/Hr  
 Other gas appliances\*+ \_\_\_\_\_ Btu/Hr  
 Total = \_\_\_\_\_ Btu/Hr

*Example:*

Gas water heater	40,000	Btu/Hr
Vent-free heater +	20,000	Btu/Hr
Total	=	60,000 Btu/Hr

\* Do not include direct-vent gas appliances. Direct-vent draws combustion air from the outdoors and vents to the outdoors.

4. Compare the maximum Btu/Hr the space can support with the actual amount of Btu/Hr used.

\_\_\_\_\_ Btu/Hr (maximum the space can support)

\_\_\_\_\_ Btu/Hr (actual amount of Btu/Hr used)

*Example:* 51,200 Btu/Hr (maximum the space can support)

60,000 Btu/Hr (actual amount of Btu/Hr used)

The space in the above example is a confined space because the actual Btu/Hr used is more than the maximum Btu/Hr the space can support. You must provide additional fresh air. Your options are as follows:

- A. Rework worksheet, adding the space of an adjoining room. If the extra space provides an unconfined space, remove door to adjoining room or add ventilation grills between rooms. See *Ventilation Air From Inside Building*.
- B. Vent room directly to the outdoors. See *Ventilation Air From Outdoors*, page 5.
- C. Install a lower Btu/Hr heater, if lower Btu/Hr size makes room unconfined.

If the actual Btu/Hr used is less than the maximum Btu/Hr the space can support, the space is an unconfined space. You will need no additional fresh air ventilation.

**⚠ WARNING:** If the area in which the heater may be operated is smaller than that defined as an unconfined space, provide adequate combustion and ventilation air by one of the methods described in the *National Fuel Gas Code, ANSI Z223.1, 1992, Section 5.3* or applicable local codes.

## VENTILATION AIR

### Ventilation Air From Inside Building

This fresh air would come from an adjoining unconfined space. When ventilating to an adjoining unconfined space, you must provide two permanent openings: one within 12" of the ceiling and one within 12" of the floor on the wall connecting the two spaces (see options 1 and 2, Figure 2 page 5). You can also remove door into adjoining room (see option 3, Figure 2). Follow the *National Fuel Gas Code NFPA 54/ANSI Z223.1, Section 5.3, Air for Combustion and Ventilation* for required size of ventilation grills or ducts.

**⚠ WARNING:** Rework worksheet, adding the space of the adjoining unconfined space. The combined spaces must have enough fresh air to supply all appliances in both spaces.

*Continued*

## AIR FOR COMBUSTION AND VENTILATION

*Continued*

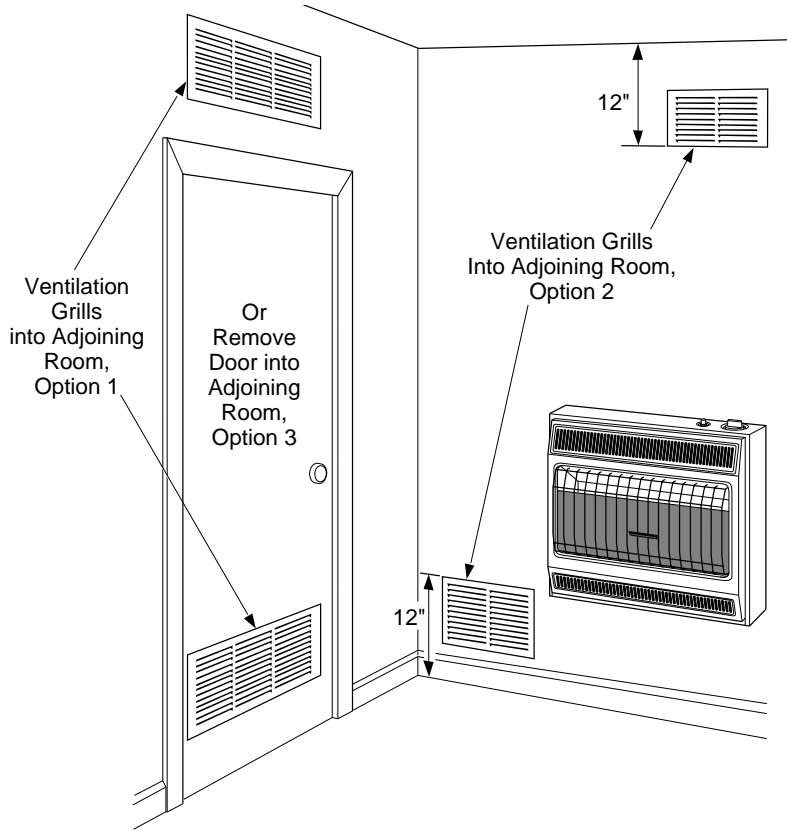
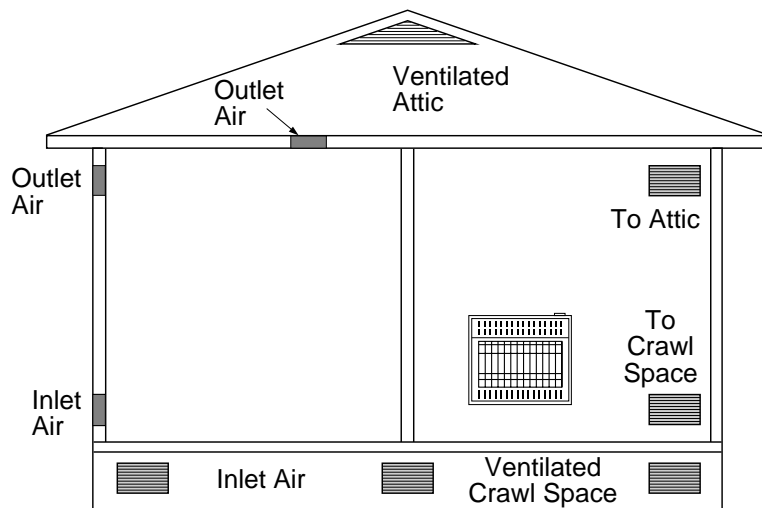

**Figure 2 - Ventilation Air from Inside Building**

### Ventilation Air From Outdoors

Provide extra fresh air by using ventilation grills or ducts. You must provide two permanent openings: one within 12" of the ceiling and one within 12" of the floor. Connect these items directly to the outdoors or spaces open to the outdoors. These spaces include attics and crawl spaces. Follow the *National Fuel Gas Code NFPA 54/ANSI Z223.1, Section 5.3, Air for Combustion and Ventilation* for required size of ventilation grills or ducts.

**IMPORTANT:** Do not provide openings for inlet or outlet air into attic if attic has a thermostat-controlled power vent. Heated air entering the attic will activate the power vent.



**Figure 3 - Ventilation Air from Outdoors**

# BLUE-FLAME CGP20, CGP20L AND RP30D VENT-FREE PROPANE/LP GAS HEATER

## INSTALLING TO WALL

**NOTICE: A qualified service person must install heater. Follow all local codes.**

## CHECK GAS TYPE

Use only propane/LP gas. If your gas supply is not propane/LP, do not install heater. Call dealer where you bought heater for proper type heater.

## INSTALLATION ITEMS

Before installing heater, make sure you have the items listed below.

- external regulator (supplied by installer, see page 8)
- piping (check local codes)
- sealant (resistant to propane/LP gas)
- manual shutoff valve \*
- ground joint union
- test gauge connection \* (see Figure 13, page 9)
- sediment trap
- tee joint
- pipe wrench

\* An A.G.A. design certified manual shutoff valve with 1/8" NPT tap is an acceptable alternative to test gauge connection. Purchase the optional A.G.A. design certified manual shutoff valve from your dealer. See *Accessories*, page 17.

## LOCATING HEATER

This heater is designed to be mounted on a wall.

**WARNING: Maintain the minimum clearances shown in Figure 4. If you can, provide greater clearances from floor, ceiling, and joining wall.**

You can locate model CGP20 and CGP20L on floor, away from a wall. An optional floor mounting stand is needed. Purchase the floor mounting stand from your dealer. See *Accessories*, page 17.

**WARNING: Never install the heater**

- in a bedroom or bathroom
- in a recreational vehicle
- where curtains, furniture, clothing, or other flammable objects are less than 36 inches from the front, top, or sides of the heater
- as a fireplace insert
- in high traffic areas
- in windy or drafty areas

**CAUTION: This heater creates warm air currents. These currents move heat to wall surfaces next to heater. Installing heater next to vinyl or cloth wall coverings or operating heater where impurities in the air (such as tobacco smoke) exist, may discolor walls.**

**IMPORTANT:** Vent-free heaters add moisture to the air. Although this is beneficial, installing heater in rooms without enough ventilation air may cause mildew to form from too much moisture. See *Air for Combustion and Ventilation*, pages 3 through 5.

**CAUTION: If you install the heater in a home garage**

- heater pilot and burner must be at least 18 inches above floor
- locate heater where moving vehicle will not hit it

For convenience and efficiency, install heater

- where there is easy access for operation, inspection, and service
- where strong wind gusts from an open door or garage door can not blow directly into heater.

An optional fan kit is available from your dealer. See *Accessories*, page 17. If planning to use fan, locate heater near an electrical outlet.

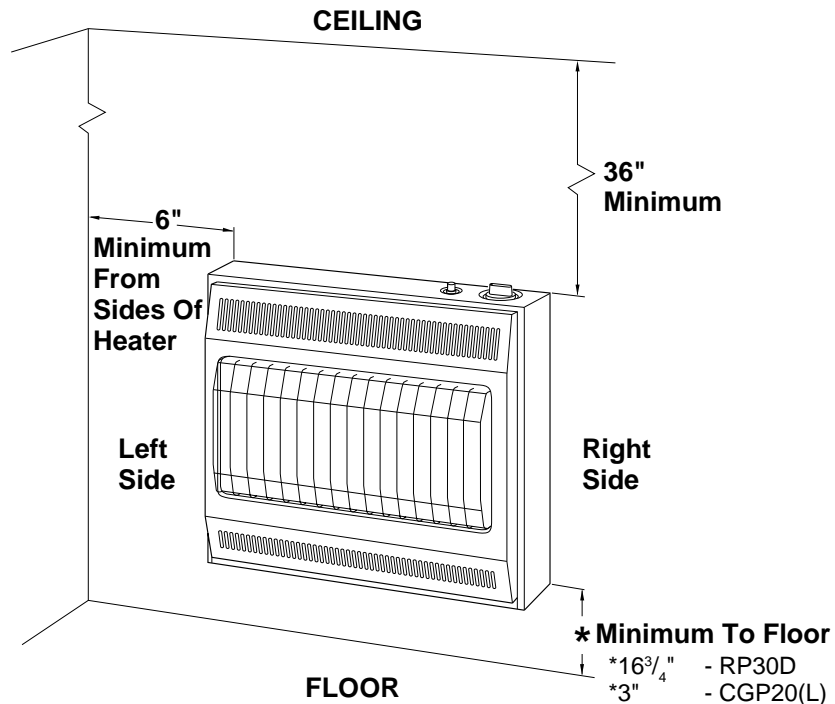

Figure 4 - Mounting Clearances As Viewed From Front of Heater

Continued

## INSTALLING TO WALL

*Continued*

## INSTALLING HEATER TO WALL

### Mounting Bracket

The mounting bracket is located on back panel of heater. It has been taped there for shipping. Remove mounting bracket from back panel.

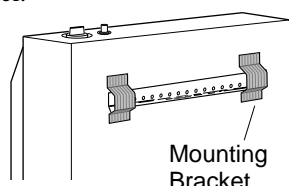

**Figure 5 - Mounting Bracket Location**

### Removing Front Panel Of Heater

1. Remove two screws near bottom corners of front panel.
2. Lift straight up on grill guard until it stops. Grill guard will slide up about 1/4".
3. Pull bottom of front panel forward, then down.
4. Remove cardboard packing from grill and glass (CGP20[L]) or heat shield (RP30D).

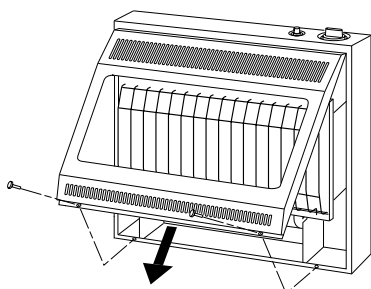

**Figure 6 - Removing Front Panel Of Heater**

### Methods For Attaching Mounting Bracket To Wall

Only use last hole on each end of mounting bracket to attach bracket to wall. These two holes are 16 inches apart from their centers. Attach mounting bracket to wall in one of two ways.

1. Attaching to wall stud
2. Attaching to wall anchor

**Attaching to wall stud:** This method provides the strongest hold. Insert mounting screws through mounting bracket and into wall studs.

**Attaching to wall anchor:** This method allows you to attach mounting bracket to hollow walls (wall areas between studs) or to solid walls (concrete or masonry).

Decide which method better suits your needs. Either method will provide a secure hold for the mounting bracket.

### Marking Screw Locations

1. Tape mounting bracket to wall where heater will be located. Make sure mounting bracket is level.
2. Mark screw locations on wall (see Figure 7).

**⚠ WARNING: Maintain minimum clearances shown in Figure 7. If you can, provide greater clearances from floor and joining wall.**

*Note:* Only mark last hole on each end of mounting bracket. Insert mounting screws through these holes only.

3. Remove tape and mounting bracket from wall.

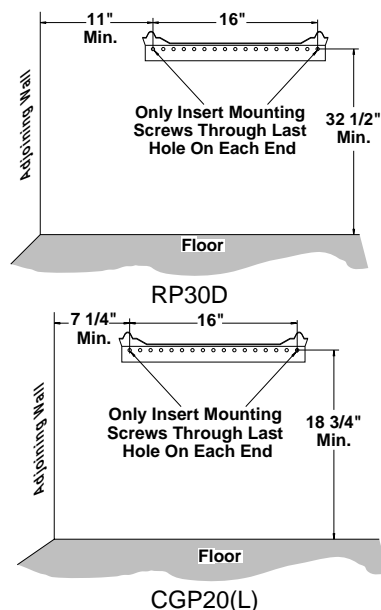

**Figure 7 - Mounting Bracket Clearances**

### Attaching Mounting Bracket To Wall

*Note:* Wall anchors, mounting screws, and spacers are in hardware package. The hardware package is provided with heater.

### Attaching to wall stud method

For attaching mounting bracket to wall studs

1. Drill holes at marked locations using 9/64" drill bit.
2. Place mounting bracket onto wall. Line up last hole on each end of bracket with holes drilled in wall.
3. Insert mounting screws through bracket and into wall studs.
4. Tighten screws until mounting bracket is firmly fastened to wall studs.

### Attaching to wall anchor method

For attaching mounting bracket to hollow walls (wall areas between studs) or solid walls (concrete or masonry)

1. Drill holes at marked locations using 5/16" drill bit. For solid walls (concrete or masonry), drill at least 1" deep.
2. Fold wall anchor as shown in Figure 8.

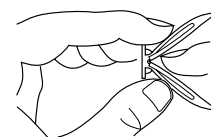
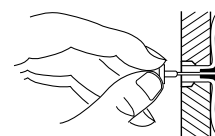

**Figure 8 - Folding Anchor**

3. Insert wall anchor (wings first) into hole. Tap anchor flush to wall.
4. For thin walls (1/2" or less), insert red key into wall anchor. Push red key to "pop" open anchor wings.

**IMPORTANT:** Do not hammer key!

For thick walls (over 1/2" thick) or solid walls, do not pop open wings.



**Figure 9 - Popping Open Anchor Wings For Thin Walls**

5. Place mounting bracket onto wall. Line up last hole on each end of bracket with wall anchors.
6. Insert mounting screws through bracket and into wall anchors.
7. Tighten screws until mounting bracket is firmly fastened to wall.

# BLUE-FLAME CGP20, CGP20L AND RP30D VENT-FREE PROPANE/LP GAS HEATER

## INSTALLING TO WALL

**Continued**

### Placing Heater On Mounting Bracket

1. Locate two horizontal slots on back panel of heater.
2. Place heater onto mounting bracket. Slide horizontal slots onto stand-out tabs on mounting bracket.

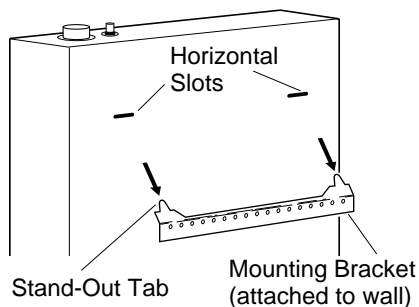

**Figure 10 - Mounting Heater Onto Mounting Bracket**

### Installing Bottom Mounting Screws

1. Locate two bottom mounting holes. These holes are near bottom on back panel of heater (see Figure 11).

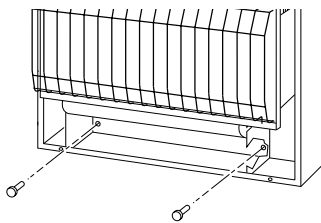

**Figure 11 - Installing Bottom Mounting Screws**

2. Mark screw locations on wall.
3. Remove heater from mounting bracket.
4. If installing bottom mounting screws into hollow or solid wall, install wall anchors. Follow steps 1 through 4 under *Attaching To Wall Anchor Method*, page 7.

If installing bottom mounting screw into wall stud, drill holes at marked locations using 9/64" drill bit.

5. Replace heater onto mounting bracket.
6. Place spacers between bottom mounting holes and wall anchor or drilled hole.

7. Hold spacer in place with one hand. With other hand, insert mounting screw through bottom mounting hole and spacer. Place tip of screw in opening of wall anchor or drilled hole.
8. Tighten both screws until heater is firmly secured to wall. Do not over tighten.

**Note:** Do not replace front panel at this time. Replace front panel after making gas connections and checking for leaks (see pages 8-9).

## CONNECTING TO GAS SUPPLY

**NOTICE: A qualified service person must connect heater to gas supply. Follow all local codes.**

**CAUTION: Never connect heater directly to the propane/LP supply. This heater requires an external regulator (not supplied). Install the external regulator between the heater and propane/LP supply.**

The installer must supply an external regulator. The external regulator will reduce incoming gas pressure. You must reduce incoming gas pressure to between 11 and 14 inches of water. If you do not reduce incoming gas pressure, heater regulator damage could occur. Install external regulator with the vent pointing down as shown in Figure 12. Pointing the vent down protects it from freezing rain or sleet.

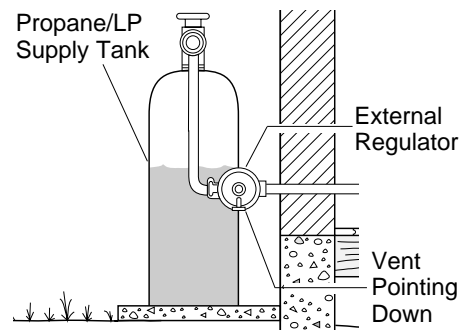

**Figure 12 - External Regulator with Vent Pointing Down**

**CAUTION: Use only new, black iron or steel pipe. Internally-tinned copper tubing may be used in certain areas. Check your local codes. Use pipe of 1/2" diameter or greater to allow proper gas volume to heater. If pipe is too small, undue loss of pressure will occur.**

### Typical Inlet Pipe Diameters

20,000 Btu/Hr models 3/8" or greater

30,000 Btu/Hr models 1/2" or greater

Installation must include a manual shutoff valve, union, and plugged 1/8" NPT tap. Locate NPT tap within reach for test gauge hook up. NPT tap must be upstream from heater (see Figure 13, page 9).

Apply pipe joint sealant lightly to male threads. This will prevent excess sealant from going into pipe. Excess sealant in pipe could result in clogged heater valves.

**CAUTION: Use pipe joint sealant that is resistant to liquid petroleum (LP) gas.**

Install sediment trap in supply line as shown in Figure 13, page 9. Locate sediment trap where it is within reach for cleaning. Locate sediment trap where trapped matter is not likely to freeze. A sediment trap traps moisture and contaminants. This keeps them from going into heater controls. If sediment trap is not installed or is installed wrong, heater may not run properly.

*Continued*



## CONNECTING TO GAS SUPPLY

### Continued

**IMPORTANT:** Hold pressure regulator with wrench when connecting it to gas piping and/or fittings.

\* An A.G.A. design certified manual shutoff valve with 1/8" NPT tap is an acceptable alternative to test gauge connection. Purchase the optional A.G.A. design certified manual shutoff valve from your dealer. See *Accessories*, page 17.

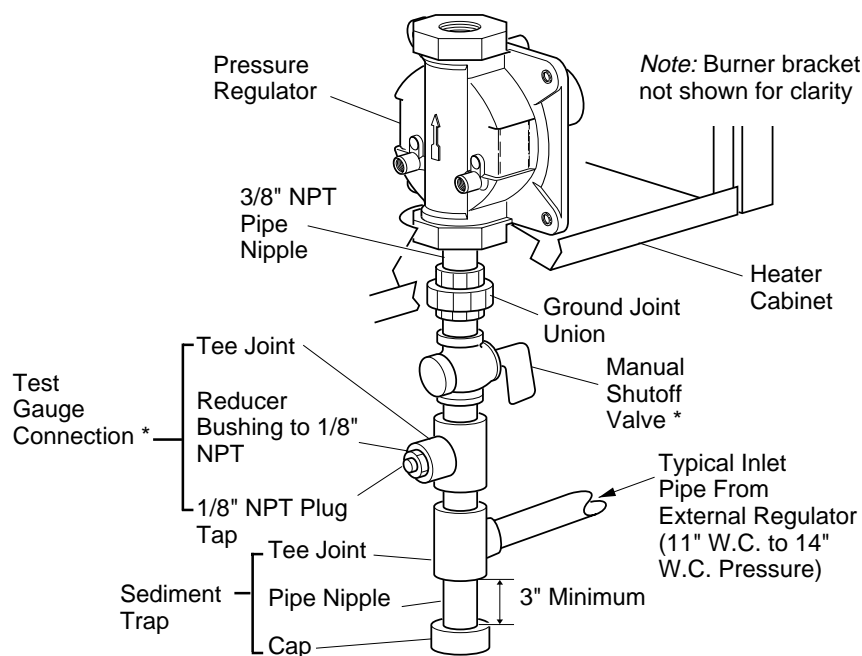

Figure 13 - Gas Connection

## CHECKING GAS CONNECTIONS

**WARNING:** Test all gas piping and connections for leaks after installing or servicing. Correct all leaks at once.

**WARNING:** Never use an open flame to check for a leak. Apply a mixture of liquid soap and water to all joints. Bubbles forming show a leak. Correct all leaks at once.

**CAUTION:** Make sure external regulator has been installed between propane/LP supply and heater. See guidelines under *Connecting to Gas Supply*.

2. Cap off open end of gas pipe where manual shutoff valve was connected.
3. Pressurize supply piping system by either using compressed air or opening propane/LP supply tank valve.
4. Check all joints of gas supply piping system. Apply mixture of liquid soap and water to gas joints. Bubbles forming show a leak.
5. Correct all leaks at once.
3. Check all joints from propane/LP supply tank to manual shutoff valve (see Figure 15, page 10). Apply mixture of liquid soap and water to gas joints. Bubbles forming show a leak.
4. Correct all leaks at once.

### Test Pressures Equal To or Less Than 1/2 PSIG

1. Close manual shutoff valve (see Figure 14).

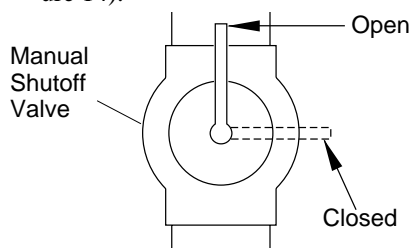

Figure 14 - Manual Shutoff Valve

## PRESSURE TESTING GAS SUPPLY PIPING SYSTEM

### Test Pressures In Excess Of 1/2 PSIG

1. Disconnect heater and its individual manual shutoff valve from gas supply piping system. Pressures in excess of 1/2 PSIG will damage heater regulator.

2. Pressurize supply piping system by either using compressed air or opening propane/LP supply tank valve.

## PRESSURE TESTING HEATER GAS CONNECTIONS

1. Open manual shutoff valve (see Figure 14).
2. Open propane/LP supply tank valve.
3. Make sure control knob of heater is in the OFF position.
4. Check all joints from manual shutoff valve to control valve (see Figure 15, page 10). Apply mixture of liquid soap and water to gas joints. Bubbles forming show a leak.
5. Correct all leaks at once.
6. Light heater (see *Operating Heater*, pages 10 and 11). Check the rest of the internal joints for leaks.
7. Turn off heater (see *To Turn Off Gas to Appliance*, page 11).
8. Replace front panel.

Continued

# BLUE-FLAME CGP20, CGP20L AND RP30D VENT-FREE PROPANE/LP GAS HEATER

## CHECKING GAS CONNECTIONS

*Continued*

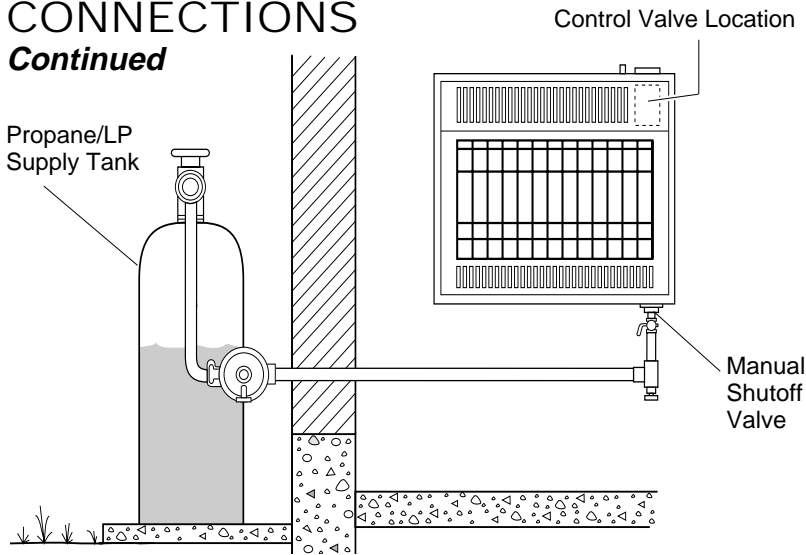

Figure 15 - Checking Gas Joints

## OPERATING HEATER

**FOR YOUR SAFETY  
READ BEFORE  
LIGHTING**

**⚠ WARNING:** If you do not follow these instructions exactly, a fire or explosion may result causing property damage, personal injury or loss of life.

- This appliance has a pilot which must be lighted by hand. When lighting the pilot, follow these instructions exactly.
- BEFORE LIGHTING** smell all around the appliance area for gas. Be sure to smell next to the floor because some gas is heavier than air and will settle on the floor.

### WHAT TO DO IF YOU SMELL GAS

- Do not try to light any appliance.
- Do not touch any electric switch; do not use any phone in your building.
- Immediately call your gas supplier from a neighbor's phone. Follow the gas supplier's instructions.
- If you cannot reach your gas supplier, call the fire department.

- Use only your hand to push in or turn the gas control knob. Never use tools. If the knob will not push in or turn by hand, don't try to repair it, call a qualified service technician or gas supplier. Force or attempted repair may result in a fire or explosion.
- Do not use this appliance if any part has been under water. Immediately call a qualified service technician to inspect the appliance and to replace any part of the control system and any gas control which has been under water.

## LIGHTING INSTRUCTIONS

- STOP!** Read the safety information above.
- Make sure manual shutoff valve is fully open.
- Turn control knob clockwise to the OFF position.

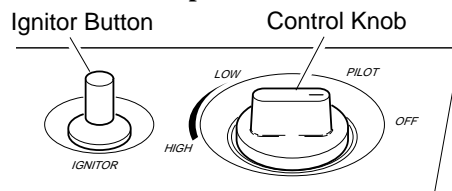

Figure 16 - Control Knob In The OFF Position

- Wait five (5) minutes to clear out any gas. Then smell for gas, including near the floor. If you smell gas, **STOP!** Follow "B" in the safety information in the first column. If you don't smell gas, go to the next step.

- Press in control knob and turn counterclockwise to the PILOT position. Keep control knob pressed in for five (5) seconds (see Figure 16).

**Note:** You may be running this heater for the first time after hooking up to gas supply. If so, the control knob may need to be pressed in for 30 seconds. This will allow air to bleed from the gas system.

- If control knob does not pop up when released, contact a qualified service person or gas supplier for repairs.

- With control knob pressed in, push down and release ignitor button. This will light pilot. The pilot is attached to the front of burner. The burner and pilot are located behind the heat shield. If needed, keep pressing ignitor button until pilot lights.

**Note:** If pilot does not stay lit, refer to *Troubleshooting*, pages 12 through 14. Also contact a qualified service person or gas supplier for repairs. Until repairs are made, light pilot with match. To light pilot with match, see *Manual Lighting Procedure*, page 11.

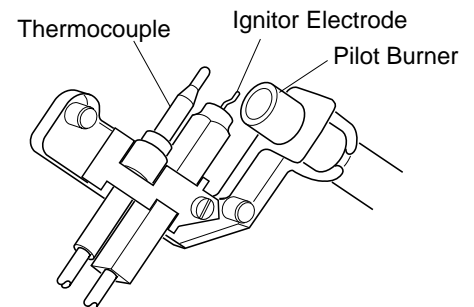

Figure 17 - Pilot

- Keep control knob pressed in for 30 seconds after lighting pilot. After 30 seconds, release control knob.

**Note:** If pilot goes out, repeat steps 3 through 7.

*Continued*

## OPERATING HEATER

### Continued

- Turn control knob counterclockwise to the **LOW** position. The main burner should light. Set control knob to any heat level between **HIGH** and **LOW**. To turn control knob from **LOW** to a higher setting, press in the control knob and turn counterclockwise.

**Note:** Both **HIGH** and **LOW** are locked positions. You must press in control knob before turning it from these positions.

**CAUTION:** Do not try to adjust heating levels by using the manual shutoff valve.

### TO TURN OFF GAS TO APPLIANCE

#### Shutting Off Heater

- Turn control knob clockwise to the **PILOT** position.
- Press in control knob and turn clockwise to the **OFF** position.
- Turn off all electric power to the appliance if service is to be performed.

#### Shutting Off Burner Only (pilot stays lit)

- Turn control knob clockwise to the **PILOT** position.

### MANUAL LIGHTING PROCEDURE

- Remove front panel (see Figure 6, page 7).
- Follow steps 1 through 5 under *Lighting Instructions*, page 10.
- With control knob pressed in, strike match. Hold match to pilot until pilot lights.
- Keep control knob pressed in for 30 seconds after lighting pilot. After 30 seconds, release control knob.
- Replace front panel.

## INSPECTING BURNER

Check pilot flame pattern and burner flame pattern often.

### PILOT FLAME PATTERN

Figure 18 shows a correct pilot flame pattern. Figure 19 shows an incorrect pilot flame pattern. The incorrect pilot flame is not touching the thermocouple. This will cause the thermocouple to cool. When the thermocouple cools, the heater will shut down.

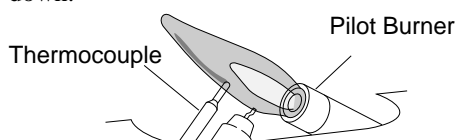

Figure 18 - Correct Pilot Flame Pattern

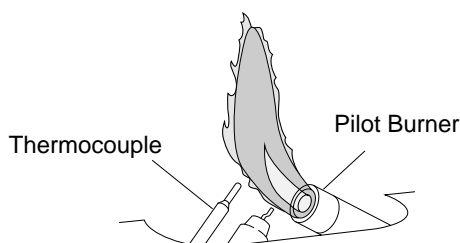

Figure 19 - Incorrect Pilot Flame Pattern

If pilot flame pattern is incorrect, as shown in Figure 19

- turn heater off (see *To Turn Off Gas to Appliance*.)
- see *Troubleshooting*, pages 12 through 14

### BURNER FLAME PATTERN

Figure 20 shows a correct burner flame pattern. Figure 21 shows an incorrect burner flame pattern. The incorrect burner flame pattern shows yellow tipping of the flame. It also shows the flame higher than 1/2 the heat shield height.

**WARNING:** If yellow tipping occurs, your heater could produce increased levels of carbon monoxide. If burner flame pattern shows yellow tipping, follow instructions at bottom of this page.

**NOTICE:** Do not mistake orange flames with yellow tipping. Dirt or other fine particles enter the heater and burn causing brief patches of orange flame.

If burner flame pattern is incorrect, as shown in Figure 21

- turn heater off (see *To Turn Off Gas to Appliance*)
- see *Troubleshooting*, pages 12 through 14

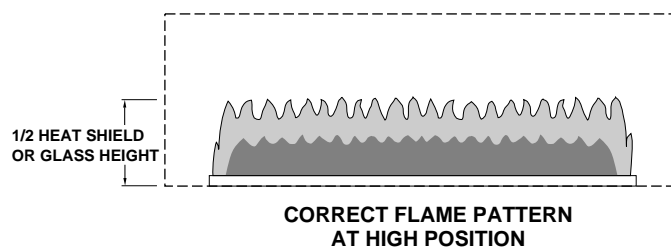

Figure 20 - Correct Burner Flame Pattern

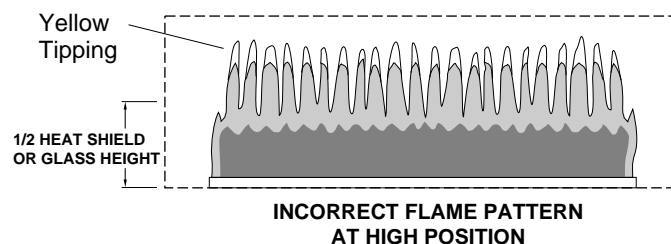

Figure 21 - Incorrect Burner Flame Pattern

# BLUE-FLAME CGP20, CGP20L AND RP30D VENT-FREE PROPANE/LP GAS HEATER

## TROUBLESHOOTING

*Note:* All troubleshooting items are listed in order of operation.

**⚠ WARNING:** Turn off and unplug heater and let cool before servicing. Only a qualified service person should service and repair heater.

**⚠ CAUTION:** Never use a wire, needle, or similar object to clean ODS/pilot. This can damage ODS/pilot unit.

OBSERVED PROBLEM	POSSIBLE CAUSE	REMEDY
When ignitor button is pressed, there is no spark at ODS/pilot	<ol style="list-style-type: none"> <li>Ignitor electrode positioned wrong</li> <li>Ignitor electrode broken</li> <li>Ignitor electrode not connected to ignitor cable</li> <li>Ignitor cable pinched or wet</li> <li>Broken ignitor cable</li> <li>Bad piezo ignitor</li> </ol>	<ol style="list-style-type: none"> <li>Replace ignitor</li> <li>Replace ignitor</li> <li>Reconnect ignitor cable</li> <li>Free ignitor cable if pinched by any metal or tubing. Keep ignitor cable dry</li> <li>Replace ignitor cable</li> <li>Replace piezo ignitor</li> </ol>
When ignitor button is pressed, there is spark at ODS/pilot but no ignition	<ol style="list-style-type: none"> <li>Gas supply turned off or manual shutoff valve closed</li> <li>Control knob not in PILOT position</li> <li>Control knob not pressed in while in PILOT position</li> <li>Air in gas lines when installed</li> <li>Depleted gas supply</li> <li>ODS/pilot is clogged</li> <li>Gas regulator setting is not correct</li> </ol>	<ol style="list-style-type: none"> <li>Turn on gas supply or open manual shutoff valve</li> <li>Turn control knob to PILOT position</li> <li>Press in control knob while in PILOT position</li> <li>Continue holding down control knob. Repeat igniting operation until air is removed</li> <li>Contact local propane/LP gas company</li> <li>Clean ODS/pilot (see <i>Cleaning and Maintenance</i>, page 15) or replace ODS/pilot assembly</li> <li>Replace gas regulator</li> </ol>
ODS/pilot lights but flame goes out when control knob is released	<ol style="list-style-type: none"> <li>Control knob not fully pressed in</li> <li>Control knob not pressed in long enough</li> <li>Manual shutoff valve not fully open</li> <li>Thermocouple connection loose at control valve</li> <li>Pilot flame not touching thermocouple, which allows thermocouple to cool, causing pilot flame to go out. This problem could be caused by one or both of the following:                     <ol style="list-style-type: none"> <li>Low gas pressure</li> <li>Dirty or partially clogged ODS/pilot</li> </ol> </li> <li>Thermocouple damaged</li> <li>Control valve damaged</li> </ol>	<ol style="list-style-type: none"> <li>Press in control knob fully</li> <li>After ODS/pilot lights, keep control knob pressed in 30 seconds</li> <li>Fully open manual shut-off valve</li> <li>Hand tighten until snug, then tighten 1/4 turn more</li> <li> <ol style="list-style-type: none"> <li>Contact local propane/LP gas company</li> <li>Clean ODS/pilot (see <i>Cleaning and Maintenance</i>, page 15) or replace ODS/pilot assembly</li> </ol> </li> <li>Replace thermocouple</li> <li>Replace control valve</li> </ol>
Burner does not light after ODS/pilot is lit	<ol style="list-style-type: none"> <li>Burner orifice is clogged</li> <li>Burner orifice diameter is too small</li> <li>Inlet gas pressure is too low</li> </ol>	<ol style="list-style-type: none"> <li>Clean burner (see <i>Cleaning and Maintenance</i>, page 15) or replace burner orifice</li> <li>Replace burner orifice</li> <li>Contact local propane/LP gas company</li> </ol>

*Continued*

# OWNER'S MANUAL

## TROUBLESHOOTING

*Continued*

<b>OBSERVED PROBLEM</b>	<b>POSSIBLE CAUSE</b>	<b>REMEDY</b>
Delayed ignition of burner	<ol style="list-style-type: none"><li>1. Manifold pressure is too low</li><li>2. Burner orifice is clogged</li></ol>	<ol style="list-style-type: none"><li>1. Contact local propane/LP gas company</li><li>2. Clean burner (see <i>Cleaning and Maintenance</i>, page 15) or replace burner orifice</li></ol>
Burner backfiring during combustion	<ol style="list-style-type: none"><li>1. Burner orifice is clogged or damaged</li><li>2. Inlet gas pressure is too low</li><li>3. Burner damaged</li><li>4. Gas regulator defective</li></ol>	<ol style="list-style-type: none"><li>1. Clean burner (see <i>Cleaning and Maintenance</i>, page 15) or replace burner orifice</li><li>2. Contact local propane/LP gas company</li><li>3. Replace burner</li><li>4. Replace gas regulator</li></ol>
Yellow flame during burner combustion	<ol style="list-style-type: none"><li>1. Not enough air</li><li>2. Inlet gas pressure is too low</li><li>3. Gas regulator defective</li></ol>	<ol style="list-style-type: none"><li>1. Check burner for dirt and debris. If found, clean burner (see <i>Cleaning and Maintenance</i>, page 15)</li><li>2. Contact local propane/LP gas company</li><li>3. Replace gas regulator</li></ol>
Slight smoke or odor during initial operation	<ol style="list-style-type: none"><li>1. Residues from manufacturing processes</li></ol>	<ol style="list-style-type: none"><li>1. Problem will stop after a few hours of operation</li></ol>
Heater produces a whistling noise when burner is lit	<ol style="list-style-type: none"><li>1. Turning control knob to HIGH position when burner is cold</li><li>2. Air in gas line</li><li>3. Air passageways on heater blocked</li><li>4. Dirty or partially clogged burner orifice</li></ol>	<ol style="list-style-type: none"><li>1. Turn control knob to LOW position and let warm up for a minute</li><li>2. Operate burner until air is removed from line. Have gas line checked by local propane/LP gas company</li><li>3. Observe minimum installation clearances (see Figure 4, page 6)</li><li>4. Clean burner (see <i>Cleaning and Maintenance</i>, page 15) or replace burner orifice</li></ol>

*Continued*

# BLUE-FLAME CGP20, CGP20L AND RP30D VENT-FREE PROPANE/LP GAS HEATER

## TROUBLESHOOTING

*Continued*



**WARNING: If you smell gas**

- Shut off gas supply.
- Do not try to light any appliance.
- Do not touch any electrical switch; do not use any phone in your building.
- Immediately call your gas supplier from a neighbor's phone. Follow the gas supplier's instructions.
- If you cannot reach your gas supplier, call the fire department.

**IMPORTANT:** Operating heater where impurities in air exist may create odors. Cleaning supplies, paint, paint remover, cigarette smoke, cements and glues, new carpet or textiles, etc., create fumes. These fumes may mix with combustion air and create odors.

OBSERVED PROBLEM	POSSIBLE CAUSE	REMEDY
Heater produces a clicking/ticking noise just after burner is lit or shut off	1. Metal expanding while heating or contracting while cooling	1. This is common with most heaters. If noise is excessive, contact qualified service person
Heater produces unwanted odors	1. Heater burning vapors from paint, solvents, glues, etc. See <b>IMPORTANT</b> statement above 2. Low fuel supply 3. Gas leak. <b>See Warning statement at top of page</b>	1. Ventilate room. Stop using odor causing products while heater is running 2. Refill supply tank 3. Locate and correct all leaks (see <i>Checking Gas Connections</i> , pages 9 and 10)
Heater shuts off in use (ODS operates)	1. Not enough fresh air is available 2. Low line pressure 3. ODS/pilot is partially clogged	1. Open window and/or door for ventilation 2. Contact local propane/LP gas company 3. Clean ODS/pilot (see <i>Cleaning and Maintenance</i> , page 15)
Gas odor even when control knob is in OFF position	1. Gas leak. <b>See Warning statement at top of page</b> 2. Control valve defective	1. Locate and correct all leaks (see <i>Checking Gas Connections</i> , pages 9 and 10) 2. Replace control valve
Gas odor during combustion	1. Foreign matter between control valve and burner 2. Gas leak. <b>See Warning statement at top of page</b>	1. Take apart gas tubing and remove foreign matter 2. Locate and correct all leaks (see <i>Checking Gas Connections</i> , pages 9 and 10)
Moisture/condensation noticed on windows	1. Not enough combustion/ventilation air.	1. Refer to <i>Air for Combustion and Ventilation</i> requirements (page 3)

# OWNER'S MANUAL

## CLEANING AND MAINTENANCE

**⚠ WARNING: Turn off heater and let cool before cleaning.**

**⚠ CAUTION: You must keep control areas, burner, and circulating air passageways of heater clean. Inspect these areas of heater before each use. Have heater inspected yearly by a qualified service person. Heater may need more frequent cleaning due to excessive lint from carpeting and bedding material, sawdust, cobwebs, etc.**

### ODS/PILOT AND BURNER

- Use a vacuum cleaner, pressurized air, or small, soft bristled brush to clean.

### CABINET

#### Air Passageways

- Use a vacuum cleaner or pressurized air to clean.

#### Exterior

- Use a soft cloth dampened with a mild soap and water mixture. Wipe the cabinet to remove dust.

## TECHNICAL SERVICE

You may have further questions about installation, operation, or troubleshooting. If so, contact DESA International's Technical Service Department at 1-800-323-5190.

## SPECIFICATIONS

	<b>RP30D</b>	<b>CGP20(L)</b>
Btu (Variable)	15,000/30,000	10,000/20,000
Type Gas	Propane/LP Only	Propane/LP Only
Ignition	Piezo	Piezo
Pressure Regulator Setting	8" W.C.	8" W.C.
Inlet Gas Pressure (inches of water)		
Maximum	14"	14"
Minimum	11"	11"
Dimensions, Inches (H x W x D)		
Heater	23.5 x 25.9 x 8.0	23.5 x 18.5 x 8.0
Carton	26 x 27.75 x 9.63	26 x 20.5 x 9.63
Weight (pounds)		
Heater	30	22
Shipping	35	27

## SERVICE HINTS

### When gas pressure is too low

- pilot will not stay lit
- burner will have delayed ignition
- heater will not produce specified heat
- propane/LP gas supply may be low

### When gas quality is bad

- pilot will not stay lit
- burner will produce flames and soot
- heater will backfire when lit

You may feel your gas pressure is too low or gas quality is bad. If so, contact your local propane/LP gas supplier.

# BLUE-FLAME CGP20, CGP20L AND RP30D VENT-FREE PROPANE/LP GAS HEATER

---

## REPLACEMENT PARTS

*Note:* Use only original replacement parts. This will protect your warranty coverage for parts replaced under warranty.

### Parts Under Warranty

Contact authorized dealers of this product. If they can't supply original replacement part(s), either contact your nearest Parts Central (see below) or call DESA International's Technical Service Department at 1-800-323-5190.

When calling, have ready

- your name
- your address
- model number of your heater
- how heater was malfunctioning
- type of gas used (propane/LP or natural gas)
- purchase date

Usually, we will ask you to return the defective part to the factory.

### Parts Not Under Warranty

Contact authorized dealers of this product. If they can't supply original replacement part(s), either contact your nearest Parts Central (see below) or call DESA International's Parts Department at 1-800-972-7879 for referral information.

When calling, have ready

- model number of your heater
- the replacement part number

## PARTS CENTRALS

These Parts Centrals are privately owned businesses. They have agreed to support our customer's needs by providing original replacement parts and accessories. When calling a Parts Central, ask for the Parts Department.

### Baltimore Electric

1348 Dixwell Avenue  
Hamden, CT 06514  
1-800-397-7553  
203-248-7553  
Parts Department

### Portable Heater Parts

342 N. County Rd. 400 East  
Valparaiso, IN 46383  
All States  
219-462-7441  
1-800-362-6951  
Parts Department

### FBD

1349 Adams Street  
Bowling Green, KY 42103  
502-846-1199  
1-800-654-8534  
Fax: 1-800-846-0090

### Four Flags Power Products

1115 Stateline Road  
Niles, MI 49120  
616-684-2697  
1-800-268-4983  
Parts Only

### Master Parts Distributor

1184 Wilson NW  
Grand Rapids, MI 49504  
US 1-800-446-1446  
616-791-0505  
Fax: 1-616-791-8270  
Parts Department

### Washer Equipment Co.

1715 Main Street  
Kansas City, MO 64108  
KS, MO, AR  
816-842-3911  
Parts Department

### East Coast Energy Products

707 Broadway  
W. Long Branch, NJ 07764  
908-870-8809  
1-800-755-8809  
Parts Department

### Tarantin Tank Co.

P.O. Box 6129  
Freehold, NJ 07728  
908-780-9340  
1-800-922-0724  
Parts Department

### Dayton Hardware

P.O. Box 275  
North Dayton Station  
Dayton, OH 45404  
All States  
513-258-3721  
OH 1-800-762-3426  
Parts Department

### Halco Enterprises

208 Carter Drive, Unit 21  
West Chester, PA 19382  
610-430-7717  
US 1-800-368-0803  
Parts Department

### Laporte's Parts & Service

2444 North 5th Street  
Hartsville, SC 29550  
803-332-0191  
Parts Department

### Cans Unlimited, Inc.

P.O. Box 645  
Taylor, SC 29687  
All States  
803-879-3009  
1-800-845-5301



## ACCESSORIES

Purchase these heater accessories from your local dealer. If they can not supply these accessories, either contact your nearest Parts Central (see page 16) or call DESA International's Parts Department at 1-800-972-7879 for referral information. You can also write to the address listed on the back page of this manual.

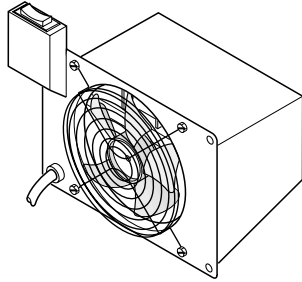

### FAN KITS - GA3100A AND GA3200TA

For all models. Provides better heat distribution. Makes heater more efficient. Complete installation and operating instructions included.

Manually controlled - GA3100A. Includes ON/OFF switch.

Thermostatically controlled - GA3200TA. Includes three settings: ON/OFF/AUTO.

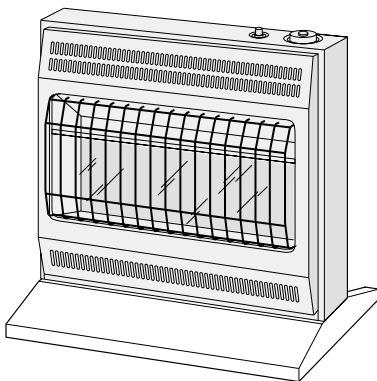

### FLOOR MOUNTING STAND 20,000 Btu/Hr Models CGP20L - GA4500L - Ivory CGP20 - GA4500 - Earthtone

For locating heater on the floor, away from a wall. Complete installation instructions included.

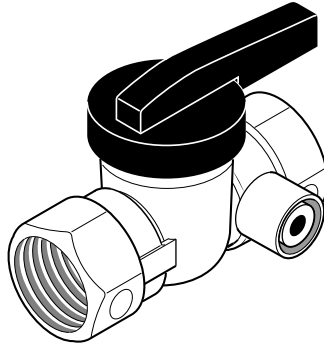

### MANUAL SHUTOFF VALVE - GA5010

For all models. Manual shutoff valve with 1/8" NPT tap.

# BLUE-FLAME CGP20, CGP20L AND RP30D VENT-FREE PROPANE/LP GAS HEATER

## ILLUSTRATED PARTS BREAKDOWN

### RP30D

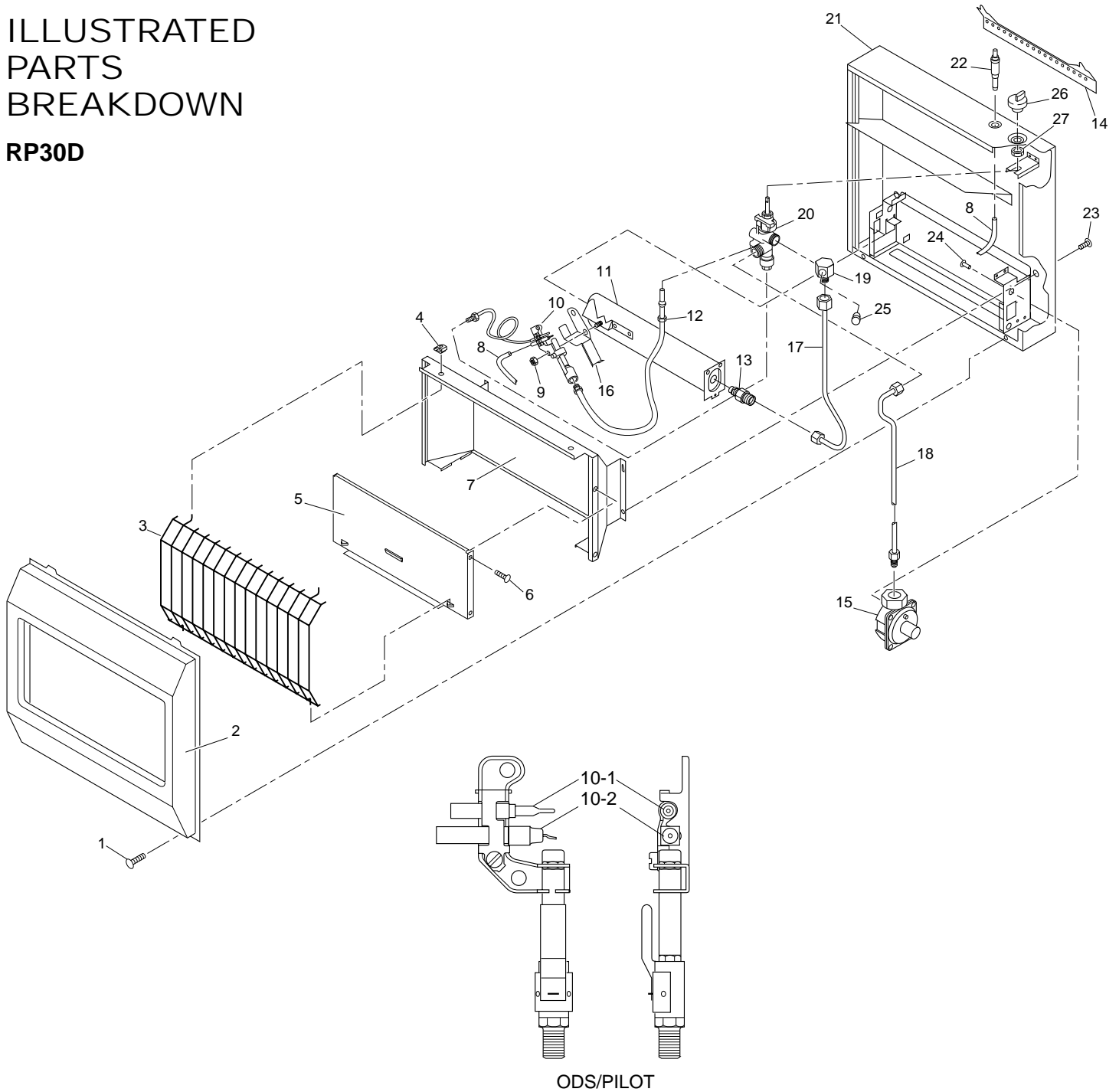

# OWNER'S MANUAL

## PARTS LIST

This list contains replaceable parts used in your heater. When ordering parts, follow the instructions listed under *Replacement Parts* on page 16 of this manual.

### RP30D

KEY NO.	PART NUMBER	DESCRIPTION	QTY.
1	098304-01	Screw, #10 x 3/8"	2
2	098345-01AC	Front Panel	1
3	103476-02	Grill Guard	1
4	101108-01	Clip, Grill Guard	2
5	099001-01BR	Heat Shield	1
6	M11084-26	Screw, #10 x 3/8"	4
7	098352-02BR	Deflector Unit	1
8	098271-03	Ignitor Cable	1
9	098249-01	Nut, M5	2
10	099059-04	ODS/Pilot, L.P.	1
10-1	098514-01	Thermocouple	1
10-2	098594-01	Ignitor Electrode	1
11	103447-01	Burner	1
12	099387-05	3/16" Pilot Tubing	1
13	103845-03	Injector	1
14	099066-01	Mounting Bracket	1
15	099415-06	Pressure Regulator	1
16	099553-01	Pilot Shield	1
17	103570-01	3/8" Outlet (Burner) Tubing	1
18	103572-01	3/8" Inlet Tubing	1
19	100068-01	Pressure Tap Fitting	1
20	100047-02	Control Valve	1
21	098529-04	Cabinet	1
22	097159-04	Piezo Ignitor	1
23	M11084-26	Screw, #10 x 3/8"	2
24	M11084-38	Screw, #8 x 3/8"	2
25	098276-01	1/8" NPT Plug	1
26	098354-01	Control Knob	1
27	098508-01	Valve Retainer Nut	1
<b>PARTS AVAILABLE — NOT SHOWN</b>			
	098306-02	Control Position Decal	1
	099261-02	Operating Instructions Decal	1
	100642-01	Assembly, Hardware	1

# BLUE-FLAME CGP20, CGP20L AND RP30D VENT-FREE PROPANE/LP GAS HEATER

## ILLUSTRATED PARTS BREAKDOWN

**CGP20**

**CGP20L**

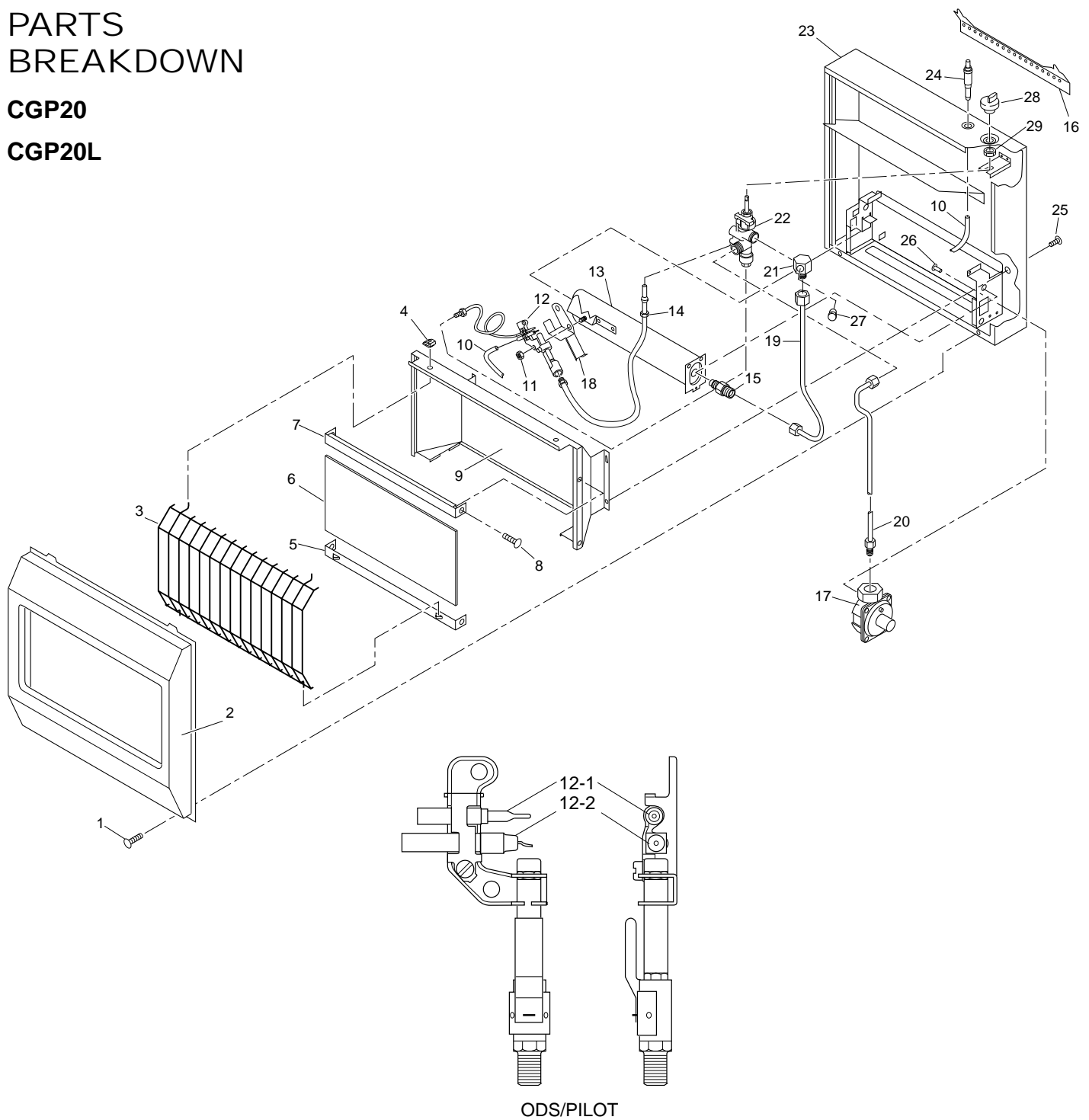

# OWNER'S MANUAL

## PARTS LIST

This list contains replaceable parts used in your heater. When ordering parts, follow the instructions listed under *Replacement Parts* on page 16 of this manual.

### CGP20

### CGP20L

KEY NO.	PART NUMBER	DESCRIPTION	QTY.
1	098304-01	Screw, #10 x 3/8"	2
2	098742-03	Front Panel (CGN20)	1
	098742-19	Front Panel, Ivory (CGN20L)	1
3	103476-01	Grill Guard	1
4	101108-01	Grill Guard Clip	2
5	098533-04AA	Bottom Glass Retainer	1
6	098260-09	Glass Panel	1
7	098532-04AA	Top Glass Retainer	1
8	M11084-26	Screw, #10 x 3/8"	4
9	098352-04BR	Deflector Unit	1
10	098271-03	Ignitor Cable	1
11	098249-01	Nut, M5	2
12	099059-04	ODS/Pilot Assembly	1
12-1	098514-01	Thermocouple	1
12-2	098594-01	Ignitor Electrode	1
13	103446-01	Burner	1
14	099387-05	3/16" Pilot Tubing	1
15	103845-01	Injector	1
16	099066-01	Mounting Bracket	1
17	099415-06	Pressure Regulator	1
18	099553-01	Pilot Shield	1
19	103570-01	3/8" Outlet (Burner) Tubing	1
20	103572-01	3/8" Inlet Tubing	1
21	100068-01	Pressure Tap Fitting	1
22	100047-04	Control Valve	1
23	098529-06	Cabinet, Woodgrain (CGN20)	1
	098529-05	Cabinet, Ivory (CGN20L Only)	1
24	097159-04	Piezo Ignitor	1
25	M11084-26	Screw, #10 x 3/8"	2
26	M11084-38	Screw, #8 x 3/8"	2
27	098276-01	1/8" NPT Plug	1
28	098354-01	Control Knob	1
29	098508-01	Valve Retainer Nut	1
<b>PARTS AVAILABLE — NOT SHOWN</b>			
	098306-02	Control Position Decal	1
	099491-07	Operating Instructions Decal	1
	100642-01	Assembly, Hardware	1





# WARRANTY INFORMATION

KEEP THIS WARRANTY

Model _____
Serial No. _____
Date Purchased _____

Always specify model and serial numbers when communicating with the factory.

We reserve the right to amend these specifications at any time without notice. The only warranty applicable is our standard written warranty. We make no other warranty, expressed or implied.

## LIMITED WARRANTY COMFORT GLOW VENT-FREE HEATERS

DESA International warrants this product to be free from defects in materials and components for two (2) years from the date of first purchase, provided that the product has been properly installed, operated and maintained in accordance with all applicable instructions. To make a claim under this warranty the Bill of Sale or cancelled check must be presented.

This warranty is extended only to the original retail purchaser. This warranty covers only the cost of part(s) required to restore this heater to proper operating condition. Warranty part(s) MUST be obtained through authorized dealers of this product and/or DESA International who will provide original factory replacement parts. Failure to use original factory replacement parts voids this warranty. The heater MUST be installed by a qualified installer in accordance with all local codes and instructions furnished with the unit.

This warranty does not apply to parts that are not in original condition because of normal wear and tear, or parts that fail or become damaged as a result of misuse, accidents, lack of proper maintenance or defects caused by improper installation. Travel, diagnostic cost, labor, transportation and any and all such other costs related to repairing a defective heater will be the responsibility of the owner.

TO THE FULL EXTENT ALLOWED BY THE LAW OF THE JURISDICTION THAT GOVERNS THE SALE OF THE PRODUCT; THIS EXPRESS WARRANTY EXCLUDES ANY AND ALL OTHER EXPRESSED WARRANTIES AND LIMITS THE DURATION OF ANY AND ALL IMPLIED WARRANTIES, INCLUDING WARRANTIES OF MERCHANTABILITY AND FITNESS FOR A PARTICULAR PURPOSE TO TWO (2) YEARS FROM THE DATE OF FIRST PURCHASE; AND DESA INTERNATIONAL'S LIABILITY IS HEREBY LIMITED TO THE PURCHASE PRICE OF THE PRODUCT AND DESA INTERNATIONAL SHALL NOT BE LIABLE FOR ANY OTHER DAMAGES WHATSOEVER INCLUDING INDIRECT, INCIDENTAL OR CONSEQUENTIAL DAMAGES.

Some states do not allow a limitation on how long an implied warranty lasts or an exclusion or limitation of incidental or consequential damages, so the above limitation on implied warranties, or exclusion or limitation on damages may not apply to you.

This warranty gives you specific legal rights, and you may also have other rights that vary from state to state.

For information about this warranty write:

**DESA**  
**INTERNATIONAL**

2701 Industrial Drive  
P.O. Box 90004  
Bowling Green, KY 42102-9004



103569 01  
NOT A UPC