

Elo Entuitive Touchmonitor User Guide

15" LCD Rear Mount Touchmonitor

ET1546L-XXWA-X Series



Revision B

P/N 008593

Elo TouchSystems, Inc.

**1-800-ELOTOUCH
www.elotouch.com**



Copyright © 2005 Elo TouchSystems Inc. All Rights Reserved.

No part of this publication may be reproduced, transmitted, transcribed, stored in a retrieval system, or translated into any language or computer language, in any form or by any means, including, but not limited to, electronic, magnetic, optical, chemical, manual, or otherwise without prior written permission of Elo TouchSystems.

Disclaimer

The information in this document is subject to change without notice. Elo TouchSystems makes no representations or warranties with respect to the contents hereof, and specifically disclaims any implied warranties of merchantability or fitness for a particular purpose. Elo TouchSystems reserves the right to revise this publication and to make changes from time to time in the content hereof without obligation of Elo TouchSystems to notify any person of such revisions or changes.

Trademark Acknowledgments

IntelliTouch, SecureTouch, AccuTouch, Entuitive, and MonitorMouse are trademarks of Elo TouchSystems, Inc.

Other product names mentioned herein may be trademarks or registered trademarks of their respective companies. Elo TouchSystems claims no interest in trademarks other than its own.

Table of Contents

Chapter 1		Appendix C	
Precautions	1	Compatibility Modes	33
About the Product	1	Touchmonitor Specifications ET1546L	34
Chapter 2		15" LCD Touchmonitor Dimensions	36
Unpacking Your Touchmonitor	3	ET1546L	36
Product Overview	4	Cut Out Dimensions	38
Main Unit	4	ET1546L Rear Mount Plate Cut Out	38
Rear View	4	Vertical Attachment	39
Bottom View/Side View	5	Horizontal Attachment	39
Attaching the L-Brackets	6	Without Brackets	40
Touch Interface Connection	7	Index	47
Serial Connection	7		
Connecting the Video Cable	8		
Connecting the Serial Touchscreen Cable	9		
Connect the Remote OSD Cable	10		
Connecting the Power Cable	11		
USB Connection	12		
Connecting the Video Cable	13		
Connecting the USB Touchscreen Cable	14		
Connecting the Remote OSD Cable	15		
Connecting the Power Cable	16		
Optimizing the LCD Display	17		
VESA Mount on Your Touchmonitor	17		
Installing the Driver Software	18		
Installing the Serial Touch Driver for Windows			
XP, Windows 2000, Me, 95/98 and NT 4.0	19		
Installing the Serial Touch Driver for MS-DOS			
and			
Windows 3.1	20		
Installing the USB Touch Driver	21		
Installing the USB Touch Driver for Windows			
98 and Windows 2000	21		
Chapter 3			
About Touchmonitor Adjustments	23		
Using the On-Screen Display Menus	23		
OSD Menu Function	25		
Chapter 4			
Solutions to Common Problems	27		
Appendix A			
Appendix B			
Care and Handling of Your Touchmonitor	32		

INTRODUCTION

Congratulations on your purchase of an Elo TouchSystems Entuitive LCD touchmonitor. Your new high-resolution touchmonitor combines the reliable performance of Elo's touch technology with the latest advances in LCD display design. This combination of features creates a natural flow of information between a user and your touchmonitor.

Precautions

Follow all warnings, precautions and maintenance as recommended in this user's manual to maximize the life of your unit. See Appendix B for more information on touchmonitor safety.

About the Product

Your LCD Kiosk Touchmonitor is a 15.0" XGA TFT color display with the following features:

- Direct analog RGB input
- 15.0" diagonal screen size
- 16.2 million displayable colors
- 1024 x 768 resolution
- XGA/ SVGA/ VGA/ VESA/ Mac/ NEC PC-98 compatible
- 31.5~60.2kHz horizontal scan
- 56.3~75Hz refresh rate

- Auto adjustment capability
- High quality full screen re-scaling
- Multilingual OSD menus: English, French, Dutch, Italian, Spanish, German, Swedish, Finnish, Danish and Portuguese
- VESA flat panel monitor physical mounting interface (75mm)
- For full Product Specifications refer to Appendix C.

INSTALLATION AND SETUP

Unpacking Your Touchmonitor

Check that the following 9 items are present and in good condition:

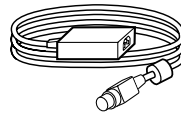
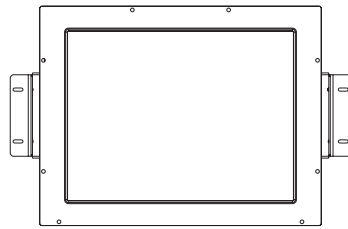

OSD remote

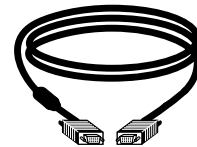

Video cable

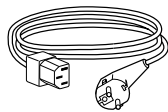

European monitor power cable

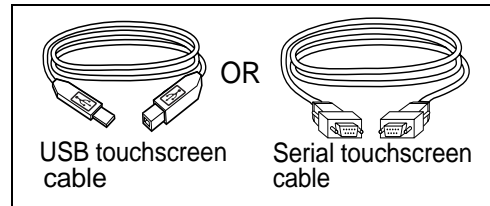

USB touchscreen cable

Serial touchscreen cable

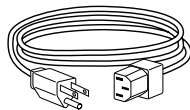

Monitor power cable (US/Canada)

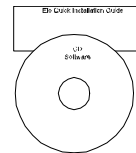

CD and Quick Install Guide



Mounting L brackets (2)

Product Overview

Main Unit

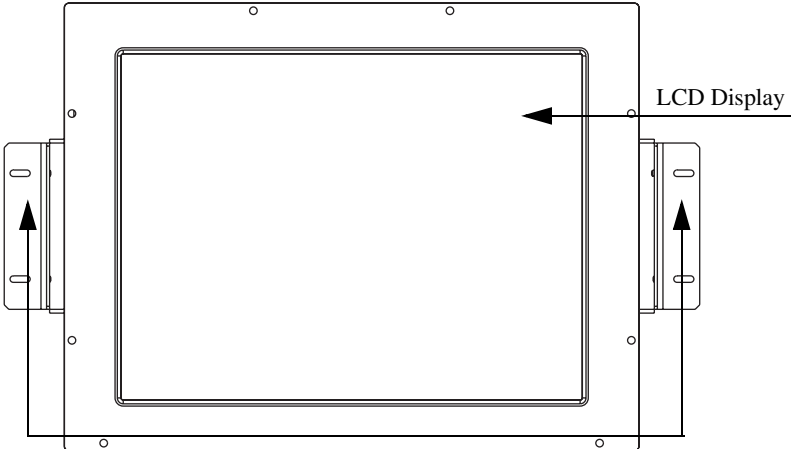

Detachable mounting L-brackets

Rear View

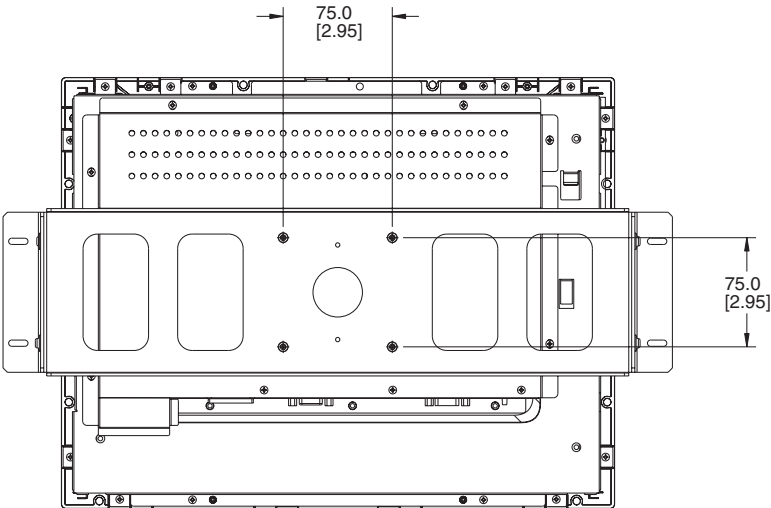

Bottom View/Side View

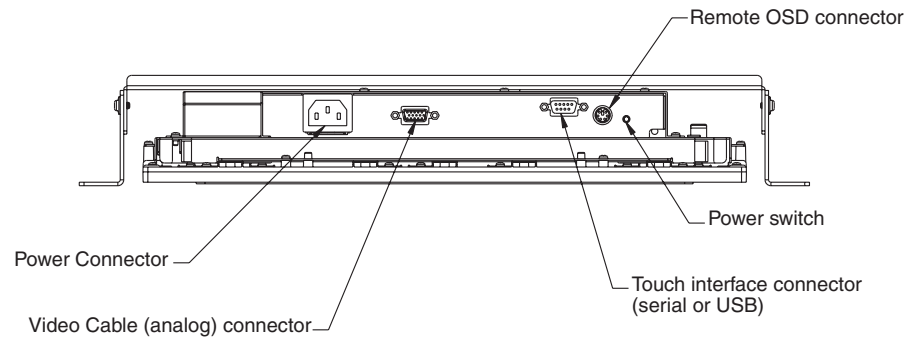

Attaching the L-Brackets

Depending on your mounting scheme, use the L-brackets or the VESA 75mm standard holes located on the back of the kiosk monitor. See page 15 for VESA mounting information.

NOTE: You will need a screwdriver to attach the L-brackets.

Your kiosk touchmonitor comes with a mounting bracket (C-bracket) attached at the back. Included are two L-brackets (and four screws) that attach to both ends of the C-bracket for additional mounting options.

To attach the L-brackets:

- 1 Lay the monitor face down.
- 2 Place the long end of the L-bracket against the end of the mounting C-bracket. Line up the two holes of the L-bracket with the two holes of the C-bracket. See the illustration below.

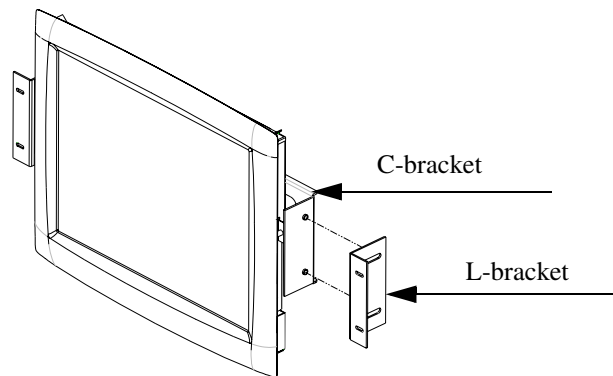

- 3 Place two screws in the holes and with the screwdriver, screw them in to secure the bracket.
- 4 Repeat steps 2 and 3 to attach the other L-bracket to the other side of the mounting bracket.

Touch Interface Connection

NOTE: Your interface cables may have been pre-connected to your monitor at the factory.

Your touchmonitor comes with one of the following touchscreen connector cables: **Serial** (RS-232) cable *or* **USB** cable (For Windows 98 or Windows 2000 computers only.)

To setup this display, please refer to the following figures and procedures:

Serial Connection

The following illustrations guide you step by step in connecting your touchmonitor using a serial cable connection.



Before connecting the cables to your touchmonitor and PC, be sure that the computer and the touchmonitor are turned off.

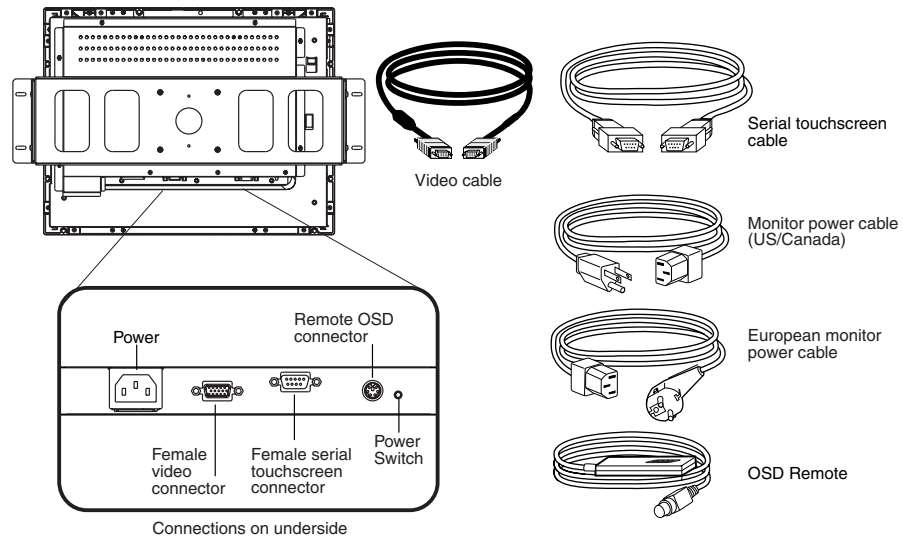

Connecting the Video Cable

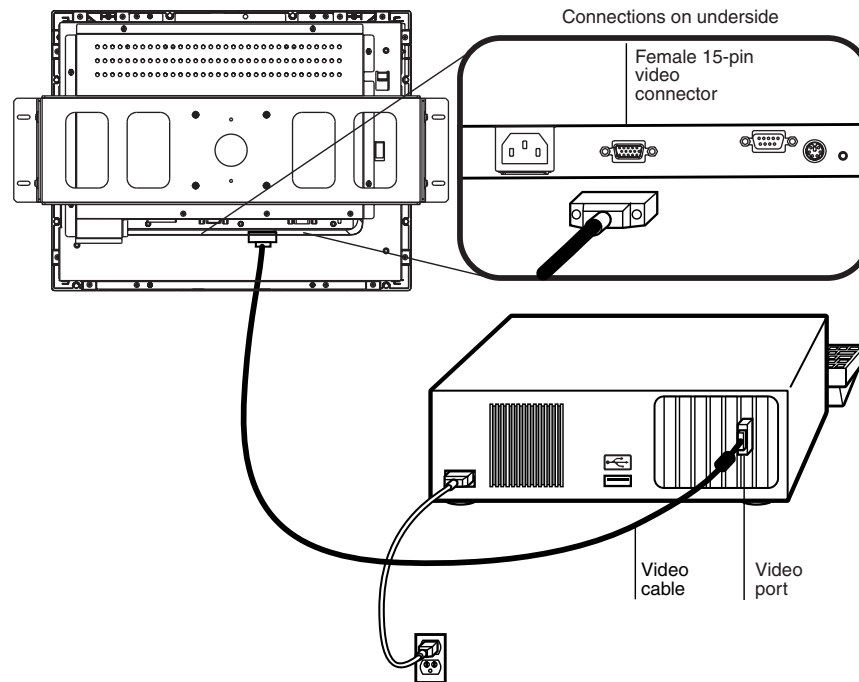

- Connect the 15-pin video cable to the video port on your PC.
- Connect the other end of the video cable to the video connector on your touchmonitor.
- Secure the cable to your touchmonitor and PC by turning the screws on the connector clockwise.

Connecting the Serial Touchscreen Cable

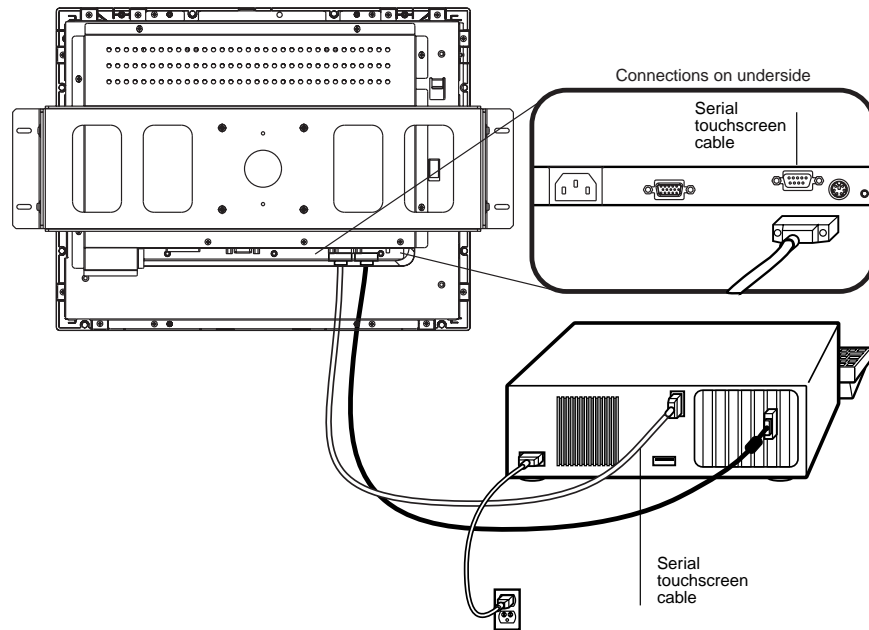

- Connect the female end of the serial (RS-232) cable to the serial port on the back of your PC.
- Connect the male end of the cable to the serial touchscreen connector on your touchmonitor.
- Secure the cable to your touchmonitor and PC by turning the screws on the connector.

Connect the Remote OSD Cable

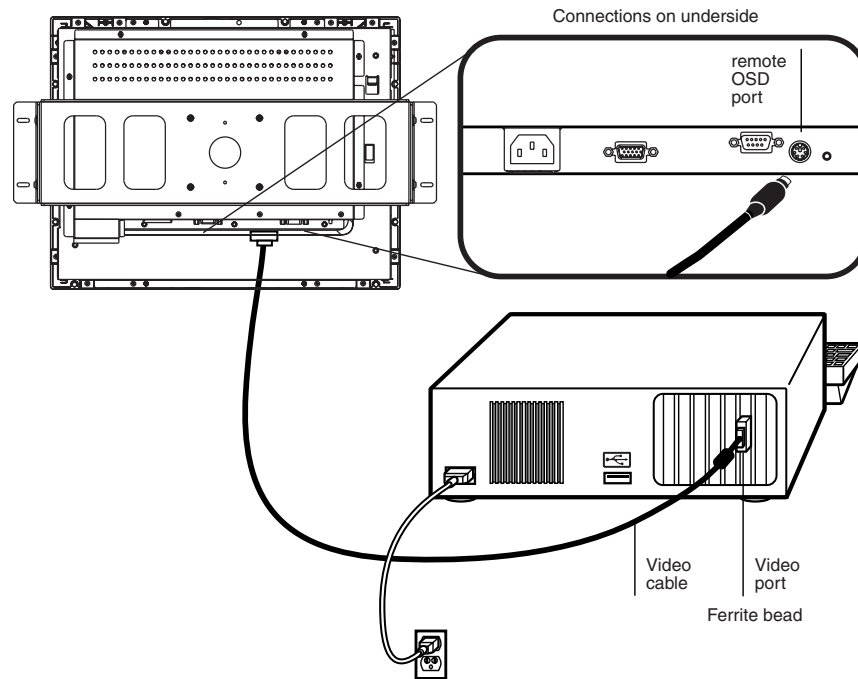

- Connect the 6 pin DIN cable to the OSD Remote port on your touchmonitor.

Connecting the Power Cable

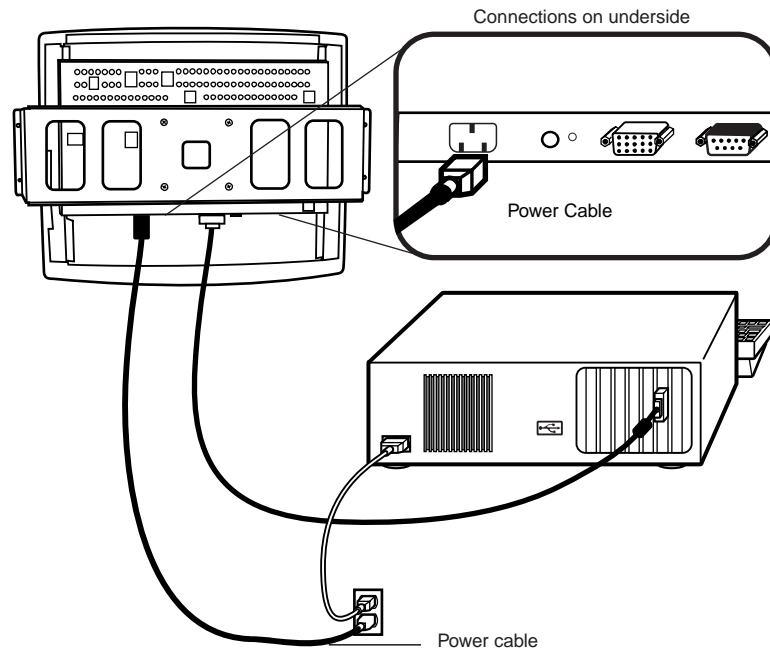

Depending on where you live, you will use either the European or US/Canadian power cable.

- Connect the female end of the power cable into the power port on the touchmonitor.

NOTE: To protect your equipment against risk of damage from electrical surges in the power line, plug the touchmonitor's power cord into a surge protector, and then connect the surge protector to a grounded (three-pronged) AC electrical outlet.

- Power on your PC then your touchmonitor. After a brief pause the picture should appear.

USB Connection

NOTE: A USB connection can only be used if your PC is running Windows 98 or Windows 2000.

The following illustrations guide you step by step in connecting your touchmonitor using a USB cable connection.



Before connecting the cables to your touchmonitor and PC, be sure that the computer and the touchmonitor are turned off.

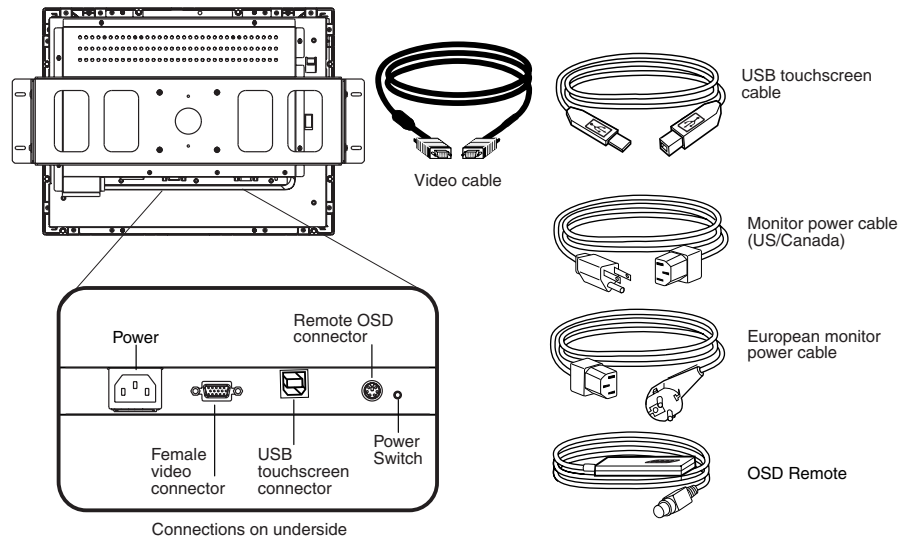

Connecting the Video Cable

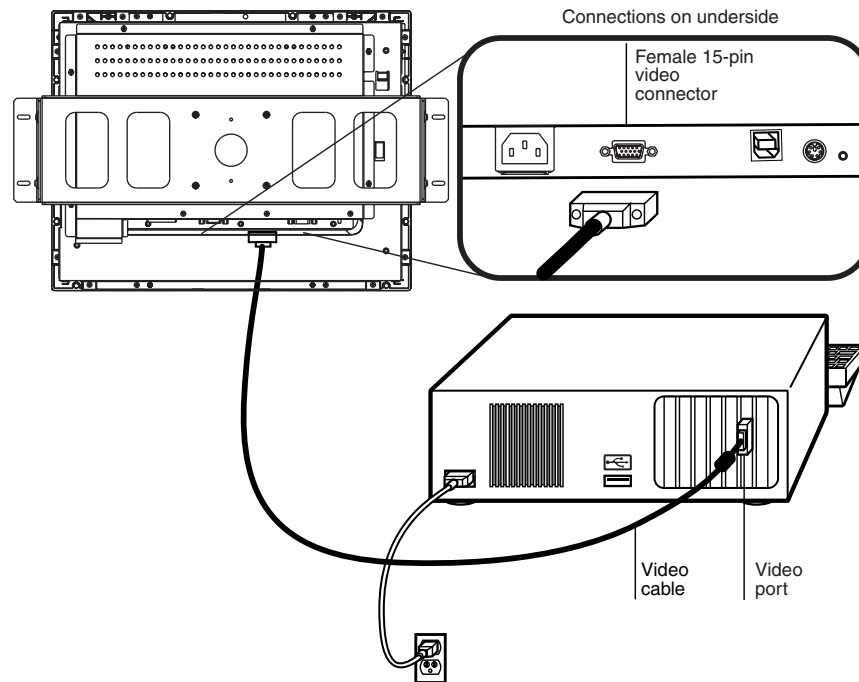

- Connect the 15-pin video cable to the video port on your PC.
- Connect the other end of the video cable to the video connector on your touchmonitor.
- Secure the cable to your touchmonitor and PC by turning the screws on the connector clockwise.

Connecting the USB Touchscreen Cable

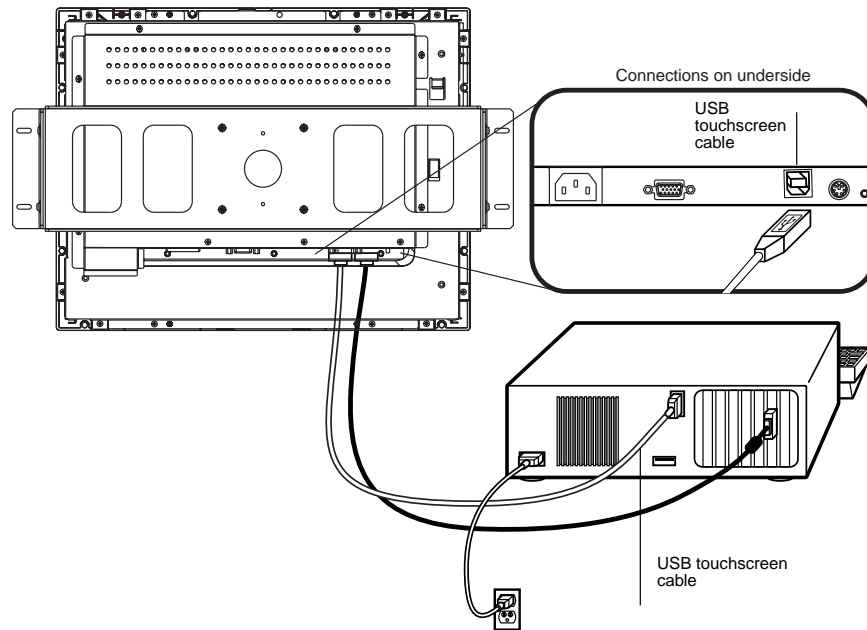

- Connect the USB touchscreen cable to the USB touchscreen connector on the touchmonitor.
- Connect the other end of the USB cable to your PC.
- The touchscreen cable connectors should fit snugly into the connectors on your touchmonitor and PC.

Connecting the Remote OSD Cable

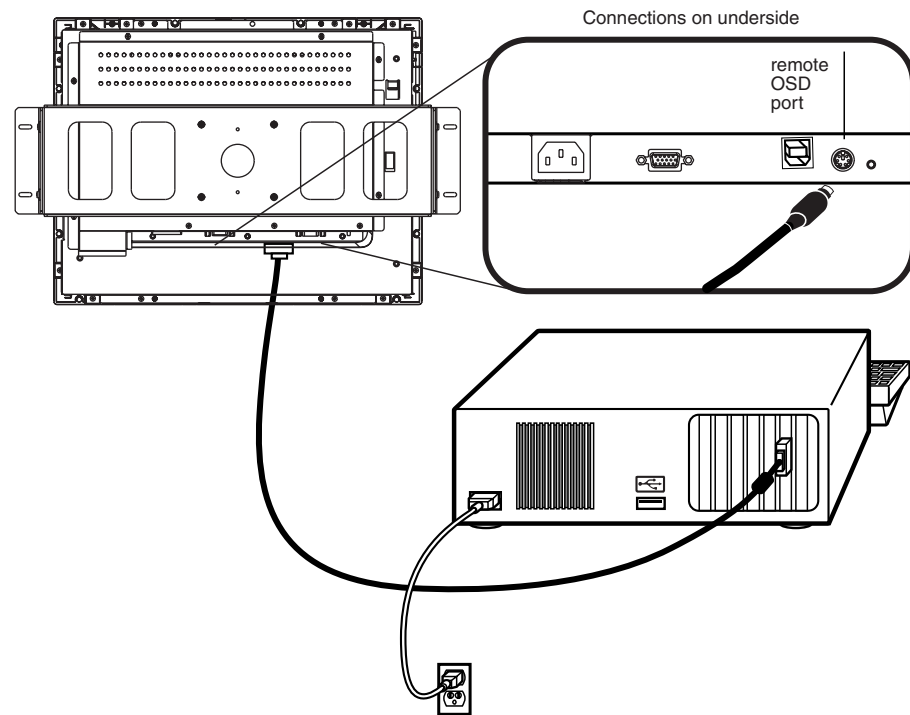

- Connect the 6 pin DIN cable to the OSD Remote port on your touchmonitor.

Connecting the Power Cable

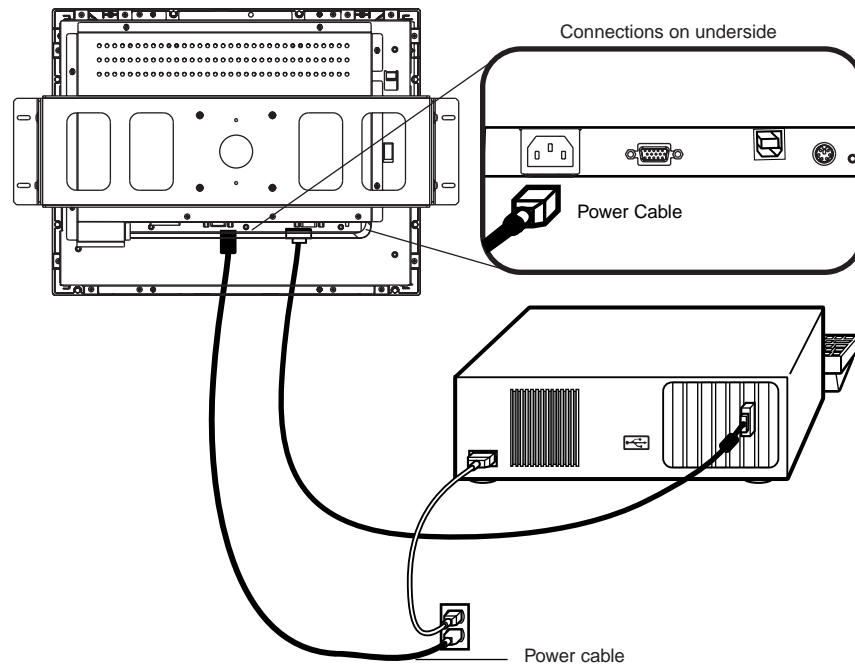

Depending on where you live, you will use either the European or US/Canadian power cable.

- Connect the female end of the power cable into the power port on the touchmonitor.

NOTE: To protect your equipment against risk of damage from electrical surges in the power line, plug the touchmonitor's power cord into a surge protector, and then connect the surge protector to a grounded (three-pronged) AC electrical outlet.

- Power on your PC then your touchmonitor. After a brief pause the picture should appear.

Optimizing the LCD Display

To ensure the LCD display works well with your computer, configure the display mode of your graphic card to make it less than or equal to 1024 x 768 resolution, and make sure the timing of the display mode is compatible with the LCD display. Refer to Appendix A for more information about resolution. Compatible video modes for your touchmonitor are listed in Appendix C.

VESA Mount on Your Touchmonitor

Your kiosk touchmonitor comes with a VESA standard mounting bracket (C bracket) attached at the back. Included are two sliders (L brackets) that attach to both ends of the C bracket for additional mounting options. Your touchmonitor conforms to the VESA Flat Panel Monitor Physical Mounting Interface (FPMPMI™) Standard which defines a physical mounting interface for flat panel monitors, and corresponding standards for flat panel monitor mounting devices, such as wall and table arms.

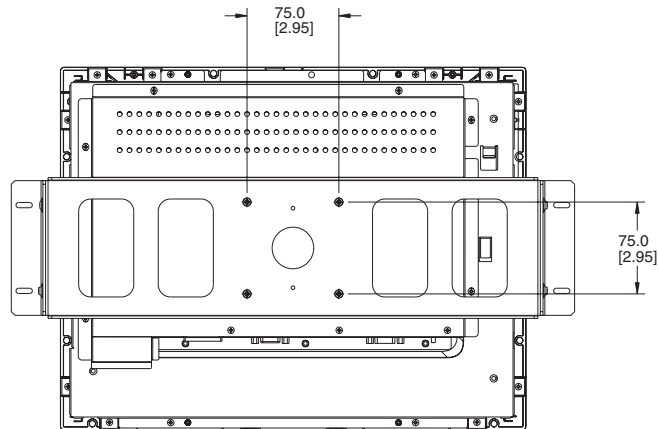

The following companies provide VESA mounting devices compatible with your touchmonitor:

Ergotron
800-888-8458
651-681-7600
www.ergotron.com

GCX
800-228-2555
707-773-1100
www.gcx.com

Innovative Office Products
800-524-2744
610-253-9554
www.innov-office-prod.com

MRI
800-688-2414
www.mediarecovery.com

Installing the Driver Software

Elo TouchSystems provides driver software that allows your touchmonitor to work with your computer. Drivers are located on the enclosed CD-ROM for the following operating systems:

- Windows XP
- Windows 2000
- Windows Me
- Windows 98
- Windows 95
- Windows NT 4.0

Additional drivers and driver information for other operating systems (including MS DOS, Windows 3.x, OS/2, Macintosh and Linux) are available on the Elo TouchSystems web site at www.elotouch.com.

Your Elo touchmonitor is plug-and-play compliant. Information on the video capabilities of your touchmonitor is sent to your video display adapter when Windows starts. If Windows detects your touchmonitor, follow the instructions on the screen to install a generic plug-and-play monitor.

Refer to the appropriate following section for driver installation instructions.

Installing the Serial Touch Driver for Windows XP, Windows 2000¹, Me, 95/98 and NT 4.0

NOTE: For Windows 2000 and NT 4.0 you must have administrator access rights to install the driver.

1 Insert the Elo CD-ROM in your computer's CD-ROM drive.

If the AutoStart feature for your CD-ROM drive is active, the system automatically detects the CD and starts the setup program.

2 Follow the directions on the screen to complete the driver setup for your version of Windows.

If the AutoStart feature is not active:

1 Click **Start > Run**.

2 Click the **Browse** button to locate the EloCd.exe program on the CD-ROM.

3 Click **Open**, then **OK** to run EloCd.exe.

4 Follow the directions on the screen to complete the driver setup for your version of Windows.

¹To install Windows 2000 and Windows XP, you must use the "update driver" method; you will not find a setup.exe file within the download.

Installing the Serial Touch Driver for MS-DOS and Windows 3.1

To install Windows 3.x and MS-DOS from Windows 95/98, follow the directions below:

- 1 Insert the Elo CD-ROM in your computer's CD-ROM drive.
- 2 From DOS, type `d:\EloDos_W31` to change to the correct directory on the CD-ROM (your CD-ROM drive may be mapped to a different drive letter).
- 3 Type `install` and press **Enter** to start the installation.
- 4 Align the touchscreen.

You must have already completed Steps 1 and 2 before proceeding. Refer to Chapter 2 of the Elo DOS and Windows Driver Guide as necessary for additional installation information.

To run the INSTALL program:

- 1 Type `INSTALL` at the DOS prompt in the directory containing the driver install files.
- 2 `INSTALL` asks you to select the software to install. Then choose `d:\EloDos_W31` from the displayed list.
- 3 `INSTALL` also asks you for the paths to use during installation, or you may use its defaults. `INSTALL` creates directories as necessary, and warns you if they exist.

If you are updating your software, you may wish to specify the paths containing the earlier versions, and overwrite the obsolete files. All executable programs are upward compatible. For a list of differences from each previous version of the drivers, be sure to select "Differences from Previous Versions" during the installation process.

`INSTALL` updates your `AUTOEXEC.BAT` file with the drivers you select. `INSTALL` makes a copy of your original `AUTOEXEC.BAT` file, called `AUTOEXEC.OLD`. If you already have Elo driver commands in your `AUTOEXEC.BAT` file, they will be commented out.

When `INSTALL` is finished, it leaves a file called `GO.BAT` in the subdirectory you specified. `GO` loads the touchscreen driver, runs the calibration program `ELOCALIB`, and gives you some final instructions.

If you are using Windows 3.1, you will also align the touchscreen within Windows 3.1 with the Touchscreen Control Panel.

Installing the USB Touch Driver

Installing the USB Touch Driver for Windows 98 and Windows 2000

- 1 Insert the Elo CD-ROM in your computer's CD-ROM drive.
If Windows 98 or Windows 2000 starts the Add New Hardware Wizard:
 - 2 Choose **Next**. Select "Search for the best driver for your device (Recommended)" and choose **Next**.
 - 3 When a list of search locations is displayed, place a checkmark on "Specify a location" and use **Browse** to select the \EloUSB directory on the Elo CD-ROM.
 - 4 Choose **Next**. Once the Elo TouchSystems USB touchscreen driver has been detected, choose **Next** again.
 - 5 You will see several files being copied. Insert your Windows 98 CD if prompted. Choose **Finish**.

If Windows 98 or Windows 2000 does not start the Add New Hardware Wizard:

NOTE: For Windows 2000 you must have administrator access rights to install the driver.

- 1 Insert the Elo CD-ROM in your computer's CD-ROM drive.
If the AutoStart feature for your CD-ROM drive is active, the system automatically detects the CD and starts the setup program.
- 2 Follow the directions on the screen to complete the driver setup for your version of Windows.

If the AutoStart feature is not active:

- 1 Click **Start > Run**.
- 2 Click the **Browse** button to locate the EloCd.exe program on the CD-ROM.
- 3 Click **Open**, then **OK** to run EloCd.exe.
- 4 Follow the directions on the screen to complete the driver setup for your version of Windows.

About Touchmonitor Adjustments

Your touchmonitor will likely require adjustment. Variations in video output and application will require you to adjust your touchmonitor to optimize the quality of the display.

For best performance, your monitor should be operating in native resolution, that is 1024 x 768 at 60-75 Hz. Use the Display control panel in Windows to choose 1024 x 768 resolution.

Operating in other resolutions will degrade video performance. For further information, please refer to Appendix A.

All adjustments you make to the controls are automatically memorized. This feature saves you from having to reset your choices every time you unplug or power your touchmonitor off and on. If there is a power failure your touchmonitor settings will not default to the factory specifications.

Using the On-Screen Display Menus

All adjustments are made by using the on-screen display (OSD) menus. All menu items can be selected by using the buttons on the side bezel.

NOTE: OSD menu default is enabled. Press the UP and DOWN buttons at the same time to enable/disable the OSD functions

Remote OSD Buttons

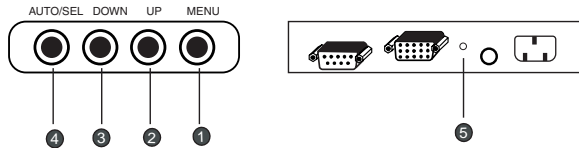
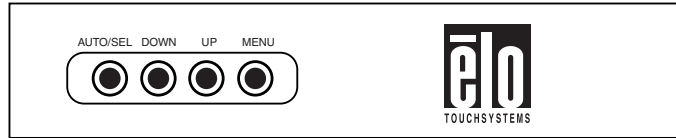



	Control	Function
① MENU	Menu	Display Exits the OSD menus.
② UP	Contrast/ Plus/Clockwise	1. Enter contrast of the OSD 2. Increase value of the adjustment item. 3. Select item clockwise
③ DOWN	Brightness/Minus/ Counter-Clockwise	1. Enter brightness of the OSD 2. Decrease value of the adjustment item 3. Select item counter-clockwise
④ AUTO/SEL	Auto/Select	Select- To select the adjustment items from the OSD menus. Auto- To activate the "Auto Adjustment" function to obtain an optimum image.
⑤	Power Switch	Switches on/off the power of your touchmonitor.
	Enable/Disable	1. Press the Menu and Up buttons at the same time and hold for two seconds to enable/disable the OSD functions. OSD menu default is enabled. 2. Press the Menu and Down buttons at the same time to enable/disable the power lock function.

OSD Menu Function





 **Brightness**
Controls the picture brightness

 **Contrast**
Controls the picture contrast

 **Color Control**
You can select one of the default color temperatures (5500°K, 6500°K and 9300°K). Press the OSD button Up or Down, or set color values individually using the User option.,

 **Position**
Controls the horizontal and vertical position.

 **Phase/Clock**
Controls the horizontal image size
Controls vertical and horizontal fine tuning

 **Auto Adjust**
Automatically selects the optional settings for image parameters (brightness, contrast, image position, phase, etc.)

 **Recall**
Recalls factory setting of the image parameters

 **OSD Language**
Selection of OSD menu languages: English, French, Dutch, Italian, Spanish, German, Swedish, Finnish, Danish and Portuguese.

TROUBLESHOOTING

If you are experiencing trouble with your touchmonitor, refer to the following table. If the problem persists, please contact your local dealer or our service center.

Solutions to Common Problems

Problem	Suggestion(s)
No image appears on screen.	<p>Check that all the I/O and power connectors are properly connected as described in Chapter 2.</p> <p>Make sure the pins of the connectors are not crooked or broken.</p> <p>Test power supply by trying different cables, a different wall outlet or plug another appliance into the outlet.</p> <p>Make certain the video cable is properly connected and that it is not damaged. Check for bent pins on the cable connectors.</p> <p>Ensure that your computer and video card are properly configured. (Consult video card documentation.)</p>
“Out of Range” display	<p>Check to see if the resolution of your computer is higher than that of the LCD display.</p> <p>Reconfigure the resolution of your computer to make it less than or equal to 1024 x 768. See Appendix A for more information on resolution.</p>

Image has vertical flickering line bars.	Use "PHASE" to make an adjustment. Check and reconfigure the display mode of the vertical refresh rate of your graphic card to make it compatible with the LCD display.
Image is unstable and flickering	Use "CLOCK" to make an adjustment.
Image is scrolling	Make sure the VGA signal cable (or adapter) is well connected. Check and reconfigure the display mode of the vertical refresh rate of your graphic card to make it compatible with the LCD display.
Touch doesn't work	Make sure cable is securely attached at both ends.



NATIVE RESOLUTION

The native resolution of a monitor is the resolution level at which the LCD panel is designed to perform best. For the Elo LCD touchmonitor, the native resolution is 1024 x 768 for the XGA-15 inch size. In almost all cases, screen images look best when viewed at their native resolution. You can lower the resolution setting of a monitor but not increase it.

Input Video	15" LCD
640x480 (VGA)	Transforms input format to 1024x768
800x600 (SVGA)	Transforms input format to 1024x768
1024x768 (XGA)	Displays in Native Resolution

The native resolution of an LCD is the actual number of pixels horizontally in the LCD by the number of pixels vertically in the LCD. LCD resolution is usually represented by the following symbols:

VGA	640x480
SVGA	800x600
XGA	1024x768
SXGA	1280x1024
UXGA	1600x1200

As an example, a SVGA resolution LCD panel has 800 pixels horizontally by 600 pixels vertically. Input video is also represented by the same terms. XGA input video has a format of 1024 pixels horizontally by 768 pixels vertically. When the input pixels contained in the video input format match the native resolution of the panel, there is a one to one correspondence of mapping of input video pixels to LCD pixels. As an example, the pixel in 45 column and 26 row of the input video is in 45 column and 26 row of the LCD. For the case when the input video is at a lower resolution than the native resolution of the LCD, the direct correspondence between the video pixels and the LCD pixels is lost. The LCD controller can compute the correspondence between video pixels and LCD pixels using algorithms contained in the controller. The accuracy of the algorithms determines the fidelity of conversion of video pixels to LCD pixels. Poor fidelity conversion can result in artifacts in the LCD displayed image such as varying width characters.

B

TOUCHMONITOR SAFETY

This manual contains information that is important for the proper setup and maintenance of your touchmonitor. Before setting up and powering on your new touchmonitor, read through this manual, especially Chapter 2 (Installation), and Chapter 3 (Operation).

- 1** To reduce the risk of electric shock, follow all safety notices and never open the touchmonitor case.
- 2** Turn off the product before cleaning
- 3** Your new touchmonitor is equipped with a 3-wire, grounding power cord. The power cord plug will only fit into a grounded outlet. Do not attempt to fit the plug into an outlet that has not been configured for this purpose. Do not use a damaged power cord. Use only the power cord that comes with your Elo TouchSystems Touchmonitor. Use of an unauthorized power cord may invalidate your warranty.
- 4** The slots located on the sides and top of the touchmonitor case are for ventilation. Do not block or insert anything inside the ventilation slots.
- 5** It is important that your touchmonitor remains dry. Do not pour liquid into or onto your touchmonitor. If your touchmonitor becomes wet do not attempt to repair it yourself.

Care and Handling of Your Touchmonitor

The following tips will help keep your Elo Entuitive touchmonitor functioning at the optimal level.

- To avoid risk of electric shock, do not disassemble the brick supply or display unit cabinet. The unit is not user serviceable. Remember to unplug the display unit from the power outlet before cleaning.
- Do not use alcohol (methyl, ethyl or isopropyl) or any strong dissolvent. Do not use thinner or benzene, abrasive cleaners or compressed air.
- To clean the display unit cabinet, use a cloth lightly dampened with a mild detergent.
- Avoid getting liquids inside your touchmonitor. If liquid does get inside, have a qualified service technician check it before you power it on again.
- Do not wipe the screen with a cloth or sponge that could scratch the surface.
- To clean the touchscreen, use window or glass cleaner. Put the cleaner on the rag and wipe the touchscreen. *Never* apply the cleaner directly on the touchscreen.



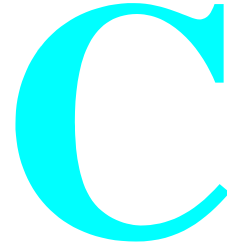

TECHNICAL SPECIFICATIONS

Compatibility Modes

Your Elo Entuitive touchmonitor is compatible with the following video modes:

Mode	Resolution	H. Frequency (kHz)	V. Frequency (Hz)
IBM & VESA VGA	720 x 400	31.47	70.09
IBM & VESA VGA	640 x 480	31.47	59.94
IBM & VESA VGA	640 x 480	37.86	72.81
IBM & VESA XGA	1024 x 768	56.5	70.10
IBM & VESA XGA	1024 x 768	48.4	60.00
IBM & VESA XGA	1024 x 768	60.24	75.02
VESA VGA	800 x 600	37.88	60.32
VESA VGA	800 x 600	46.88	75.00

Touchmonitor Specifications ET1546L

Table C.1 15" LCD Touchmonitor Specifications

Display Type	Active matrix, thin film transistor (TFT), liquid crystal display	
Size	15-inch diagonal 304 x 228 mm useful screen area	
Pixel Format	1024 x 768	
Touchscreen	0.125-inch IntelliTouch anti-glare Surface wave technology	
Colors	16.2 million	
Display Brightness	IntelliTouch: 225 cd/m ² Max.	
Back-light Lamp Life	40,000 hours at full brightness typical	
Viewing Angle	Horizontal	-70~70 or 140 degrees total
	Vertical	-60~55 or 150 degrees total
Contrast Ratio	300:1 typical	
Display Response Time	13 ms(tr)/27 ms(tr)	
Environmental	Operating Temp	0°C to 35°C
	Storage Temp	-20°C to +60°C
	Humidity	80% non-condensing
	Weight	10.6 lbs. maximum approx. weight for IntelliTouch See drawings on pages 34, and 36.
Mechanical	Size	
Electrical	Input Video	VGA/SVGA/XGA analog video
	Input Power	100-240 VAC, 50/60 Hz.
	Power Dissipation	Universal
Agencies	Safety & EMC	UL, cUL and TUV
		FCC-B, CE, C-Tick, MRPII and VCCI

Table C.2 IntelliTouch Touchmonitor Specifications

Mechanical	
Positional Accuracy	Standard deviation of error is less than 0.080 in. (2.03 mm). Equates to less than $\pm 1\%$.
Touchpoint Density	More than 100,000 touchpoints/in ² (15,500 touchpoints/cm ²).
Touch Activation Force	Typically less than 3 ounces (85 grams).
Surface Durability	Surface durability is that of glass, Mohs' hardness rating of 7.
Expected Life Performance	No known wear-out mechanism, as there are no layers, coatings, or moving parts. IntelliTouch technology has been operationally tested to more than 50 million touches in one location without failure, using a stylus similar to a finger.
Sealing	Unit is sealed to protect against splashed liquids, dirt, and dust. See IntelliTouch Ultra Product Manual for details.
Optical	
Light Transmission (per ASTM D1003)	92%
Visual Resolution	All measurements made using USAF 1951 Resolution Chart, under 30X magnification, with test unit located approximately 1.5 in (38 mm) from surface of resolution chart. Clear surface: Excellent, with no noticeable degradation. Antiglare surface: 6:1 minimum.
Gloss (per ASTM D2457 using a 60-degree gloss meter)	Clear surface: N/A Antiglare surface: Curved: 60 ± 20 gloss units or 75 ± 15 gloss units.
Environmental	
Chemical Resistance	The active area of the touchscreen is resistant to all chemicals that do not affect glass, such as: Acetone Toluene Methyl ethyl ketone Isopropyl alcohol Methyl alcohol Ethyl acetate Ammonia-based glass cleaners Gasoline Kerosene Vinegar
Electrostatic Protection (per EN 61 000-4-2, 1995)	Meets Level 4 (15 kV air/8 kV contact discharges).

15" LCD Touchmonitor Dimensions

ET1546L

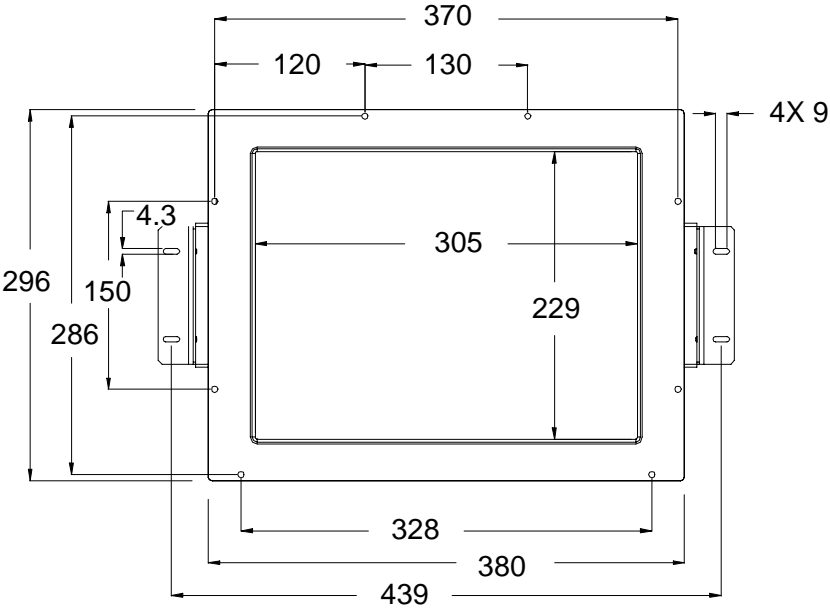

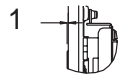

Detail A
Scale 1:1

See Detail A

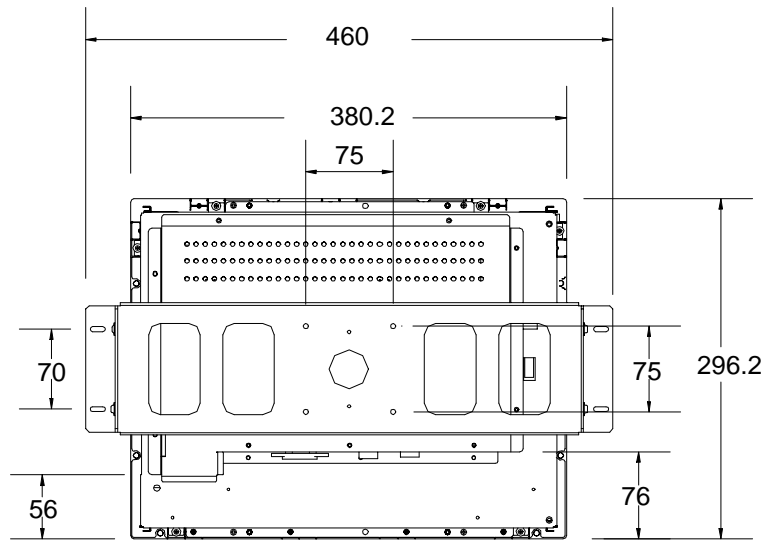
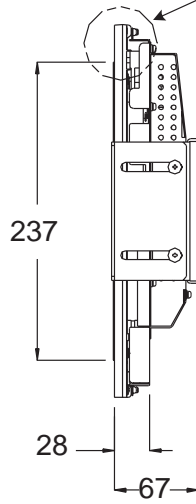

See www.elotouch.com/pdfs/drawings/ms500235.pdf

Cut Out Dimensions

ET1546L Rear Mount Plate Cut Out

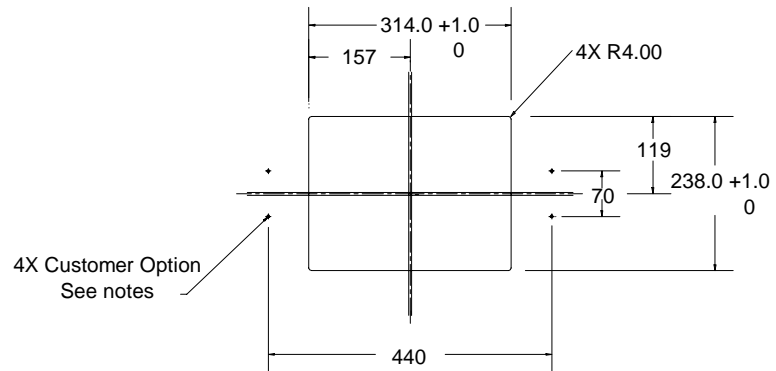

NOTES:

Material:

1. Wood: $\text{Ø}4.5$ holes thru for M4 screws w/nuts or screws for wood $\text{Ø}4$ mm.
2. Sheet Metal: Concealed head threaded studs M4 w/nuts.

Vertical Attachment

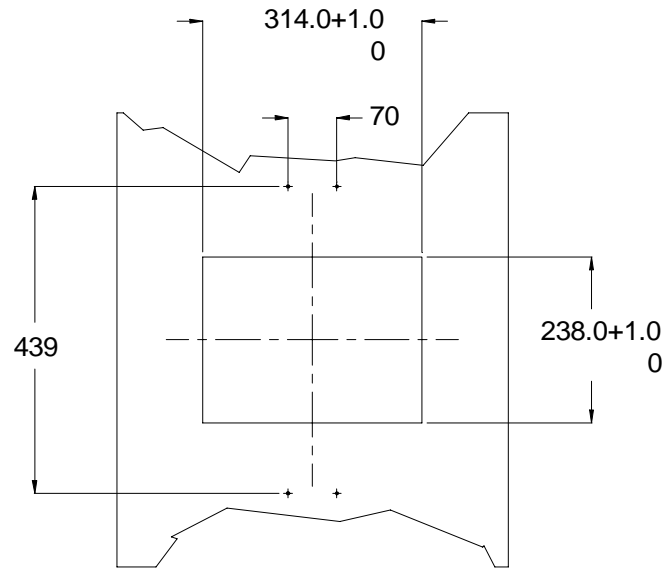

Vertical Attachment

Horizontal Attachment

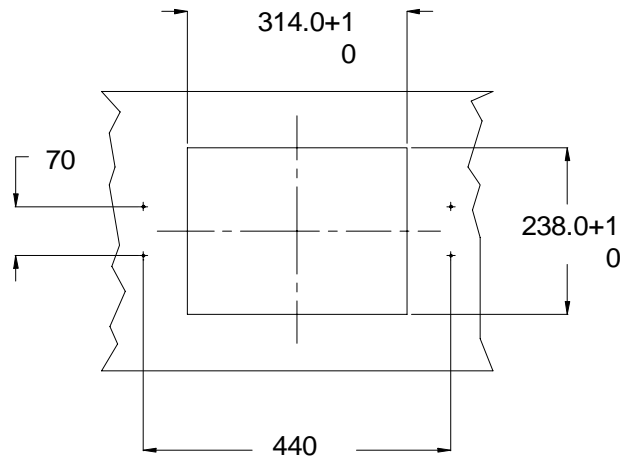

Horizontal Attachment

Without Brackets

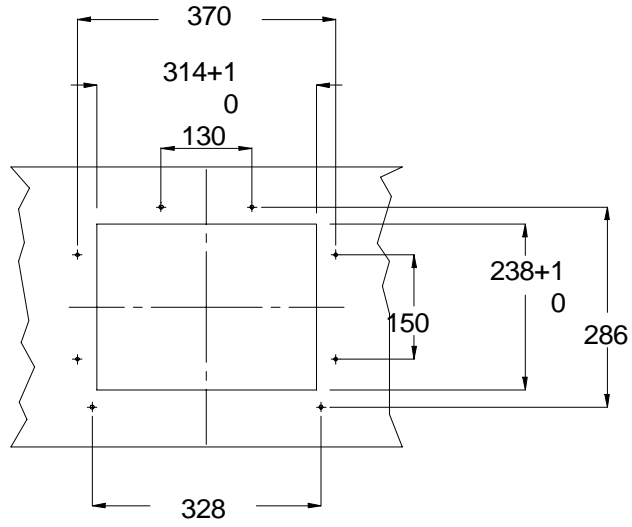

Without Brackets

WARRANTY

Except as otherwise stated herein or in an order acknowledgment delivered to Buyer, Seller warrants to Buyer that the Product shall be free of defects in materials and workmanship. The warranty for the touchmonitors and components of the product is 1 year.

Seller makes no warranty regarding the model life of components. Seller's suppliers may at any time and from time to time make changes in the components delivered as Products or components.

Buyer shall notify Seller in writing promptly (and in no case later than thirty (30) days after discovery) of the failure of any Product to conform to the warranty set forth above; shall describe in commercially reasonable detail in such notice the symptoms associated with such failure; and shall provide to Seller the opportunity to inspect such Products as installed, if possible. The notice must be received by Seller during the Warranty Period for such product, unless otherwise directed in writing by the Seller. Within thirty (30) days after submitting such notice, Buyer shall package the allegedly defective Product in its original shipping carton(s) or a functional equivalent and shall ship to Seller at Buyer's expense and risk.

Within a reasonable time after receipt of the allegedly defective Product and verification by Seller that the Product fails to meet the warranty set forth above, Seller shall correct such failure by, at Seller's options, either (i) modifying or repairing the Product or (ii) replacing the Product. Such modification, repair, or replacement and the return shipment of the Product with minimum insurance to Buyer shall be at Seller's expense. Buyer shall bear the risk of loss or damage in transit, and may insure the Product. Buyer shall reimburse Seller for transportation cost incurred for Product returned but not found by Seller to be defective. Modification or repair, of Products may, at Seller's option, take place either at Seller's facilities or at Buyer's premises. If Seller is unable to modify, repair, or replace a Product to conform to the warranty set forth above, then Seller shall, at Seller's option, either refund to Buyer or credit to Buyer's account the purchase price of the Product less depreciation calculated on a straight-line basis over Seller's stated Warranty Period.

THESE REMEDIES SHALL BE THE BUYER'S EXCLUSIVE REMEDIES FOR BREACH OF WARRANTY. EXCEPT FOR THE EXPRESS WARRANTY SET FORTH ABOVE, SELLER GRANTS NO OTHER WARRANTIES, EXPRESS OR IMPLIED BY STATUTE OR OTHERWISE, REGARDING THE PRODUCTS, THEIR FITNESS FOR ANY PURPOSE, THEIR QUALITY, THEIR MERCHANTABILITY, THEIR NONINFRINGEMENT, OR OTHERWISE. NO EMPLOYEE OF SELLER OR ANY OTHER PARTY IS AUTHORIZED TO MAKE ANY WARRANTY FOR THE GOODS OTHER THAN THE WARRANTY SET FORTH HEREIN. SELLER'S LIABILITY UNDER THE WARRANTY SHALL BE LIMITED TO A REFUND OF THE PURCHASE PRICE OF THE PRODUCT. IN NO EVENT SHALL SELLER BE LIABLE FOR THE COST OF PROCUREMENT OR INSTALLATION OF SUBSTITUTE GOODS BY BUYER OR FOR ANY SPECIAL, CONSEQUENTIAL, INDIRECT, OR INCIDENTAL DAMAGES.

Buyer assumes the risk and agrees to indemnify Seller against and hold Seller harmless from all liability relating to (i) assessing the suitability for Buyer's intended use of the Products and of any system design or drawing and (ii) determining the compliance of Buyer's use of the Products with applicable laws, regulations, codes, and standards. Buyer retains and accepts full responsibility for all warranty and other claims relating to or arising from Buyer's products, which include or incorporate Products or components manufactured or supplied by Seller. Buyer is solely responsible for any and all representations and warranties regarding the Products made or authorized by Buyer. Buyer will indemnify Seller and hold Seller harmless from any liability, claims, loss, cost, or expenses (including reasonable attorney's fees) attributable to Buyer's products or representations or warranties concerning same.

REGULATORY INFORMATION

I. Electrical Safety Information:

A) Compliance is required with respect to the voltage, frequency, and current requirements indicated on the manufacturer's label. Connection to a different power source than those specified herein will likely result in improper operation, damage to the equipment or pose a fire hazard if the limitations are not followed.

B) There are no operator serviceable parts inside this equipment. There are hazardous voltages generated by this equipment which constitute a safety hazard. Service should be provided only by a qualified service technician.

C) This equipment is provided with a detachable power cord which has an integral safety ground wire and 3-prong connector intended for connection to a grounded safety outlet.

1) Do not substitute the cord with other than the provided approved type. Under no circumstances use an adapter plug to connect to a 2-wire outlet as this will defeat the continuity of the grounding wire.

2) The equipment requires the use of the ground wire as a part of the safety certification, modification or misuse can provide a shock hazard that can result in serious injury or death.

3) Contact a qualified electrician or the manufacturer if there are questions about the installation prior to connecting the equipment to mains power.

II. Emissions and Immunity Information

A) Notice to Users in the United States: This equipment has been tested and found to comply with the limits for a Class B digital device, pursuant to Part 15 of FCC Rules. These limits are designed to provide reasonable protection against harmful interference in a residential installation. This equipment generates, uses, and can radiate radio frequency energy, and if not installed and used in accordance with the instructions, may cause harmful interference to radio communications.

B) Notice to Users in Canada: This equipment complies with the Class B limits for radio noise emissions from digital apparatus as established by the Radio Interference Regulations of Industrie Canada.

C) Notice to Users in the European Union: Use only the provided power cords and interconnecting cabling provided with the equipment. Substitution of provided cords and cabling may compromise electrical safety or CE Mark Certification for emissions or immunity as required by the following standards:

This Information Technology Equipment (ITE) is required to have a CE Mark on the manufacturer's label which means that the equipment has been tested to the following Directives and Standards:

This equipment has been tested to the requirements for the CE Mark as required by EMC Directive 89/336/EEC indicated in European Standard EN 55 022 Class B and the Low Voltage Directive 73/23/EEC as indicated in European Standard EN 60 950.

D) General Information to all Users: This equipment generates, uses and can radiate radio frequency energy. If not installed and used according to this manual the equipment may cause interference with radio and television communications. There is, however, no guarantee that interference will not occur in any particular installation due to site-specific factors.

1) In order to meet emission and immunity requirements, the user must observe the following:

- a) Use only the provided I/O cables to connect this digital device with any computer.
- b) To ensure compliance, use only the provided manufacturer's approved line cord.
- c) The user is cautioned that changes or modifications to the equipment not expressly approved by the party responsible for compliance could void the user's authority to operate the equipment.

2) If this equipment appears to cause interference with radio or television reception, or any other device:

- a) Verify as an emission source by turning the equipment off and on.
- b) If you determine that this equipment is causing the interference, try to correct the interference by using one or more of the following measures:
 - i) Move the digital device away from the affected receiver.
 - ii) Reposition (turn) the digital device with respect to the affected receiver.
 - iii) Reorient the affected receiver's antenna.
 - iv) Plug the digital device into a different AC outlet so the digital device and the receiver are on different branch circuits.
 - v) Disconnect and remove any I/O cables that the digital device does not use. (Unterminated I/O cables are a potential source of high RF emission levels.)
 - vi) Plug the digital device into only a grounded outlet receptacle. Do not use AC adapter plugs. (Removing or cutting the line cord ground may increase RF emission levels and may also present a lethal shock hazard to the user.)

If you need additional help, consult your dealer, manufacturer, or an experienced radio or television technician.

"The application of this monitor is restricted to special controlled luminous environments. The screen surface tends to reflect annoying light of lamps and sunlight. To avoid these reflections the monitor should not be positioned in front of a window or directed to luminaries. The monitor is in compliance with Reflection Class III according to ISO 9241-7"

“Die Anwendung dieses Bildschirms ist auf speziell kontrollierte Umgebungsbeleuchtungen eingeschränkt. Die Bildschirmoberfläche neigt zu störenden Spiegelungen von Lampen und Sonnenlicht. Um diese Reflexionen zu vermeiden sollte der Monitor nicht auf Fenster und Beleuchtungseinrichtungen ausgerichtet sein. Der Monitor erfüllt nur die Reflexionsklasse III nach ISO9241-7"



Index

Numerics

- 15" LCD Touchmonitor Dimensions 36
- 15" LCD Touchmonitor (ET15-XXWC-1) Specifications 34

A

- About the Product 1
- About Touchmonitor Adjustments 23
- Attaching the L-Brackets 6
- Auto Adjust 25

B

- Bottom View/Side View (1545L) 5
- Brightness 25

C

- Care and Handling of Your Touchmonitor 32
- Color Control 25
- Compatibility Modes 33
- Connect the Remote OSD Cable 10
- Connecting the Power Cable 11, 16
- Connecting the Remote OSD Cable 15
- Connecting the Serial Touchscreen Cable 9
- Connecting the USB Touchscreen Cable 14
- Connecting the Video Cable (Serial connection) 8
- Connecting the Video Cable (USB connection) 13
- Contrast 25
- Cut Out Dimensions 38

E

- ET1546L 36
- ET1546L Rear Mount Plate Cut Out 38

H

- Horizontal Attachment 39

I

- Image problem 27
- Image, scrolling 28
- Image, unstable 28
- Image, vertical flickering 28
- Installation and Setup 3
- Installing the Driver Software 18
- Installing the Serial Touch Driver for MS-DOS and Windows 3.1 20
- Installing the Serial Touch Driver for Windows XP, Windows 2000, Me, 95/98 and NT 4.0 19

- Installing the USB Touch Driver 21
- Installing the USB Touch Driver for Windows 98 and Windows 2000 21
- IntelliTouch Touchmonitor Specifications 35
- Introduction 1

M

- Main Unit (1545L) 4

N

- Native Resolution 29

O

- Operation 23
- Optimizing the LCD Display 17
- OSD Language 25
- OSD Menu Function 25
- Out of Range display 27

P

- Phase/Clock 25
- Position 25
- Precautions 1
- Product Overview 4
- Product Overview (1567L) 6

R

- Rear View (1545L) 4
- Rear View (1567L) 6
- Recall 25
- Regulatory Information 43
- Remote OSD Buttons 24

S

- Serial Connection 7
- Side View (1567L) 6
- Solutions to Common Problems 27

T

- Technical Specifications 33
- Touch Interface Connection 7
- Touch not working 28
- Touchmonitor Safety 31
- Touchmonitor Specifications ET1546L 34
- Troubleshooting 27

U

Unpacking Your Touchmonitor 3

USB Connection 12

Using the On-Screen Display Menus 23

V

Vertical Attachment 39

VESA Mount on Your Touchmonitor 17

W

Warranty 41

Without Brackets 40