

JVC



COMPACT COMPONENT SYSTEM

CA-HXZ1R CA-HXZ1

CA-HXZ1R

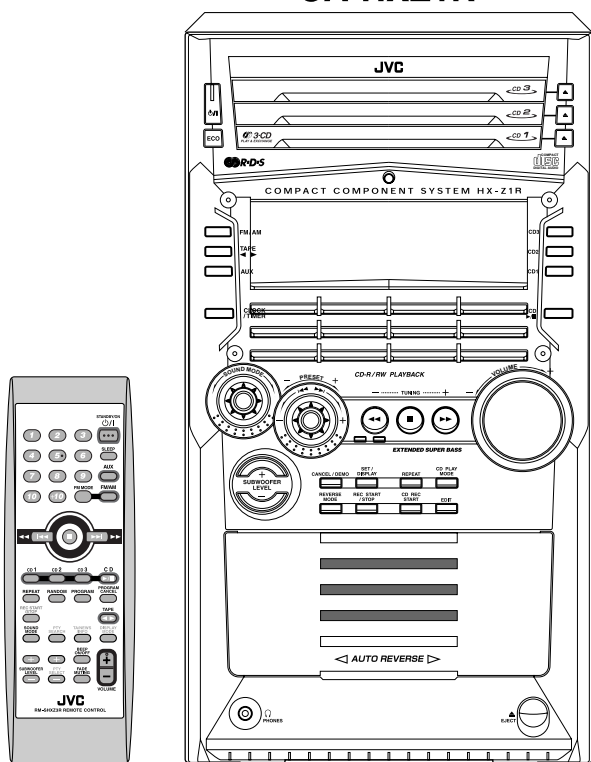

CA-HXZ1

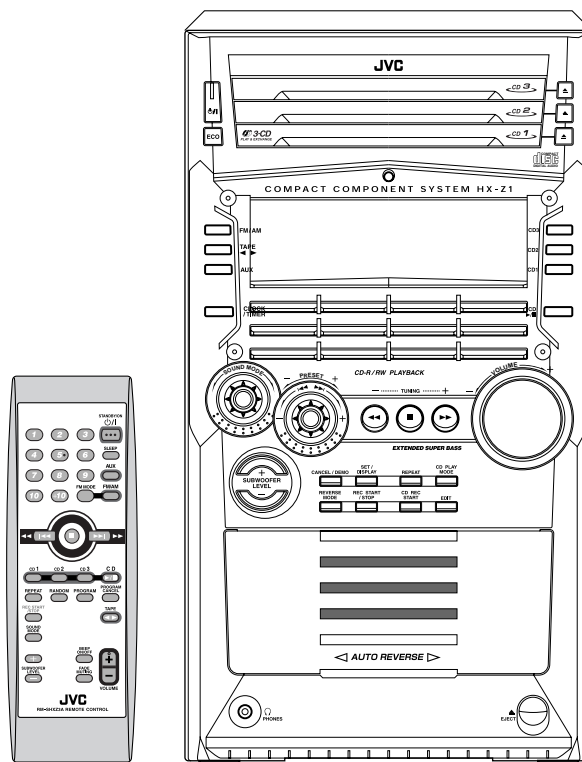

COMPACT
disc
DIGITAL AUDIO

COMPACT
disc
DIGITAL AUDIO

INSTRUCTIONS

For Customer Use:

Enter below the Model No. and Serial No. which are located either on the rear, bottom or side of the cabinet. Retain this information for future reference.

Model No. _____

Serial No. _____

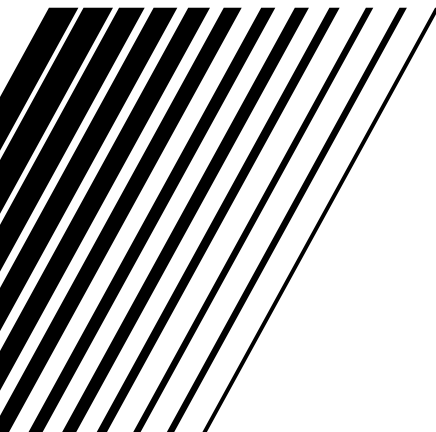

Warnings, Cautions and Others

IMPORTANT for the U.K.

DO NOT cut off the mains plug from this equipment. If the plug fitted is not suitable for the power points in your home or the cable is too short to reach a power point, then obtain an appropriate safety approved extension lead or consult your dealer.

BE SURE to replace the fuse only with an identical approved type, as originally fitted.

If nonetheless the mains plug is cut off ensure to remove the fuse and dispose of the plug immediately, to avoid a possible shock hazard by inadvertent connection to the mains supply.

If this product is not supplied fitted with a mains plug then follow the instructions given below:

IMPORTANT:

DO NOT make any connection to the terminal which is marked with the letter E or by the safety earth symbol or coloured green or green-and-yellow.

The wires in the mains lead on this product are coloured in accordance with the following code:

Blue : Neutral
Brown : Live

As these colours may not correspond with the coloured markings identifying the terminals in your plug proceed as follows:

The wire which is coloured blue must be connected to the terminal which is marked with the letter N or coloured black.

The wire which is coloured brown must be connected to the terminal which is marked with the letter L or coloured red.

IF IN DOUBT - CONSULT A COMPETENT ELECTRICIAN.

Caution— (standby/on) button!

Disconnect the mains plug to shut the power off completely. The  (standby/on) button in any position does not disconnect the mains line. The power can be remote controlled.

Caution

To reduce the risk of electrical shocks, fire, etc.:

1. Do not remove screws, covers or cabinet.
2. Do not expose this appliance to rain or moisture.

IMPORTANT FOR LASER PRODUCTS

REPRODUCTION OF LABELS

- ① CLASSIFICATION LABEL, PLACED ON REAR ENCLOSURE

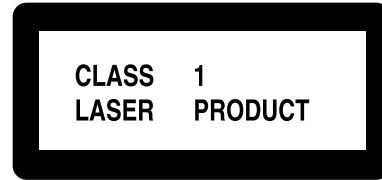

- ② WARNING LABEL, PLACED INSIDE THE UNIT

DANGER : Invisible laser radiation when open and interlock failed or defeated. AVOID DIRECT EXPOSURE TO BEAM. (e)	VARNING : Osynlig laserstrålning när denna del är öppnad och spärren är urkopplad. Beträkta ej strålen. (s)
--	--

ADVARSEL : Usynlig laserstrålning ved åbning, når sikkerhedsafbrydere er ude af funktion. Undgåudsættelse for stråling. (d)	VARO : Avattaessa ja suojaelukitus ohitettaessa olet alttiina näkymättömälle lasersäteilylle. Älä katso säteeseen. (f)
--	---

1. CLASS 1 LASER PRODUCT
2. **DANGER**: Invisible laser radiation when open and interlock failed or defeated. Avoid direct exposure to beam.
3. **CAUTION**: Do not open the top cover. There are no user serviceable parts inside the Unit; leave all servicing to qualified service personnel.

CAUTION

- Do not block the ventilation openings or holes. (If the ventilation openings or holes are blocked by a newspaper or cloth, etc., the heat may not be able to get out.)
- Do not place any naked flame sources, such as lighted candles, on the apparatus.
- When discarding batteries, environmental problems must be considered and local rules or laws governing the disposal of these batteries must be followed strictly.
- Do not expose this apparatus to rain, moisture, dripping or splashing and that no objects filled with liquids, such as vases, shall be placed on the apparatus.

Caution: Proper Ventilation

To avoid risk of electric shock and fire, and to prevent damage, locate the apparatus as follows:

1 Front:

No obstructions and open spacing.

2 Sides/ Top/ Back:

No obstructions should be placed in the areas shown by the dimensions below.

3 Bottom:

Place on the level surface. Maintain an adequate air path for ventilation by placing on a stand with a height of 10 cm or more.

Front view

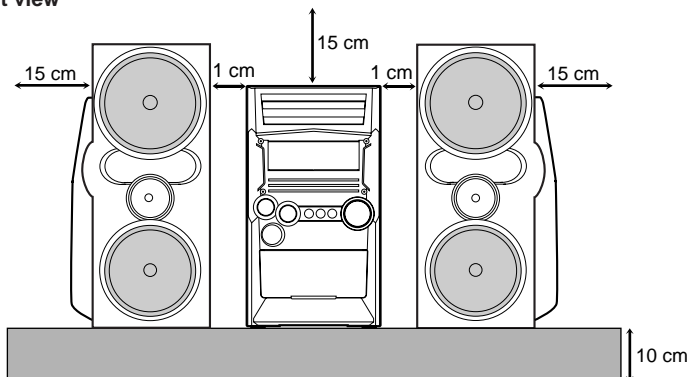

Side view

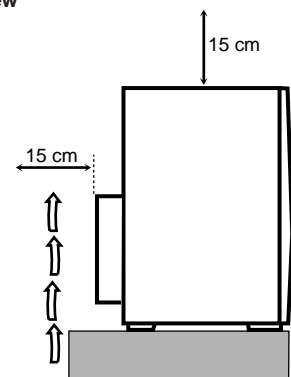

SAFETY INSTRUCTIONS

“SOME DOS AND DON'TS ON THE SAFE USE OF EQUIPMENT”

This equipment has been designed and manufactured to meet international safety standards but, like any electrical equipment, care must be taken if you are to obtain the best results and safety is to be assured.

Do read the operating instructions before you attempt to use the equipment.

Do ensure that all electrical connections (including the mains plug, extension leads and interconnections between pieces of equipment) are properly made and in accordance with the manufacturer's instructions. Switch off and withdraw the mains plug when making or changing connections.

Do consult your dealer if you are ever in doubt about the installation, operation or safety of your equipment.

Do be careful with glass panels or doors on equipment.

DON'T continue to operate the equipment if you are in any doubt about it working normally, or if it is damaged in any way — switch off, withdraw the mains plug and consult your dealer.

DON'T remove any fixed cover as this may expose dangerous voltages.

DON'T leave equipment switched on when it is unattended unless it is specifically stated that it is designed for unattended operation or has a standby mode.

Switch off using the switch on the equipment and make sure that your family know how to do this.

Special arrangements may need to be made for infirm or handicapped people.

DON'T use equipment such as personal stereos or radios so that you are distracted from the requirements of traffic safety. It is illegal to watch television whilst driving.

DON'T listen to headphones at high volume as such use can permanently damage your hearing.

DON'T obstruct the ventilation of the equipment, for example with curtains or soft furnishings.

Overheating will cause damage and shorten the life of the equipment.

DON'T use makeshift stands and NEVER fix legs with wood screws — to ensure complete safety always fit the manufacturer's approved stand or legs with the fixings provided according to the instructions.

DON'T allow electrical equipment to be exposed to rain or moisture.

ABOVE ALL

- NEVER let anyone, especially children, push anything into holes, slots or any other opening in the case — this could result in a fatal electrical shock.
- NEVER guess or take chances with electrical equipment of any kind — it is better to be safe than sorry!

Introduction

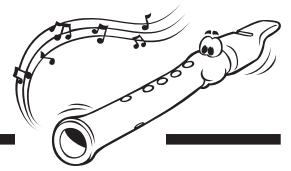

We would like to thank you for purchasing one of our JVC products. Before operating this unit, read this manual carefully and thoroughly to obtain the best possible performance from your unit, and retain this manual for future reference.

About This Manual

This manual is organized as follows:

- The manual mainly explains operations using the buttons and controls on the unit. You can also use the buttons on the remote control if they have the same or similar names (or marks) as those on the unit. If operation using the remote control is different from that using the unit, it is then explained.
- Basic and common information that is the same for many functions is grouped in one place, and is not repeated in each procedure. For instance, we do not repeat the information about turning on/off the unit, setting the volume, changing the sound effects, and others, which are explained in the section “Common Operations” on pages 10 to 12.
- The following marks are used in this manual:



Gives you warnings and cautions to prevent from damage or risk of fire/electric shock. Also gives you information which is not good for obtaining the best possible performance from the unit.



Gives you information and hints you had better know.

Precautions

Installation

- Install in a place which is level, dry and neither too hot nor too cold—between 5°C and 35°C.
- Install the unit in a location with adequate ventilation to prevent internal heat buildup in the unit.
- Leave sufficient distance between the unit and the TV.
- Keep the speakers away from the TV to avoid interference with TV.



DO NOT install the unit in a location near heat sources, or in a place subject to direct sunlight, excessive dust or vibration.

Power sources

- When unplugging from the wall outlet, always pull the plug, not the AC power cord.



DO NOT handle the AC power cord with wet hands.

Moisture condensation

Moisture may condense on the lens inside the unit in the following cases:

- After heating start in the room
 - In a damp room
 - If the unit is brought directly from a cold to a warm place
- Should this occur, the unit may malfunction. In this case, leave the unit turned on for a few hours until the moisture evaporates, unplug the AC power cord, and then plug it in again.

Internal heat

A cooling fan is mounted on the rear panel to prevent heat buildup inside the unit.



For safety, observe the following carefully:

- Make sure there is good ventilation around the unit. Poor ventilation could overheat and damage the unit.
- DO NOT block the cooling fan and the ventilation openings or holes. If they are blocked by a newspaper or cloth, etc., the heat may not be able to get out.

Others

- Should any metallic object or liquid fall into the unit, unplug the unit and consult your dealer before operating any further.
- If you are not going to operate the unit for an extended period of time, unplug the AC power cord from the wall outlet.



DO NOT disassemble the unit since there are no user serviceable parts inside.

If anything goes wrong, unplug the AC power cord and consult your dealer.

Contents

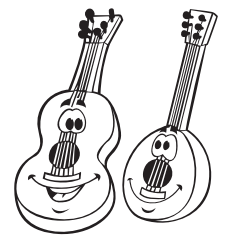

Location of the Buttons and Controls	3	Playing Back CDs (CD/CD-R/CD-RW)	16
Front Panel	3	Loading CDs	16
Remote Control	5	Playing Back the Entire Discs—Continuous Play ...	17
Getting Started	7	Basic CD Operations	17
Supplied Accessories	7	Programming the Playing Order of the Tracks	
Putting the Batteries into the Remote Control	7	—Program Play	18
Connecting Antennas	7	Playing at Random—Random Play	19
Connecting Speakers	8	Repeating Tracks or CDs—Repeat Play	20
Connecting Other Equipment	9	Prohibiting Disc Ejection—Tray Lock	20
Canceling the Demonstration	9	Playing Back Tapes	21
Common Operations	10	Playing Back a Tape	21
Turning On or Off the Power	10	Locating the Beginning of a Song—Music Scan	21
Saving the Power Consumption while on Standby		Recording	22
—Ecology Mode	10	Recording on a Tape	22
Setting the Clock	10	CD Synchronized Recording	23
Selecting the Sources	11	■ CD Direct Recording	23
Adjusting the Volume	11	■ Auto Edit Recording	24
Reinforcing the Bass Sound	11	Using the Timers	25
Selecting the Sound Modes	11	Using Daily Timer	25
Creating Your Own Sound Mode—User Mode	12	Using Recording Timer	27
Turning On or Off the Key-touch Tone	12	Using Sleep Timer	28
Listening to FM and AM Broadcasts	13	Timer Priority	28
Tuning in to a Station	13	Additional Information	29
Presetting Stations	13	Maintenance	30
Tuning in to a Preset Station	13	Troubleshooting	31
Receiving FM Stations with RDS		Specifications	32
(Only for CA-HXZ1R)	14		
Changing the RDS information	14		
Searching for Programs by PTY Codes			
(PTY Search)	14		
Switching to a Program Type of Your Choice			
Temporarily	15		

Location of the Buttons and Controls

Become familiar with the buttons and controls on your unit.

Front Panel

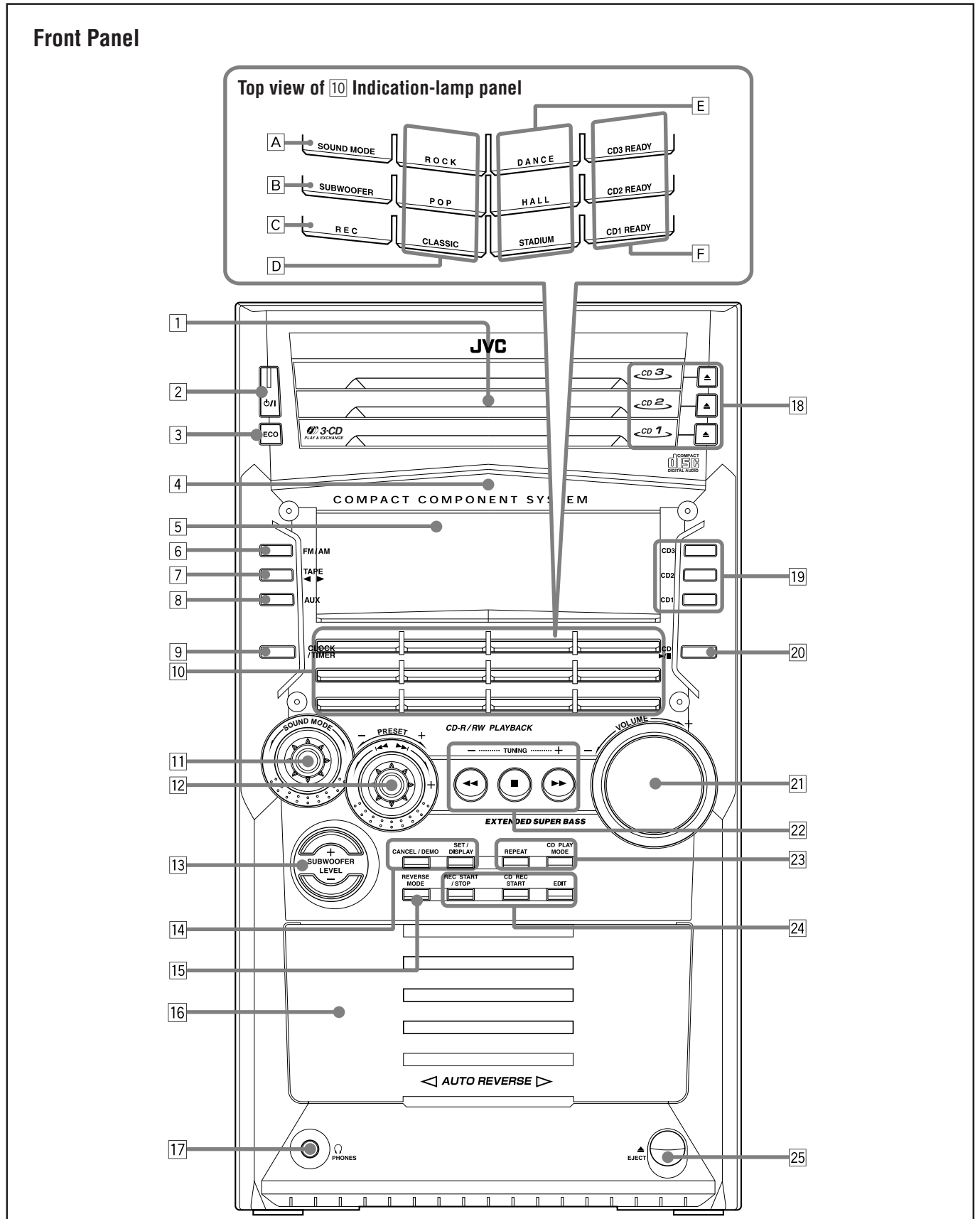

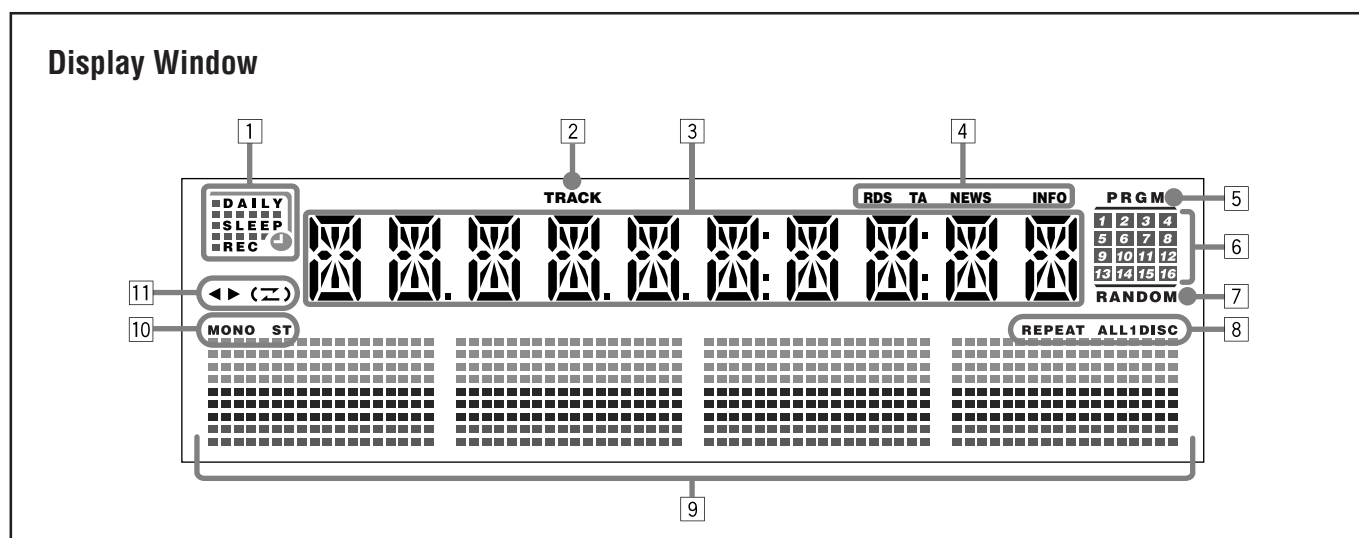

See pages in the parentheses for details.

Front Panel

- 1 Disc trays
- 2 \mathcal{O}/I (standby/on) button and lamp (10, 26, 27)
- 3 ECO (Ecology) button (10)
- 4 Remote sensor
- 5 Display window
- 6 FM/AM button (11, 13)
Pressing this button also turns on the unit.
- 7 TAPE $\blacktriangleleft/\blacktriangleright$ button (11, 21, 22)
Pressing this button also turns on the unit.
- 8 AUX button (11)
Pressing this button also turns on the unit.
- 9 CLOCK/TIMER button (10, 25 – 28)
- 10 Indication-lamp panel
 - A SOUND MODE lamp (11)
 - B SUBWOOFER lamp (11)
 - C REC (recording) lamp (22 – 24)
 - D SEA (Sound Effect Amplifier) mode lamps (11)
 - ROCK, POP, and CLASSIC lamps
 - E Surround mode lamps (11)
 - DANCE, HALL, and STADIUM lamps
 - F CD ready lamps (16)
 - CD1 READY, CD2 READY, and CD3 READY lamps
- 11 SOUND MODE control (11)
- 12 PRESET + / – control (13)
 - $\blacktriangleleft/\blacktriangleright$ (reverse skip/forward skip) control (10, 12, 17 – 19, 24 – 27)
- 13 SUBWOOFER LEVEL + / – buttons (11)
- 14 Setting buttons (9, 10, 12, 13, 18, 19, 24 – 28)
 - CANCEL/DEMO and SET/DISPLAY buttons
- 15 REVERSE MODE button (21 – 24)
- 16 Cassette holder (21 – 24)
- 17 PHONES (\mathcal{Q}) jack (11)
- 18 \blacktriangle (Disc tray open/close) (CD1, CD2, and CD3) buttons (16, 17, 20)
Pressing one of these buttons also turns on the unit.

- 19 Disc number (CD1, CD2, and CD3) buttons (17, 18, 23, 24)
Pressing one of these buttons also turns on the unit.
- 20 CD $\blacktriangleright/\parallel$ button (11, 17 – 19, 24)
Pressing this button also turns on the unit.
- 21 VOLUME + / – control (11)
- 22 TUNING + / – buttons (13)
 - $\blacktriangleleft/\blacktriangleright$ (reverse search/forward search) buttons (12, 17, 21)
 - \blacksquare (stop) button (17 – 24, 27)
- 23 CD play mode buttons (18 – 20)
 - REPEAT and CD PLAY MODE buttons
- 24 Recording buttons (22 – 24, 27)
 - REC START/STOP, CD REC START, and EDIT buttons
- 25 \blacktriangle EJECT button for cassette deck (21 – 23)

Display Window

- 1 Timer indicators
 - DAILY (Daily Timer), SLEEP (Sleep Timer), REC (Recording Timer), and \mathcal{O} (Timer) indicators
- 2 TRACK indicator
- 3 Main display
 - Shows the source name, frequency, etc.
- 4 RDS operation indicators: Only for CA-HXZ1R
RDS, TA, NEWS, and INFO indicators
- 5 PRGM (program) indicator
- 6 CD track number (1 – 16) indicators
- 7 RANDOM indicator
- 8 REPEAT (ALL/1/DISC) indicators
- 9 Audio level indicator
When one of the 6 preset sound modes is activated, these will function as display illumination. For details, see “Selecting the Sound Modes” on pages 11 and 12.
- 10 Tuner operation indicators
 - MONO and ST (stereo) indicators
- 11 Tape operation indicators
 - $\blacktriangleleft/\blacktriangleright$ (tape direction) and \mathcal{Z} (reverse mode) indicators

Remote Control

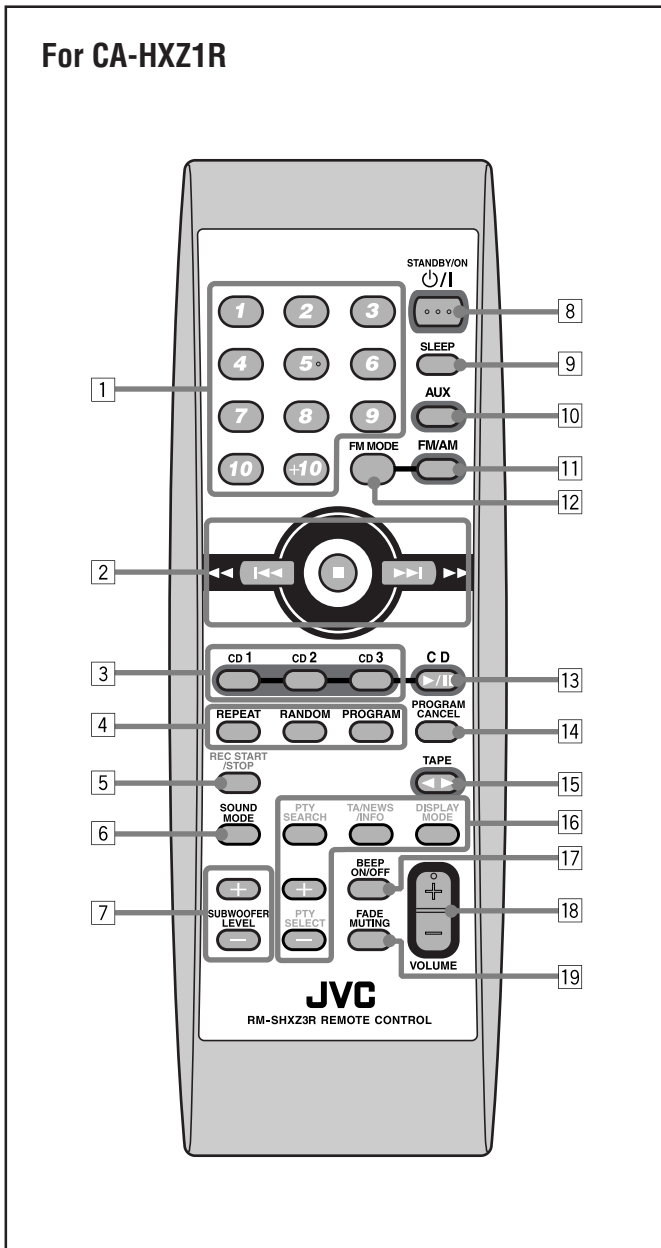

- 1 Number buttons (13, 17, 18)
- 2 ◀◀ (◀◀) (reverse skip/reverse search) button (13, 17, 19, 21)
 - (stop) button (17 – 19, 21 – 24, 27)
 - ▶▶ (▶▶) (forward skip/forward search) button (13, 17, 19, 21)
- 3 Disc number (CD1, CD2, and CD3) buttons (17, 18)
- 4 CD play mode buttons (18 – 20)
 - REPEAT, RANDOM and PROGRAM buttons
- 5 REC START/STOP button (22, 24, 27)
- 6 SOUND MODE button (11)
- 7 SUBWOOFER LEVEL +/- buttons (11)
- 8 STANDBY/ON ⏻/⏻ button (10)
- 9 SLEEP button (28)
- 10 AUX button (11)
- 11 FM/AM button (11, 13)
- 12 FM MODE button (13)
- 13 CD ▶/⏻ button (11, 17 – 19)
- 14 PROGRAM CANCEL button (19)
- 15 TAPE ◀▶ button (11, 21, 22)
- 16 RDS operation buttons
 - PTY SEARCH button (14)
 - TA/NEWS/INFO button (15)
 - DISPLAY MODE button (14)
 - PTY SELECT +/- buttons (14)
- 17 BEEP ON/OFF button (9, 12)
- 18 VOLUME +/- button (11)
- 19 FADE MUTING button (11)



For CA-HXZ1

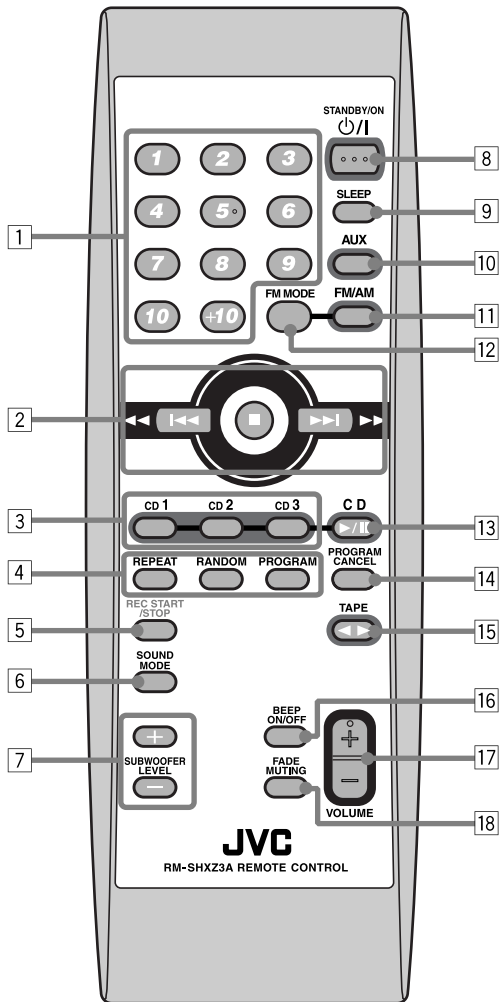

- 1 Number buttons (13, 17, 18)
- 2 ◀◀ (◀◀) (reverse skip/reverse search) button (13, 17, 19, 21)
 - (stop) button (17 – 19, 21 – 24, 27)
 - ▶▶ (▶▶) (forward skip/forward search) button (13, 17, 19, 21)
- 3 Disc number (CD1, CD2, and CD3) buttons (17, 18)
- 4 CD play mode buttons (18 – 20)
 - REPEAT, RANDOM and PROGRAM buttons
- 5 REC START/STOP button (22, 24, 27)
- 6 SOUND MODE button (11)
- 7 SUBWOOFER LEVEL + / – buttons (11)
- 8 STANDBY/ON ⏻/⏻ button (10)
- 9 SLEEP button (28)
- 10 AUX button (11)
- 11 FM/AM button (11, 13)
- 12 FM MODE button (13)
- 13 CD ▶/⏻ button (11, 17 – 19)
- 14 PROGRAM CANCEL button (19)
- 15 TAPE ◀▶ button (11, 21, 22)
- 16 BEEP ON/OFF button (9, 12)
- 17 VOLUME + / – button (11)
- 18 FADE MUTING button (11)

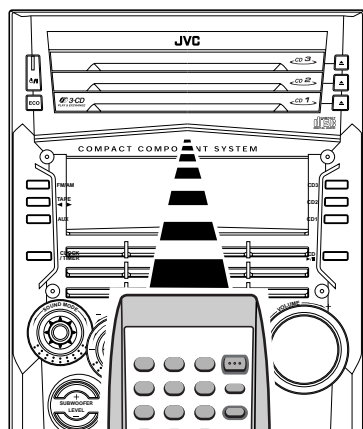

When using the remote control, point it at the remote sensor on the front panel.

Getting Started

Supplied Accessories

Make sure that you have all the following items. The number in the parentheses indicates the quantity of the pieces supplied.

- AM loop antenna (1)
- FM antenna (1)
- Remote control (1)
- Batteries (2)

If anything is missing, consult your dealer immediately.

Putting the Batteries into the Remote Control

Insert the batteries—R6(SUM-3)/AA(15F)—into the remote control, by matching the polarity (+ and –) on the batteries with the + and – markings on the battery compartment. When the remote control can no longer operate the unit, replace both batteries at the same time.

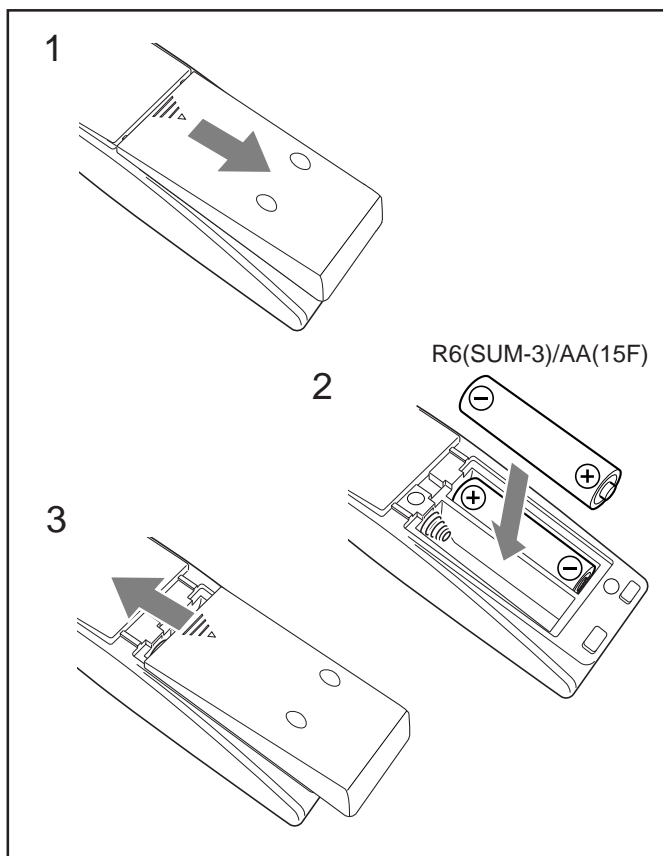

- DO NOT use an old battery together with a new one.
- DO NOT use different types of batteries together.
- DO NOT expose batteries to heat or flame.
- DO NOT leave the batteries in the battery compartment when you are not going to use the remote control for an extended period of time. Otherwise, it will be damaged from battery leakage.

Connecting Antennas

FM antenna

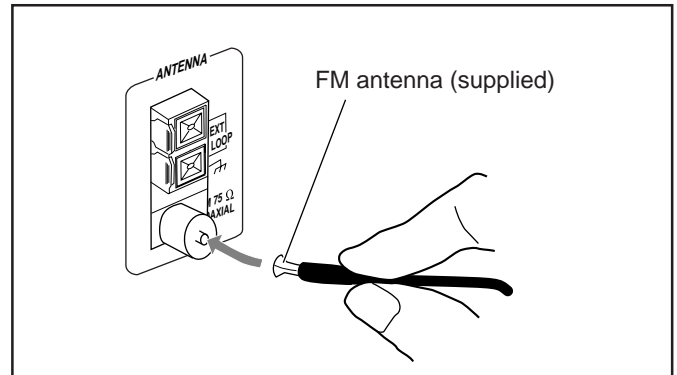

- 1 Attach the FM antenna to the FM 75 Ω COAXIAL terminal.
- 2 Extend the FM antenna.
- 3 Fasten it up in the position which gives you the best reception, then fix it on the wall, etc.



About the supplied FM antenna

The FM antenna supplied with this unit can be used as temporary measure. If reception is poor, you can connect an outdoor FM antenna.

To connect an outdoor FM antenna

Before connecting it, disconnect the supplied FM antenna.

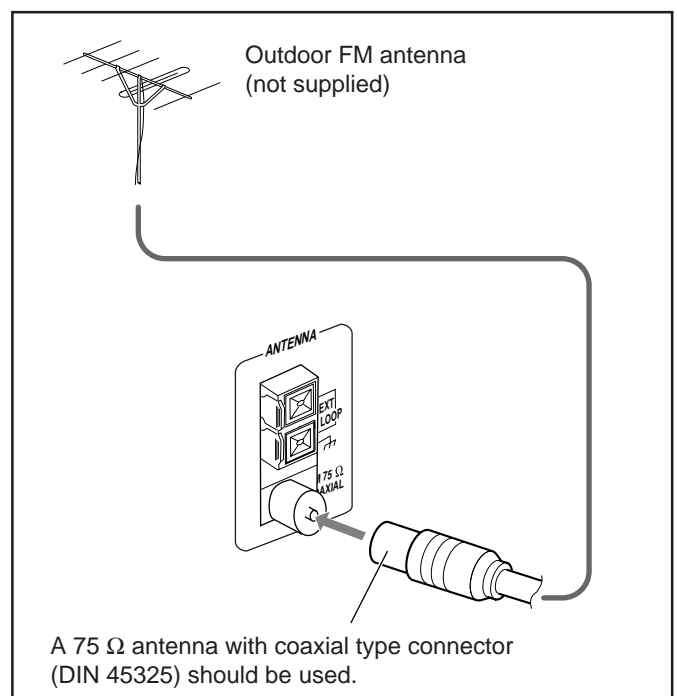

AM antenna

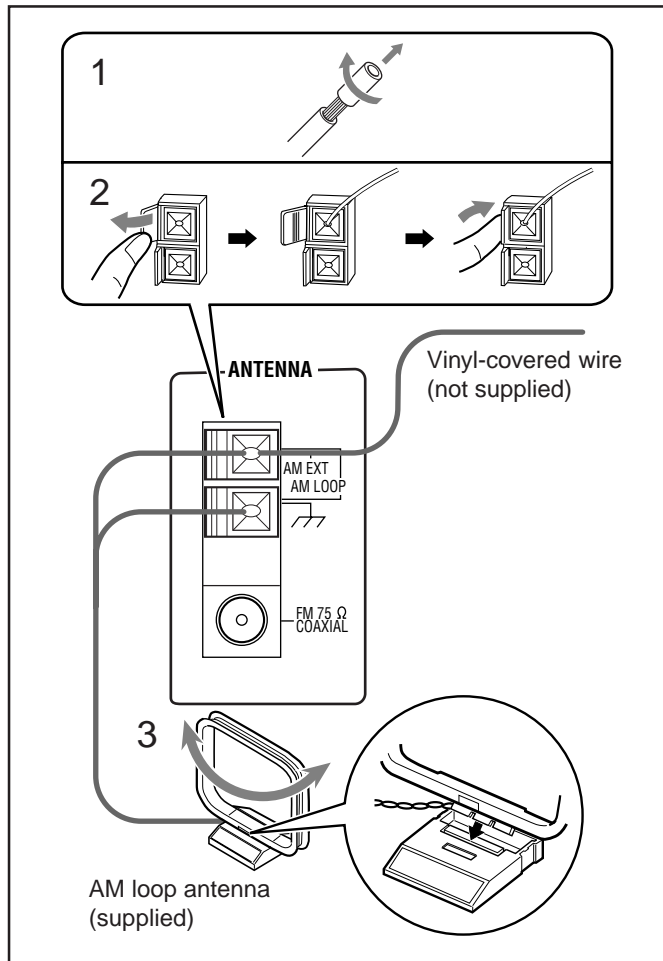

- 1 If cords are covered with insulation, twist the core of the cord at the end of each cord, then remove the insulation.
- 2 Connect the AM loop antenna to the AM LOOP terminals as illustrated.
- 3 Turn the AM loop antenna until you have the best reception.

To connect an outdoor AM antenna

When reception is poor, connect a single vinyl-covered wire to the AM EXT terminal and extend it horizontally. The AM loop antenna must remain connected.



For better reception of both FM and AM

- Make sure the antenna conductors do not touch any other terminals and connecting cords.
- Keep the antennas away from metallic parts of the unit, connecting cords, and the AC power cord.

Connecting Speakers

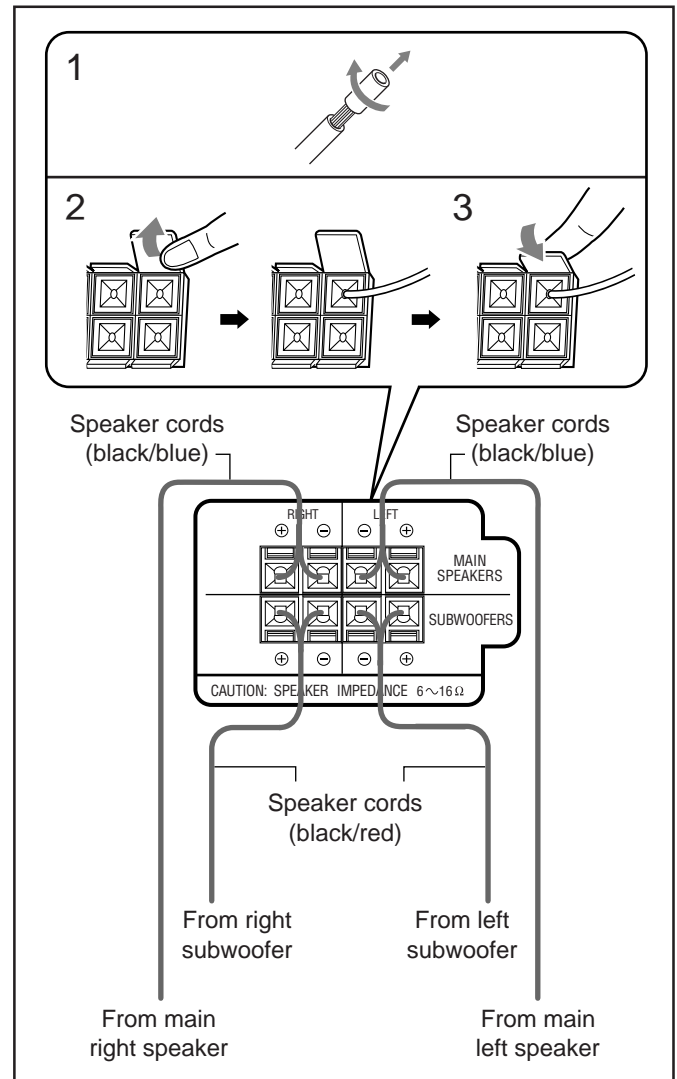

- 1 If cords are covered with insulation, twist the core of the cord at the end of each cord, then remove the insulation.
- 2 Insert the end of the speaker cord into the terminal as illustrated.
Match the same polarity: (+) to (+) and (-) to (-).
- 3 Close the speaker terminals.

IMPORTANT: Use only speakers with the same speaker impedance as indicated by the speaker terminals on the rear of the unit.



- DO NOT connect more than one speaker to each speaker terminal.
- DO NOT push or pull the speakers as this will damage the foot spacers at the bottom of the speakers.



Connecting Other Equipment

You can connect both analog and digital equipment.



- DO NOT connect any equipment while the power is on.
- DO NOT plug in any equipment until all connections are complete.

To connect an analog component

Be sure that the plugs of the audio cords are colored: White plugs and jacks are for left audio signals, and red ones for right audio signals.

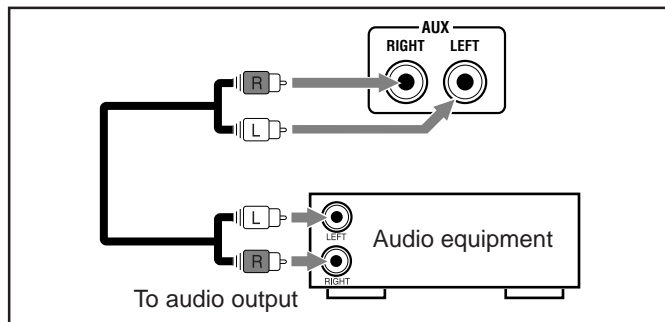

For playing the other equipment through this unit, connect between the audio output jacks on the other equipment and AUX jacks by using audio cords (not supplied).

To connect audio equipment with an optical digital input terminal

You can record CD sound onto the connected digital equipment.

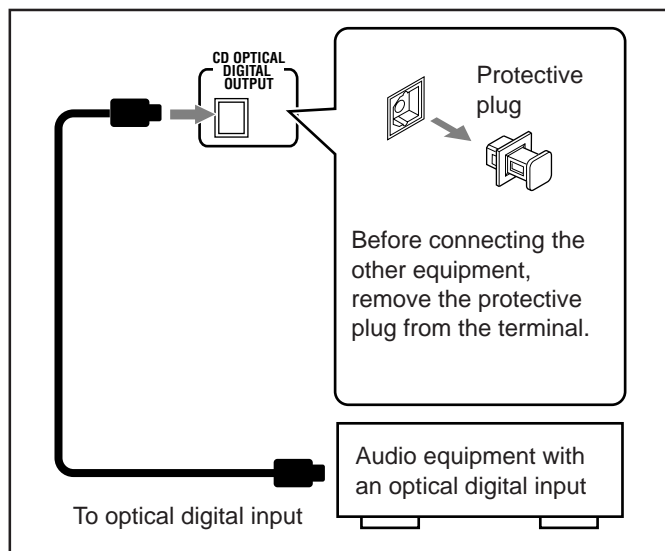

Connect an optical digital cord (not supplied) between the optical digital input terminal on the other equipment and the CD OPTICAL DIGITAL OUTPUT terminal.

Now, you can plug the AC power cord.

IMPORTANT: Be sure to check all connections to be done before plugging the AC power cord into a wall outlet.

Canceling the Demonstration

When connecting the AC power cord into a wall outlet, the unit automatically starts the demonstration.

To cancel the demonstration, press and hold CANCEL/DEMO until “DEMO OFF” appears on the display.

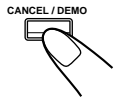

- To cancel only beep sounds during the demonstration, press BEEP ON/OFF on the remote control.





When you press other buttons

The demonstration stops temporarily. It will start automatically again (if no operation is done for 2 minutes) unless you cancel it by pressing CANCEL/DEMO.

To start the demonstration manually



Press and hold CANCEL/DEMO again until “DEMO START” appears on the display.

Turning On or Off the Power

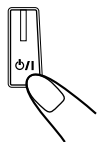
To turn on the unit, press  (or STANDBY/ON  on the remote control) so that the lamp on the button goes off.



POWER ON

To turn off the unit (on standby), press  (or STANDBY/ON  on the remote control) again so that the lamp on the button lights up.

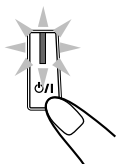

- A little power is always consumed even while the unit is on standby.

To switch off the power supply completely, unplug the AC power cord from the AC outlet.



When you unplug the AC power cord or if a power failure occurs

The clock is reset to “0:00” right away, while the tuner preset stations (see page 13) will be erased in a few days.

Saving the Power Consumption while on Standby —Ecology Mode

You can save the power consumption while the unit is turned off (on standby).

- You can set Ecology Mode whether the unit is on or off.

On the unit ONLY:

To activate the Ecology Mode, press ECO. “ECO” appears on the display for 2 seconds (and demonstration is canceled temporarily if you have pressed the button while the unit is off).



- Each time you press the button, “ECO” and “NORMAL” appear alternately on the display.

To deactivate the Ecology Mode, press ECO again. “NORMAL” appears (and demonstration starts if the unit is turned off).



When you turn off the unit with Ecology Mode activated

“ECO” flashes on the display, and the clock time will not be shown while the unit is turned off.

Setting the Clock

You can set the clock whether the unit is on or off; however, if Ecology Mode is activated, you cannot set the clock while the unit is off. “0:00” flashes on the display until you set the clock.

On the unit ONLY:

1 Press CLOCK/TIMER.

The hour digits start flashing on the display.



2 Turn / to adjust the hour, then press SET/DISPLAY.

The minute digits start flashing on the display.

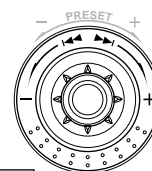

If you want to correct the hour after pressing SET/DISPLAY, press CANCEL/DEMO.



The hour digits start flashing again.

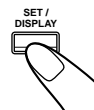

3 Turn / to adjust the minute, then press SET/DISPLAY.

CLOCK OK

To check the clock time

Press and hold SET/DISPLAY while playing any source.

- Each time you press and hold the button, the source indication and the clock time alternate on the display.

To adjust the clock again

If you have set the clock before, you need to press CLOCK/TIMER repeatedly until the clock setting mode is selected.

- Each time you press the button, the clock/timer setting modes change as follows:

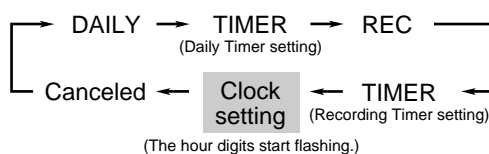

When you unplug the AC power cord or if a power failure occurs

The clock loses the setting and is reset to “0:00.” You need to set the clock again.

Selecting the Sources

To listen to the FM/AM broadcasts, press FM/AM.

(See page 13.)

To play back CDs, press CD ►/II. (See pages 16 – 20.)

To play back tapes, press TAPE ◀▶. (See page 21.)

To select the external equipment as the source, press AUX.



When you press the play button for a particular source (FM/AM, CD ►/II, TAPE ◀▶, and AUX), the unit turns on and the unit starts playing the source if it is ready.

Adjusting the Volume

You can adjust the volume level only while the unit is turned on. The volume level can be adjusted in 32 steps (VOLUME MIN, VOLUME 1 – VOLUME 30, and VOLUME MAX).

Turn VOLUME + / – clockwise (+) to increase the volume or counterclockwise (–) to decrease it.

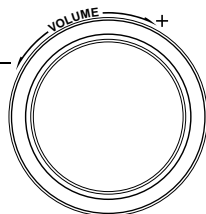

When using the remote control, press VOLUME + to increase the volume or VOLUME – to decrease it.

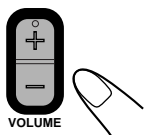

For private listening

Connect a pair of headphones to the PHONES (🎧) jack. No sound comes out of the speakers. Be sure to turn down the volume before connecting or putting on headphones.



DO NOT turn off (on standby) the unit with the volume set to an extremely high level; otherwise, a sudden blast of sound can damage your hearing, speakers and/or headphones when you turn on the unit or start playing any source next time. REMEMBER you cannot adjust the volume level while the unit is on standby.

To turn down the volume level temporarily On the remote control ONLY:

Press FADE MUTING.

The volume level gradually decreases to “VOLUME MIN.”



To restore the sound, press the button again.

Reinforcing the Bass Sound

You can select one of the 5 subwoofer levels. This function only affects the playback sound, but does not affect your recording. The subwoofer level can be adjusted in 5 steps—LEVEL 0 (MIN LEVEL), LEVEL 1, LEVEL 2, LEVEL 3, and LEVEL 4 (MAX LEVEL).

Press SUBWOOFER LEVEL + to increase the subwoofer level or SUBWOOFER LEVEL – to decrease it.



SUBWOOFER lamp lights up in red.

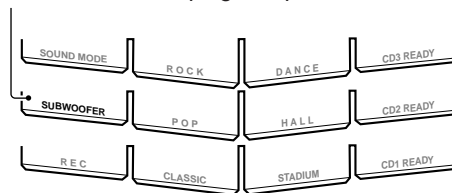

- The SUBWOOFER lamp lights up in red when LEVEL 1 to LEVEL 4 (MAX LEVEL) is selected. The lamp lights off when LEVEL 0 (MIN LEVEL) is selected.

Selecting the Sound Modes

You can select one of the 6 preset sound modes (3 surround modes and 3 SEA—Sound Effect Amplifier—modes) and 3 user modes. This function only affects the playback sound, but does not affect your recording. Each Sound Mode has its own display illumination.

To select the sound modes, turn SOUND MODE (or press SOUND MODE on the remote control) until the sound mode you want appears on the display.

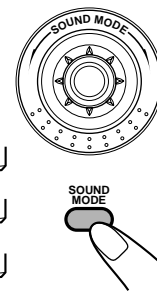
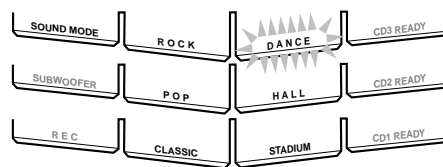

- When a sound mode is selected (for this example DANCE), the SOUND MODE lamp and other than the selected sound mode lamps light up. While the selected sound mode lamp flashes. (If USER 1, USER 2, and USER 3 is selected, only the SOUND MODE lamp lights up. If OFF is selected, the SOUND MODE lamp and other sound mode lamps go off.)

The sound modes change as follows:

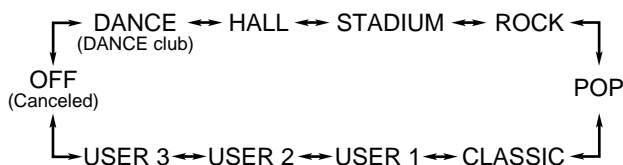

When using the remote control, the sound mode changes clockwise in the above sequence.

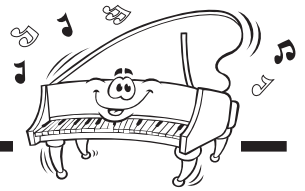

Surround modes*

- DANCE:** Increases resonance and bass.
HALL: Adds depth and brilliance to the sound.
STADIUM: Adds clarity and spreads the sound, like in an outdoor stadium.

SEA (Sound Effect Amplifier) modes

- ROCK:** Boosts low and high frequency. Good for acoustic music.
POP: Good for vocal music.
CLASSIC: Good for classical music.

User Modes

USER 1/2/3: Your individual mode stored in memory. See “Creating Your Own Sound Mode—User Mode” below.

OFF: The sound mode is canceled.

* Surround elements are added to the SEA elements to create a being-there feeling in your room.

Creating Your Own Sound Mode—User Mode

You can change SEA pattern to suit your preference. The SEA pattern can be adjusted into 5 frequency range—LOW1, LOW2, MID, HIGH1, and HIGH2. These changed settings can be stored in the USER 1, USER 2, and USER 3 modes.

- There is a time limit in doing the following steps. If the setting is canceled before you finish, start from step 1 again.

On the unit ONLY:

1 Select one of the preset sound modes.

- If you want to add the surround elements in your SEA pattern, select one of the surround modes (DANCE, HALL, or STADIUM) before starting the procedure below. (See “Selecting the Sound Modes” on page 11.)

2 Press SET/DISPLAY while the selected sound mode is still shown on the display.

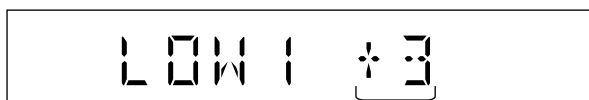
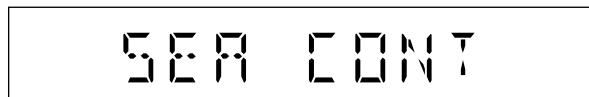
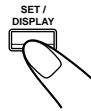

Current level appears.

3 Adjust the SEA pattern.

- 1) Turn |◀◀ / ▶▶| to select the frequency range (LOW1, LOW2, MID, HIGH1, and HIGH2).
- 2) Press ◀◀ or ▶▶ to adjust the level (-3 to +3) of the selected frequency range.
- 3) Repeat steps 1) and 2) to adjust the level of the other frequency ranges.

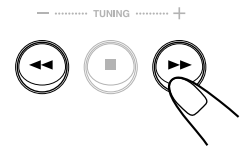
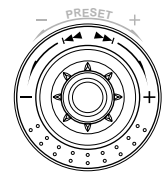

4 Press SET/DISPLAY again.

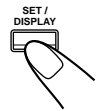

USER 1

5 Turn |◀◀ / ▶▶| to select one of the user modes (USER 1, USER 2, and USER 3) which you want to store the SEA pattern.

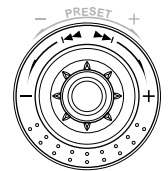

6 Press SET/DISPLAY again.

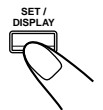

MEMORY

The SEA pattern you have created are stored into the user mode selected in the above step.

To use your own sound mode

Select USER 1, USER 2, or USER 3 mode when using the sound modes. See “Selecting the Sound Modes” on page 11.



When you unplug the AC power cord or if a power failure occurs

The setting will be erased in a few days. If this happens, set the user modes again.

Turning On or Off the Key-touch Tone

If you do not want the key-touch tone to beep each time you press a button, you can deactivate it.

On the remote control ONLY:

Press BEEP ON/OFF.

- Each time you press the button, the key-touch tone turns on and off alternately.



Listening to FM and AM Broadcasts



Tuning in to a Station

1 Press FM/AM.

The unit automatically turns on and tunes in to the previously tuned station (either FM or AM).

- Each time you press the button, the band alternates between FM and AM.

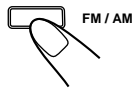

2 Start searching for stations.

On the unit:

Press and hold **TUNING +** or **TUNING -** for more than 1 second.

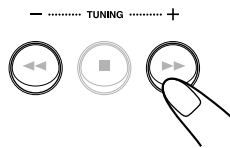

On the remote control:

Press and hold **▶▶▶ (▶▶▶)** or **◀◀◀ (◀◀◀)** for more than 1 second.

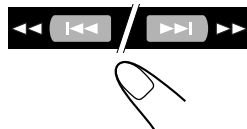

The unit starts searching for stations and stops when a station of sufficient signal strength is tuned in.

- If a program is broadcast in stereo, the ST (stereo) indicator lights up.

To stop searching, press **TUNING +** or **TUNING -** (or **▶▶▶ (▶▶▶) / ◀◀◀ (◀◀◀)** on the remote control).



When you press **TUNING +** or **TUNING -** (or **▶▶▶ (▶▶▶) / ◀◀◀ (◀◀◀)** on the remote control) briefly and repeatedly the frequency changes step by step.

To change the FM reception mode

On the remote control ONLY:

When an FM stereo broadcast is hard to receive or noisy, press **FM MODE** so that the **MONO** indicator lights up on the display. Reception improves.

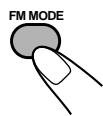

To restore the stereo effect, press **FM MODE** again so that the **MONO** indicator goes off. In this stereo mode, you can hear stereo sounds when a program is broadcasted.

Presetting Stations

You can preset 30 FM and 15 AM stations.

In some cases, test frequencies have been already memorized for the tuner since the factory examined the tuner preset function before shipment. This is not a malfunction. You can preset the stations you want into memory by following the presetting method.

- There is a time limit in doing the following steps. If the setting is canceled before you finish, start from step 2 again.

On the unit ONLY:

1 Tune in to the station you want to preset.

- See “Tuning in to a Station.”

2 Press SET/DISPLAY.

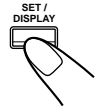

3 Turn PRESET + / - to select a preset number.

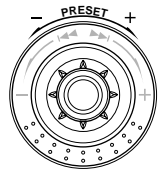
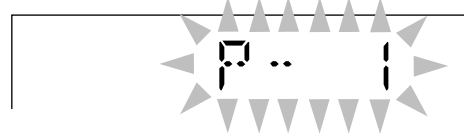

4 Press SET/DISPLAY again.

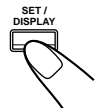

The tuned station in step 1 is stored in the preset number selected in step 3.

- Storing a new station on a used number erases the previously stored one.



When you unplug the AC power cord or if a power failure occurs

The preset stations will be erased in a few days. If this happens, preset the stations again.

Tuning in to a Preset Station

1 Press FM/AM.

The unit automatically turns on and tunes in to the previously tuned station (either FM or AM).

- Each time you press the button, the band alternates between FM and AM.

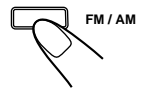

2 Select a preset number.

On the unit:

Turn **PRESET + / -**.

On the remote control:

Press the number buttons.

Ex.: For preset number 5, press 5.

For preset number 15, press +10, then 5.

For preset number 25, press +10, +10, then 5.

For preset number 30, press +10, +10, then 10.

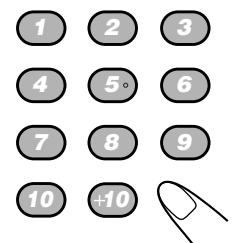
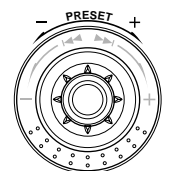

Receiving FM Stations with RDS (Only for CA-HXZ1R)

Continued 

RDS (Radio Data System) allows FM stations to send an additional signal along with their regular program signals. For example, the stations send their station names, as well as information about what type of program they broadcast, such as sports or music, etc.

When tuning in to an FM station which provides the RDS service, the RDS indicator lights up on the display.

With the unit, you can receive the following types of RDS signals.

PS (Program Service):

Shows commonly known station names.

PTY (Program Type):

Shows types of broadcast programs.

RT (Radio Text):

Shows text messages the station sends.

Enhanced Other Networks:

Provides the information about the types of the programs sent by other RDS stations.



More about RDS

- Some FM stations do not provide RDS signals.
- RDS services vary among FM RDS stations. For details on RDS services in your area, check with local radio stations.
- RDS may not work correctly if the received station is not transmitting the signals properly or if the signal strength is weak.

Changing the RDS Information

You can see RDS information on the display while listening to an FM station.

On the remote control ONLY:

Press DISPLAY MODE.

- Each time you press the button, the display changes to show the following information:

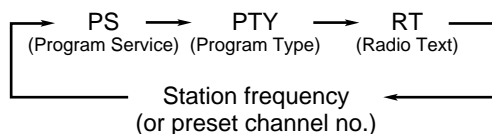

- **If no PS, PTY, or RT signals are sent by a station** “NO PS,” “NO PTY,” or “NO RT” appears on the display.
- **If the unit takes time to show the RDS information received from a station** “WAIT PS,” “WAIT PTY,” or “WAIT RT” may appear on the display.

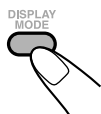

Searching for Programs by PTY Codes (PTY Search)

One of the advantages of RDS is that you can locate a particular kind of program by specifying the PTY codes.

- For details on the PTY codes, see “Additional Information” on page 29.

To search for a program using the PTY codes

REMEMBER you must preset FM RDS stations to use the PTY codes. If not yet done, see page 13.

- There is a time limit in doing the following steps. If the setting is canceled before you finish, start from step 1 again.

On the remote control ONLY:

1 Press PTY SEARCH.

“PTY SELECT” appears on the display.



2 Press PTY SELECT + or PTY SELECT – until the PTY code you want appears on the display.

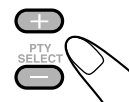

- Each time you press the button, the PTY codes change as follows:

NEWS ⇄ AFFAIRS ⇄ INFO ⇄ SPORT ⇄
 EDUCATE ⇄ DRAMA ⇄ CULTURE ⇄
 SCIENCE ⇄ VARIED ⇄ POP M ⇄ ROCK M ⇄
 EASY M ⇄ LIGHT M ⇄ CLASSICS ⇄
 OTHER M ⇄ WEATHER ⇄ FINANCE ⇄
 CHILDREN ⇄ SOCIAL ⇄ RELIGION ⇄
 PHONE IN ⇄ TRAVEL ⇄ LEISURE ⇄ JAZZ ⇄
 COUNTRY ⇄ NATION M ⇄ OLDIES ⇄
 FOLK M ⇄ DOCUMENT ⇄ TEST ⇄ ALARM ⇄
 (back to the beginning)

3 Press PTY SEARCH once again.

While searching, “SEARCH” and the selected PTY code appear on the display alternately.

The unit searches 30 preset FM stations, stops when it finds the one you have selected (“FOUND” appears), and tunes in to that station.

- If no program is found, “NOT FOUND” appears on the display and the unit returns to the last received station.



To stop searching any time during the process, press PTY SEARCH while searching.

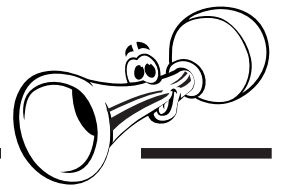

Switching to a Program Type of Your Choice Temporarily

The Enhanced Other Networks function allows the unit to switch temporarily to a broadcast program of your choice (TA, NEWS, or INFO) from a different station.

- The Enhanced Other Networks function only works when you are listening to a preset FM RDS stations providing the data.

To activate the Enhanced Other Networks function

REMEMBER you must preset FM RDS stations to use the function. If not yet done, see page 13.

- There is a time limit in doing the following steps. If the setting is canceled before you finish, start from step **1** again.

On the remote control ONLY:

- 1 Press TA/NEWS/INFO until the data type you want appears on the display.**



The selected data type indicator flashes on the display.



- Each time you press the button, the data types change as follows:



- TA:** Traffic announcement
- NEWS:** News
- INFO:** Program the purpose of which is to impart advice in the widest sense.
- OFF:** The function is canceled. The data type indicator (TA, NEWS, INFO) goes off.

- 2 Wait for about 5 seconds after specifying the data type.**

The data type indicator stops flashing and remains lit. Now, the function is activated. See “How the Enhanced Other Networks function actually works.”

How the Enhanced Other Networks function actually works:

CASE 1

If there is no station broadcasting the program you have selected

The unit continues tuning in to the current station.



When a station starts broadcasting the program you have selected, the unit automatically switches to the station. The indicator of received PTY code starts flashing.



When the program is over, the unit goes back to the previously tuned station, but the function still remains activated.

CASE 2

If there is a station broadcasting the program you have selected

The unit tunes in to the program. The indicator of received PTY code starts flashing.



When the program is over, the unit goes back to the previously tuned station, but the function still remains activated.

CASE 3

If the FM station you are listening to is broadcasting the program you have selected

The unit continues to receive the station but the indicator of received PTY code starts flashing.



When the program is over, the indicator of received PTY code stops flashing and remains lit, but the function still remains activated.



More about the Enhanced Other Networks function

- The data sent from some stations may not be compatible with this unit. In this case, the function may not work correctly.
- While listening to a program tuned in by the function, the station does not change even if another network station starts broadcasting a program of the same data.
- The function is canceled when you change the source to CD, TAPE, or AUX, while it is temporarily canceled when you change the source to AM.
- This function is also canceled when you turn off the unit.

Playing Back CDs (CD/CD-R/CD-RW)

Continued 

This unit has been designed to playback the following CDs:

- CD (Audio CD)
- CD-R (CD-Recordable)
- CD-RW (CD-ReWritable)

Continued use of irregular shape CDs (heart-shape, octagonal, etc.) can damage the unit.

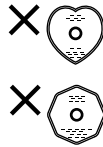

When playing a CD-R or CD-RW

User-edited CD-Rs (CD-Recordable) and CD-RWs (CD-ReWritable) can be played back only if they are already “finalized.”

- You can play back your original CD-Rs or CD-RWs recorded in music CD format. (However, they may not be played back depending on their characteristics or recording conditions.)
- Before playing back CD-Rs or CD-RWs, read their instructions or cautions carefully.
- Some CD-Rs or CD-RWs may not be played back on this unit because of their disc characteristics, damage or stain on them, or the player’s lens is dirty.
- CD-RWs may require a longer readout time. This is caused by the fact that the reflectance of CD-RWs is lower than for regular CDs.

Loading CDs

On the unit ONLY:

- 1 Press  for the disc tray (CD1, CD2, and CD3) you want to load a CD onto.**

The unit automatically turns on and the disc tray comes out.

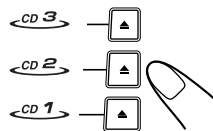

- 2 Place a disc correctly on the circle of the disc tray, with its label side up.**

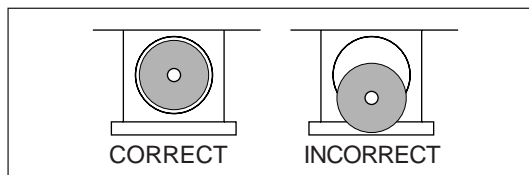

- When using a CD single (8 cm), place it on the inner circle of the disc tray.

- 3 Press the same  you have pressed in step 1.**

The disc tray closes.

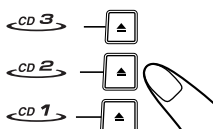

- 4 Repeat steps 1 to 3 to place other CDs.**



When loading more than one CD continuously

When you press  for the next tray you want to place another CD onto, the first disc tray automatically closes and then the next tray comes out.

About the CD ready lamps

Each CD ready lamp corresponds to the disc tray of the same number.

• When and why they light up?

- When you turn on the unit for the first time after plugging into a wall outlet, all CD ready lamps (CD1 READY, CD2 READY, and CD3 READY) lights up. From the next time on, CD ready lamp(s) light(s) up according to the previous condition.
- Each time you press the CD eject buttons— (CD1, CD2, and CD3), the corresponding CD ready lamp lights up.

• When and why they go off?

Only when the unit detects there is no CD loaded on the tray, the corresponding CD ready lamp goes off. (“NO DISC 1,” “NO DISC 2,” or “NO DISC 3” appears on the display.)

• When and why they flash?

The corresponding CD ready lamp flashes during playback and pause.

Playing Back the Entire Discs—Continuous Play

You can play CDs continuously.

1 Load CDs.

2 Press one of the disc number (CD1, CD2, and CD3) buttons for the disc you want to play.

The unit starts searching for the CD and CD play starts from the first track of the selected disc.

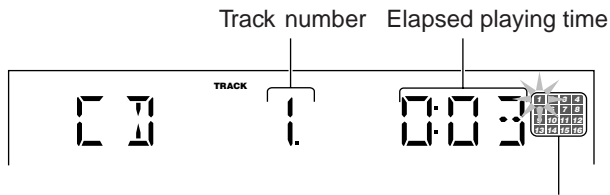
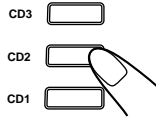

Tracks of the currently playing disc (Track numbers exceeding 16 are not displayed.)

- Pressing CD ►/|| instead of the disc number buttons starts playing back the currently selected CD.
- If no CD is placed on the selected disc tray, “NO DISC 1,” “NO DISC 2,” or “NO DISC 3” appears on the display. Then, the unit continues searching for a CD from the next disc tray.

To stop playing, press ■.

To remove the disc, press ▲ for the corresponding disc tray.



CD playback sequence

When 3 CDs* are loaded on the disc trays, they are played in one of the following sequences.

- When CD1 is pressed: CD1 ⇒ CD2 ⇒ CD3 (then stops)
- When CD2 is pressed: CD2 ⇒ CD3 ⇒ CD1 (then stops)
- When CD3 is pressed: CD3 ⇒ CD1 ⇒ CD2 (then stops)

* When only 2 CDs are loaded, they are played in the same order, but the disc tray without a CD is skipped.

Basic CD Operations

While playing a CD, you can do the following operations.

To exchange CDs during playback of another

Press ▲ corresponding to a CD, not playing or selected currently, to eject and exchange the CD.

If you exchange CDs during play, the current play will not stop until all CDs you have exchanged are played.

To stop play for a moment

Press CD ►/||.

While pausing, the elapsed playing time flashes on the display.

To resume playing, press CD ►/|| again.



To go to another track

Turn ◀◀◀ / ▶▶▶ before or during playback (or press ◀◀◀ (◀◀◀) / ▶▶▶ (▶▶▶) on the remote control).

- ◀◀◀ (or ◀◀◀ (◀◀◀)): Goes back to the beginning of the current or previous tracks.
- ▶▶▶ (or ▶▶▶ (▶▶▶)): Skips to the beginning of the next or succeeding tracks.

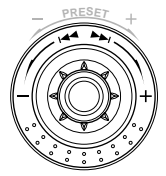

To locate a particular point in a track

During play, press and hold ◀◀ or ▶▶ (or ◀◀◀ (◀◀◀) / ▶▶▶ (▶▶▶) on the remote control).

- ◀◀ (or ◀◀◀ (◀◀◀)): Fast reverses the disc.
- ▶▶ (or ▶▶▶ (▶▶▶)): Fast forwards the disc.

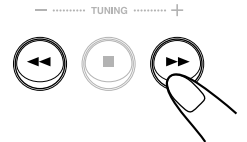

To go to another track directly using the number buttons

On the remote control ONLY:

Pressing the number button(s) before or during play allows you to start playing the track number you want.

Ex.: For track number 5, press 5.

For track number 15, press +10, then 5.

For track number 20, press +10, then 10.

For track number 32, press +10, +10, +10, then 2.

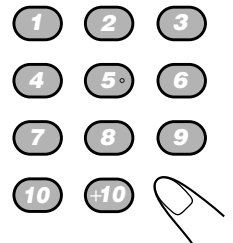

Programming the Playing Order of the Tracks —Program Play

You can arrange the playing order of the tracks before you start playing. **You can program up to 32 tracks.**

- To use Repeat Play (see page 20) for Program Play, press REPEAT after starting Program Play. Only REPEAT 1 and REPEAT ALL can be selected for Program Play.
- There is a time limit in doing the following steps. If the setting is canceled before you finish, start from step 2 again.

1 Load CDs.

- If the current playing source is not the CD player, press CD ►/II, then ■ before going to the next step.

2 Activating the Program Play mode.

On the unit:

Press CD PLAY MODE repeatedly until “CD PROGRAM” appears on the display.



- Each time you press the button, the play mode changes as follows:

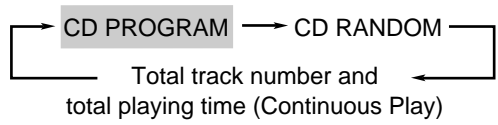

On the remote control:

Press PROGRAM so that “CD PROGRAM” appears on the display.

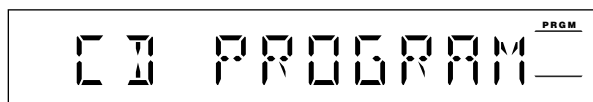
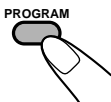

- If a program has been stored in memory, the program is called up.
- The PRGM (program) indicator also lights up on the display.

3 Press one of the disc number (CD1, CD2, and CD3) buttons to select the disc you want to play.

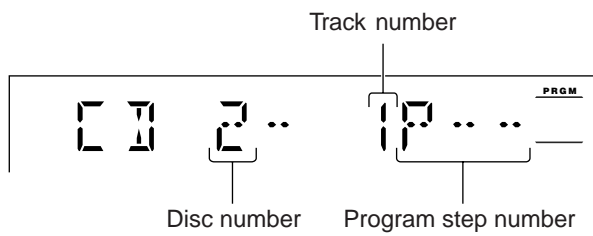
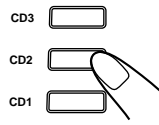

4 Select a track from the selected CD in the above step.

On the unit:

Turn |◀◀ / ▶▶| to select the track number and press SET/DISPLAY.

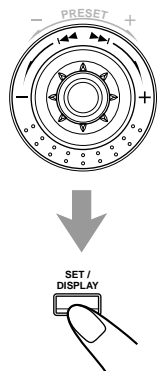

On the remote control:

Press the number buttons.

- For how to use the number buttons, see “To go to another track directly using the number buttons” on page 17.

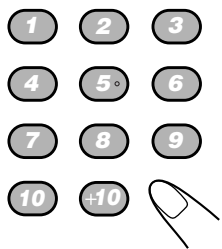

5 Program other tracks you want.

- To program tracks from the same disc, repeat step 4.
- To program tracks from a different disc, repeat steps 3 and 4.

6 Press CD ►/II.

The tracks are played in the order you have programmed.

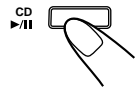

To stop playing, press ■.

To exit from Program Play mode, press CD PLAY MODE repeatedly (or PROGRAM on the remote control) until the PRGM (program) indicator goes off. The program you have made is stored in memory.



- **If you try to program a 33rd track**
“CD FULL” will appear on the display.
- **If your entry is ignored**
You have tried to program a track from an empty tray, or a track number that does not exist on the CD (for example, selecting track 14 on a CD that only has 12 tracks). Such entries are ignored.

To check the program contents

On the remote control ONLY:

Before playing, you can check the program contents by pressing

◀◀◀ (◀◀) or ▶▶▶ (▶▶).

- ◀◀◀ (◀◀) : Shows the programmed tracks in the reverse order.
- ▶▶▶ (▶▶) : Shows them in the programmed order.

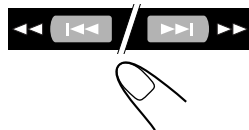

To modify the program

Before or after playing, you can erase the last programmed tracks by pressing CANCEL/DEMO (or press PROGRAM CANCEL on the remote control).

- Each time you press the button, the last programmed track is erased from the program.

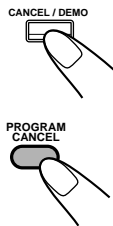

To add tracks in the program before playing, simply select the track numbers you want to add by following step 4 of the programming procedure on page 18. If you want to add tracks from another disc, follow steps 3 and 4.

To erase the entire program before or after playing, press and hold ■ until “CD PROGRAM” appears on the display.

- The program you have made will be erased,
 - when you unplug the AC power cord, and
 - when a power failure occurs.

Playing at Random—Random Play

The tracks of all loaded CDs will be played at random.

- To use Repeat Play (see page 20) for Random Play, press REPEAT after starting Random Play. Only REPEAT 1 and REPEAT ALL can be selected for Random Play.

1 Load CDs.

- If the current playing source is not the CD player, press CD ▶/■, then ■ before going to the next step.

2 Activating the Random Play mode.

On the unit:

Press CD PLAY MODE repeatedly until “CD RANDOM” appears on the display.

- Each time you press the button, the play mode changes as follows:

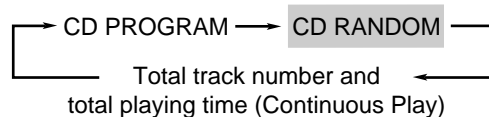

On the remote control:

Press RANDOM so that “CD RANDOM” appears on the display.

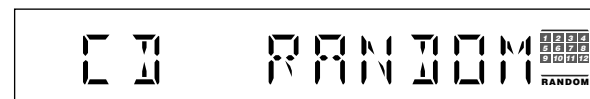

- The RANDOM indicator also lights up on the display.

3 Press CD ▶/■.

The tracks are randomly played.

Random Play ends when all the tracks are played once.



To skip the currently playing track, turn ◀◀ / ▶▶ to the right (or press ▶▶ (▶▶) on the remote control).



If you turn ◀◀ / ▶▶ to the left (or press ◀◀ (◀◀) on the remote control)

- You cannot go back to the previous tracks during Random Play.
- You can only restart the current playing track.

To stop playing, press ■.

- Random play also stops when one of the disc trays is opened.

To exit from Random Play mode, press CD PLAY MODE (or RANDOM on the remote control) repeatedly, until the RANDOM indicator goes off after playback stops.



Repeating Tracks or CDs—Repeat Play

You can have all the CDs, the program or the individual track currently playing to repeat as many times as you like.

To repeat playing, press REPEAT during or before play.

- Each time you press the button, Repeat Play mode changes as follows:

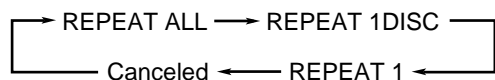

The Repeat Play mode indicator lights up on the display.

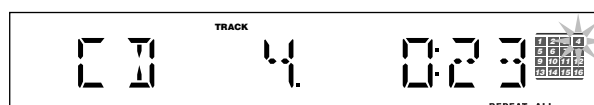

REPEAT ALL: Repeats all the tracks on all the CDs (continuously or at random), or all the tracks in the program.

REPEAT 1DISC: Repeats all the tracks on one CD.

REPEAT 1: Repeats one track on one CD.

To cancel Repeat Play, press REPEAT repeatedly until the Repeat Play mode indicators get off from the display.



“REPEAT 1DISC” is not selected for Program Play and Random Play

It is canceled when you select Program Play or Random Play.

Prohibiting Disc Ejection—Tray Lock

You can prohibit CD ejection from the unit and lock CDs.

- This operation is possible only when the source is the CD player.

On the unit ONLY:

To prohibit disc ejection, press ▲ for any disc tray while holding down ■. (If there is any disc tray opened, close it first.)

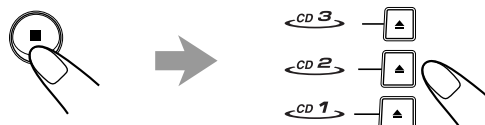

“LOCKED” appears for a while on the display, and the loaded CDs are locked.

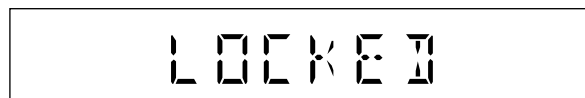

To cancel the prohibition and unlock the CDs, press ▲ for any disc tray while holding down ■.

“UNLOCKED” appears for a while on the display, and the loaded CDs are unlocked.

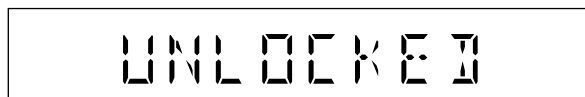

If you try to eject CDs while Tray Lock is in used “LOCKED” appears to inform you that the disc tray is locked.

Playing Back Tapes



You can play back type I tapes without changing any settings.

Playing Back a Tape

1 Press **EJECT** for the cassette deck.

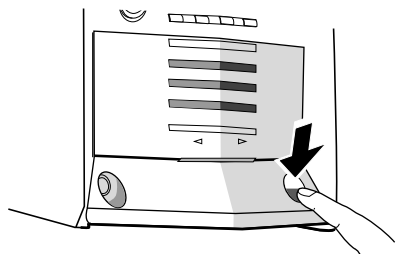

2 Insert a cassette in with the exposed part of the tape down.

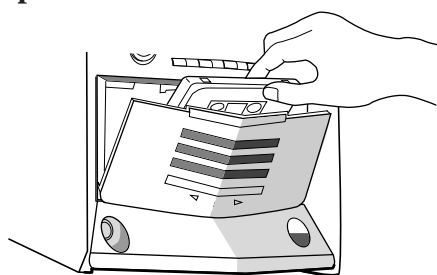

3 Close the cassette holder gently.

4 Press **TAPE** .

The tape play starts and the tape direction indicator (or) starts flashing slowly to indicate the tape running direction.

- Each time you press the button, the tape direction changes and “REVERSE” appears for a while on the display.
 - ▶ : plays the front side.
 - ◀ : plays the reverse side.
- If no cassette is inserted, “NO TAPE” appears on the display.

When the tape plays to the end, the deck automatically stops if the Reverse Mode is off. (See “To play both sides repeatedly—Reverse Mode.”)

To stop playing, press .

To fast-wind to the left or to the right, press (or /) on the remote control) while the tape is not running.

The tape direction indicator (or) starts flashing quickly on the display.

To remove the cassette, press **EJECT** to open the cassette holder.



The use of the C-120 or thinner tape is not recommended, since characteristic deterioration may occur and this tape easily jams in the pinch-rollers and the capstans.

To play both sides repeatedly—Reverse Mode

When using Reverse Mode, the tape automatically reverses at the end of a side and the unit starts playing for the other side of the tape, and repeats the same process.

On the unit ONLY:

To use Reverse Mode, press REVERSE MODE so that the Reverse Mode indicator on the display lights up like—.

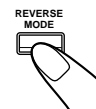

To cancel Reverse Mode, press the button again so that the Reverse Mode indicator on the display lights up like—.

Locating the Beginning of a Song—Music Scan

You can use Music Scan to locate the beginning of a song. Music Scan searches for blank portions that usually separate recorded songs, then plays the next song.

To find the beginning of the current song

During play, press (or /) on the remote control in the **opposite direction** to the tape play.

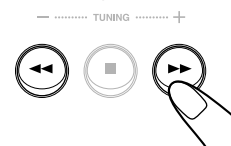

The tape direction indicator of the opposite direction to the tape play starts flashing intermittently.

Searching stops automatically at the beginning of the current song, and the current song starts automatically.

To find the beginning of the next song

During play, press (or /) on the remote control in the **same direction** as the tape play.

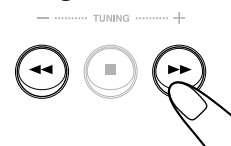

The tape direction indicator of the same direction as the tape play starts flashing intermittently.

Searching stops automatically at the beginning of the next song, and the next song starts automatically.



Music Scan works by detecting a 4-second long blank between each song, so it will not work well in the following cases

- No blank at the beginning of a song.
- Noise (often caused by much use or poor quality dubbing) which fills the blank.
- Long, very soft passages or pauses in a song.

IMPORTANT:

- It should be noted that it may be unlawful to re-record pre-recorded tapes, records, or discs without the consent of the owner of copyright in the sound or video recording, broadcast or cable programme and in any literary, dramatic, musical, or artistic embodied therein.
- The recording level is automatically set correctly, so it is not affected by the VOLUME, the SUBWOOFER LEVEL, and the SOUND MODE controls. Thus, during recording you can adjust the sound you are actually listening to without affecting the recording level.
- If there are excessive noise or static in the recording you have made, the unit may be too close to a TV. Increase the distance between the TV and the unit.
- You can use type I tape for recording.

To protect your recording

Cassettes have two small tabs on the back to protect from unexpected erasure or re-recording.

To protect your recording, remove these tabs.

To re-record on a protected tape, cover the holes with adhesive tape.

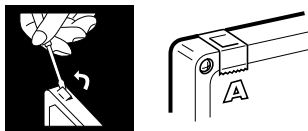

To keep the best recording and playback sound quality

If the heads, capstans, and pinch rollers of the cassette deck become dirty, the following will occur:

- Impaired sound quality
- Discontinuous sound
- Fading
- Incomplete erasure
- Difficulty in recording

To clean the heads, capstans, and pinch rollers

Use a cotton swab moistened with alcohol.

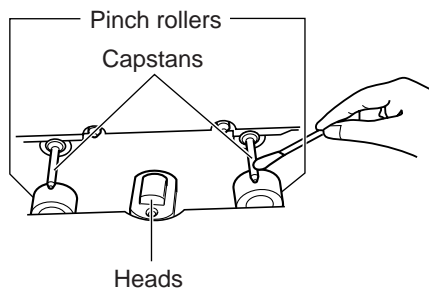





To demagnetize the heads

Turn off the unit, and use a head demagnetizer (available at electronics and audio shops).

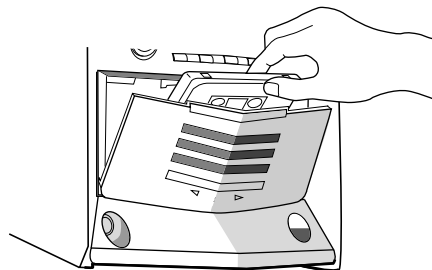
Recording on a Tape

- 1 Press  EJECT to insert a recordable cassette with the exposed part of the tape down.



- 2 Close the cassette holder gently.
 - If you want to record on both sides of a tape, see “To record on both sides—Reverse Mode.”
- 3 Check the tape direction of the cassette deck.
 - If the tape direction is not correct, press TAPE   twice then  to change the tape direction.
- 4 Start playing the source—FM, AM, CD player, or auxiliary equipment connected to AUX jacks.
 - When the source is CD, you can also use CD Direct Recording—(see page 23), and Auto Edit Recording—(see page 24).



- 5 Start recording.

On the unit:

Press REC START/STOP.

On the remote control:

Press and hold REC START/STOP for more than 1 second.

The REC (recording) lamp flashes when recording starts and the tape direction indicator ( or ) starts flashing slowly.

- If no cassette is inserted, “NO TAPE” appears on the display. If a protected tape is inserted, “NO REC” appears on the display.





To stop recording immediately, press REC START/STOP or  (or press and hold REC START/STOP on the remote control for more than 1 second).

To remove the cassette, press  EJECT to open the cassette holder.

To record on both sides—Reverse Mode

On the unit ONLY:

Press REVERSE MODE so that the Reverse Mode indicator on the display lights up like—.

- When using the Reverse Mode for recording, start recording in the forward () direction first. Otherwise, recording will stop when recording is done only on one side (reverse) of the tape.

To cancel Reverse Mode, press the button again so that the Reverse Mode indicator on the display lights up like—.

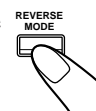

CD Synchronized Recording

By using CD Synchronized Recording methods, you can start and stop a CD play and tape recording at the same time.

CD Synchronized Recording consists of the followings:

- CD Direct Recording
- Auto Edit Recording

■ CD Direct Recording

Everything on the CD goes onto the tape in the order it is on the CD, or according to the order you have made for Program Play.

On the unit ONLY:

- 1 Press ▲ EJECT to insert a recordable cassette in with the expose part of the tape down.**



- 2 Load CDs.**

- 3 Press one of the disc number (CD1, CD2, and CD3) buttons to select the disc, then ■.**

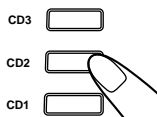

- If you want to make a program, perform steps **2** to **5** on page 18. After making a program, go to the next step.

- 4 Press CD REC START.**

“CD REC” appears on the display and the REC (recording) lamp flashes when recording starts.

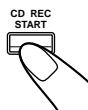

The cassette deck starts recording while the CD player starts playing.

When the recording is done, “CD REC FINISHED” scroll through the display, and the REC (recording) lamp goes off. Both the cassette deck and the CD player stop automatically.

To stop recording, press ■ to create a 4-second blank portion on the recording tape. (Remember a 4-second blank is important when using Music Scan—see page 21.)



To record on both sides—Reverse Mode

On the unit ONLY:

Press REVERSE MODE so that the Reverse Mode indicator on the display lights up like—(◀▶).

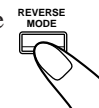

- When using the Reverse Mode for CD Direct Recording, start recording in the forward (▶) direction first. When the tape reaches its end while recording a song in the forward direction (▶), the last song will be re-recorded at the beginning of the reverse side (◀). If you start recording on the reverse side (◀), recording will stop when recording is done only on one side (reverse) of the tape.

To cancel Reverse Mode, press the button again so that the Reverse Mode indicator on the display lights up like—◻.



■ Auto Edit Recording

By using Auto Edit Recording, you can record the CD tracks to fit the tape. Auto Edit Recording makes a program by selecting the CD tracks in numerical order. However, to prevent the end of the last track on the front side from being cut off, the last track is selected so to fit the remaining tape length.

On the unit ONLY:

1 Load CDs.

- If the current playing source is not the CD player, press CD ►/■, then ■ before going to the next step.

2 Press EDIT.

MISC ..



3 Press one of the disc number (CD1, CD2, and CD3) buttons to select the disc you want to record from.

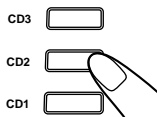

TAPE C ..



TAPE C60

The optimum tape length for the disc appears.

To change the tape length manually

If the tape length selected is not satisfactory, you can change the tape length by turning ◀◀ / ▶▶ on the unit. You can select the tape length among the following —40, 46, 50, 54, 60, 64, 70, 74, 80, 84, and 90.

4 Press SET/DISPLAY.

- Each time you press the button, the tracks to be recorded on the front side (“SIDE-A”) and on the reverse side (“SIDE-B”) appears on the display alternately.

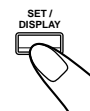

Tracks to be recorded on the reverse side (SIDE-B) appear.

SIDE .. B

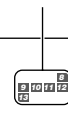

5 Insert a recordable cassette of appropriate length into the cassette deck.

6 Press REVERSE MODE so that the Reverse Mode indicator lights up like (Z).

- Without turning on the Reverse Mode, recording will stop when the front side of the tape is recorded.

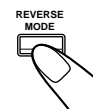

7 Press CD REC START.

“CD REC” appears, then “TAPE SIDE-A STAND-BY” scroll through the display, and the REC (recording) lamp flashes.

The cassette deck starts recording. About 10 seconds later, the CD player starts playing.

When the recording is done, “CD REC FINISHED” scroll through the display and the REC (recording) lamp goes off. Both the cassette deck and CD player stop automatically.

- If a tape has not been rewound, the cassette deck will rewind the tape before it starts recording.
- A 10-second blank portion is automatically created at the beginning of each side of the tape.

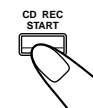

To stop during Auto Edit Recording

Press REC START/STOP or ■ to create a 4-second blank portion on the recording tape. (Remember a 4-second blank is important when using Music Scan—see page 21.)

To cancel Auto Edit Recording

Press CANCEL/DEMO before or after recording.

Using the Timers

There are three timers available—DAILY (Daily Timer), REC (Recording Timer), and SLEEP (Sleep Timer).

Before using the timers, you need to set the clock built in the unit. (See page 10.)

Using Daily Timer

With Daily Timer, you can be awakened with your favorite music or radio program.

You can set the timer whether the unit is on or off; however, if Ecology Mode is activated, you cannot set the clock while the unit is off.

How Daily Timer actually works

The unit automatically turns on, sets the volume level to the preset level, and starts playing the specified source when the on-time comes (“DAILY” and the DAILY (Daily Timer) indicator flash just before the on-time, and the DAILY (Daily Timer) indicator continues flashing while the timer is operating). Then, when the off-time comes (“DAILY OFF” flashes just before the off-time), the unit automatically turns off (on standby).

The Daily Timer works everyday automatically. If you do not want to use the Daily Timer, turn off the Daily timer. (See “To turn on or off Daily Timer after its setting is done” on page 26.) The timer setting remains in memory until you change it.

- There is a time limit in doing the following steps. If the setting is canceled before you finish, start from step 1 again.
- To correct a mis-entry while setting the timer, press CANCEL/DEMO.

Before you start...

- *When using a CD as the source to play—*
 - Make sure there is a CD on the selected disc number tray.
- *When using a tape as the source to play—*
 - Make sure that a tape is in the cassette deck.
 - Make sure that the tape direction is correct.
- *When using the external component as the source to play—*
 - Set the timer equipped on the external component at the same time.

On the unit ONLY:

- 1 Press **CLOCK/TIMER** repeatedly until “DAILY” appears on the display.

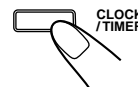

• (Timer) indicator lights up and the DAILY (Daily Timer) indicator also starts flashing on the display.



- Each time you press the button, the timer setting modes change as follows:

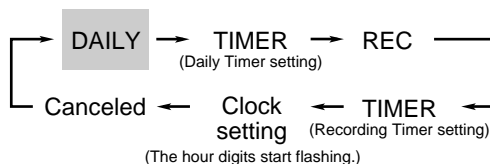

- 2 Press **CLOCK/TIMER** again.

“TIMER” appears for 2 seconds, then the unit enters on-time setting mode.

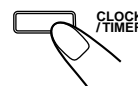

- 3 Set the on-time you want the unit to turn on at.

- 1) Turn **◀◀ / ▶▶** to set the hour, then press **SET/DISPLAY**.
- 2) Turn **◀◀ / ▶▶** to set the minute, then press **SET/DISPLAY**. “SET” appears for 1 second, then the unit enters off-time setting mode.

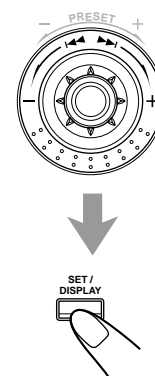

4 Set the off-time you want the unit to turn off (on standby) at.

- 1) Turn **◀◀ / ▶▶** to set the hour, then press SET/DISPLAY.
- 2) Turn **◀◀ / ▶▶** to set the minute, then press SET/DISPLAY.
 “SET” appears for 1 second, then the unit enters source selecting mode.

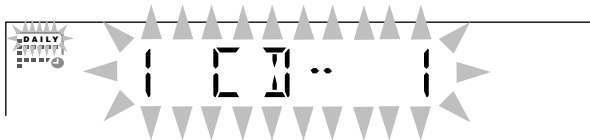

5 Turn **◀◀ / ▶▶ to select the source to play, then press SET/DISPLAY.**

“SET” appears for 1 second.
 • The source changes as follows:



- TUNER FM: tunes in to a specified preset FM station. → **Go to step 6.**
- TUNER AM: tunes in to a specified preset AM station. → **Go to step 6.**
- 1 CD-- 1: plays a disc from a specified track of a specified disc. → **Go to step 6.**
- TAPE: plays a tape in the cassette deck. → **Go to step 7.**
- AUX IN: plays an external source. → **Go to step 7.**

6 When selecting “TUNER FM” or “TUNER AM”

Turn **◀◀ / ▶▶** to select the preset station number, then press SET/DISPLAY.
 The unit enters volume setting mode.

When selecting “1 CD-- 1”

- 1) Turn **◀◀ / ▶▶** to select the disc number, then press SET/DISPLAY.
 “SET” appears for 1 second.
- 2) Turn **◀◀ / ▶▶** to set the track number, then press SET/DISPLAY.
 “SET” appears for 1 second, then the unit enters volume setting mode.

7 Turn **◀◀ / ▶▶ to set the volume level.**

• The volume level changes as follows:

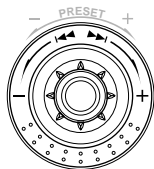
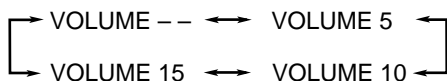

- If you select “VOLUME --,” the volume is set to the last level when the unit has been turned off.

8 Press SET/DISPLAY to complete the Daily Timer setting.

The DAILY (Daily Timer) indicator stops flashing and remains lit. “OK ✓” appears on the display for 2 seconds.
 The settings you have done are shown on the display in sequence for your confirmation.

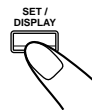

9 Press **⏻/| to turn off the unit (on standby) if you have set the Daily Timer with the unit turned on.**

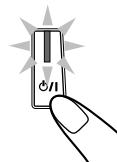

- If the unit is turned on when the on-time comes Daily Timer does not work.
- Even if you unplug the AC power cord or if a power failure occurs
 Once you set the timer, the timer setting may remain stored in memory in a few days. In this case, check whether the timer setting still remains or not.

To turn on or off Daily Timer after its setting is done

1 Press CLOCK/TIMER repeatedly until “DAILY” appears on the display.

(Timer) indicator lights up and the DAILY (Daily Timer) indicator starts flashing on the display.

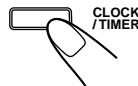

2 To turn off the Daily Timer, press CANCEL/DEMO.

The DAILY (Daily Timer) indicator goes off from the display (“DAILY OFF” appears for a while).
 The Daily Timer is canceled, but the setting for the Daily Timer remains in memory.

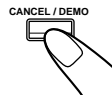

Or

To turn on the Daily Timer, press SET/DISPLAY.

“OK ✓” appears on the display for 2 seconds.
 The settings you have done are shown on the display in sequence for your confirmation.

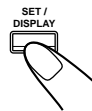

Using Recording Timer

With Recording Timer, you can make a tape of a radio broadcast automatically.

You can set the timer whether the unit is on or off; however, if Ecology Mode is activated, you cannot set the clock while the unit is off.

How Recording Timer actually works

The unit automatically turns on, tunes in to the specified station, sets the volume level to “VOLUME MIN,” and starts recording when the on-time comes (“REC” and the REC (Recording Timer) indicator flash just before the on-time, and the REC (Recording Timer) indicator continues flashing while the timer is operating). Then, when the off-time comes (“REC OFF” flashes just before the off-time), the unit automatically turns off (on standby).

The timer setting remains in memory until you change it.

- There is a time limit in doing the following steps. If the setting is canceled before you finish, start from step **2** again.
- To correct a mis-entry while setting the timer, press CANCEL/DEMO.

On the unit ONLY:

1 Insert a recordable cassette in with the expose part of the tape down.

2 Press CLOCK/TIMER repeatedly until “REC” appears on the display.

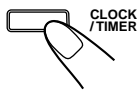

- (Timer) indicator lights up and the REC (Recording Timer) indicator also starts flashing on the display.



- Each time you press the button, the timer setting modes change as follows:

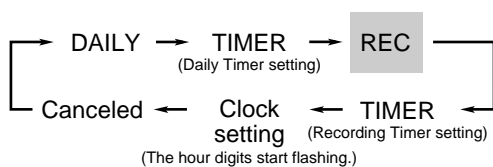

3 Press CLOCK/TIMER again.

“TIMER” appears for 2 seconds, then the unit enters on-time setting mode.

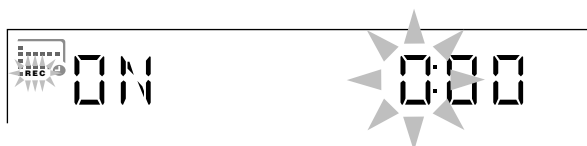

4 Set the on-time you want the unit to turn on at.

- 1) Turn ◀◀ / ▶▶ to set the hour, then press SET/DISPLAY.
- 2) Turn ◀◀ / ▶▶ to set the minute, then press SET/DISPLAY. “SET” appears for 1 second, then the unit enters off-time setting mode.

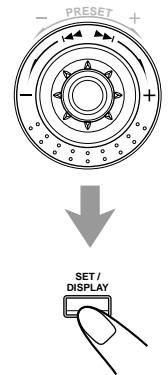

5 Set the off-time you want the unit to turn off (on standby) at.

- 1) Turn ◀◀ / ▶▶ to set the hour, then press SET/DISPLAY.
- 2) Turn ◀◀ / ▶▶ to set the minute, then press SET/DISPLAY. “SET” appears for 1 second, then the unit enters preset station selecting mode.

6 Select the preset station.

- 1) Turn ◀◀ / ▶▶ to select the band (“TUNER FM” or “TUNER AM”), then press SET/DISPLAY. “SET” appears for 1 second.
- 2) Turn ◀◀ / ▶▶ to select a preset channel number, then press SET/DISPLAY. The REC (Recording Timer) indicator stops flashing and remains lit. “OK ✓” appears on the display for 2 seconds. The settings you have done are shown on the display in sequence for your confirmation.

7 Press ⏻/I to turn off the unit (on standby) if necessary.

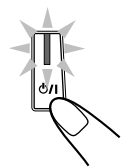

- **If you want to listen to another source while recording**
Press REC START/STOP or ■ to stop recording. Without stopping it, you cannot change the source.
- **Even if you unplug the AC power cord or if a power failure occurs**
Once you set the timer, the timer setting may remain stored in memory in a few days. In this case, check whether the timer setting still remains or not.



To turn on or off Recording Timer after its setting is done

1 Press CLOCK/TIMER repeatedly until “REC” appears on the display.

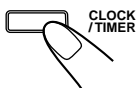

• (Timer) indicator lights up and the REC (Recording Timer) indicator starts flashing on the display.

2 To turn off the Recording Timer, press CANCEL/DEMO.

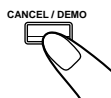

The REC (Recording Timer) indicator goes off from the display (“REC OFF” appears on the display for 2 seconds).

The Recording Timer is canceled, but the setting for the Recording Timer remains in memory.

Or

To turn on the Recording Timer, press SET/DISPLAY.

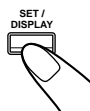

“OK ✓” appears on the display for 2 seconds.

The settings you have done are shown on the display in sequence for your confirmation.

Using Sleep Timer

With Sleep Timer, you can fall asleep to music. You can set Sleep Timer only while the unit is turned on.

How Sleep Timer actually works

The unit automatically turns off after the specified time length passes.

On the remote control ONLY:

1 Press SLEEP.

The time length until the shut-off time appears and the SLEEP indicator starts flashing on the display.



• Each time you press the button, the time length changes as follows:

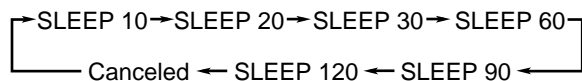

2 Wait for about 5 seconds after specifying the time length.

The SLEEP indicator stops flashing and remains lit.

To check the remaining time until the shut-off time, press SLEEP once so that the remaining time (minute) until the shut-off time appears for about 5 seconds.

To change the shut-off time, press SLEEP repeatedly until the desired time length appears on the display.

To cancel the setting, press SLEEP repeatedly so that the SLEEP indicator goes off.

• Sleep Timer is also canceled when you turn off the unit.

Timer Priority

Since each timer can be set separately, you may wonder what happens if the setting for these timers overlaps.

Below are some examples.

Recording Timer has priority over Daily Timer and Sleep Timer.

• If Daily Timer is set to come on while Recording Timer is operating, Daily Timer will not come on at all.

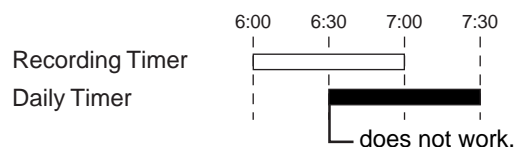

• If Recording Timer is set to come on while Sleep Timer is operating, Sleep Timer will be canceled.

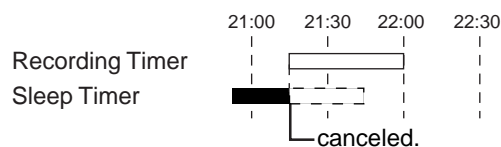

Additional Information



Description of the PTY codes:

NEWS:	News.
AFFAIRS:	Topical program expanding or enlarging upon the news—debate, or analysis.
INFO:	Program the purpose of which is to impart advice in the widest sense.
SPORT:	Program concerned with any aspect of sports.
EDUCATE:	Educational programs.
DRAMA:	All radio plays and serials.
CULTURE:	Programs concerning any aspect of national or regional culture, including language, theatre, etc.
SCIENCE:	Programs about natural sciences and technology.
VARIED:	Used for mainly speech-based programs like quizzes, panel games and personality interviews.
POP M:	Commercial music of current popular appeal.
ROCK M:	Rock music.
EASY M:	Current contemporary music considered to be “easy-listening.”
LIGHT M:	Instrumental music, and vocal or choral works.
CLASSICS:	Performances of major orchestral works, symphonies, chamber music, etc.
OTHER M:	Music not fitting into any of the other categories.
WEATHER:	Weather reports and forecasts.

FINANCE:	Stock Market reports, commerce, trading etc.
CHILDREN:	Programs targeted at a young audience.
SOCIAL:	Programs about sociology, history, geography, psychology and society.
RELIGION:	Religious programs.
PHONE IN:	Involving members of the public expressing their views either by phone or at a public forum.
TRAVEL:	Travel information.
LEISURE:	Programs about recreational activities.
JAZZ:	Jazz music.
COUNTRY:	Songs which originate from, or continue the musical tradition of the American Southern States.
NATION M:	Current popular music of the nation or region in that country’s language.
OLDIES:	Music from the so-called “golden age” of popular music.
FOLK M:	Music which has its roots in the musical culture of a particular nation.
DOCUMENT:	Program concerning factual matters, presented in an investigative style.
TEST:	Broadcasts for testing emergency broadcast equipment or receiver.
ALARM:	Emergency announcement.

Classification of the PTY codes for some FM stations may be different from the above list.

Maintenance



To get the best performance of the unit, keep your discs, tapes, and mechanism clean.

General Notes

In general, you will have the best performance by keeping your discs and the mechanism clean.

- Store discs in their cases, and keep them in cabinets or on shelves.
- Keep the unit's disc trays closed when not in use.

Handling discs



- Remove the disc from its case by holding it at the edge while pressing the center hole lightly.
- Do not touch the shiny surface of the disc, or bend the disc.
- Put the disc back in its case after use to prevent warping.

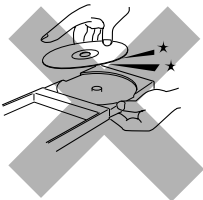

- Be careful not to scratch the surface of the disc when placing it back in its case.
- Avoid exposure to direct sunlight, temperature extremes, and moisture.



To clean the disc
Wipe the disc with a soft cloth in a straight line from center to edge.



DO NOT use any solvent—such as conventional record cleaner, spray, thinner, or benzene—to clean the disc.

Handling cassette tapes

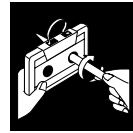

- If the tape is loose in its cassette, take up the slack by inserting a pencil in one of the reels and rotating.
- If the tape is loose, it may get stretched, cut, or caught in the cassette.

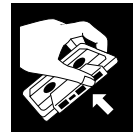

- Be careful not to touch the tape surface.



- Avoid the following places to store the tape:
 - In dusty places
 - In direct sunlight or heat
 - In moist areas
 - Near a magnet

Cleaning the unit

Stains on the unit

Should be wiped off with a soft cloth. If the unit is heavily stained, wipe it with a cloth soaked in water diluted neutral detergent and wrung well, then wipe clean with a dry cloth.

Since the unit may deteriorate in quality, become damaged or get its paint peeled off, be careful about the followings.

- DO NOT wipe it with a hard cloth.
- DO NOT wipe it strong.
- DO NOT wipe it with thinner or benzene.
- DO NOT apply any volatile substance such as insecticides to it.
- DO NOT allow any rubber or plastic to remain in contact with it for a long time.

Troubleshooting



If you are having a problem with your unit, check this list for a possible solution before calling for service. If you cannot solve the problem from the hints given here, or the unit has been physically damaged, call a qualified person, such as your dealer, for service.

	Symptom	Cause	Action
GENERAL	Unable to cancel the demonstration.	The button other than CANCEL/DEMO is pressed to cancel the display demonstration temporarily.	Press CANCEL/DEMO on the unit. (See page 9.)
	No sound is heard.	Connections are incorrect or loose.	Check all connections and make corrections. (See pages 7 to 9.)
	Operations are disabled.	The built-in microprocessor may malfunction due to external electrical interference.	Unplug the AC power cord and then plug it back in.
	Unable to operate the unit from the remote control.	<ul style="list-style-type: none"> The path between the remote control and the remote sensor on the unit is blocked. The batteries are exhausted. 	<ul style="list-style-type: none"> Remove the obstruction. Replace the batteries.
TUNER	Hard to listen to broadcasts because of noise.	<ul style="list-style-type: none"> Antennas are disconnected. The AM loop antenna is too close to the unit. The FM antenna is not properly extended and positioned. 	<ul style="list-style-type: none"> Reconnect the antennas correctly and securely. Change the position and direction of the AM loop antenna. Extend the FM antenna at the best position.
CD	The disc sound is discontinuous.	The disc is scratched or dirty.	Clean or replace the disc. (See page 30.)
	The disc tray does not open or close.	<ul style="list-style-type: none"> The AC power cord is not plugged in. Trays are locked. 	<ul style="list-style-type: none"> Plug the AC power cord. Unlock the trays. (See page 20.)
	The disc does not play.	The disc is placed upside down.	Place the disc with the label side up.
TAPE	The cassette holders cannot be opened.	Power supply from the AC power cord has been cut off while the tape was running.	Turn on the unit.
REC	Impossible to record.	Small tabs on the back of the cassette are removed.	Cover the holes with adhesive tape. (See page 22.)

Specifications

Design and specifications are subject to change without notice.

CA-HXZ1R

Amplifier section

Output Power (IEC 268-3/DIN)

SUBWOOFERS: 86 W per channel, min. RMS, both channels driven into 6 Ω at 63 Hz with no more than 0.9% total harmonic distortion.

MAIN SPEAKERS: 21 W per channel, min. RMS, both channels driven into 6 Ω at 1 kHz with no more than 0.9% total harmonic distortion.

Audio input sensitivity/Impedance

(Measured at 1 kHz, with tape recording signal 300 mV)

AUX: 390 mV/50 k Ω

Digital output: CD OPTICAL DIGITAL OUTPUT

Signal wave length: 660 nm

Output level: -15 dBm to -12 dBm

Speakers/Impedance:

SUBWOOFERS: 6 Ω – 16 Ω

MAIN SPEAKERS: 6 Ω – 16 Ω

Tuner

FM tuning range: 87.50 MHz – 108.00 MHz

AM tuning range: MW: 522 kHz – 1 629 kHz

LW: 144 kHz – 288 kHz

CD player

CD capacity: 3 CDs

Dynamic range: 85 dB

Signal-to-noise ratio: 90 dB

Wow and flutter: Immeasurable

Cassette deck

Frequency response

Normal (type I): 50 Hz – 14 000 Hz

Wow and flutter: 0.15% (WRMS)

General

Power requirement: AC 230 V \sim , 50 Hz

Power consumption: 160 W (at operation)

21 W (on standby with Ecology Mode off)

1.2 W (on standby with Ecology Mode on)

Dimensions (approx.): 205 mm \times 370 mm \times 370 mm (W/H/D)

Mass (approx.): 10.0 kg

Supplied accessories

See page 7.

CA-HXZ1

Amplifier section

Output Power (IEC 268-3)

SUBWOOFERS: 86 W per channel, min. RMS, both channels driven into 6 Ω at 63 Hz with no more than 0.9% total harmonic distortion.

MAIN SPEAKERS: 21 W per channel, min. RMS, both channels driven into 6 Ω at 1 kHz with no more than 0.9% total harmonic distortion.

Audio input sensitivity/Impedance

(Measured at 1 kHz, with tape recording signal 300 mV)

AUX: 390 mV/50 k Ω

Digital output: CD OPTICAL DIGITAL OUTPUT

Signal wave length: 660 nm

Output level: -15 dBm to -12 dBm

Speakers/Impedance:

SUBWOOFERS: 6 Ω – 16 Ω

MAIN SPEAKERS: 6 Ω – 16 Ω

Tuner

FM tuning range: 87.50 MHz – 108.00 MHz

AM tuning range: 522 kHz – 1 629 kHz

CD player

CD capacity: 3 CDs

Dynamic range: 85 dB

Signal-to-noise ratio: 90 dB

Wow and flutter: Immeasurable

Cassette deck

Frequency response

Normal (type I): 50 Hz – 14 000 Hz

Wow and flutter: 0.15% (WRMS)

General

Power requirement: AC 240 V \sim , 50 Hz

Power consumption: 160 W (at operation)

21 W (on standby with Ecology Mode off)

1.2 W (on standby with Ecology Mode on)

Dimensions (approx.): 205 mm \times 370 mm \times 370 mm (W/H/D)

Mass (approx.): 10.0 kg

Supplied accessories

See page 7.

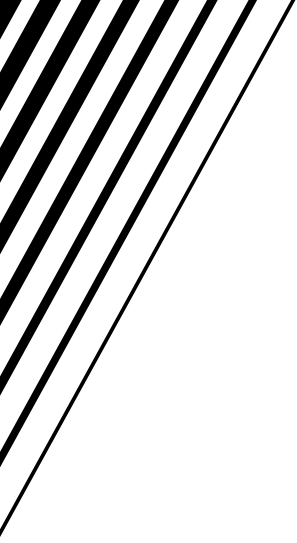

JVC
VICTOR COMPANY OF JAPAN, LIMITED

JVC



COMPACT COMPONENT SYSTEM SISTEMAS DE COMPONENTES COMPACTOS SISTEMA DE COMPONENTE COMPACTO

CA-HXZ1

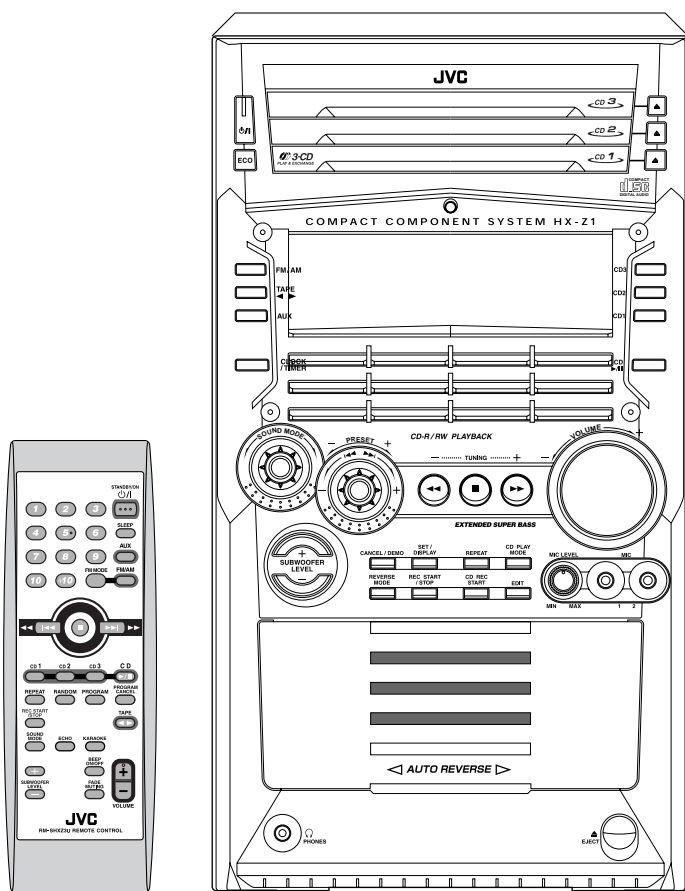

COMPACT
disc
DIGITAL AUDIO

INSTRUCTIONS MANUAL DE INSTRUCCIONES INSTRUÇÕES

For Customer Use:

Enter below the Model No. and Serial No. which are located either on the rear, bottom or side of the cabinet. Retain this information for future reference.

Model No. _____

Serial No. _____

GVT0077-012A
[UW]

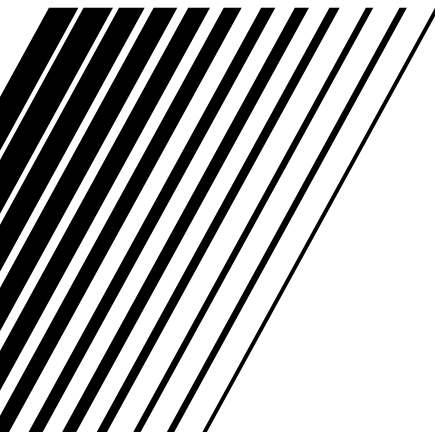

Warnings, Cautions and Others

Avisos, precauciones y otras notas

Advertências, precauções e outras notas

Caution— ⏻/I (standby/on) button!

Disconnect the mains plug to shut the power off completely. The ⏻/I (standby/on) button in any position does not disconnect the mains line. The power can be remote controlled.

Precaución—Interruptor ⏻/I (encendido/apagado)!

Desconectar el cable de alimentación para desactivar la alimentación totalmente. Cualquiera que sea la posición de ajuste del interruptor ⏻/I (encendido/apagado), la alimentación no es cortada completamente. La alimentación puede ser controlada remotamente.

Precaução—Interruptor ⏻/I (esperar/ligar)!

Desconectar o cabo de alimentação para desligar a alimentação por completo. Qualquer que seja a posição de ajuste do interruptor ⏻/I (esperar/ligar), a alimentação não é completamente cortada. A alimentação pode ser controlada remotamente.

CAUTION

To reduce the risk of electrical shocks, fire, etc.:

1. Do not remove screws, covers or cabinet.
2. Do not expose this appliance to rain or moisture.

CAUTION

- Do not block the ventilation openings or holes. (If the ventilation openings or holes are blocked by a newspaper or cloth, etc., the heat may not be able to get out.)
- Do not place any naked flame sources, such as lighted candles, on the apparatus.
- When discarding batteries, environmental problems must be considered and local rules or laws governing the disposal of these batteries must be followed strictly.
- Do not expose this apparatus to rain, moisture, dripping or splashing and that no objects filled with liquids, such as vases, shall be placed on the apparatus.

PRECAUCIÓN

Para reducir riesgos de choques eléctricos, incendio, etc.:

1. No extraiga los tornillos, los cubiertas ni la caja.
2. No exponga este aparato a la lluvia o a la humedad.

PRECAUCIÓN

- No obstruya las rendijas o los orificios de ventilación. (Si las rendijas o los orificios de ventilación quedan tapados con un periódico, un trozo de tela, etc., no se podrá disipar el calor).
- No ponga sobre el aparato ninguna llama al descubierto, como velas encendidas.
- Cuando tenga que descartar las pilas, tenga en cuenta los problemas ambientales y observe estrictamente los reglamentos o las leyes locales sobre disposición de las pilas.
- No exponga este aparato a la lluvia, humedad, goteos o salpicaduras. Tampoco ponga recipientes conteniendo líquidos, como floreros, encima del aparato.

PRECAUÇÃO

Para reduzir riscos de choques elétricos, incêndio, etc.:

1. Não remova parafusos e tampas ou desmonte a caixa.
2. Não exponha este aparelho à chuva nem à umidade.

AVISO

- Não obstrua as aberturas e orifícios de ventilação. (Se os orifícios ou aberturas de ventilação estiverem obstruídos por qualquer papel ou tecido, não haverá circulação do ar quente.)
- Não coloque nenhum objeto com chamas, como velas acesas, sobre o aparelho.
- Ao descartar as baterias, leve em consideração os problemas que possam ser causados ao meio ambiente e os regulamentos e leis locais e governamentais sobre recolhimento dessas baterias devem ser rigorosamente seguidos.
- Não exponha este aparelho à chuva, umidade, pingos ou esguichos de água, nem coloque em cima do mesmo qualquer tipo de recipiente que contenha líquidos, como por exemplo vasos.

Caution: Proper Ventilation

To avoid risk of electric shock and fire, and to prevent damage, locate the apparatus as follows:

- 1 Front: No obstructions and open spacing.
- 2 Sides/ Top/ Back: No obstructions should be placed in the areas shown by the dimensions below.
- 3 Bottom: Place on the level surface. Maintain an adequate air path for ventilation by placing on a stand with a height of 10 cm or more.

Precaución: El aparato debe estar bien ventilado

Para evitar posibles riesgos de descargas eléctricas e incendios y prevenir cualquier posible daño, coloque el aparato del modo siguiente:

- 1 Parte delantera: No ponga nada delante, deje el espacio libre.
- 2 Laterales/ parte superior/ parte trasera: No se debería colocar nada en las áreas y las distancias que se detallan a continuación.
- 3 Parte inferior: Coloque el aparato sobre una superficie recta. Debe haber buena circulación de aire; para ello, coloque el aparato sobre una base a una altura mínima de 10 cm.

Precaução: Ventilação adequada

Para evitar riscos de choques elétricos e incêndios, e prevenir avarias, instale o aparelho como segue:

- 1 Parte frontal: Sem obstruções e espaços abertos.
- 2 Partes laterais/Tampa/Posterior: Nenhuma obstrução deverá ser colocada entre as áreas cujas dimensões são indicadas abaixo.
- 3 Parte inferior: Instale-o sobre uma superfície plana. Deverá ser mantido espaço suficiente para a ventilação se este for instalado numa posição que tenha uma altura de 10 cm ou mais.

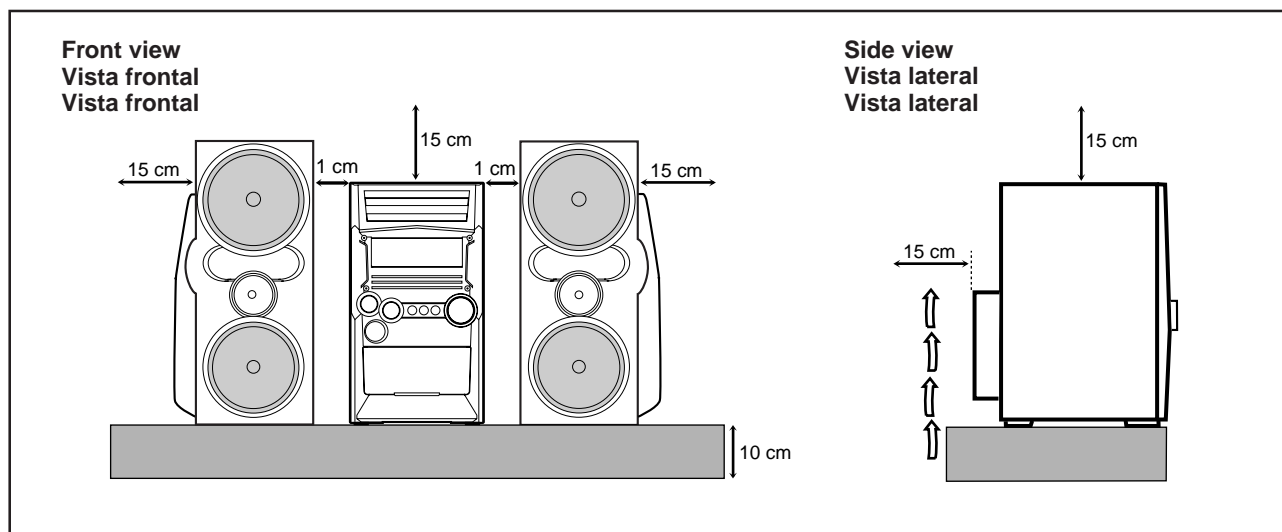

**IMPORTANT FOR LASER PRODUCTS
 IMPORTANTE PARA PRODUCTOS LÁSER
 IMPOTANTE PARA PRODUTOS LASER**

REPRODUCTION OF LABELS / REPRODUCCIÓN DE ETIQUETAS / REPRODUÇÃO DE ETIQUETAS

- | | |
|---|---|
| <p>① CLASSIFICATION LABEL, PLACED ON EXTERIOR SURFACE</p> <p>① ETIQUETA DE CLASIFICACIÓN, PROVISTA SOBRE LA SUPERFICIE EXTERIOR</p> <p>① ETIQUETA DE CLASSIFICAÇÃO LOCALIZADA NA PARTE POSTERIOR DA CAIXA DO APARELHO</p> | <p>② WARNING LABEL, PLACED INSIDE THE UNIT</p> <p>② ETIQUETA DE ADVERTENCIA, PEGADA EN EL INTERIOR DE LA UNIDAD</p> <p>② ETIQUETA DE ADVERTÊNCIA LOCALIZADA NA PARTE INTERNA DA UNIDADE</p> |
|---|---|

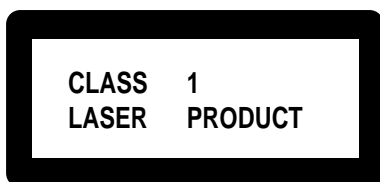

DANGER : Invisible laser radiation when open and interlock failed or defeated. AVOID DIRECT EXPOSURE TO BEAM. (e)

WARNING : Osynlig laserstrålning när denna del är öppnad och spärren är urkopplad. Betrakta ej strålen. (s)

ADVARSEL : Usynlig laserstrålning ved åbning, når sikkerhedsafbrydere er ude af funktion. Undgåudsættelse for stråling. (d)

VARO : Avattaessa ja suojalukitus ohitettaessa olet alttiina näkymättömälle lasersäteilylle. Älä katso säteeseen. (f)

- | | |
|--|--|
| <p>1. CLASS 1 LASER PRODUCT</p> <p>2. DANGER: Invisible laser radiation when open and interlock failed or defeated. Avoid direct exposure to beam.</p> <p>3. CAUTION: Do not open the top cover. There are no user serviceable parts inside the Unit; leave all servicing to qualified service personnel.</p> | <p>1. PRODUCTO LÁSER CLASE 1</p> <p>2. PELIGRO: En el interior hay radiación láser invisible. Evite el contacto directo con el haz.</p> <p>3. PRECAUCIÓN: No abra la tapa superior. En el interior de la unidad no existen piezas reparables por el usuario; deje todo servicio técnico en manos de personal calificado.</p> |
| <p>1. PRODUTO LASER CLASSE 1</p> <p>2. PERIGO: O laser emite uma radiação invisível que é perigosa, caso o aparelho esteja aberto e a trava inoperante ou danificada. Evite exposição direta ao feixe dos raios.</p> <p>3. CUIDADO: Não abra a caixa do aparelho. Não existem peças reparáveis pelo usuário na parte interna da unidade. Solicite assistência técnica somente a pessoal técnico qualificado.</p> | |

Introduction

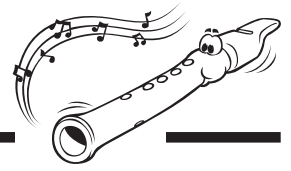

We would like to thank you for purchasing one of our JVC products. Before operating this unit, read this manual carefully and thoroughly to obtain the best possible performance from your unit, and retain this manual for future reference.

About This Manual

This manual is organized as follows:

- The manual mainly explains operations using the buttons and controls on the unit. You can also use the buttons on the remote control if they have the same or similar names (or marks) as those on the unit. If operation using the remote control is different from that using the unit, it is then explained.
- Basic and common information that is the same for many functions is grouped in one place, and is not repeated in each procedure. For instance, we do not repeat the information about turning on/off the unit, setting the volume, changing the sound effects, and others, which are explained in the section “Common Operations” on pages 9 to 11.
- The following marks are used in this manual:



Gives you warnings and cautions to prevent from damage or risk of fire/electric shock. Also gives you information which is not good for obtaining the best possible performance from the unit.



Gives you information and hints you had better know.

Precautions

Installation

- Install in a place which is level, dry and neither too hot nor too cold—between 5°C and 35°C.
- Install the unit in a location with adequate ventilation to prevent internal heat buildup in the unit.
- Leave sufficient distance between the unit and the TV.
- Keep the speakers away from the TV to avoid interference with TV.



DO NOT install the unit in a location near heat sources, or in a place subject to direct sunlight, excessive dust or vibration.

Power sources

- When unplugging from the wall outlet, always pull the plug, not the AC power cord.



DO NOT handle the AC power cord with wet hands.

Moisture condensation

Moisture may condense on the lens inside the unit in the following cases:

- After heating starts in the room
 - In a damp room
 - If the unit is brought directly from a cold to a warm place
- Should this occur, the unit may malfunction. In this case, leave the unit turned on for a few hours until the moisture evaporates, unplug the AC power cord, and then plug it in again.

Internal heat

A cooling fan is mounted on the rear panel to prevent heat buildup inside the unit.



For safety, observe the following carefully:

- Make sure there is good ventilation around the unit. Poor ventilation could overheat and damage the unit.
- DO NOT block the cooling fan and the ventilation openings or holes. If they are blocked by a newspaper or cloth, etc., the heat may not be able to get out.

Others

- Should any metallic object or liquid fall into the unit, unplug the unit and consult your dealer before operating any further.
- If you are not going to operate the unit for an extended period of time, unplug the AC power cord from the wall outlet.



DO NOT disassemble the unit since there are no user serviceable parts inside.

If anything goes wrong, unplug the AC power cord and consult your dealer.

Contents

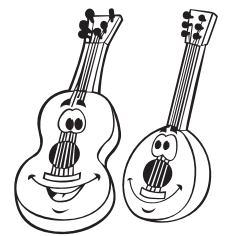

Location of the Buttons and Controls	3	Playing Back Tapes	18
Front Panel	3	Playing Back a Tape	18
Remote Control	5	Locating the Beginning of a Song—Music Scan	18
Getting Started	6	Recording	19
Supplied Accessories	6	Recording on a Tape	19
Putting the Batteries into the Remote Control	6	CD Synchronized Recording	20
Connecting Antennas	6	■ CD Direct Recording	20
Connecting Speakers	7	■ Auto Edit Recording	21
Connecting Other Equipment	8	Using the Microphones	22
Adjusting the Voltage Selector	8	Singing along—Karaoke	22
Canceling the Demonstration	8	■ Vocal Masking	22
Common Operations	9	■ Microphone Mixing	22
Turning On or Off the Power	9	Using the Timers	23
Saving the Power Consumption while on Standby		Using Daily Timer	23
—Ecology Mode	9	Using Recording Timer	25
Turning On or Off the Key-touch Tone	9	Using Sleep Timer	26
Setting the Clock	9	Timer Priority	26
Selecting the Sources	10	Maintenance	27
Adjusting the Volume	10	Troubleshooting	28
Reinforcing the Bass Sound	10	Specifications	28
Selecting the Sound Modes	10		
Creating Your Own Sound Mode—User Mode	11		
Setting the AM Tuner Interval Spacing	11		
Listening to FM and AM Broadcasts	12		
Tuning in to a Station	12		
Presetting Stations	12		
Tuning in to a Preset Station	12		
Playing Back CDs (CD/CD-R/CD-RW)	13		
Loading CDs	13		
Playing Back the Entire Discs—Continuous Play ...	14		
Basic CD Operations	14		
Programming the Playing Order of the Tracks			
—Program Play	15		
Playing at Random—Random Play	16		
Repeating Tracks or CDs—Repeat Play	17		
Prohibiting Disc Ejection—Tray Lock	17		

Location of the Buttons and Controls

Become familiar with the buttons and controls on your unit.

Front Panel

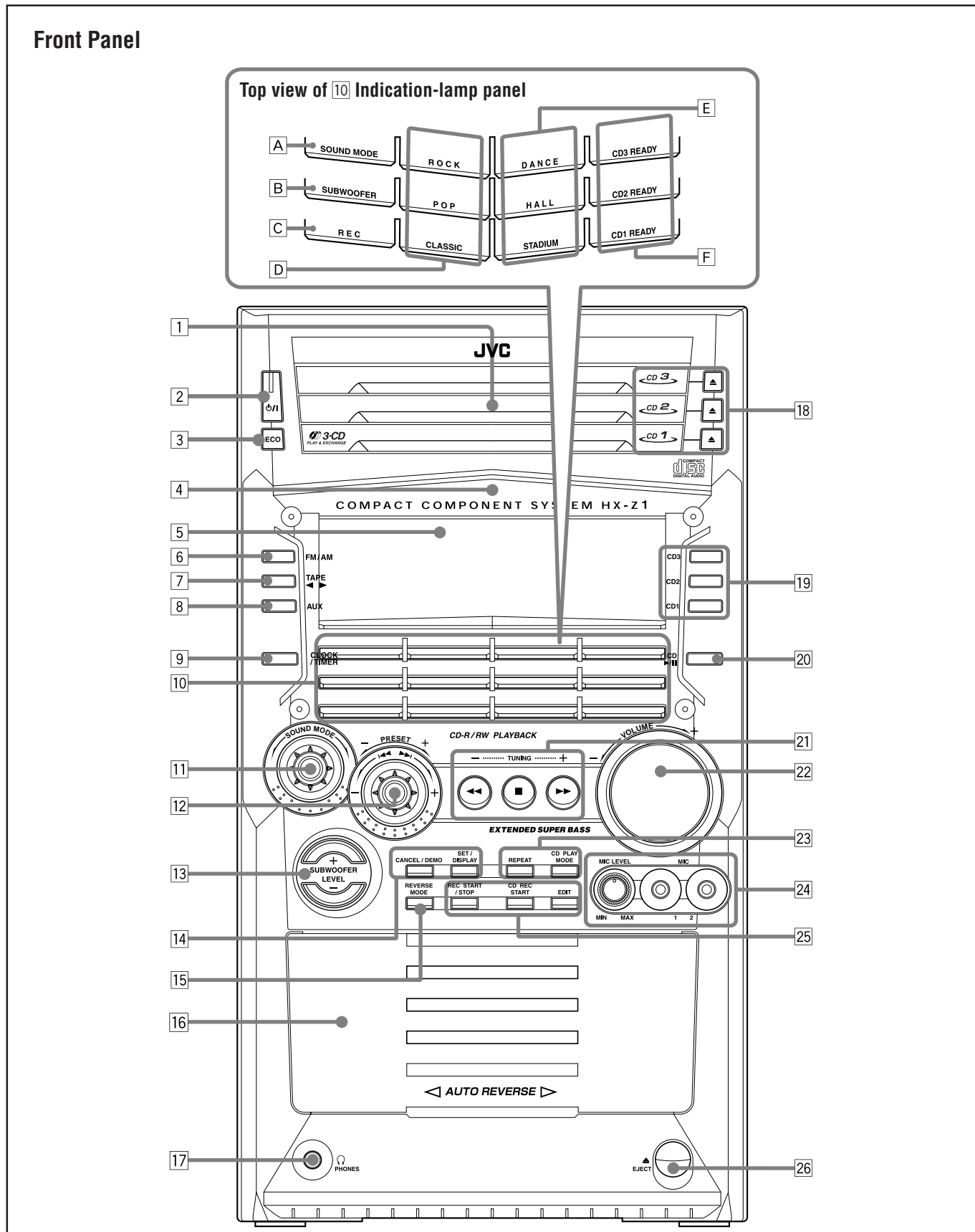

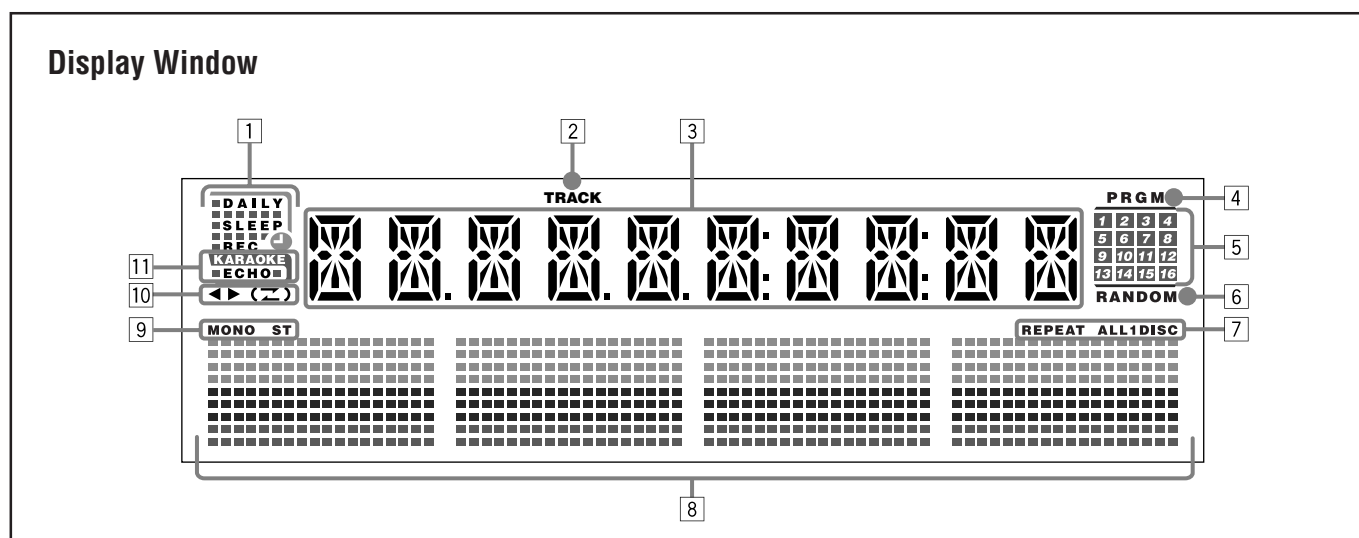

See pages in the parentheses for details.

Front Panel

- 1 Disc trays
- 2 O/I (standby/on) button and lamp (9, 11, 24, 25)
- 3 ECO (Ecology) button (9)
- 4 Remote sensor
- 5 Display window
- 6 FM/AM button (10, 12)
Pressing this button also turns on the unit.
- 7 TAPE $\blacktriangleleft/\blacktriangleright$ button (10, 18, 19)
Pressing this button also turns on the unit.
- 8 AUX button (10)
Pressing this button also turns on the unit.
- 9 CLOCK/TIMER button (9, 23 – 26)
- 10 Indication-lamp panel
 - A SOUND MODE lamp (10)
 - B SUBWOOFER lamp (10)
 - C REC (recording) lamp (19 – 21)
 - D SEA (Sound Effect Amplifier) mode lamps (10)
 - ROCK, POP, and CLASSIC lamps
 - E Surround mode lamps (10)
 - DANCE, HALL, and STADIUM lamps
 - F CD ready lamps (13)
 - CD1 READY, CD2 READY, and CD3 READY lamps
- 11 SOUND MODE control (10)
- 12 PRESET + / – control (12)
 $\blacktriangleleft/\blacktriangleright$ (reverse skip/forward skip) control (9, 11, 14 – 16, 21, 23 – 25)
- 13 SUBWOOFER LEVEL + / – buttons (10)
- 14 Setting buttons (8, 9, 11, 12, 15, 16, 21, 23 – 26)
 - CANCEL/DEMO and SET/DISPLAY buttons
- 15 REVERSE MODE button (18 – 21)
- 16 Cassette holder (18 – 21)
- 17 PHONES (Q) jack (10)
- 18 \blacktriangle (Disc tray open/close) (CD1, CD2, and CD3) buttons (13, 14, 17)
Pressing one of these buttons also turns on the unit.
- 19 Disc number (CD1, CD2, and CD3) buttons (14, 15, 20, 21)
Pressing one of these buttons also turns on the unit.

- 20 CD $\blacktriangleright/\parallel$ button (10, 14 – 16, 21, 22)
Pressing this button also turns on the unit.
- 21 TUNING + / – buttons (12)
 $\blacktriangleleft/\blacktriangleright$ (reverse search/forward search) buttons (11, 14, 18)
 \blacksquare (stop) button (11, 14 – 22, 25)
- 22 VOLUME + / – control (10, 22)
- 23 CD play mode buttons (15 – 17)
 - REPEAT and CD PLAY MODE buttons
- 24 MIC LEVEL control (22)
MIC 1 and MIC 2 jacks (22)
- 25 Recording buttons (19 – 22, 25)
 - REC START/STOP, CD REC START, and EDIT buttons
- 26 \blacktriangle EJECT button for cassette deck (18 – 20)

Display Window

- 1 Timer indicators
 - DAILY (Daily Timer), SLEEP (Sleep Timer), REC (Recording Timer), and O (Timer) indicators
- 2 TRACK indicator
- 3 Main display
 - Shows the source name, frequency, etc.
- 4 PRGM (program) indicator
- 5 CD track number (1 – 16) indicators
- 6 RANDOM indicator
- 7 REPEAT (ALL/1/DISC) indicators
- 8 Audio level indicator
When one of the 6 preset sound modes is activated, these will function as display illumination. For details, see “Selecting the Sound Modes” on pages 10 and 11.
- 9 Tuner operation indicators
 - MONO and ST (stereo) indicators
- 10 Tape operation indicators
 - $\blacktriangleleft/\blacktriangleright$ (tape direction) and $\blacktriangleleft/\blacktriangleright$ (reverse mode) indicators
- 11 KARAOKE and ECHO indicators



Remote Control

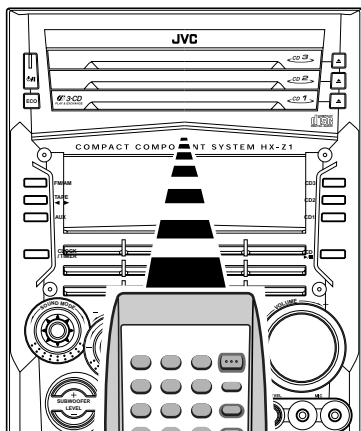
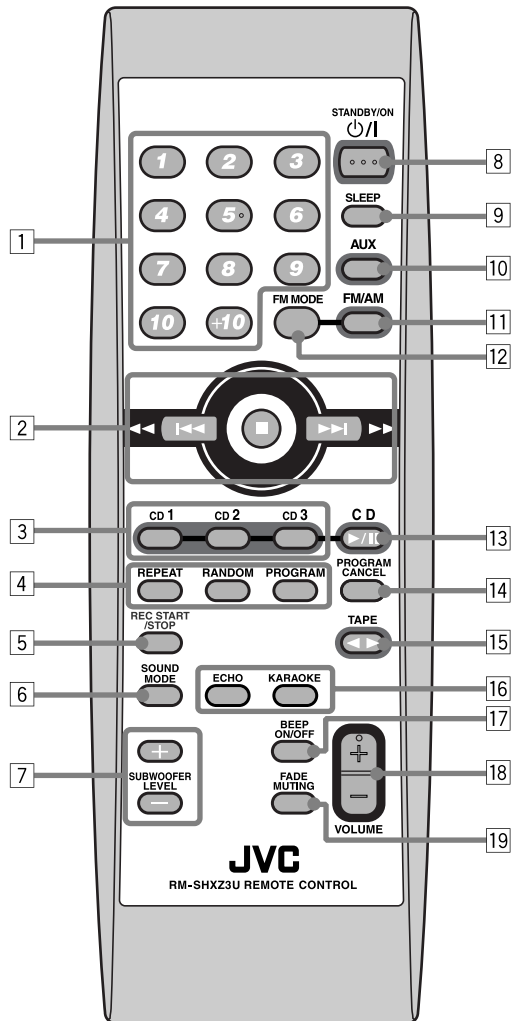

When using the remote control, point it at the remote sensor on the front panel.

Remote Control

- 1 Number buttons (12, 14, 15)
- 2 ◀◀ (◀◀) (reverse skip/reverse search) button (12, 14, 16, 18)
 - (stop) button (14 – 16, 18 – 22, 25)
 - ▶▶ (▶▶) (forward skip/forward search) button (12, 14, 16, 18)
- 3 Disc number (CD1, CD2, and CD3) buttons (14, 15)
- 4 CD play mode buttons (15 – 17)
 - REPEAT, RANDOM and PROGRAM buttons
- 5 REC START/STOP button (19, 21, 22, 25)
- 6 SOUND MODE button (10)
- 7 SUBWOOFER LEVEL + / – buttons (10)
- 8 STANDBY/ON ⏻/⏻ button (9)
- 9 SLEEP button (26)
- 10 AUX button (10)
- 11 FM/AM button (10, 12)
- 12 FM MODE button (12)
- 13 CD ▶/|| button (10, 14 – 16, 22)
- 14 PROGRAM CANCEL button (16)
- 15 TAPE ◀▶ button (10, 18, 19)
- 16 ECHO button (22)
 - KARAOKE button (22)
- 17 BEEP ON/OFF button (8, 9)
- 18 VOLUME + / – button (10, 22)
- 19 FADE MUTING button (10)

Supplied Accessories

Make sure that you have all the following items. The number in the parentheses indicates the quantity of the pieces supplied.

- AM loop antenna (1)
- FM antenna (1)
- Remote control (1)
- Batteries (2)
- AC plug adaptor (1)

If anything is missing, consult your dealer immediately.

Putting the Batteries into the Remote Control

Insert the batteries—R6(SUM-3)/AA(15F)—into the remote control, by matching the polarity (+ and –) on the batteries with the + and – markings on the battery compartment. When the remote control can no longer operate the unit, replace both batteries at the same time.

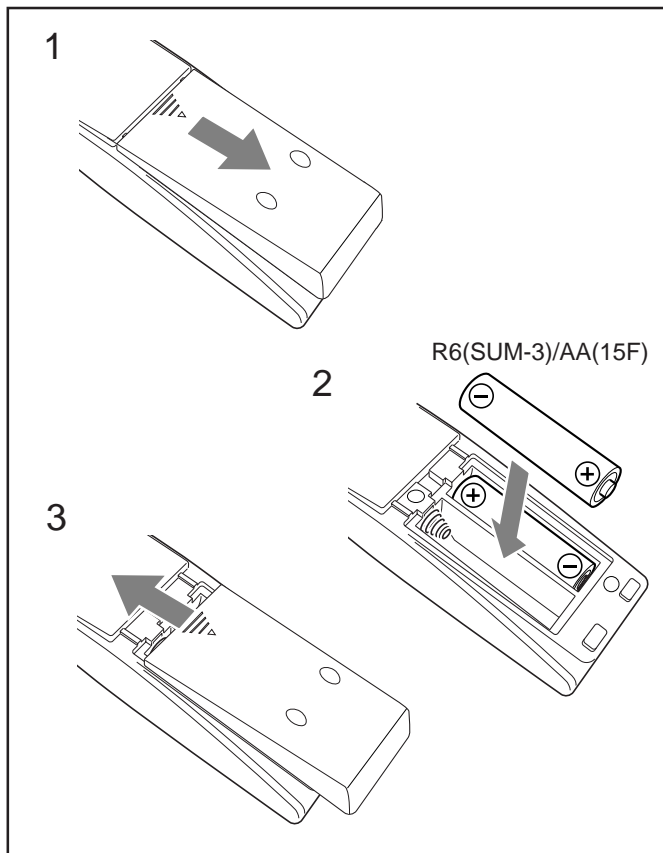

- DO NOT use an old battery together with a new one.
- DO NOT use different types of batteries together.
- DO NOT expose batteries to heat or flame.
- DO NOT leave the batteries in the battery compartment when you are not going to use the remote control for an extended period of time. Otherwise, it will be damaged from battery leakage.

Connecting Antennas

FM antenna

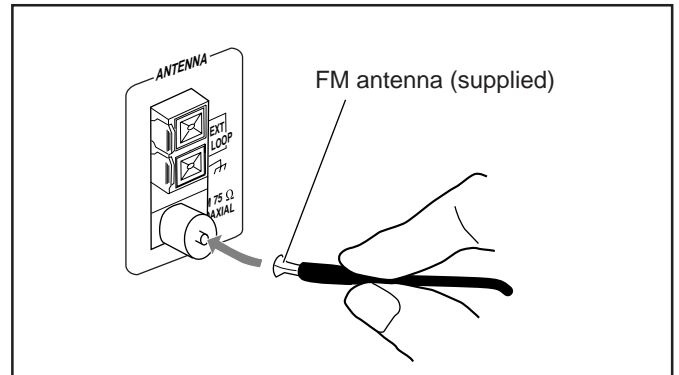

- 1 Attach the FM antenna to the FM 75 Ω COAXIAL terminal.
- 2 Extend the FM antenna.
- 3 Fasten it up in the position which gives you the best reception, then fix it on the wall, etc.



About the supplied FM antenna

The FM antenna supplied with this unit can be used as temporary measure. If reception is poor, you can connect an outdoor FM antenna.

To connect an outdoor FM antenna

Before connecting it, disconnect the supplied FM antenna.

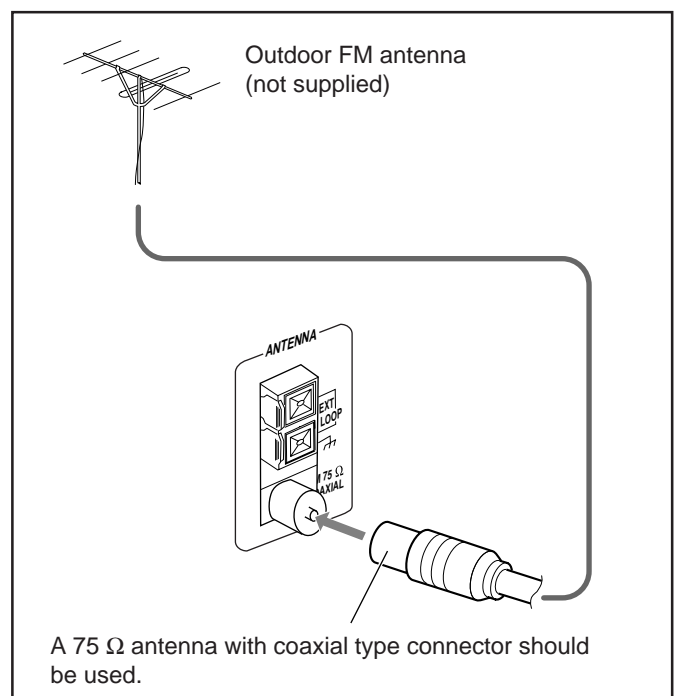

AM antenna

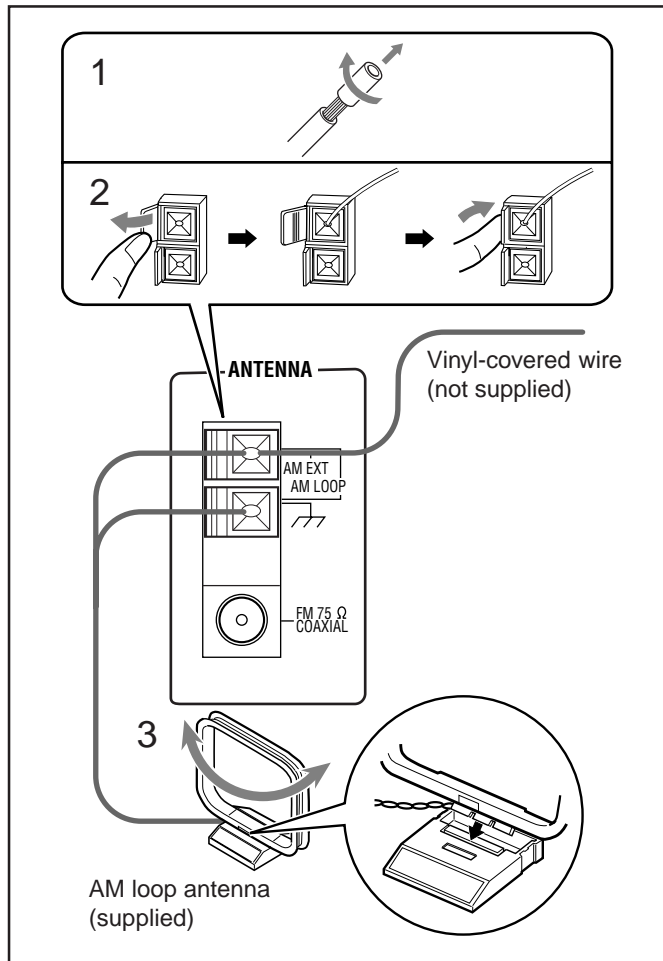

- 1 If cords are covered with insulation, twist the core of the cord at the end of each cord, then remove the insulation.
- 2 Connect the AM loop antenna to the AM LOOP terminals as illustrated.
- 3 Turn the AM loop antenna until you have the best reception.

To connect an outdoor AM antenna

When reception is poor, connect a single vinyl-covered wire to the AM EXT terminal and extend it horizontally. The AM loop antenna must remain connected.



For better reception of both FM and AM

- Make sure the antenna conductors do not touch any other terminals and connecting cords.
- Keep the antennas away from metallic parts of the unit, connecting cords, and the AC power cord.

Connecting Speakers

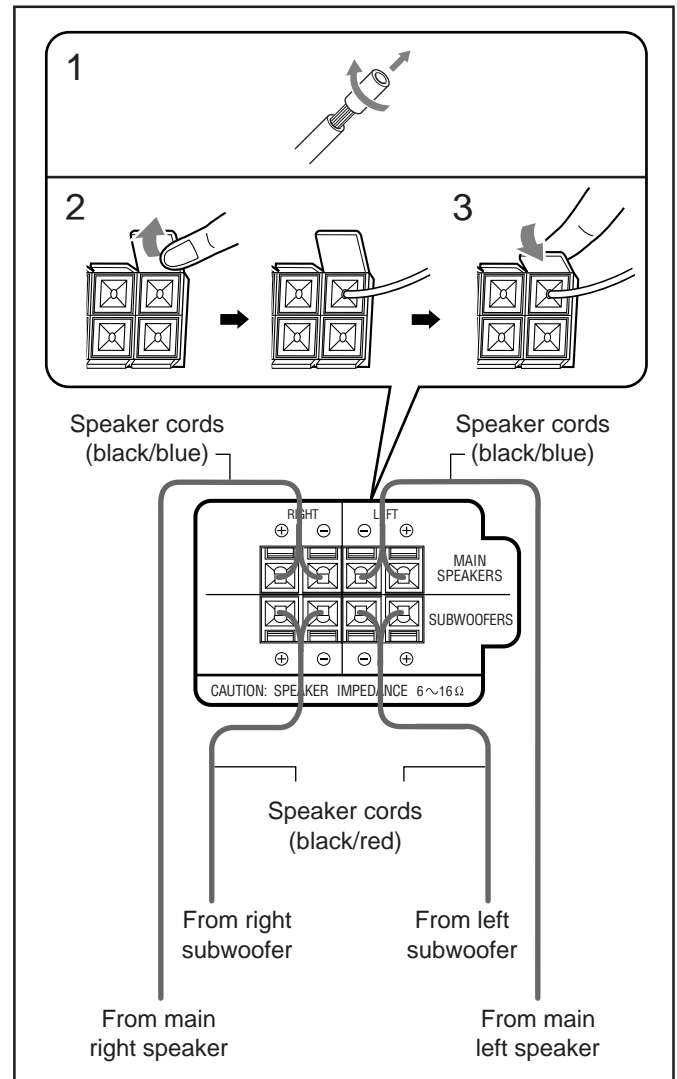

- 1 If cords are covered with insulation, twist the core of the cord at the end of each cord, then remove the insulation.
- 2 Insert the end of the speaker cord into the terminal as illustrated.
Match the same polarity: (+) to (+) and (-) to (-).
- 3 Close the speaker terminals.

IMPORTANT: Use only speakers with the same speaker impedance as indicated by the speaker terminals on the rear of the unit.



- DO NOT connect more than one speaker to each speaker terminal.
- DO NOT push or pull the speakers as this will damage the foot spacers at the bottom of the speakers.



Connecting Other Equipment

You can connect both analog and digital equipment.



- DO NOT connect any equipment while the power is on.
- DO NOT plug in any equipment until all connections are complete.

To connect an analog component

Be sure that the plugs of the audio cords are colored: White plugs and jacks are for left audio signals, and red ones for right audio signals.

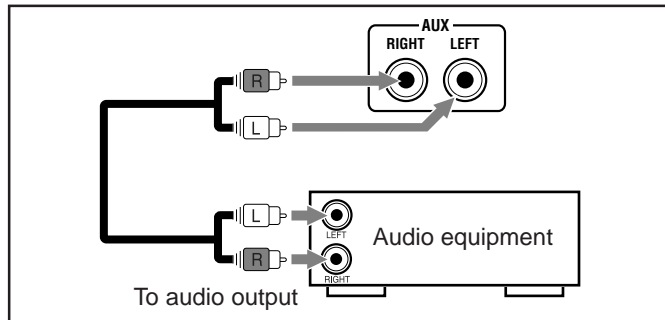

For playing the other equipment through this unit, connect between the audio output jacks on the other equipment and AUX jacks by using an audio cord (not supplied).

To connect audio equipment with an optical digital input terminal

You can record CD sound onto the connected digital equipment.

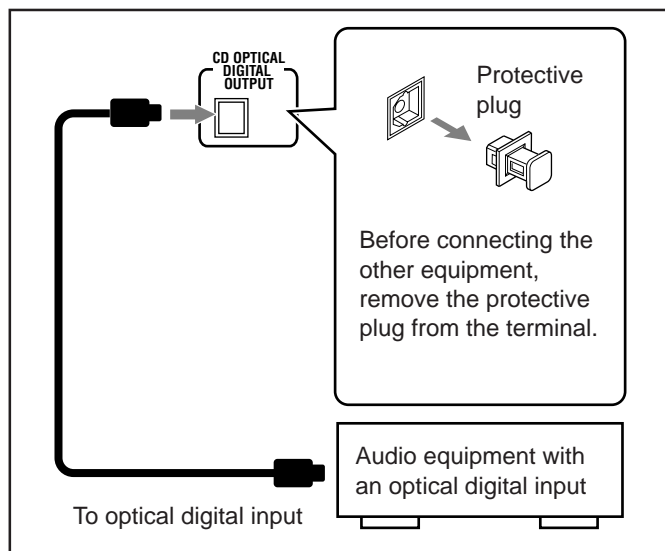

Connect an optical digital cord (not supplied) between the optical digital input terminal on the other equipment and the CD OPTICAL DIGITAL OUTPUT terminal.

Adjusting the Voltage Selector

Before plugging in the unit, set the correct voltage for your area with the voltage selector on the rear of the unit.

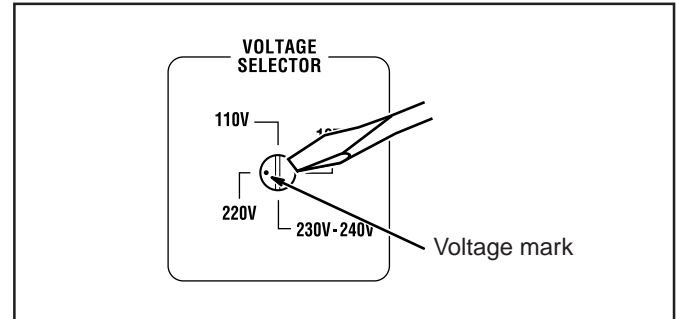

Use a screwdriver to rotate the voltage selector so that the voltage number and the voltage mark is pointing at is the same as the voltage where you are plugging in the unit. (See the back cover page.)



- DO NOT plug in before setting the voltage selector on the rear of the unit and all connection procedures are complete.

Now, you can plug the AC power cord.

- If the wall outlet does not match the AC plug, use the supplied AC plug adaptor.

IMPORTANT: Be sure to check all connections to be done before plugging the AC power cord into a wall outlet.

Canceling the Demonstration

When connecting the AC power cord into a wall outlet, the unit automatically starts the demonstration.

To cancel the demonstration, press and hold CANCEL/DEMO until "DEMO OFF" appears on the display.



- To cancel only beep sounds during the demonstration, press BEEP ON/OFF on the remote control.



When you press other buttons



The demonstration stops temporarily. It will start automatically again (if no operation is done for 2 minutes) unless you cancel it by pressing CANCEL/DEMO.

To start the demonstration manually

Press and hold CANCEL/DEMO again until "DEMO START" appears on the display.



Common Operations

Turning On or Off the Power

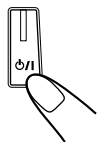
To turn on the unit, press  (or STANDBY/ON  on the remote control) so that the lamp on the button goes off.



POWER ON

To turn off the unit (on standby), press  (or STANDBY/ON  on the remote control) again so that the lamp on the button lights up.

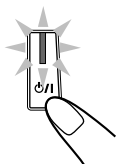

- A little power is always consumed even while the unit is on standby.

To switch off the power supply completely, unplug the AC power cord from the AC outlet.



When you unplug the AC power cord or if a power failure occurs

The clock is reset to “0:00” right away, while the tuner preset stations (see page 12) will be erased in a few days.

Saving the Power Consumption while on Standby — Ecology Mode

You can save the power consumption while the unit is turned off (on standby).

- You can set Ecology Mode whether the unit is on or off.

On the unit ONLY:

To activate the Ecology Mode, press ECO. “ECO” appears on the display for 2 seconds (and the demonstration is canceled if you have pressed the button while the unit is off).



- Each time you press the button, “ECO” and “NORMAL” appear alternately on the display.

To deactivate the Ecology Mode, press ECO again. “NORMAL” appears (and the demonstration starts if the unit is turned off).



When you turn off the unit with Ecology Mode activated “ECO” flashes on the display, and the clock time will not be shown while the unit is turned off.

Turning On or Off the Key-touch Tone

If you do not want the key-touch tone to beep each time you press a button, you can deactivate it.

On the remote control ONLY:

Press BEEP ON/OFF.

- Each time you press the button, the key-touch tone turns on and off alternately.



Setting the Clock

You can set the clock whether the unit is on or off; however, if Ecology Mode is activated, you cannot set the clock while the unit is off. “0:00” flashes on the display until you set the clock.

On the unit ONLY:

1 Press CLOCK/TIMER.

The hour digits start flashing on the display.

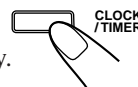

0:00

2 Turn / to adjust the hour, then press SET/DISPLAY.

The minute digits start flashing on the display.

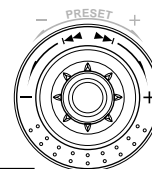

17:30

If you want to correct the hour after pressing SET/DISPLAY, press CANCEL/DEMO.



The hour digits start flashing again.

3 Turn / to adjust the minute, then press SET/DISPLAY.

CLOCK OK

To check the clock time

Press and hold SET/DISPLAY while playing any source.

- Each time you press and hold the button, the source indication and the clock time alternate on the display.

To adjust the clock again

If you have set the clock before, you need to press CLOCK/TIMER repeatedly until the clock setting mode is selected.

- Each time you press the button, the clock/timer setting modes change as follows:

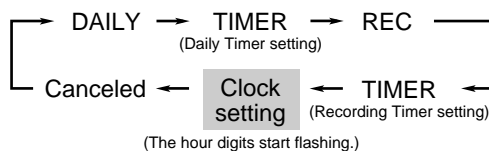

When you unplug the AC power cord or if a power failure occurs

The clock loses the setting and is reset to “0:00.” If this happens, set the clock again.

Selecting the Sources

To listen to the FM/AM broadcasts, press FM/AM.

(See page 12.)

To play back CDs, press CD ►/II. (See pages 13 – 17.)

To play back tapes, press TAPE ◀▶. (See page 18.)

To select the external equipment as the source, press AUX.

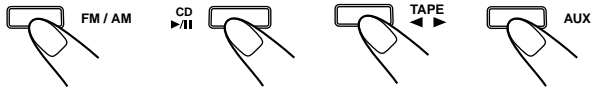

When you press the play button for a particular source (FM/AM, CD ►/II, TAPE ◀▶, and AUX), the unit turns on and the unit starts playing the source if it is ready.

Adjusting the Volume

You can adjust the volume level only while the unit is turned on. The volume level can be adjusted in 32 steps (VOLUME MIN, VOLUME 1 – VOLUME 30, and VOLUME MAX).

Turn VOLUME + / – clockwise (+) to increase the volume or counterclockwise (–) to decrease it.

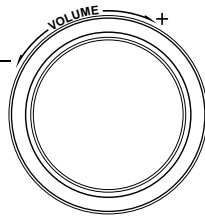

When using the remote control, press VOLUME + to increase the volume or VOLUME – to decrease it.

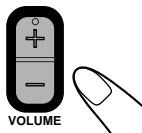

For private listening

Connect a pair of headphones to the PHONES (🔊) jack. No sound comes out of the speakers. Be sure to turn down the volume before connecting or putting on headphones.



DO NOT turn off (on standby) the unit with the volume set to an extremely high level; otherwise, a sudden blast of sound can damage your hearing, speakers and/or headphones when you turn on the unit or start playing any source next time. REMEMBER, you cannot adjust the volume level while the unit is off (on standby).

To turn down the volume level temporarily

On the remote control ONLY:

Press FADE MUTING.

The volume level gradually decreases to “VOLUME MIN.”



To restore the sound, press the button again.

Reinforcing the Bass Sound

You can select one of the 5 subwoofer levels. This function only affects the playback sound, but does not affect your recording. The subwoofer level can be adjusted in 5 steps—LEVEL 0 (MIN LEVEL), LEVEL 1, LEVEL 2, LEVEL 3, and LEVEL 4 (MAX LEVEL).

Press SUBWOOFER LEVEL + to increase the subwoofer level or SUBWOOFER LEVEL – to decrease it.

SUBWOOFER lamp lights up in red

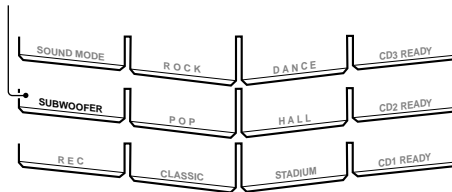

- The SUBWOOFER lamp lights up in red when LEVEL 1 to LEVEL 4 (MAX LEVEL) is selected. The lamp turns off when LEVEL 0 (MIN LEVEL) is selected.

Selecting the Sound Modes

You can select one of the 6 preset sound modes (3 surround modes and 3 SEA—Sound Effect Amplifier—modes) and 3 user modes. This function only affects the playback sound, but does not affect your recording. Each Sound Mode has its own display illumination.

To select the sound modes, turn SOUND MODE (or press SOUND MODE on the remote control) until the sound mode you want appears on the display.

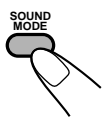
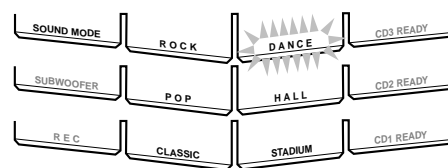
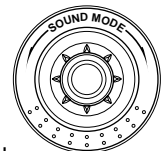

- When a sound mode is selected, the lamp for the selected sound mode (in this example, DANCE) flashes while the SOUND MODE and the other sound mode lamps remains lit.
- When one of the user modes (USER 1, USER 2, or USER 3) is selected, only the SOUND MODE lamp lights up (no sound mode lamps light up).
- When the sound mode is canceled (“OFF” is selected), all sound mode lamps including the SOUND MODE lamp go off.

The sound modes change as follows:

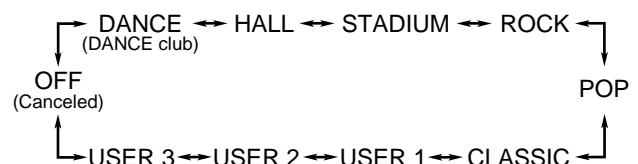

When using the remote control, the sound mode changes only clockwise in the above sequence.

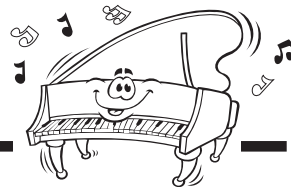

Surround modes*

- DANCE:** Increases resonance and bass.
HALL: Adds depth and brilliance to the sound.
STADIUM: Adds clarity and spreads the sound, like in an outdoor stadium.

SEA (Sound Effect Amplifier) modes

- ROCK:** Boosts low and high frequency. Good for acoustic music.
POP: Good for vocal music.
CLASSIC: Good for classical music.

User Modes

USER 1/2/3: Your individual mode stored in memory. See “Creating Your Own Sound Mode—User Mode” below.

OFF: The sound mode is canceled.

* Surround elements are added to the SEA elements to create a being-there feeling in your room.

2) Press ◀◀ or ▶▶ to adjust the level (–3 to +3) of the selected frequency range.

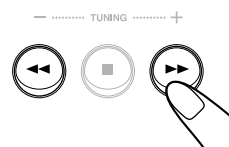

3) Repeat steps 1) and 2) to adjust the level of the other frequency ranges.

4 Press SET/DISPLAY again.

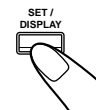
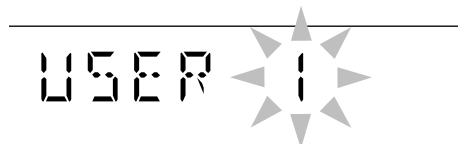

5 Turn ◀◀ / ▶▶ to select one of the user modes (USER 1, USER 2, and USER 3) in which you want to store your SEA pattern.

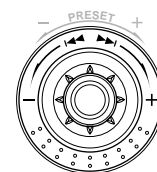

6 Press SET/DISPLAY again.

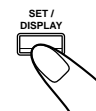

The SEA pattern you have created are stored into the user mode selected in the above step.

Creating Your Own Sound Mode—User Mode

You can change SEA pattern to suit your preference. The SEA pattern can be adjusted into 5 frequency ranges—LOW1, LOW2, MID, HIGH1, and HIGH2. These changed settings can be stored in the USER 1, USER 2, and USER 3 modes.

- There is a time limit in doing the following steps. If the setting is canceled before you finish, start from step 1 again.

On the unit ONLY:

1 Select one of the preset sound modes.

- If you want to add the surround elements in your SEA pattern, select one of the surround modes (DANCE, HALL, or STADIUM) before starting the procedure below. (See “Selecting the Sound Modes” on page 10.)

2 Press SET/DISPLAY while the selected sound mode is still shown on the display.

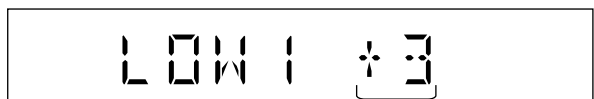
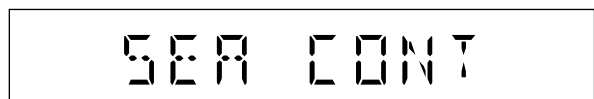
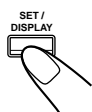

Current level appears.

3 Adjust the SEA pattern.

- 1) Turn ◀◀ / ▶▶ to select the frequency range (LOW1, LOW2, MID, HIGH1, and HIGH2).

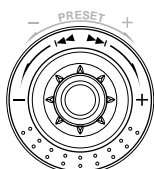

To use your own sound mode

Select USER 1, USER 2, or USER 3 mode when using the sound modes. See “Selecting the Sound Modes” on page 10.



When you unplug the AC power cord or if a power failure occurs

The setting will be erased in a few days. If this happens, set the user modes again.

Setting the AM Tuner Interval Spacing

Some countries space AM stations 9 kHz apart, and some countries use 10 kHz spacing.

On the unit ONLY:

You can only change the AM tuner interval spacing while tuning in to an AM station. (See page 12.)

Press ◻/I while holding down ■.

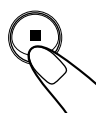

- Each time you press these buttons, the AM tuner interval spacing alternates between 9 kHz and 10 kHz.

Listening to FM and AM Broadcasts



Tuning in to a Station

1 Press FM/AM.

The unit automatically turns on and tunes in to the previously received station (either FM or AM).

- Each time you press the button, the band alternates between FM and AM.

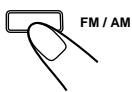

2 Start searching for stations.

On the unit:

Press and hold TUNING + or TUNING – for more than 1 second.

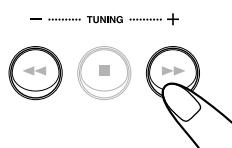

On the remote control:

Press and hold >>> (▶▶▶) or <<< (◀◀◀) for more than 1 second.

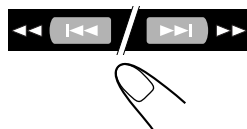

The unit starts searching for stations and stops when a station of sufficient signal strength is tuned in.

- If a program is broadcast in stereo, the ST (stereo) indicator lights up.

To stop searching, press TUNING + or TUNING – (or >>> (▶▶▶) / <<< (◀◀◀) on the remote control).



When you press TUNING + or TUNING – (or >>> (▶▶▶) / <<< (◀◀◀) on the remote control) briefly and repeatedly the frequency changes step by step.

To change the FM reception mode

On the remote control ONLY:

When an FM stereo broadcast is hard to receive or noisy, press FM MODE so that the MONO indicator lights up on the display. Reception improves.

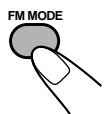

To restore the stereo effect, press FM MODE again so that the MONO indicator goes off. In this stereo mode, you can hear stereo sounds when a program is broadcasted.

Presetting Stations

You can preset 30 FM and 15 AM stations.

In some cases, test frequencies have been already memorized for the tuner since the factory examined the tuner preset function before shipment. This is not a malfunction. You can preset the stations you want into memory by following the presetting method.

- There is a time limit in doing the following steps. If the setting is canceled before you finish, start from step 2 again.

On the unit ONLY:

1 Tune in to the station you want to preset.

- See “Tuning in to a Station.”

2 Press SET/DISPLAY.

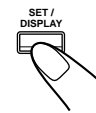
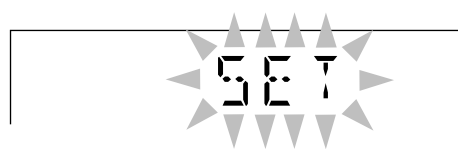

3 Turn PRESET + / – to select a preset number.

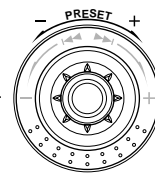
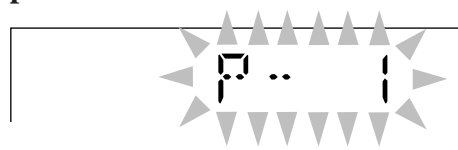

4 Press SET/DISPLAY again.

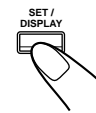

The tuned station in step 1 is stored in the preset number selected in step 3.

- Storing a new station on a used number erases the previously stored one.



When you unplug the AC power cord or if a power failure occurs

The preset stations will be erased in a few days. If this happens, preset the stations again.

Tuning in to a Preset Station

1 Press FM/AM.

The unit automatically turns on and tunes in to the previously received station (either FM or AM).

- Each time you press the button, the band alternates between FM and AM.

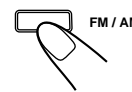

2 Select a preset number.

On the unit:

Turn PRESET + / –.

On the remote control:

Press the number buttons.

Ex.: For preset number 5, press 5.

For preset number 15, press +10, then 5.

For preset number 25, press +10, +10, then 5.

For preset number 30, press +10, +10, then 10.

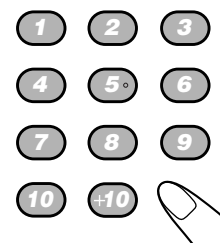
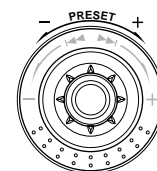

Playing Back CDs (CD/CD-R/CD-RW)

This unit has been designed to play back the following CDs:

- CD (Audio CD)
- CD-R (CD-Recordable)
- CD-RW (CD-ReWritable)

Continued use of irregular shape CDs (heart-shape, octagonal, etc.) can damage the unit.

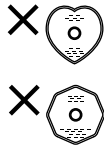

When playing a CD-R or CD-RW

User-edited CD-Rs (CD-Recordable) and CD-RWs (CD-ReWritable) can be played back only if they are already “finalized.”

- You can play back your original CD-Rs or CD-RWs recorded in music CD format. (However, they may not be played back depending on their characteristics or recording conditions.)
- Before playing back CD-Rs or CD-RWs, read their instructions or cautions carefully.
- Some CD-Rs or CD-RWs may not be played back on this unit because of their disc characteristics, damage or stain on them, or if the player’s lens is dirty.
- CD-RWs may require a longer readout time. This is caused by the fact that the reflectance of CD-RWs is lower than for regular CDs.

Loading CDs

On the unit ONLY:

- 1 Press ▲ for the disc tray (CD1, CD2, and CD3) you want to load a CD onto.**

The unit automatically turns on and the disc tray comes out.



- 2 Place a disc correctly on the circle of the disc tray, with its label side up.**

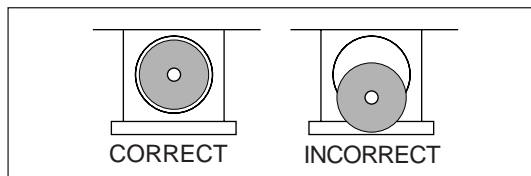

- When using a CD single (8 cm), place it on the inner circle of the disc tray.

- 3 Press the same ▲ you have pressed in step 1.**

The disc tray closes.

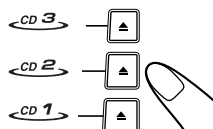

- 4 Repeat steps 1 to 3 to place other CDs.**



When loading more than one CD continuously

When you press ▲ for the next tray you want to place another CD onto, the first disc tray automatically closes and then the next tray comes out.

About the CD ready lamps

Each CD ready lamp corresponds to the disc tray of the same number.

• When and why they light up?

- When you turn on the unit for the first time after plugging into a wall outlet, all CD ready lamps (CD1 READY, CD2 READY, and CD3 READY) lights up. From the next time on, CD ready lamp(s) light(s) up according to the previous condition.
- Each time you press the CD eject buttons—▲ (CD1, CD2, and CD3), the corresponding CD ready lamp lights up.

• When and why they go off?

Only when the unit detects there is no CD loaded on a certain tray, the corresponding CD ready lamp goes off. (“NO DISC 1,” “NO DISC 2,” or “NO DISC 3” appears on the display.)

• When and why they flash?

The corresponding CD ready lamp flashes during playback and pause.

Playing Back the Entire Discs—Continuous Play

You can play CDs continuously.

1 Load CDs.

2 Press one of the disc number (CD1, CD2, and CD3) buttons for the disc you want to play.

The unit starts searching for the CD and CD play starts from the first track of the selected disc.

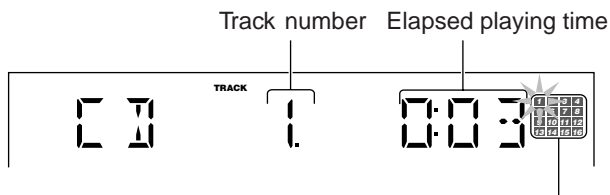
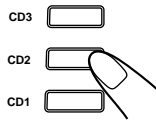

Tracks of the currently playing disc (Track numbers exceeding 16 are not displayed.)

- Pressing CD ►/|| instead of the disc number buttons starts playing back the currently selected CD.
- If no CD is placed on the selected disc tray, “NO DISC 1,” “NO DISC 2,” or “NO DISC 3” appears on the display. Then, the unit continues searching for a CD from the next disc tray.

To stop playing, press ■.

To remove the disc, press ▲ for the corresponding disc tray.



CD playback sequence

When 3 CDs* are loaded on the disc trays, they are played in one of the following sequences.

- When CD1 is pressed: CD1 ⇒ CD2 ⇒ CD3 (then stops)
- When CD2 is pressed: CD2 ⇒ CD3 ⇒ CD1 (then stops)
- When CD3 is pressed: CD3 ⇒ CD1 ⇒ CD2 (then stops)

* When only 2 CDs are loaded, they are played in the same order, but the disc tray without a CD is skipped.

Basic CD Operations

While playing a CD, you can do the following operations.

To exchange CDs during playback of another

Press ▲ corresponding to a CD, not playing or selected currently, to eject and exchange the CD.

If you exchange CDs during play, the current play will not stop until all CDs you have exchanged are played.

To stop play for a moment

Press CD ►/||.

While pausing, the elapsed playing time flashes on the display.

To resume playing, press CD ►/|| again.

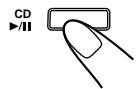

To go to another track

Turn |◀◀ / ▶▶| before or during playback (or press |◀◀ (◀◀) / ▶▶| (▶▶) on the remote control).

- |◀◀ (or |◀◀ (◀◀))): Goes back to the beginning of the current or previous tracks.
- ▶▶| (or ▶▶| (▶▶))): Skips to the beginning of the next or succeeding tracks.

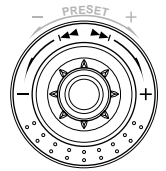

To locate a particular point in a track

During play, press and hold ◀◀ or ▶▶ (or |◀◀ (◀◀) / ▶▶| (▶▶) on the remote control).

- ◀◀ (or |◀◀ (◀◀))): Fast-reverses the disc.
- ▶▶ (or ▶▶| (▶▶))): Fast-forwards the disc.

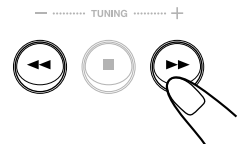

To go to another track directly using the number buttons

On the remote control ONLY:

Pressing the number button(s) before or during play allows you to start playing the track number you want.

Ex.: For track number 5, press 5.

For track number 15, press +10, then 5.

For track number 20, press +10, then 10.

For track number 32, press +10, +10, +10, then 2.

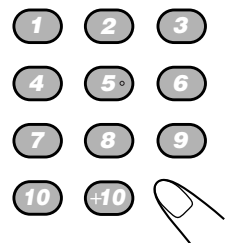

Programming the Playing Order of the Tracks —Program Play

You can arrange the playing order of the tracks before you start playing. **You can program up to 32 tracks.**

- To use Repeat Play (see page 17) for Program Play, press REPEAT after starting Program Play. Only REPEAT 1 and REPEAT ALL can be selected for Program Play.
- There is a time limit in doing the following steps. If the setting is canceled before you finish, start from step **2** again.

1 Load CDs.

- If the current playing source is not the CD player, press CD ►/II, then ■ before going to the next step.

2 Activate the Program Play mode.

On the unit:

Press CD PLAY MODE repeatedly until “CD PROGRAM” appears on the display.



- Each time you press the button, the play mode changes as follows:

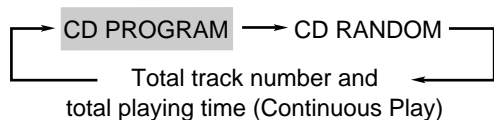

On the remote control:

Press PROGRAM so that “CD PROGRAM” appears on the display.



- If a program has been stored in memory, the program is called up.
- The PRGM (program) indicator also lights up on the display.

3 Press one of the disc number (CD1, CD2, and CD3) buttons to select the disc you want to play.

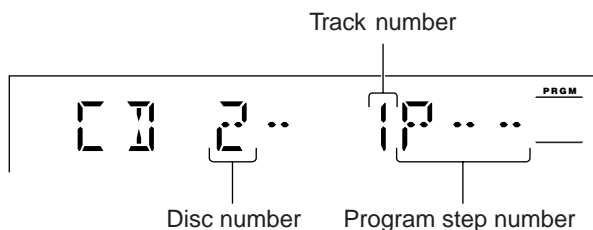
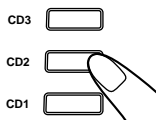

4 Select a track from the selected CD in the above step.

On the unit:

Turn |◀◀ / ▶▶| to select the track number and press SET/DISPLAY.

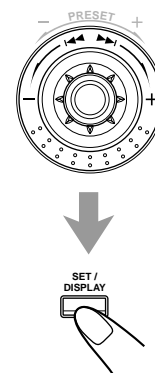

On the remote control:

Press the number buttons.

- For how to use the number buttons, see “To go to another track directly using the number buttons” on page 14.

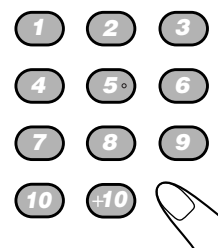

5 Program other tracks you want.

- To program tracks from the same disc, repeat step **4**.
- To program tracks from a different disc, repeat steps **3** and **4**.

6 Press CD ►/II.

The tracks are played in the order you have programmed.



To stop playing, press ■.

To exit from Program Play mode, press CD PLAY MODE repeatedly (or press PROGRAM on the remote control) until the PRGM (program) indicator goes off. The program you have made is stored in memory.



- **If you try to program a 33rd track**
“CD FULL” will appear on the display.
- **If your entry is ignored**
You have tried to program a track from an empty tray, or a track number that does not exist on the CD (for example, selecting track 14 on a CD that has 12 tracks). Such entries are ignored.

To check the program contents

On the remote control ONLY:

Before playing, you can check the program contents by pressing

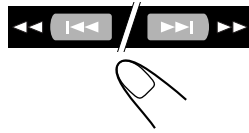

- **◀◀ (◀◀)** : Shows the programmed tracks in the reverse order.
- **▶▶ (▶▶)** : Shows them in the programmed order.

To modify the program

Before or after playing, you can erase the last programmed tracks by pressing CANCEL/DEMO (or press PROGRAM CANCEL on the remote control).

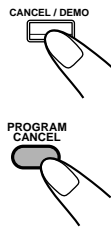

- Each time you press the button, the last programmed track is erased from the program.

To add tracks in the program before playing, simply select the track numbers you want to add by following step 4 of the programming procedure on page 15. If you want to add tracks from another disc, follow steps 3 and 4.

To erase the entire program before or after playing, press and hold ■ until “CD PROGRAM” appears on the display.

- The program you have made will be erased,
 - when you unplug the AC power cord, or
 - when a power failure occurs.

Playing at Random—Random Play

The tracks of all loaded CDs will be played at random.

- To use Repeat Play (see page 17) for Random Play, press REPEAT after starting Random Play. Only REPEAT 1 and REPEAT ALL can be selected for Random Play.

1 Load CDs.

- If the current playing source is not the CD player, press CD ▶/■, then ■ before going to the next step.

2 Activate the Random Play mode.

On the unit:

Press CD PLAY MODE repeatedly until “CD RANDOM” appears on the display.



- Each time you press the button, the play mode changes as follows:

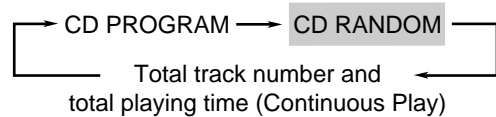

On the remote control:

Press RANDOM so that “CD RANDOM” appears on the display.



- The RANDOM indicator also lights up on the display.

3 Press CD ▶/■.

The tracks are randomly played. Random Play ends when all the tracks are played once.



To skip the currently playing track, turn ◀◀ / ▶▶ to the right (or press ▶▶ (▶▶) on the remote control).



If you turn ◀◀ / ▶▶ to the left (or press ◀◀ (◀◀) on the remote control)

- You cannot go back to the previous tracks during Random Play.
- You can only restart the current playing track.

To stop playing, press ■.

- Random play also stops when one of the disc trays is opened.

To exit from Random Play mode, press CD PLAY MODE (or press RANDOM on the remote control) repeatedly until the RANDOM indicator goes off after playback stops.



Repeating Tracks or CDs—Repeat Play

You can have all the CDs, the program or the individual track currently playing repeat as many times as you like.

To repeat playing, press REPEAT during or before play.

- Each time you press the button, Repeat Play mode changes as follows:

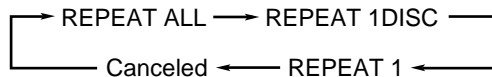

The Repeat Play mode indicator lights up on the display.

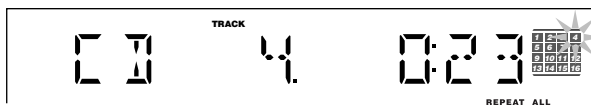

REPEAT ALL: Repeats all the tracks on all the CDs (continuously or at random), or all the tracks in the program.

REPEAT 1DISC: Repeats all the tracks on one CD.

REPEAT 1: Repeats one track on one CD.

To cancel Repeat Play, press REPEAT repeatedly until the Repeat Play mode indicators go off from the display.



“REPEAT 1DISC” is not selected for Program Play and Random Play

It is canceled when you select Program Play or Random Play.

Prohibiting Disc Ejection—Tray Lock

You can prohibit CD ejection from the unit and lock CDs.

- This operation is possible only when the source is the CD player.

On the unit ONLY:

To prohibit disc ejection, press ▲ for any disc tray while holding down ■. (If there is any disc tray opened, close it first.)

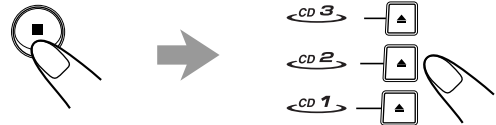

“LOCKED” appears for a while on the display, and the loaded CDs are locked.

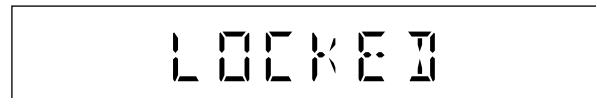

To cancel the prohibition and unlock the CDs, press ▲ for any disc tray while holding down ■.

“UNLOCKED” appears for a while on the display, and the loaded CDs are unlocked.



If you try to eject CDs while Tray Lock is in use “LOCKED” appears to inform you that the disc tray is locked.



Playing Back Tapes

You can play back type I tapes without changing any settings.

Playing Back a Tape

1 Press \blacktriangle EJECT for the cassette deck.

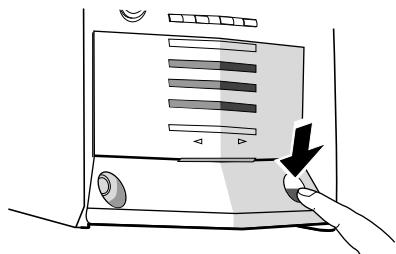

2 Insert a cassette with the exposed part of the tape down.



3 Close the cassette holder gently.

4 Press TAPE $\blacktriangleleft\blacktriangleright$.

The tape play starts and the tape direction indicator (\blacktriangleright or \blacktriangleleft) starts flashing slowly to indicate the tape running direction.

- Each time you press the button, the tape direction changes and “REVERSE” appears for a while on the display.
 - \blacktriangleright : plays the front side.
 - \blacktriangleleft : plays the reverse side.
- If no cassette is inserted, “NO TAPE” appears on the display.

When the tape plays to the end, the deck automatically stops if the Reverse Mode is off. (See “To play both sides repeatedly—Reverse Mode.”)

To stop playing, press \blacksquare .

To fast-wind to the left or to the right, press $\blacktriangleleft\blacktriangleright$ or $\blacktriangleleft\blacktriangleright$ (or $\blacktriangleleft\blacktriangleleft$ ($\blacktriangleleft\blacktriangleleft$) / $\blacktriangleright\blacktriangleright$ ($\blacktriangleright\blacktriangleright$)) on the remote control) while the tape is not running.

The tape direction indicator (\blacktriangleright or \blacktriangleleft) starts flashing quickly on the display.

To remove the cassette, press \blacktriangle EJECT to open the cassette holder.



The use of the C-120 or thinner tape is not recommended, since characteristic deterioration may occur and this tape easily jams in the pinch-rollers and the capstans.

To play both sides repeatedly—Reverse Mode

When using Reverse Mode, the tape automatically reverses at the end of a side and the unit starts playing for the other side of the tape, and repeats the same process.

On the unit ONLY:

To use Reverse Mode, press REVERSE MODE so that the Reverse Mode indicator on the display lights up like— $\blacktriangleleft\blacktriangleright$.

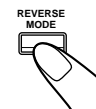

To cancel Reverse Mode, press the button again so that the Reverse Mode indicator on the display lights up like— $\blacktriangleleft\blacktriangleright$.

Locating the Beginning of a Song—Music Scan

You can use Music Scan to locate the beginning of a song. Music Scan searches for blank portions that usually separate recorded songs, then plays the next song.

To find the beginning of the current song

During play, press $\blacktriangleleft\blacktriangleright$ (or $\blacktriangleleft\blacktriangleleft$ ($\blacktriangleleft\blacktriangleleft$) / $\blacktriangleright\blacktriangleright$ ($\blacktriangleright\blacktriangleright$)) on the remote control in the **opposite direction** to the tape play.

The tape direction indicator of the opposite direction to the tape play starts flashing intermittently.

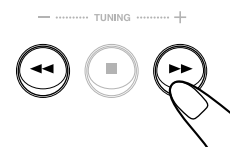

Searching stops automatically at the beginning of the current song, and the current song starts automatically.

To find the beginning of the next song

During play, press $\blacktriangleleft\blacktriangleright$ (or $\blacktriangleleft\blacktriangleleft$ ($\blacktriangleleft\blacktriangleleft$) / $\blacktriangleright\blacktriangleright$ ($\blacktriangleright\blacktriangleright$)) on the remote control in the **same direction** as the tape play.

The tape direction indicator of the same direction as the tape play starts flashing intermittently.

Searching stops automatically at the beginning of the next song, and the next song starts automatically.



Music Scan works by detecting a 4-second long blank between each song, so it will not work well in the following cases

- No blank at the beginning of a song.
- Noise (often caused by much use or poor quality dubbing) which fills the blank.
- Long, very soft passages or pauses in a song.

Recording

IMPORTANT:

- It may be unlawful to record or play back copyrighted material without the consent of the copyright owner.
- The recording level is automatically set correctly, so it is not affected by the VOLUME, the SUBWOOFER LEVEL, and the SOUND MODE controls. Thus, during recording you can adjust the sound you are actually listening to without affecting the recording level.
- If there are excessive noise or static in the recording you have made, the unit may be too close to a TV. Increase the distance between the TV and the unit.
- You can use type I tape for recording.

To protect your recording

Cassettes have two small tabs on the back to protect from unexpected erasure or re-recording.

To protect your recording, remove these tabs.

To re-record on a protected tape, cover the holes with adhesive tape.

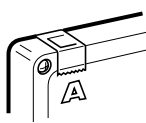

To keep the best recording and playback sound quality

If the heads, capstans, and pinch rollers of the cassette deck become dirty, the following will occur:

- Impaired sound quality
- Discontinuous sound
- Fading
- Incomplete erasure
- Difficulty in recording

To clean the heads, capstans, and pinch rollers

Use a cotton swab moistened with alcohol.

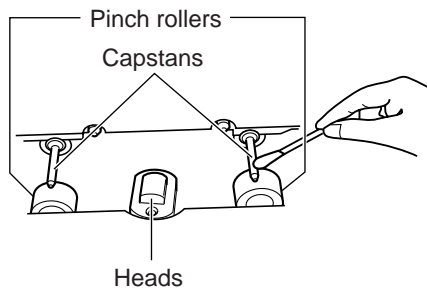

To demagnetize the heads

Turn off the unit, and use a head demagnetizer (available at electronics and audio shops).

Recording on a Tape

- 1 Press **▲ EJECT** to insert a recordable cassette with the exposed part of the tape down.



- 2 Close the cassette holder gently.
 - If you want to record on both sides of a tape, see “To record on both sides—Reverse Mode.”
- 3 Check the tape direction of the cassette deck.
 - If the tape direction is not correct, press TAPE ◀▶ twice then ■ to change the tape direction.
- 4 Start playing the source—FM, AM, CD player, or auxiliary equipment connected to AUX jacks.
 - When the source is a CD, you can also use CD Direct Recording—(see page 20), and Auto Edit Recording—(see page 21).

- 5 Start recording.

On the unit:

Press **REC START/STOP**.

On the remote control:

Press and hold **REC START/STOP** for more than 1 second.

The REC (recording) lamp flashes when recording starts, and the tape direction indicator (▶ or ◀) starts flashing slowly.

- If no cassette is inserted, “NO TAPE” appears on the display. If a protected tape is inserted, “NO REC” appears on the display.

To stop recording immediately, press **REC START/STOP** or ■ (or press and hold **REC START/STOP** on the remote control for more than 1 second).

To remove the cassette, press **▲ EJECT** to open the cassette holder.

To record on both sides—Reverse Mode

On the unit ONLY:

Press **REVERSE MODE** so that the Reverse Mode indicator on the display lights up like—(Z).

- When using the Reverse Mode for recording, start recording in the forward (▶) direction first. Otherwise, recording will stop when recording is done only on one side (reverse) of the tape.

To cancel Reverse Mode, press the button again so that the Reverse Mode indicator on the display lights up like—Z.

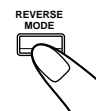

CD Synchronized Recording

By using CD Synchronized Recording methods, you can start and stop a CD play and tape recording at the same time.

CD Synchronized Recording consists of the following:

- CD Direct Recording
- Auto Edit Recording

■ CD Direct Recording

Everything on the CD goes onto the tape in the order it is on the CD, or according to the order you have made for Program Play.

On the unit ONLY:

- 1 Press  EJECT to insert a recordable cassette with the exposed part of the tape down.**



- 2 Load CDs.**

- 3 Press one of the disc number (CD1, CD2, and CD3) buttons to select the disc, then .**

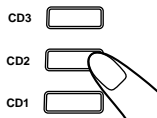

- If you want to make a program, perform steps **2** to **5** on page 15. After making a program, go to the next step.

- 4 Press CD REC START.**

“CD REC” appears on the display and the REC (recording) lamp flashes when recording starts.



The cassette deck starts recording while the CD player starts playing.

When the recording is done, “CD REC FINISHED” scroll through the display, and the REC (recording) lamp goes off. Both the cassette deck and the CD player stop automatically.

To stop recording, press  to create a 4-second blank portion on the recording tape. (Remember, a 4-second blank is important when using Music Scan—see page 18.)





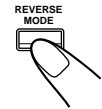

To record on both sides—Reverse Mode

On the unit ONLY:

Press REVERSE MODE so that the Reverse Mode indicator on the display lights up like—.



- When using the Reverse Mode for CD Direct Recording, start recording in the forward () direction first. When the tape reaches its end while recording a song in the forward direction () , the last song will be re-recorded at the beginning of the reverse side () . If you start recording on the reverse side () , recording will stop when recording is done only on one side (reverse) of the tape.

To cancel Reverse Mode, press the button again so that the Reverse Mode indicator on the display lights up like—.



■ Auto Edit Recording

By using Auto Edit Recording, you can record the CD tracks to fit the tape. Auto Edit Recording makes a program by selecting the CD tracks in numerical order. However, to prevent the end of the last track on the front side from being cut off, the last track is selected so to fit the remaining tape length.

On the unit ONLY:

1 Load CDs.

- If the current playing source is not the CD player, press CD ►/■, then ■ before going to the next step.

2 Press EDIT.

MISC ..



3 Press one of the disc number (CD1, CD2, and CD3) buttons to select the disc you want to record from.

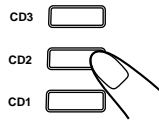

TAPE C ..



TAPE C60

The optimum tape length for the disc appears.

To change the tape length manually

If the tape length selected is not satisfactory, you can change the tape length by turning ◀◀ / ▶▶ on the unit. You can select the tape length among the following —40, 46, 50, 54, 60, 64, 70, 74, 80, 84, and 90.

4 Press SET/DISPLAY.

- Each time you press the button, the tracks to be recorded on the front side (“SIDE-A”) and on the reverse side (“SIDE-B”) appear on the display alternately.

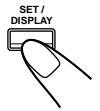

Tracks to be recorded on the reverse side (SIDE-B) appear.

SIDE .. B

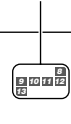

5 Insert a recordable cassette of appropriate length into the cassette deck.

6 Press REVERSE MODE so that the Reverse Mode indicator lights up like (Z).

- Without turning on the Reverse Mode, recording will stop when the front side of the tape is recorded.

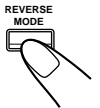

7 Press CD REC START.

“CD REC” appears, then “TAPE SIDE-A STAND-BY” scroll through the display, and the REC (recording) lamp flashes.

The cassette deck starts recording. About 10 seconds later, the CD player starts playing.

When the recording is done, “CD REC FINISHED” scroll through the display and the REC (recording) lamp goes off. Both the cassette deck and CD player stop automatically.

- If a tape has not been rewound, the cassette deck will rewind the tape before it starts recording.
- A 10-second blank portion is automatically created at the beginning of each side of the tape.

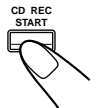

To stop during Auto Edit Recording

Press REC START/STOP or ■ to create a 4-second blank portion on the recording tape. (Remember, a 4-second blank is important when using Music Scan—see page 18.)

To cancel Auto Edit Recording

Press CANCEL/DEMO before or after recording.



Using the Microphones

You can enjoy singing along (Karaoke) and microphone mixing by using two microphones.

- MIC LEVEL adjustment is valid for both microphones connected to MIC 1 and MIC 2 jacks.

IMPORTANT:

- Always set MIC LEVEL to MIN when connecting or disconnecting the microphone.
- When you do not use the microphone, keep the microphones unconnected.

Singing along—Karaoke

■ Vocal Masking

Vocal Masking reduces the lead vocal of the playing source, and allows you to replace it by singing into the microphones as the music plays.

- 1 Turn MIC LEVEL to MIN.



- 2 Connect the microphone(s) (not supplied) by plugging it into MIC 1 and/or MIC 2 jack.

- 3 Press KARAOKE on the remote control.

“KARAOKE” appears for 2 seconds and KARAOKE indicator lights up and remains lit.



- 4 Start playing the source—CD, tape, or other connected component.

- 5 Adjust MIC LEVEL and the volume level as you sing into the microphone(s).

- By pressing REC START/STOP, you can record your singing along if you want. (For more details, see page 19.)

To cancel Vocal Masking, press KARAOKE on the remote control again.

- “OFF” appears for 2 seconds and the KARAOKE indicator goes off. Normal stereo play back resumes.

To apply an echo to your voice

On the remote control ONLY:

Press ECHO so that the ECHO indicator lights up on the display.

- Each time you press the button, the echo level changes as follows:

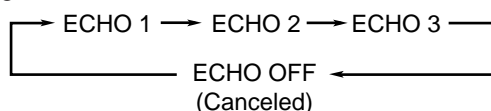
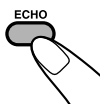

As the number increases, a stronger echo effect applies to your voice.



notes If howling or squealing (feedback) occurs while using the microphone(s)

Take the following actions to prevent these noises.

- Adjust MIC LEVEL and the volume level.
- Avoid pointing the microphone(s) towards the speakers.
- When two microphones are connected, turn off the ON/OFF switch on the unused microphone.



notes If you use the following sources as the playing source for Karaoke (Vocal Masking), you cannot get the satisfactory results

- Radio programs—a radio signal is not as reliable as the signals coming from a tape or CD.
- Monaural sources.
- Poorly dubbed tapes.
- Sources recorded with duets, strong echo, a chorus, or only a few instruments.

■ Microphone Mixing

When you sing along with multiplex tapes or CDs, follow the procedure below:

- 1 Connect the microphone(s).

- 2 Start playing the source—CD, tape, or other connected component.

- 3 Adjust MIC LEVEL and the volume level as you sing into the microphone(s).

- By pressing REC START/STOP, you can record your singing along if you want. (For more details, see page 19.)

To use microphone only

Without any background sound, you can use your microphone(s), and record it if you want.

- 1 Connect the microphone(s).

- 2 Press CD ►/II, then ■.

No background sound will be heard.

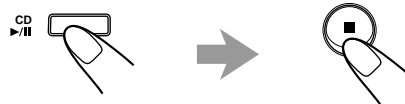

- 3 Adjust MIC LEVEL and the volume level as you sing into the microphone(s).

- By pressing REC START/STOP, you can record your singing along if you want. (For more details, see page 19.)

Using the Timers

There are three timers available—DAILY (Daily Timer), REC (Recording Timer), and SLEEP (Sleep Timer).

Before using the timers, you need to set the clock built in the unit. (See page 9.)

Using Daily Timer

With Daily Timer, you can be awakened with your favorite music or radio program.

You can set the timer whether the unit is on or off; however, if Ecology Mode is activated, you cannot set the clock while the unit is off.

How Daily Timer actually works

The unit automatically turns on, sets the volume level to the preset level, and starts playing the specified source when the on-time comes (“DAILY” and the DAILY (Daily Timer) indicator flash just before the on-time, and the DAILY (Daily Timer) indicator continues flashing while the timer is operating). Then, when the off-time comes (“DAILY OFF” flashes just before the off-time), the unit automatically turns off (on standby).

The Daily Timer works everyday automatically. If you do not want to use the Daily Timer, turn off the Daily timer. (See “To turn on or off Daily Timer after its setting is done” on page 24.) The timer setting remains in memory until you change it.

- There is a time limit in doing the following steps. If the setting is canceled before you finish, start from step 1 again.
- To correct a mis entry while setting the timer, press CANCEL/DEMO.

Before you start...

- *When using a CD as the source to play—*
 - Make sure there is a CD on the selected disc number tray.
- *When using a tape as the source to play—*
 - Make sure that a tape is in the cassette deck.
 - Make sure that the tape direction is correct.
- *When using the external component as the source to play—*
 - Set the timer equipped on the external component at the same time.

On the unit ONLY:

1 Press CLOCK/TIMER repeatedly until “DAILY” appears on the display.

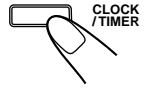

The  (Timer) indicator lights up and the DAILY (Daily Timer) indicator also starts flashing on the display.



- Each time you press the button, the timer setting modes change as follows:

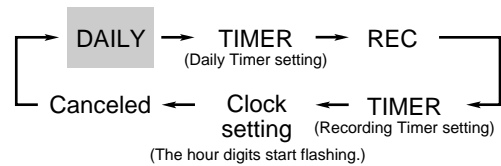



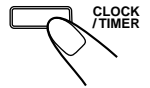

2 Press CLOCK/TIMER again.

“TIMER” appears for 2 seconds, then the unit enters on-time setting mode.



3 Set the on-time you want the unit to turn on at.

- 1) Turn  /  to set the hour, then press SET/DISPLAY.
 - 2) Turn  /  to set the minute, then press SET/DISPLAY.
- “SET” appears for 1 second, then the unit enters off-time setting mode.

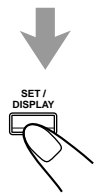
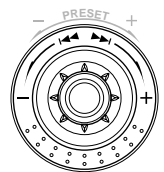

4 Set the off-time you want the unit to turn off (on standby) at.

- 1) Turn **◀◀ / ▶▶** to set the hour, then press SET/DISPLAY.
- 2) Turn **◀◀ / ▶▶** to set the minute, then press SET/DISPLAY.
“SET” appears for 1 second, then the unit enters source selecting mode.

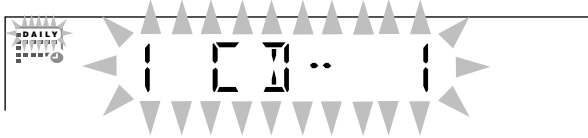

5 Turn **◀◀ / ▶▶** to select the source to play, then press SET/DISPLAY.

“SET” appears for 1 second.

- The source changes as follows:

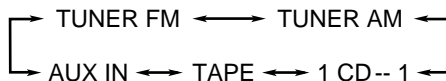

TUNER FM: tunes in to a specified preset FM station.

→ Go to step 6.

TUNER AM: tunes in to a specified preset AM station.

→ Go to step 6.

1 CD-- 1: plays a disc from a specified track of a specified disc. → Go to step 6.

TAPE: plays a tape in the cassette deck.

→ Go to step 7.

AUX IN: plays an external source. → Go to step 7.

6 When selecting “TUNER FM” or “TUNER AM”

Turn **◀◀ / ▶▶** to select the preset station number, then press SET/DISPLAY.

The unit enters volume setting mode.

When selecting “1 CD-- 1”

- 1) Turn **◀◀ / ▶▶** to select the disc number, then press SET/DISPLAY.

“SET” appears for 1 second.

- 2) Turn **◀◀ / ▶▶** to set the track number, then press SET/DISPLAY.

“SET” appears for 1 second, then the unit enters volume setting mode.

7 Turn **◀◀ / ▶▶** to set the volume level.

- The volume level changes as follows:

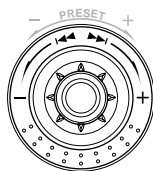
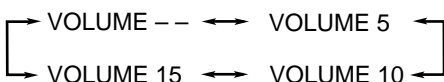

- If you select “VOLUME --,” the volume is set to the last level when the unit has been turned off.

8 Press SET/DISPLAY to complete the Daily Timer setting.

The DAILY (Daily Timer) indicator stops flashing and remains lit. “OK ✓” appears on the display for 2 seconds.

The settings you have done are shown on the display in sequence for your confirmation.

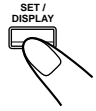

9 Press **⏻/⏺** to turn off the unit (on standby) if you have set the Daily Timer with the unit turned on.

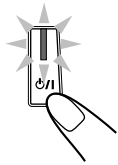

- If the unit is turned on when the on-time comes Daily Timer does not work.
- Even if you unplug the AC power cord or if a power failure occurs

Once you set the timer, the timer setting may remain stored in memory in a few days. In this case, check whether the timer setting still remains or not.

To turn on or off Daily Timer after its setting is done

1 Press CLOCK/TIMER repeatedly until “DAILY” appears on the display.

The **⏻** (Timer) indicator lights up and the DAILY (Daily Timer) indicator starts flashing on the display.

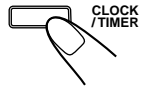

2 To turn off the Daily Timer, press CANCEL/DEMO.

The DAILY (Daily Timer) indicator goes off from the display (“DAILY OFF” appears for a while).

The Daily Timer is canceled, but the setting for the Daily Timer remains in memory.

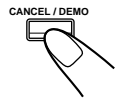

Or

To turn on the Daily Timer, press SET/DISPLAY.

“OK ✓” appears on the display for 2 seconds. The settings you have done are shown on the display in sequence for your confirmation.

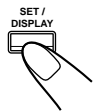

Using Recording Timer

With Recording Timer, you can make a tape of a radio broadcast automatically.

You can set the timer whether the unit is on or off; however, if Ecology Mode is activated, you cannot set the clock while the unit is off.

How Recording Timer actually works

The unit automatically turns on, tunes in to the specified station, sets the volume level to “VOLUME MIN,” and starts recording when the on-time comes (“REC” and the REC (Recording Timer) indicator flash just before the on-time, and the REC (Recording Timer) indicator continues flashing while the timer is operating). Then, when the off-time comes (“REC OFF” flashes just before the off-time), the unit automatically turns off (on standby).

The timer setting remains in memory until you change it.

- There is a time limit in doing the following steps. If the setting is canceled before you finish, start from step **2** again.
- To correct a mis entry while setting the timer, press CANCEL/DEMO.

On the unit ONLY:

1 Insert a recordable cassette with the exposed part of the tape down.

2 Press **CLOCK/TIMER** repeatedly until “REC” appears on the display.

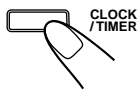

The  (Timer) indicator lights up and the REC (Recording Timer) indicator also starts flashing on the display.

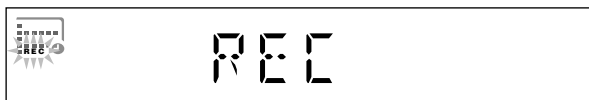

- Each time you press the button, the timer setting modes change as follows:

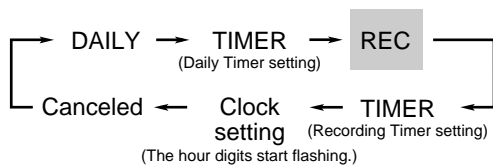

3 Press **CLOCK/TIMER** again.

“TIMER” appears for 2 seconds, then the unit enters on-time setting mode.

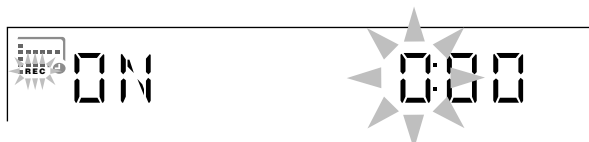
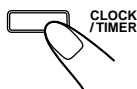

4 Set the on-time you want the unit to turn on at.

- 1) Turn to set the hour, then press SET/DISPLAY.
- 2) Turn to set the minute, then press SET/DISPLAY.

“SET” appears for 1 second, then the unit enters off-time setting mode.

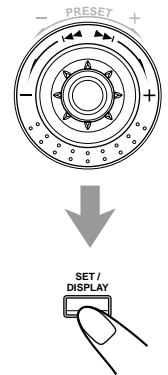

5 Set the off-time you want the unit to turn off (on standby) at.

- 1) Turn to set the hour, then press SET/DISPLAY.
- 2) Turn to set the minute, then press SET/DISPLAY.

“SET” appears for 1 second, then the unit enters preset station selecting mode.

6 Select the preset station.

- 1) Turn to select the band (“TUNER FM” or “TUNER AM”), then press SET/DISPLAY.
- 2) Turn to select a preset channel number, then press SET/DISPLAY.

The REC (Recording Timer) indicator stops flashing and remains lit. “OK ✓” appears on the display for 2 second.

The settings you have done are shown on the display in sequence for your confirmation.

7 Press to turn off the unit (on standby) if necessary.

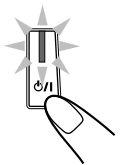

- **If you want to listen to another source while recording**
Press REC START/STOP or to stop recording. Without stopping it, you cannot change the source.
- **Even if you unplug the AC power cord or if a power failure occurs**
Once you set the timer, the timer setting may remain stored in memory for a few days. In this case, check whether the timer setting still remains or not.



To turn on or off Recording Timer after its setting is done

1 Press CLOCK/TIMER repeatedly until "REC" appears on the display.

The  (Timer) indicator lights up and the REC (Recording Timer) indicator starts flashing on the display.

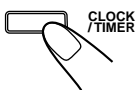

2 To turn off the Recording Timer, press CANCEL/DEMO.

The REC (Recording Timer) indicator goes off from the display ("REC OFF" appears on the display for 2 seconds).

The Recording Timer is canceled, but the setting for the Recording Timer remains in memory.

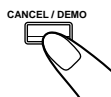

Or

To turn on the Recording Timer, press SET/DISPLAY.

"OK ✓" appears on the display for 2 seconds.

The settings you have done are shown on the display in sequence for your confirmation.

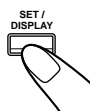

Timer Priority

Since each timer can be set separately, you may wonder what happens if the settings for these timers overlap.

Below are some examples.

Recording Timer has priority over Daily Timer and Sleep Timer.

- If Daily Timer is set to come on while Recording Timer is operating, Daily Timer will not come on at all.

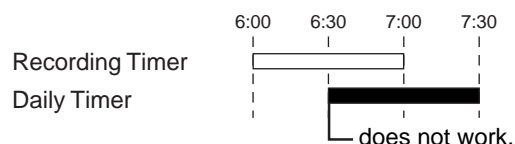

- If Recording Timer is set to come on while Sleep Timer is operating, Sleep Timer will be canceled.



Using Sleep Timer

With Sleep Timer, you can fall asleep to music. You can set Sleep Timer only while the unit is turned on.

How Sleep Timer actually works

The unit automatically turns off after the specified time length passes.

On the remote control ONLY:

1 Press SLEEP.

The time length until the shut-off time appears and the SLEEP indicator starts flashing on the display.

- Each time you press the button, the time length changes as follows:

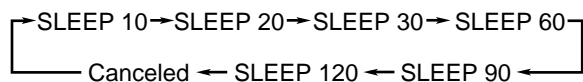

2 Wait for about 5 seconds after specifying the time length.

The SLEEP indicator stops flashing and remains lit.

To check the remaining time until the shut-off time, press SLEEP once so that the remaining time (minute) until the shut-off time appears for about 5 seconds.

To change the shut-off time, press SLEEP repeatedly until the desired time length appears on the display.

To cancel the setting, press SLEEP repeatedly so that the SLEEP indicator goes off.

- Sleep Timer is also canceled when you turn off the unit.

Maintenance



To get the best performance of the unit, keep your discs, tapes, and mechanism clean.

General Notes

In general, you will have the best performance by keeping your CDs and the mechanism clean.

- Store CDs in their cases, and keep them in cabinets or on shelves.
- Keep the system's disc trays closed when not in use.

Handling discs



- Remove the disc from its case by holding it at the edge while pressing the center hole lightly.
- Do not touch the shiny surface of the disc, or bend the disc.
- Put the disc back in its case after use to prevent warping.

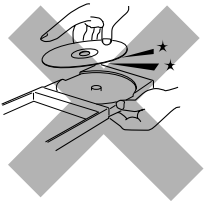

- Be careful not to scratch the surface of the disc when placing it back in its case.
- Avoid exposure to direct sunlight, temperature extremes, and moisture.



To clean the disc

Wipe the disc with a soft cloth in a straight line from center to edge.



DO NOT use any solvent—such as conventional record cleaner, spray, thinner, or benzine—to clean the disc.

Handling cassette tapes

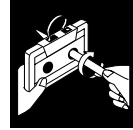

- If the tape is loose in its cassette, take up the slack by inserting a pencil in one of the reels and rotating.
- If the tape is loose, it may get stretched, cut, or caught in the cassette.

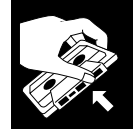

- Be careful not to touch the tape surface.



- Avoid the following places to store the tape:
 - In dusty places
 - In direct sunlight or heat
 - In moist areas
 - Near a magnet

Cleaning the unit

Stains on the unit

Should be wiped off with a soft cloth. If the unit is heavily stained, wipe it with a cloth soaked in water diluted neutral detergent and wrung well, then wipe clean with a dry cloth.

Since the unit may deteriorate in quality, become damaged or get its paint peeled off, be careful about the following.

- DO NOT wipe it with a hard cloth.
- DO NOT wipe it strong.
- DO NOT wipe it with thinner or benzine.
- DO NOT apply any volatile substance such as insecticides to it.
- DO NOT allow any rubber or plastic to remain in contact with it for a long time.

Troubleshooting



If you are having a problem with your unit, check this list for a possible solution before calling for service. If you cannot solve the problem from the hints given here, or the unit has been physically damaged, call a qualified person, such as your dealer, for service.

	Symptom	Cause	Action
GENERAL	Unable to cancel the demonstration.	The button other than CANCEL/DEMO is pressed to cancel the demonstration temporarily.	Press CANCEL/DEMO on the unit. (See page 8.)
	No sound is heard.	Connections are incorrect or loose.	Check all connections and make corrections. (See pages 6 to 8.)
	Operations are disabled.	The built-in microprocessor may malfunction due to external electrical interference.	Unplug the AC power cord and then plug it back in.
	Unable to operate the unit from the remote control.	<ul style="list-style-type: none"> The path between the remote control and the remote sensor on the unit is blocked. The batteries are exhausted. 	<ul style="list-style-type: none"> Remove the obstruction. Replace the batteries.
	Stereo effect is lost.	Vocal Masking is activated.	Cancel the Vocal Masking. (See page 22.)
TUNER	Hard to listen to broadcasts because of noise.	<ul style="list-style-type: none"> Antennas are disconnected. The AM loop antenna is too close to the unit. The FM antenna is not properly extended and positioned. 	<ul style="list-style-type: none"> Reconnect the antennas correctly and securely. Change the position and direction of the AM loop antenna. Extend the FM antenna at the best position.
CD	The disc sound is discontinuous.	The disc is scratched or dirty.	Clean or replace the disc. (See page 27.)
	The disc tray does not open or close.	<ul style="list-style-type: none"> The AC power cord is not plugged in. Trays are locked. 	<ul style="list-style-type: none"> Plug the AC power cord. Unlock the trays. (See page 17.)
	The disc does not play.	The disc is placed upside down.	Place the disc with the label side up.
TAPE	The cassette holders cannot be opened.	Power supply from the AC power cord has been cut off while the tape was running.	Turn on the unit.
REC	Impossible to record.	Small tabs on the back of the cassette are removed.	Cover the holes with adhesive tape. (See page 19.)

Specifications

Design and specifications are subject to change without notice.

Amplifier section

Output Power (IEC 268-3)

SUBWOOFERS: 85 W per channel, min. RMS, both channels driven into 6 Ω at 63 Hz with no more than 0.9% total harmonic distortion.

MAIN SPEAKERS: 22 W per channel, min. RMS, both channels driven into 6 Ω at 1 kHz with no more than 0.9% total harmonic distortion.

Audio input sensitivity/Impedance

(Measured at 1 kHz, with tape recording signal 300 mV)

AUX: 390 mV/50 kΩ

MIX 1/2: 1.5 mV/5 kΩ

Digital output: CD OPTICAL DIGITAL OUTPUT

Signal wave length: 660 nm

Output level: -15 dBm to -12 dBm

Speakers/Impedance:

SUBWOOFERS: 6 Ω - 16 Ω

MAIN SPEAKERS: 6 Ω - 16 Ω

Tuner

FM tuning range: 87.50 MHz - 108.00 MHz

AM tuning range: At 9 kHz intervals: 531 kHz - 1 710 kHz

At 10 kHz intervals: 530 kHz - 1 710 kHz

CD player

CD capacity: 3 CDs

Dynamic range: 85 dB

Signal-to-noise ratio: 90 dB

Wow and flutter: Immeasurable

Cassette deck

Frequency response

Normal (type I): 50 Hz - 14 000 Hz

Wow and flutter: 0.15% (WRMS)

General

Power requirement: AC 110 V / AC 127 V / AC 220 V / AC 230 V - AC 240 V ~ (adjustable with the voltage selector), 50 Hz / 60 Hz

Power consumption: 160 W (in operation)
24 W (on standby with Ecology Mode off)
Less than 3.5 W (on standby with Ecology Mode on)

Dimensions (approx.): 205 mm x 370 mm x 370 mm (W/H/D)

Mass (approx.): 10.0 kg

Supplied accessories

See page 6.

JVC INSTRUCTIONS

SPEAKER SYSTEM SP-HXZ1



MANUAL DE INSTRUCCIONES: SISTEMA DE ALTAVOCES
INSTRUÇÕES: SISTEMA DE ALTIFALANTES

說明書：揚聲器系統

دليل التعليمات: لنظام السماعات

Thank you for purchasing JVC speakers.

Before you begin using them, please read the instructions carefully to be sure you get the best possible performance. If you have any questions, consult your JVC dealer.

Le estamos muy agradecidos por haber adquirido estos altavoces de JVC. Antes de utilizarlos, sírvase leer las instrucciones detenidamente a fin de obtener el mejor rendimiento posible. Si tienenaluna pregunta, acuda a su agente de JVC.

Gratos pela aquisição dos altifalantes JVC.

Antes de desfrutar este sistema, leia atentamente as instruções que o acompanham, de modo a assegurar-se da obtenção do melhor desempenho possível. Caso surjam dúvidas concernentes a este sistema, consulte o seu agente JVC.

感謝您惠購 JVC 揚聲器。

在開始使用之前，請您仔細閱讀本使用說明書，以確保您獲得揚聲器的最佳性能。如有疑問，請與 JVC 代理銷售商聯系。

نشكرك على شراء سماعات جي في سي JVC.

قبل أن تبدأ استعمالها، يرجى قراءة هذه التعليمات بعناية حتى تتأكد من حصولك على أفضل أداء. إذا كان عندك أية أسئلة، عندها راجع موزع JVC لديك.

— SAFETY INSTRUCTIONS —

“SOME DOS AND DON'TS ON THE SAFE USE OF EQUIPMENT”

This equipment has been designed and manufactured to meet international safety standards but, like any electrical equipment, care must be taken if you are to obtain the best results and safety is to be assured.

Do read the operating instructions before you attempt to use the equipment.

Do ensure that all electrical connections (including the mains plug, extension leads and interconnections between pieces of equipment) are properly made and in accordance with the manufacturer's instructions. Switch off and withdraw the mains plug when making or changing connections.

Do consult your dealer if you are ever in doubt about the installation, operation or safety of your equipment.

Do be careful with glass panels or doors on equipment.

DON'T continue to operate the equipment if you are in any doubt about it working normally, or if it is damaged in any way — switch off, withdraw the mains plug and consult your dealer.

DON'T remove any fixed cover as this may expose dangerous voltages.

DON'T leave equipment switched on when it is unattended unless it is specifically stated that it is designed for unattended operation or has a standby mode.

Switch off using the switch on the equipment and make sure that your family know how to do this.

Special arrangements may need to be made for infirm of handicapped people.

DON'T use equipment such as personal stereos or radios so that you are distracted from the requirements of traffic safety. It is illegal to watch television whilst driving.

DON'T listen to headphones at high volume as such use can permanently damage your hearing.

DON'T obstruct the ventilation of the equipment, for example with curtains or soft furnishing.

Overheating will cause damage and shorten the life of the equipment.

DON'T use makeshift stands and NEVER fix legs with wood screws — to ensure complete safety always fit the manufacturer's approved stand or legs with the fixings provided according to the instructions.

DON'T allow electrical equipment to be exposed to rain or moisture.

ABOVE ALL

- NEVER let anyone, especially children, push anything into holes, slots or any other opening in the case.
- this could result in a fatal electrical shock;
- NEVER guess or take chances with electrical equipment of any kind
- it is better to be safe than sorry!

Connection

Conexión

Ligaçao

接線

التوصيل

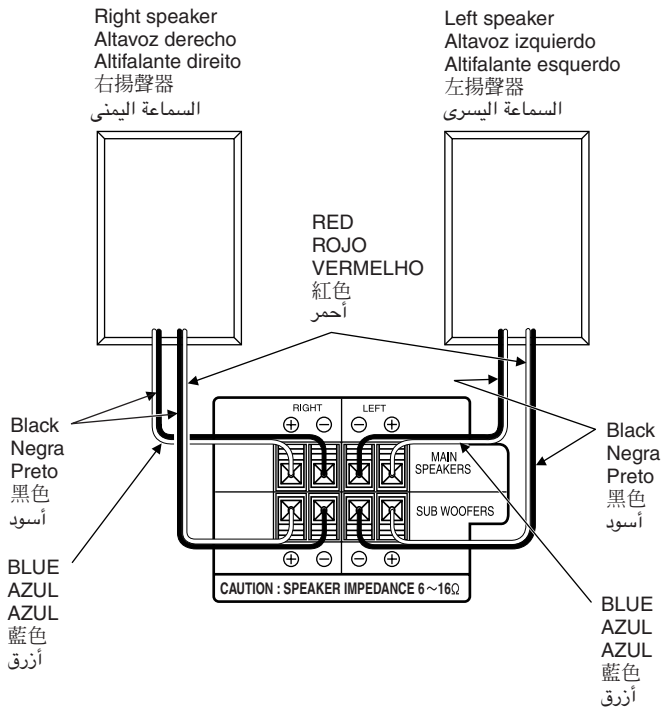

Amplifier output terminals
Terminales de salida de amplificador
Terminais de saida do amplificador
放大器輸出端子
نهايات خرج المضخم

CONNECTION

- DON'T use other amplifier to operate this speaker system except for CA-HXZ1.
- Turn off power to the whole system before connecting the speakers to the amplifier.
- The maximum power handling capacity of the SP-HXZ1 main speaker is 55 W/Subwoofer is 130 W. Excessive input will result in abnormal noise and possible damage. In cases where the signals described below are applied to the speakers, even if the signals are below the maximum allowable input, they may cause an overload and burn the wiring of the speakers. Be sure to lower the amplifier volume beforehand.
 - 1) Noise during FM tuning.
 - 2) High level signals containing high frequency components produced by a tape deck in the fast forward mode.
 - 3) Click noise produced when turning power of other components on and off.
 - 4) Click noise produced when connecting or disconnecting cords with the power on.
 - 5) Click noise produced when the cartridge is replaced with the power on.
 - 6) Click noise produced when operating amplifier switches.
 - 7) Continuous high frequency oscillation or high pitch electronically produced musical instrument sound.
 - 8) Howling when using a microphones.

CAUTION

Do not drag or push the speakers on the floor or table. Otherwise, the four feet at the bottom side of each speaker may peel off or drop from the speaker.

SPECIFICATIONS

Type	: 3-way 4-speaker Bass-Reflex Type Twin Hyper Power-Drive Subwoofers and Front Twin Woofer
Speakers	
Subwoofer	: 16.0 cm (6-5/16 in.) cone × 1
Main woofer	: 10.0 cm (3-15/16 in.) cone × 2
Tweeter	: 5.0 cm (2 in.) cone × 1
Power Handling Capacity	
Subwoofer	: 130 W
Main Speaker	: 55 W
Impedance	
Subwoofer	: 6 Ω
Main Speaker	: 6 Ω
Frequency Range	
Subwoofer	: 30 Hz — 120 Hz
Main Speaker	: 75 Hz — 32 000 Hz
Sound Pressure Level	
Subwoofer	: 78 dB/W·m
Main Speaker	: 86 dB/W·m
Dimensions (W × H × D)	: 217 mm × 432 mm × 365 mm (8-9/16 in. × 17-1/16 in. × 14-3/8 in.)
Mass	: 7.6 kg (16.8 lbs) each

Design and specifications subject to change without notice.

CONEXIÓN

- NO utilice ningún otro amplificador para operar este sistema de altavoces excepto CA-HXZ1.
- Desactive la alimentación de todo el sistema antes de conectar los altavoces al amplificador.
- La capacidad máxima de potencia del altavoz principal del SP-HXZ1 es de 55 W y la del altavoz de subgraves es de 130 W. En casos donde las señales descritas más abajo se apliquen a los altavoces, aunque las mismas resulten menores que la entrada máxima permisible, pueden causar una sobrecarga y quemar el cableado de los altavoces. Asegúrese de disminuir el volumen del amplificador con anterioridad.
 - 1) Ruido durante la sintonía en FM.
 - 2) Señales de alto nivel que contengan componentes de alta frecuencia producidos por un magnetófono en el modo de avance rápido.
 - 3) Ruidos de conmutación provocados al encender y apagar otros componentes.
 - 4) Ruido de conmutación al conectar o desconectar cables con los componentes encendidos.
 - 5) Ruido de conmutación cuando se reemplaza la cápsula con los componentes encendidos.
 - 6) Ruido de conmutación provocados por la operación de los selectores del amplificador.
 - 7) Continua oscilación de alta frecuencia o de sonidos de tonos altos provocados por instrumentos electrónicos.
 - 8) Aullidos al utilizar micrófonos.

Precaución

No arrastre ni empuje los altavoces sobre el piso o la mesa. De lo contrario, las cuatro patas del lado inferior de cada altavoz se podrían desprender o salir del altavoz.

ESPECIFICACIONES

Tipo	: Reflex bajo con 4-altavoces y 3 vías Twin Hyper Power-Drive Subwoofers and Front Twin Woofer
Altavoces	
De subgraves	: Tipo cónico de 16,0 cm × 1
Principal	: Tipo cónico de 10,0 cm × 2
De agudos	: Tipo cónico de 5,0 cm × 1
Capacidad de potencia	
De subgraves	: 130 W
Principal	: 55 W
Impedancia	
De subgraves	: 6 Ω
Principal	: 6 Ω
Gama de frecuencias	
De subgraves	: 30 Hz — 120 Hz
Principal	: 75 Hz — 32 000 Hz
Nivel de presión acústica	
De subgraves	: 78 dB/W·m
Principal	: 86 dB/W·m
Dimensiones (An × Al × Prf)	: 217 mm × 432 mm × 365 mm
Peso	: 7,6 kg cada uno

El diseño y las especificaciones están sujetos a cambio sin previo aviso.

LIGAÇÃO

- NÃO use outro amplificador para operar este sistema de altifalantes à excepção do CA-HXZ1.
- Desligue a alimentação de todo o sistema antes de iniciar as ligações dos altifalantes ao amplificador.
- A potência efectiva máxima do altifalante principal do SP-HXZ1 é de 55 W; a do subwoofer é de 130 W. Uma entrada excessiva resultará em ruídos anormais e possíveis avarias. Nos casos em que os sinais descritos abaixo apresentem-se nos altifalantes, mesmo que os sinais estejam abaixo do nível de entrada permissível, poderão causar uma sobrecarga e o curto-circuito dos fios dos altifalantes. Certifique-se de reduzir o volume do amplificador de antemão.
 - 1) Interferências durante a sintonia de FM.
 - 2) Sinais com níveis elevados e com componentes de alta frequência produzidos pelo deck de cassetes durante o modo do avanço rápido.
 - 3) Estalidos produzidos quando do ligar/desligar da alimentação de outros componentes.
 - 4) Estalidos produzidos ao se ligar/desligar cabos de ligação com a alimentação ligada.
 - 5) Estalidos produzidos quando da troca da célula fonocaptadora com a alimentação ligada.
 - 6) Estalidos produzidos quando do activar/desactivar dos interruptores do amplificador.
 - 7) Oscilação contínua das altas frequências ou altas tonalidades electronicamente produzidas por sons de músicas instrumentais.
 - 8) Efeito de realimentação acústica (microfonia) quando da utilização de microfone.

Precaução

Não arraste nem empurre as caixas acústicas no chão ou na mesa, do contrário os quatro pés da parte inferior de cada uma delas podem se desprender ou cair.

ESPECIFICAÇÕES

Tipo	: Reflector de graves de 3 vías e 4 altifalantes Twin Hyper Power-Drive Subwoofers and Front Twin Woofer
Altifalantes	
Subwoofer	: Cónico de 16,0 cm × 1
Woofer principal	: Cónico de 10,0 cm × 2
Tweeter	: Cónico de 5,0 cm × 1
Potência efectiva	
Subwoofer	: 130 W
Altifalante principal	: 55 W
Impedância	
Subwoofer	: 6 Ω
Altifalante principal	: 6 Ω
Amplitude de frequência	
Subwoofer	: 30 Hz — 120 Hz
Altifalante principal	: 75 Hz — 32 000 Hz
Nível da pressão sonora	
Subwoofer	: 78 dB/W·m
Altifalante principal	: 86 dB/W·m
Dimensões (larg. × alt. × prof.)	: 217 mm × 432 mm × 365 mm
Peso	: 7,6 kg cada

Desenho e especificações sob reserva de alterações sem aviso prévio.

接線

- 請勿使用其他放大器操作 CA-HXZ1 以外的揚聲器系統。
- 要將揚聲器連接到放大器時，須關掉全裝置系統的電源。
- SP-HXZ1 主揚聲器的最大功率儲備容量為 55 W (瓦)，副低音喇叭的為 130 W (瓦)。過大的輸入，將造成異常噪聲，甚至損壞揚聲器。當下列信號輸入揚聲器時，即使該信號低於最大容許輸入，仍有可能造成過載而燒毀揚聲器導線，故請預先調低放大器的音量控制，以策安全。
 - 在 FM 調諧中產生的噪聲。
 - 磁帶錄音機的快進模式中產生的含有高頻成分的高電平信號。
 - 開關其它組成部分電源時產生的卡嗒噪聲。
 - 接通著電源進行接線或斷線時產生的卡嗒噪聲。
 - 接通著電源更換卡盤時產生的卡嗒噪聲。
 - 操作放大器開關時產生的卡嗒噪聲。
 - 連續的高頻率振蕩或高音調電子裝置產生的樂器聲。
 - 使用麥克風時發生的嘯聲。

小心

切勿拖拉放在地板或桌面上的揚聲器。
否則，各揚聲器底部的四個支腳可能會剝離或脫落。

規格

類型	: 3 通道 4 揚聲器低音反射型 Twin Hyper Power-Drive Subwoofers and Front Twin Woofer
揚聲器	
副低音喇叭	: 錐型 16.0 cm × 1
主喇叭	: 錐型 10.0 cm × 2
高音喇叭	: 錐型 5.0 cm × 1
最大功率	
副低音喇叭	: 130 W (瓦)
主揚聲器	: 55 W (瓦)
阻抗	
副低音喇叭	: 6 Ω (歐姆)
主揚聲器	: 6 Ω (歐姆)
頻率範圍	
副低音喇叭	: 30 Hz — 120 Hz
主揚聲器	: 75 Hz — 32 000 Hz
聲壓級	
副低音喇叭	: 78 dB/W · m
主揚聲器	: 86 dB/W · m
尺寸 (W×H×D)	: 217 mm × 432 mm × 365 mm
質量	: 每個 7.6 kg

設計與規格如有變更，恕不另行通知。

التوصيل

- لا تستعمل مضخم صوت آخر لتشغيل نظام السماعات هذا باستثناء للموديل CA-HXZ1.
- افصل الطاقة لكل النظام قبل توصيل السماعات بالمضخم.
- أقصى سعة للقدرة لتشغيل السماعة الرئيسية لنظام السماعات SP-HXZ1 هي 55 واط وللمجهر الفرعي الترددات المنخفضة هي 130 واط. الدخل الزائد سيؤدي الى تشويش شاذ وامكانية حدوث تلف. في الحالات التي تنطبق فيها الاشارات الموصوفة أدناه على السماعات، حتى لو كانت الاشارات دون أقصى دخل مسموح به، فانها قد تسبب حملاً زائداً وحرق اسلاك السماعات. لهذا تأكد من تخفيض جهارة صوت المضخم مقدماً.
 - تشويش أثناء موافقة البث FM.
 - اشارات ذات مستوى مرتفع تحوي مركبات تردد عال ناتجة عن جهاز كاسيت في وضع التقديم السريع.
 - صوت طقطقة ينتج عند تشغيل وايقاف الطاقة على الاجهزة الاخرى.
 - صوت طقطقة ينتج عند وصل أو فصل الاسلاك بينما تكون الطاقة موصلة.
 - صوت طقطقة ينتج عند استقبال الكارتريج بينما تكون الطاقة موصلة.
 - صوت طقطقة ينتج عند تشغيل مفاتيح المضخم.
 - ذبذبة مستمرة ذات تردد مرتفع أو نغمة عالية ناتجة الكترونياً عن صوت آلة موسيقية.
 - زعيق عند استخدام ميكروفون.

تنبيه

لا تعتمد الى جر أو دفع السماعات على الأرضية أو على طاولة.
إذا فعلت ذلك فقد تنفلت الأقدام الأربعة الموجودة على الجهة الجانبية لقاء ك سماعة أو تسقط من موضعها على السماعة.

المواصفات

النوع	: ثلاثي التكوين 4 سماعات من النوع العاكس Twin Hyper Power-Drive Subwoofers and Front Twin Woofer
السماعات	
المجهر الفرعي للترددات المنخفضة	: نوع مخروطي 16.0 سم × 1
المجهر الرئيسي للترددات المنخفضة	: نوع مخروطي 10.0 سم × 2
مجهر الترددات العالية	: نوع مخروطي 5.0 سم × 1
سعة تشغيل القدرة	
المجهر الفرعي للترددات المنخفضة	: 130 واط
السماعة الرئيسية	: 55 واط
المقاومة	
المجهر الفرعي	: 6 أوم
السماعة الرئيسية	: 6 أوم
مجال الترددات	
المجهر الفرعي	: 30 - 120 هرتز
السماعة الرئيسية	: 75 - 32000 هرتز
مستوى ضغط الصوت	
المجهر الفرعي	: 78 ديسيبل/واط-متر
السماعة الرئيسية	: 86 ديسيبل/واط-متر
الابعاد	
الوزن	: 217 مم × 432 مم × 365 مم 7.6 كجم لكل وحدة

التصميم والمواصفات عرضة للتغيير دون إشعار.

JVC

VICTOR COMPANY OF JAPAN, LIMITED