



15D1 Touchcomputer User Guide

15D1 15-inch LCD Multi-function Touchcomputer

[Model 15D1]



Our commitment. Your advantage.

Elo TouchSystems

15D1 Touchcomputer User Guide

15-inch Multi-function Touchcomputer

Revision A

P/N E674343

Elo TouchSystems

1-800-ELO TOUCH (1-800-356-8682)
www.elotouch.com

Copyright © 2009 Tyco Electronics. All Rights Reserved.

No part of this publication may be reproduced, transmitted, transcribed, stored in a retrieval system, or translated into any language or computer language, in any form or by any means, including, but not limited to, electronic, magnetic, optical, chemical, manual, or otherwise without prior written permission of Elo TouchSystems.

Disclaimer

The information in this document is subject to change without notice. Elo TouchSystems makes no representations or warranties with respect to the contents hereof, and specifically disclaims any implied warranties of merchantability or fitness for a particular purpose. References in this publication to Elo TouchSystems products or services do not imply that Elo TouchSystems intends to make them available in all countries in which Elo TouchSystems operates. Elo TouchSystems reserves the right to revise this publication and to make changes from time to time in the content hereof without obligation of Elo TouchSystems to notify any person of such revisions or changes.

Trademark Acknowledgments

Elo TouchSystems, IntelliTouch, SecureTouch, AccuTouch, MonitorMouse, TE logo, and Tyco Electronics are trademarks. Other product names mentioned herein may be trademarks or registered trademarks of their respective companies. Tyco Electronics claims no interest in trademarks other than its own.

Table of Contents

Chapter 1: Setup	1
Unpacking Your Touchcomputer	1
Adjusting the Display	2
Setting Up the Operating System.....	2
Testing Peripherals.....	5
Calibrating the Touchscreen	5
Securing the Base.....	7
Advertising Brackets.....	7
Chapter 2: Operation	9
On-Screen Display (OSD)	10
LED Functionality	11
Using the Input/Output Panel.....	13
Chapter 3: Options and Upgrades	16
Adding Optional Peripherals.....	16
Magnetic Stripe Reader (MSR)	17
Customer Display.....	19
Fingerprint Reader (FPR)	21
Barcode Scanner	22
Third-Party Peripherals.....	27
Chapter 4: Safety and Maintenance	29
Safety	29
Care and Handling	30
Recovering the Operating System	31
Chapter 5: Technical Specifications	32
Touchcomputer Specifications.....	32
Connector Specifications	35
Cash Drawer Port Specifications	36
Display Screen Specifications.....	37
Environmental Specifications	38

Chapter 6: Technical Support	39
Technical Assistance.....	39
Regulatory Information	41
Warranty	44
Index	46

This chapter discusses how to set up and test your touchcomputer. For information on peripheral options, refer to Chapter 3, “Options and Upgrades.”

Unpacking Your Touchcomputer

Check that the following items are present and in good condition:



Touchcomputer

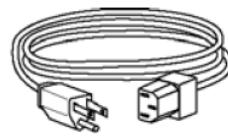

Power cable US/Canada

← AND →

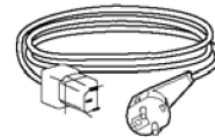

Power cable Europe



Recovery DVD and Quick Install Guide



Advertising brackets



Optional security screw

Adjusting the Display

The display screen can be adjusted from 0 to 60 degrees, as shown below.

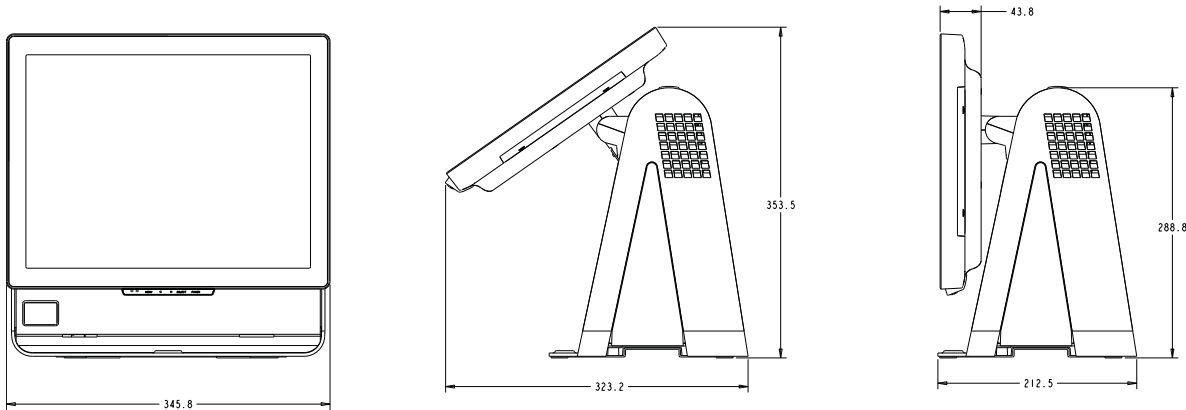

CAUTION: To protect the LCD, be sure to hold the base when adjusting the display, and take care to not touch the screen.

Setting Up the Operating System

The initial setup of the operating system takes approximately 5-10 minutes. Additional time might be needed for different touchcomputer hardware configurations and connected devices.

To set up the Windows OS for the touchcomputer, turn on the touchcomputer by pressing the power button, and then follow the instructions on the screen.

Selecting the Language

Windows uses English as the default language in menus and dialog boxes. You can change this language to suit your preferences. Follow these steps:

1. From the desktop, click **Start > Settings > Control Panel** (in Windows XP) or **Start > Control Panel** (in Vista).
2. In the Control Panel screen, select **Regional and Language Options**.

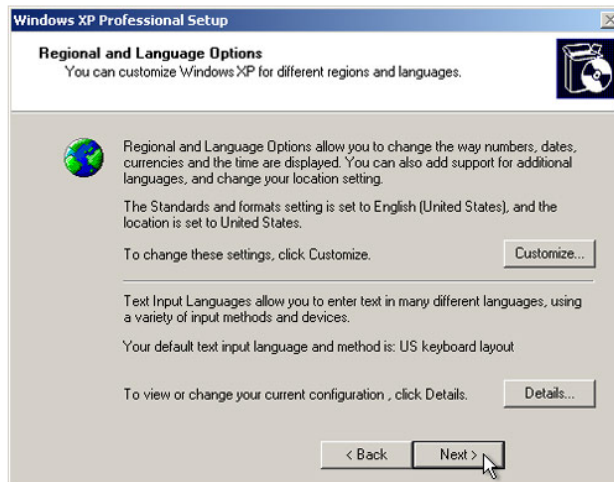

3. Click **Customize**. The Regional and Language Options window appears. Select the **Languages** tab.

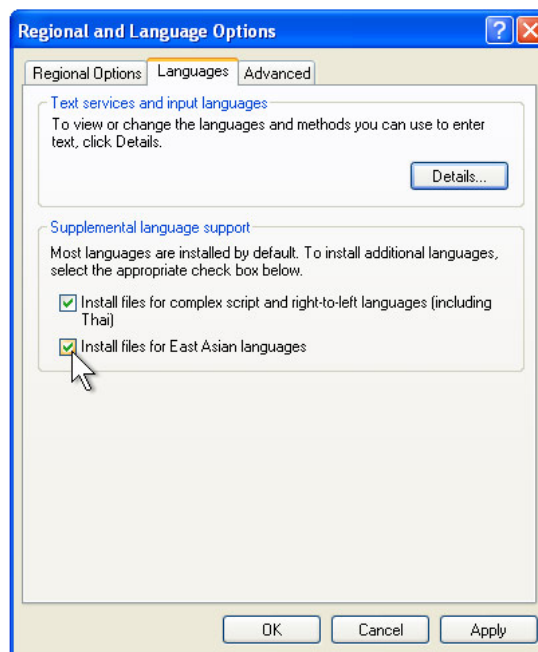

4. If required, check the boxes for “Install files for complex script and right-to-left languages” and “Install files for East Asian languages.”
5. Select the **Regional Options** tab.
6. Select your preferred language from the drop-down list in the Standards and formats pane.

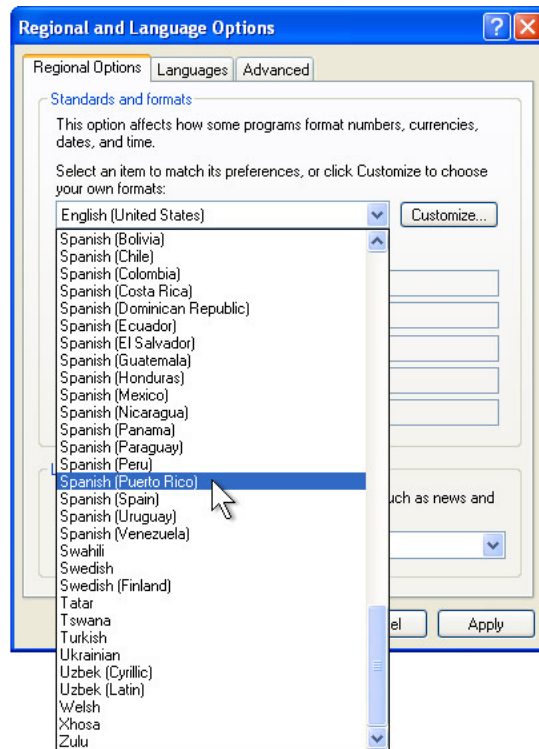

7. Click **Apply**.
8. Select your location from the drop-down list in the Locations pane.

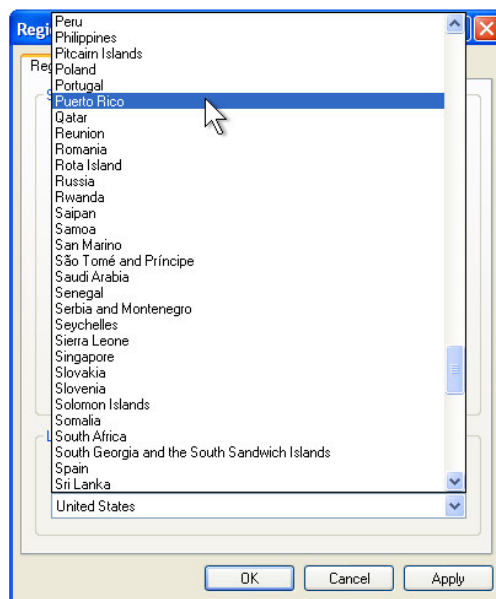

9. Click **OK**.

Selecting the Time Zone

When the following window appears, you can change the time zone, date, and time of the touchcomputer.

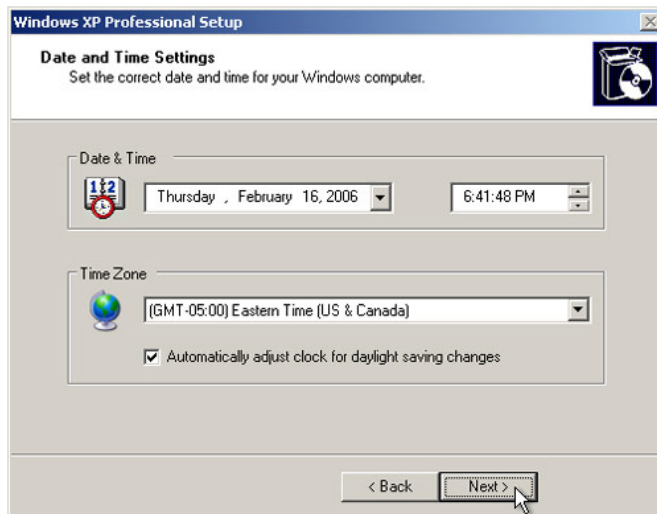

After making any changes, click **Next** to finish. Windows Setup completes the installation of the touchcomputer.

Testing Peripherals

The touchcomputer can be configured with several different optional peripherals, such as a MSR or cash drawer. To test an optional peripheral that is installed on the touchcomputer, refer to the instructions in Chapter 3, “Options and Upgrades.”

NOTE: *Testing icons are located on the desktop. Testing a particular peripheral can only be done after the device is properly installed.*

Calibrating the Touchscreen

The touchscreen is pre-calibrated for accurate touch response.

If for any reason the touchscreen needs to be recalibrated, right-click the Elo icon in the Task bar and then click “Properties.” The following window opens.

NOTE: *Calibration is not applicable to APR models.*



Click the **Align** button. This launches the calibration program. The window shown below opens. Follow the instructions to calibrate the touchscreen.

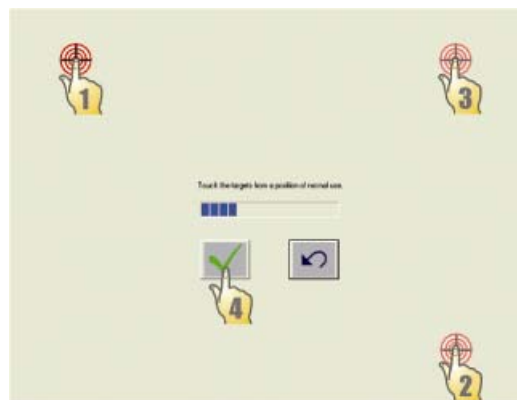

Securing the Base

There are two mounting options for the 15D1 touchcomputer. In both cases, the base must be mounted on a horizontal surface.

- **Option 1: Secure from below.** Use the four pretapped holes to secure the touchcomputer from below the mounting surface. The holes are designed to work with ISO metric m6 screws. These screws are not contained in the package, but should be readily available at any hardware store.
- **Option 2: Secure from top.** Use the two through holes to secure the base to the surface.

NOTE: *Mounting screws are not provided with the shipment.*

Refer to the figure below for the location of the holes. All dimensions are in millimeters.

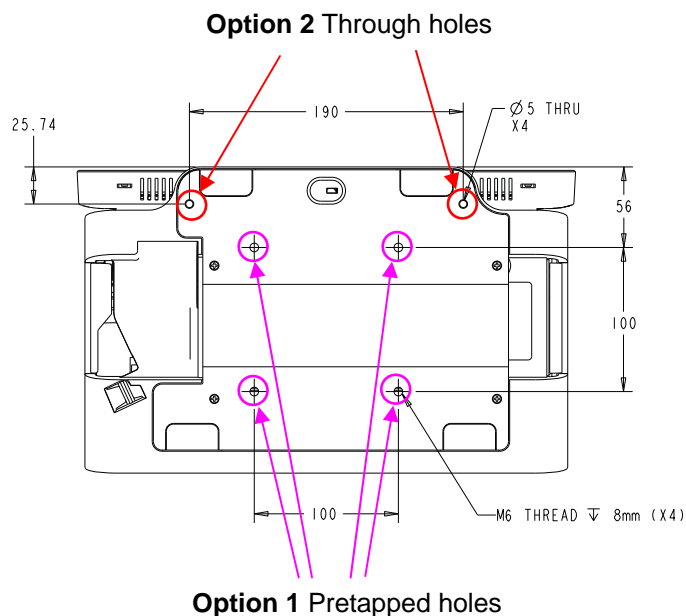

Advertising Brackets

Advertising brackets are provided to allow the user to display paper ads on the back of the 15D1 touchcomputer. These brackets are included separately in the accessory box. The maximum size of the advertising material is 220mm X 320mm (8.6" X 12.6").

To install these brackets, simply push them onto the sides of the back door of the 15D1 touchcomputer, as shown in the figure below.



Then insert the advertising material as shown below.



OPERATION

This chapter describes how to control the On-Screen Display (OSD), power buttons, and I/O panel.

All adjustments made to the OSD and power controls are automatically saved. User settings remain unchanged after powering off/on or in the case of a power failure.

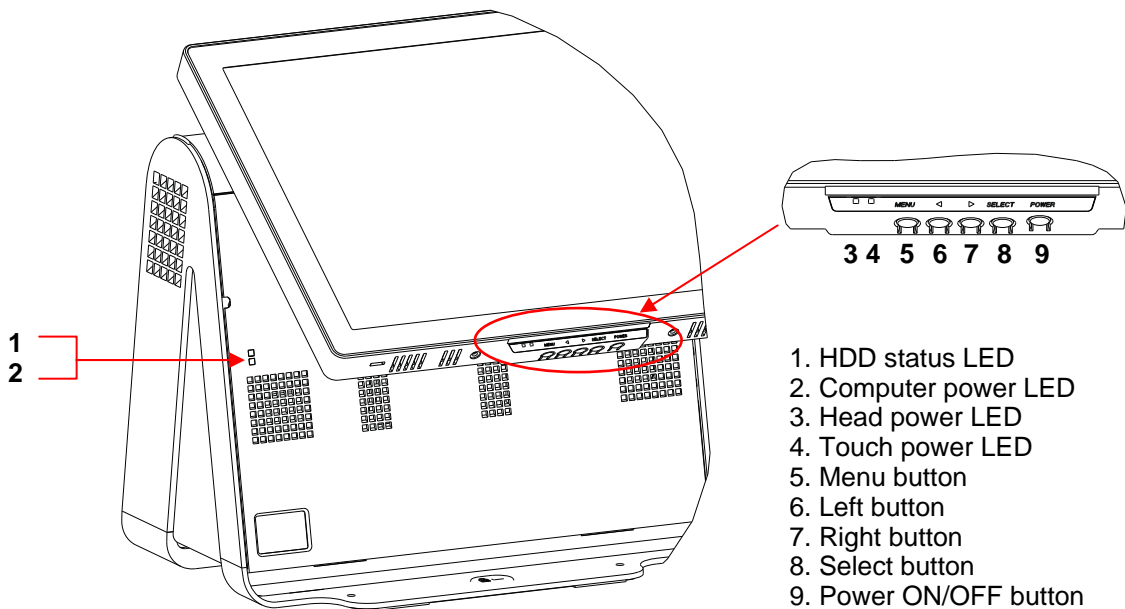

On-Screen Display (OSD)

OSD Menu

1. To display the OSD Menu, press the Menu button.

Press the RIGHT button or LEFT button to toggle and the SELECT button to select from the different OSD sub-menus and functions.

2. When the function you want to change is shown, press the SELECT button.
3. To adjust the value of the function:
4. Pressing the RIGHT button increases the value of the selected OSD control option.
5. Pressing the LEFT button decreases the value of the selected OSD control option.

The OSD provides the following settings.

Feature	Description
Auto adjust	Automatically adjusts system clock.
Brightness	Adjust brightness and contrast. <ul style="list-style-type: none">• Brightness: Adjusts the backlight of the monitor.• Contrast: Adjusts the maximum luminance level of the monitor.
Image setting	Adjusts H position, V position, clock, and phase. <ul style="list-style-type: none">• H position: Moves the screen horizontally right and left (1 pixel pitch increment).• V position: Moves the screen vertically up and down (1 line increment).• Clock: Adjusts the ratio of dividing frequency of the dot clock.• Phase: Adjusts the phase of the dot clock.
Color	Sets color temperature (9300K, 7500K, 6500K, 5500K, or User Preset).
OSD	Adjusts H position, V position, and OSD timeout. <ul style="list-style-type: none">• H position: Adjusts the OSD menu screen position left or right.• V position: Adjusts the OSD menu screen position up or down.• Timeout: Adjusts the amount of time that the OSD menu is displayed.

Feature	Description
Language	Changes language to English, French, Italian, German, Spanish, Japanese, Simplified Chinese, or Traditional Chinese.
Recall	Sets color recall and recall defaults. Restores original factory settings.
Miscellaneous	Adjusts sharpness, enables/disables DDCCI function. <ul style="list-style-type: none"> Sharpness: Adjusts sharpness of video.
Exit	Exits the OSD.

OSD and Power Button Control

The OSD menu and power button are enabled by default.

To enable or disable the OSD function:

1. Simultaneously press **Menu/Exit** and the Left (<-) key for two seconds. A window appears displaying **OSD ENABLE** or **OSD DISABLE**.
2. When the OSD is disabled, the OSD menu is not visible.

To enable or disable the power button (PWR) lock function:

1. Simultaneously press **Menu/Exit** and the Right (->) key for two seconds. A window appears displaying **PWR ENABLE** or **PWR DISABLE**.
2. When the power button lock feature is activated, the power button is disabled.

LED Functionality

Base Power Status LED

The 15D1 base has two LEDs that indicate the power status and hard drive status. See the figure on page 9, item 1 for the location of this LED. The light can be green, flashing green, red, or off. The table below shows LED state and corresponding color.

LED Color to Observer	State
Off	No input power — Off mode
Red	Input power present, power switch off — Off mode
Flashes green	Input power present — Sleep mode
Green	Input power present — On mode

Head Power Status LED

The head power status is indicated by a different LED, which is located at the lower edge of the head (#3 in figure on page 9).

LED Color to Observer	State
Off	No input power to head — Off mode
Red	Input power present, power switch off — Off mode
Amber	Input power present — Sleep mode
Green	Input power present — On mode

Touch Power Status LED

The touch power status is indicated by a separate LED located at the lower edge of the head and to the right of the Head Power Status LED (#4 in figure on page 9). This feature is available for AT and APR 7010.

LED Color to Observer	State
Off	No input power — Off mode
Red	Input power present, power switch off — Off mode
Amber	Input power present — Sleep mode
Green	Input power present — On mode

HDD Activity LED

Hard disk drive activity is indicated by a flashing LED on the base, just under the computer power LED (#2 in the figure on page 9). Reading from and writing to the disk causes the LED to flash.

LED Color to Observer	State
Off	No activity
Flashes green	Activity

Using the Input/Output Panel

To access the input/output (I/O) ports, open the cable cover door on the left side of the unit, as shown below.

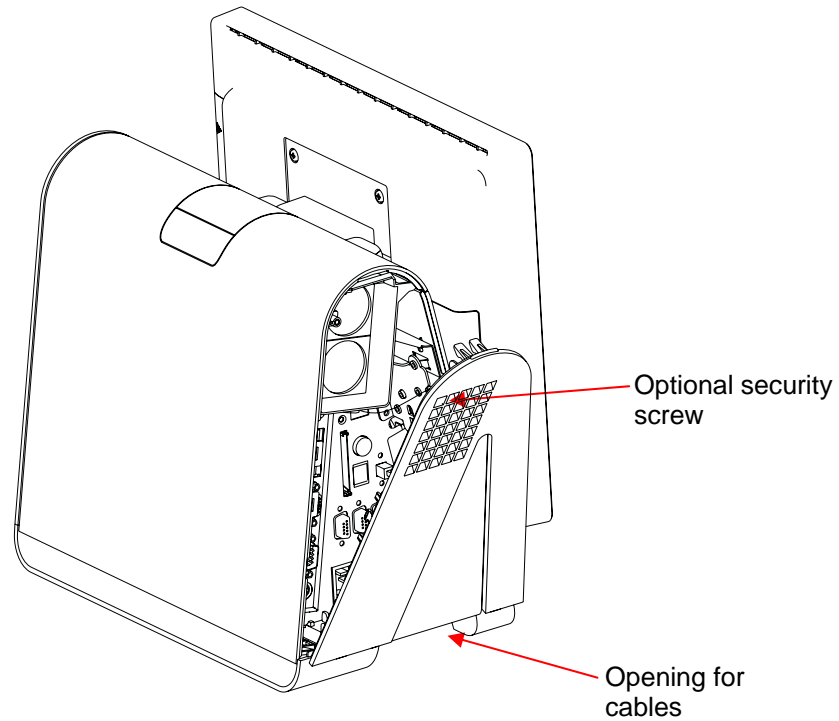

The touchcomputer provides a number of input and output interfaces for connecting a wide variety of compliant devices as shown in the following figure.

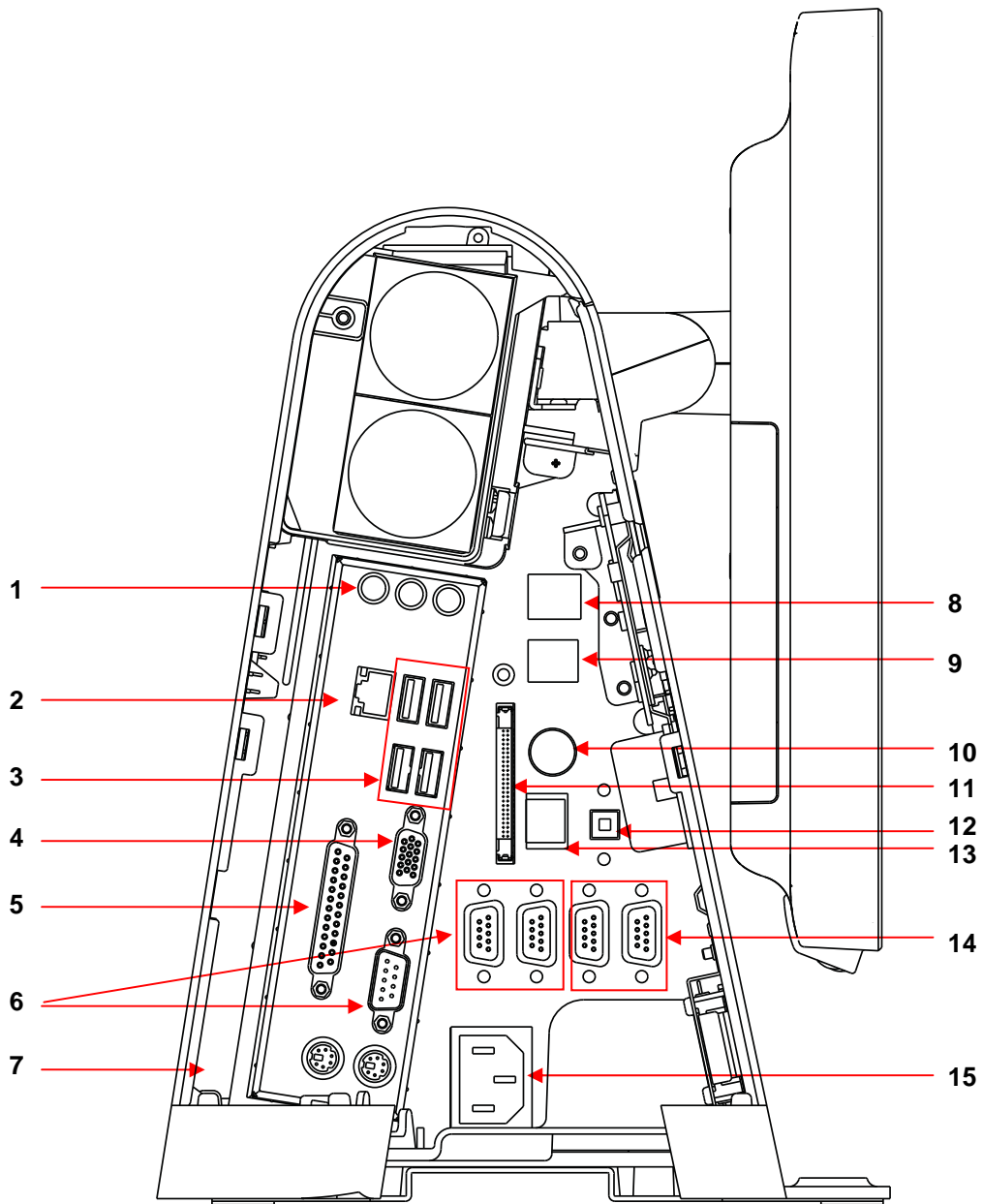

Number	Port	Description
1	Audio	Audio in (left), out (center), mic (right) <ul style="list-style-type: none"> • Audio In • Audio Out: One 3.5mm stereo audio output jack for connecting headphones or external powered speakers • Microphone Input: One 3.5mm microphone input jack for connecting an external microphone
2	Ethernet	One RJ45 Ethernet port providing LAN capabilities
3, 8, 9	USB	Seven USB 2.0 type A ports
4	VGA	One D-SUB VGA output port for connecting the display head
5	Parallel	Standard 25-pin connector port
6	Serial	Three standard serial ports
7	PS/2 universal	Mouse (left) and keyboard (right)
8	Customer display	Customer display / USB 2.0; the max loading on this port is 5VDC @ 1.5A
10	Printer power	One 24V DC printer power port
11	Compact flash	Standard CF port
12	Speaker power	Power switch for internal speakers
13	Cash drawer	RJ11, 6 position (12V/24V default)
14	Powered serial	Two powered serial ports, 5V default/12V
15	Main power	AC power

NOTE: *The customer display, fingerprint reader, and barcode scanner are designed to connect to the USB 2.0 ports on the I/O panel. If all three peripherals were connected, there would be four USB 2.0 ports remaining.*

OPTIONS AND UPGRADES

Adding Optional Peripherals

When adding a peripheral, complete installation and setup instructions are provided with the field-installable kits. The following peripherals are available in field-installable kits:

- Magnetic stripe reader (MSR)
- Customer display
- Fingerprint reader (FPR)
- Barcode scanner (1-D or omni-directional/2-D)
- Wireless mini-PCI kit
- Hard disk drive
- Printer power cable

NOTE: *The peripherals described are all options that are purchased separately.*

NOTE: *Testing software is available in the folder **15D1 Test Applications**, which is located on the desktop.*

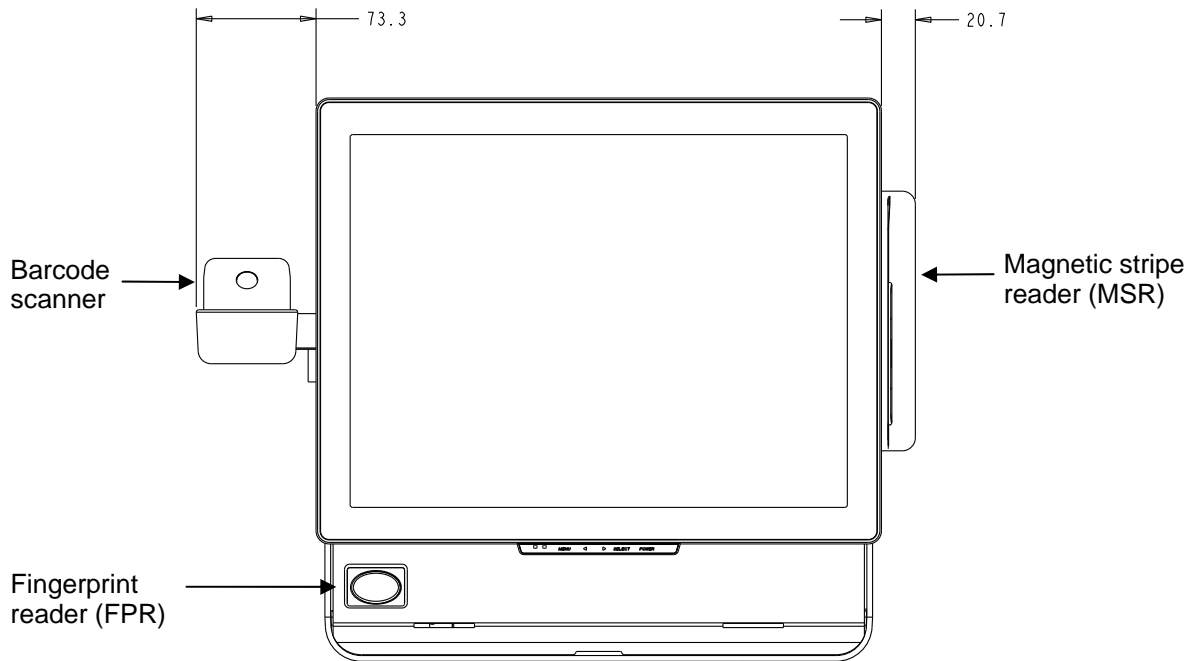

Magnetic Stripe Reader (MSR)

You can add a magnetic stripe reader (MSR) to the 15D1 touchcomputer using a USB port located on the display head.

The MSR is a USB 2.0 device that reads all three data stripes on standard credit cards or driver's licenses conforming to ISO/ANSI standards. The MSR has foreign language capability. The credit card is read by sliding the credit card forward or backward through the MSR, stripe side toward the display. The MSR is powered from the USB port; no external power is needed. The MSR features are:

- Reads up to 3 tracks of information
- Bidirectional swipe reading
- Superior reading of high jitter, scratched, and worn MagStripe cards
- Reliable for over 1,000,000 card swipes
- Reads ISO7811, AAMVA, and most other card data formats
- PC software makes configuration changes easy
- Swipe speeds from 3 to 60 inches per second
- Interfaces: USB-KB and USB-HID

- Fully supports USB 2.0
- Elo part number E145919

Testing the MSR

Testing in USB MSR Keyboard (KB) Emulation Mode

1. Open the Notepad application (click **Start > Accessories > Notepad**).
2. Slide the card through the MSR and verify that the data is displayed in the application window.

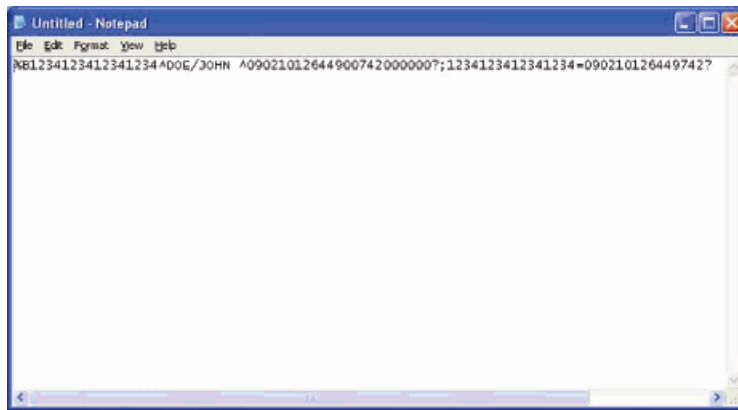

Testing in USB MSR Human Interface Device (HID) Mode

1. Double-click the **MagSwipe HID Demo** icon to start the test application.

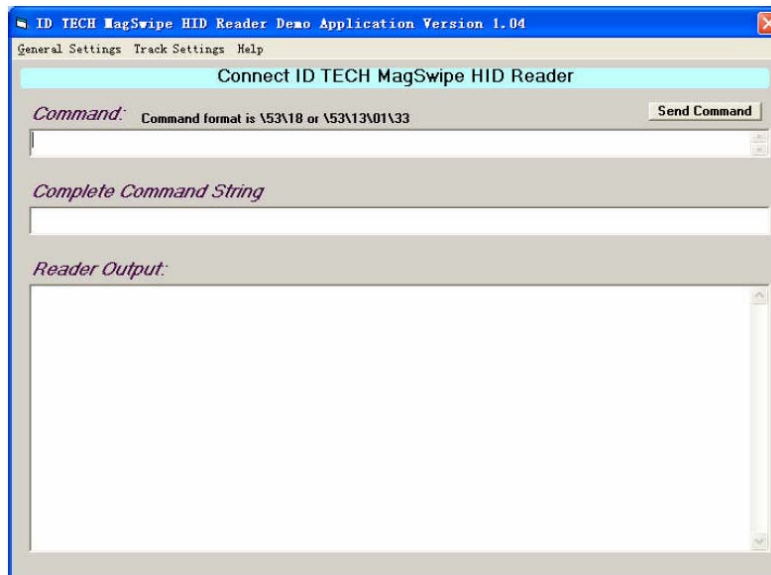

- Slide a card through the MSR and verify that the data is displayed in the application window.



- If the card ID appears in the Reader Output window, the reader is functioning.

Customer Display

You can optionally add a customer display to the 15D1 touchcomputer. Each display has two lines of 20 characters (2x20 VFD).

The customer display can be adjusted to a 30-degree range up and down and swivels 30 degrees side to side.

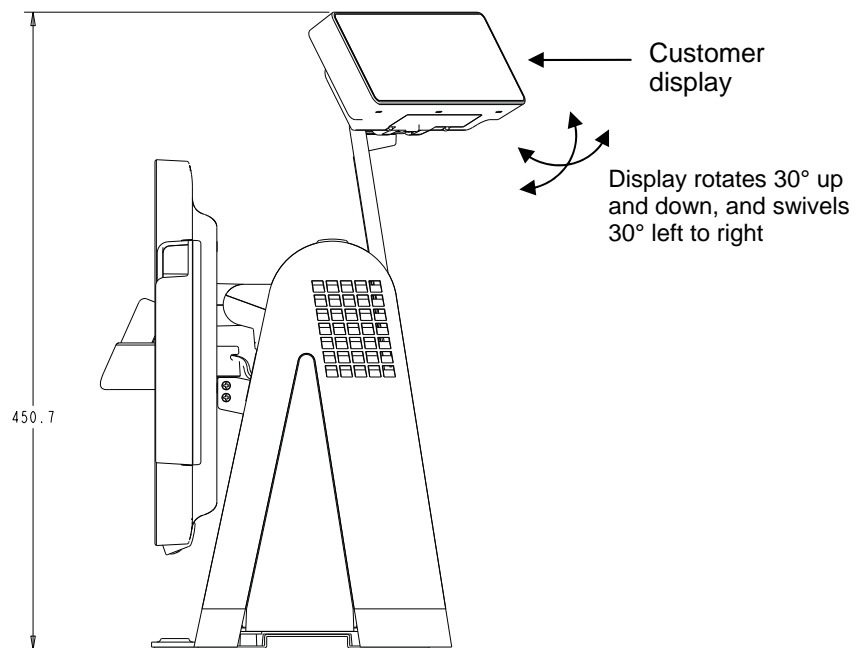

Feature	Description
Display type	Vacuum fluorescent display
Display color	Red
Display pattern	5 x 7 dot matrix
Brightness	350-600 cd/m ²
Characters available	95 alphanumeric & 32 international characters
Dot size (X x Y)	0.86 x 1.2 mm
Font size	5.5(W) x 10.5(H)
Character number	20 characters by 2 lines, for a 5 x 7 dot matrix font
Interface	USB
Part number	E326629

Testing the Customer Display

To test the customer display, follow these steps:

1. Double-click the **VFD Test** icon in the **15D1 Test Applications** folder on the desktop.
2. Select the correct COM port (refer to Device Manager).
3. Enter a line of text into the **Text:** field.
4. Click **Initialize**.
5. Verify that the device shows the line of text entered.

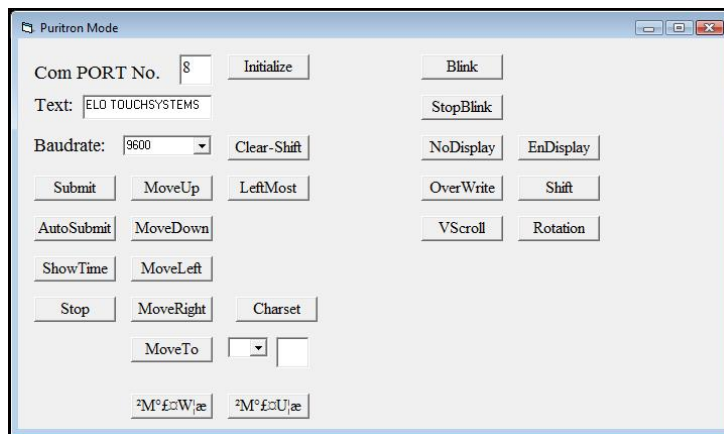

Fingerprint Reader (FPR)

The fingerprint reader is powered by the USB bus. The reader optically scans the fingerprint when the user touches the glowing window. Optical technology gives the highest quality fingerprint scans and reliability.

Fingerprint reader specifications are shown in the table below.

Feature	Specification
Fingerprint reader	DigitalPersona U.are.U 4000B
Power supply	5.0VDC +/- 0.25V
Current draw – scanning mode	190 mA (typical)
Current draw – idle mode	140 mA (typical)
Current draw – suspend mode	1.5 mA (typical)
Image resolution	512 dpi
Image color	8-bit gray level
Scan capture size	14.6mm (nominal width) x 18.1mm (nominal length)
Image capture speed	100 ms
USB type	1.0, 1.1, or 2.0
Operating temperature	0 to 40°C
Electrostatic discharge (ESD)	Up to 15kV mounted in case
Part number	E373639

Testing the FPR

1. Double-click the **Fingerprint Reader Test** icon to start the test application.
2. Place your finger on the fingerprint reader sensor and verify that the image of your fingerprint is displayed on the application window.



Barcode Scanner

There are two types of optional USB barcode scanners: 1-D or omni-directional. The barcode scanner is only an option if the speaker bar is present.

When a scanner is chosen, a USB-SSI (Simple Serial Interface) converter board is included. Both barcode scanners are powered with the USB interface.

- One-dimensional scanner (Elo P/N E946856) specifications:
 - Ability to generate 1-D scanning pattern
 - Low-cost solution
 - USB powered
 - Easy communication between host and scanner
 - Visible laser diode operating at 650nm
 - 100+ scans/sec.
 - RoHS-compliant

- Omni-directional scanner (Elo P/N E449881) specifications:
 - Ability to generate omni-directional scanning pattern
 - Maximum performance
 - 2-D scanning ability (PDF417, MicroPDF)
 - USB powered
 - Easy communication between host and scanner
 - Visible laser diode operating at 650nm
 - 600+ scans/sec.
 - RoHS compliant
- USB-SSI converter board (Elo P/N E580321) specifications:
 - Ability to convert from serial interface to USB interface and vice versa.
 - Compact size
 - Input voltage: 5V
 - BuzzerWireless card

Enabling 2-D Scanning

The scanner default settings do not enable 2-D barcode reading ability. To enable this option, follow these steps:

1. Scan the barcodes below to activate PDF417 and MicroPDF417. These are both types of 2-D barcodes.



Enable PDF417

(01h)



Enable MicroPDF417

(01h)

2. Now scan the barcode below to change the scanning pattern. Using this scanning pattern allows you to read 2-D barcodes (you can still read 1-D barcodes).



**Always Raster
(02h)**

Testing the Barcode Scanner

1. Determine which port the barcode scanner is using:
 - a. Click **Start > Settings > Control Panel** (in Windows XP) or **Start > Control Panel** (in Vista).
 - b. In the Windows Control Panel screen, double-click the **Computer Management** application.
 - c. In Computer Management, select **Device Manager**. In the right pane, look under the **Ports** section, and note the **COM** value (COM1, COM2, COM3, and so on) of the USB-Serial Port object.

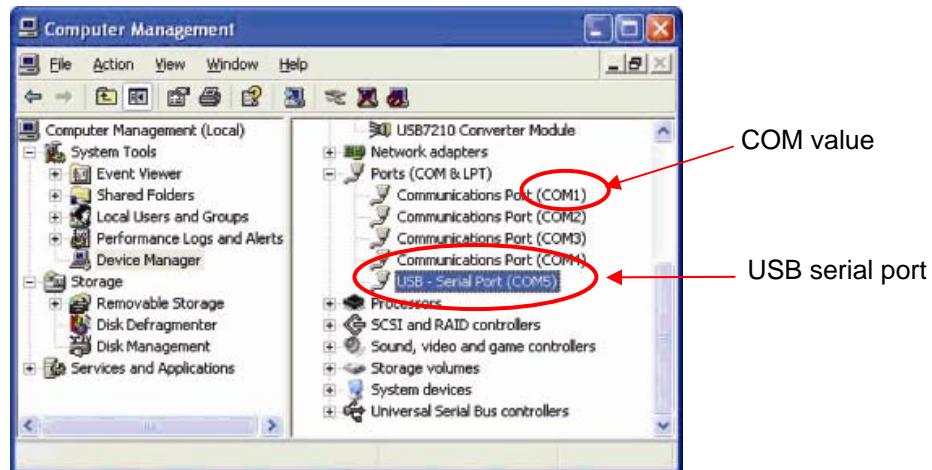

2. From the **15D1 Test Applications** folder on the desktop, double-click the **Barcode Scanner Test** icon to start the SSIContainer application.

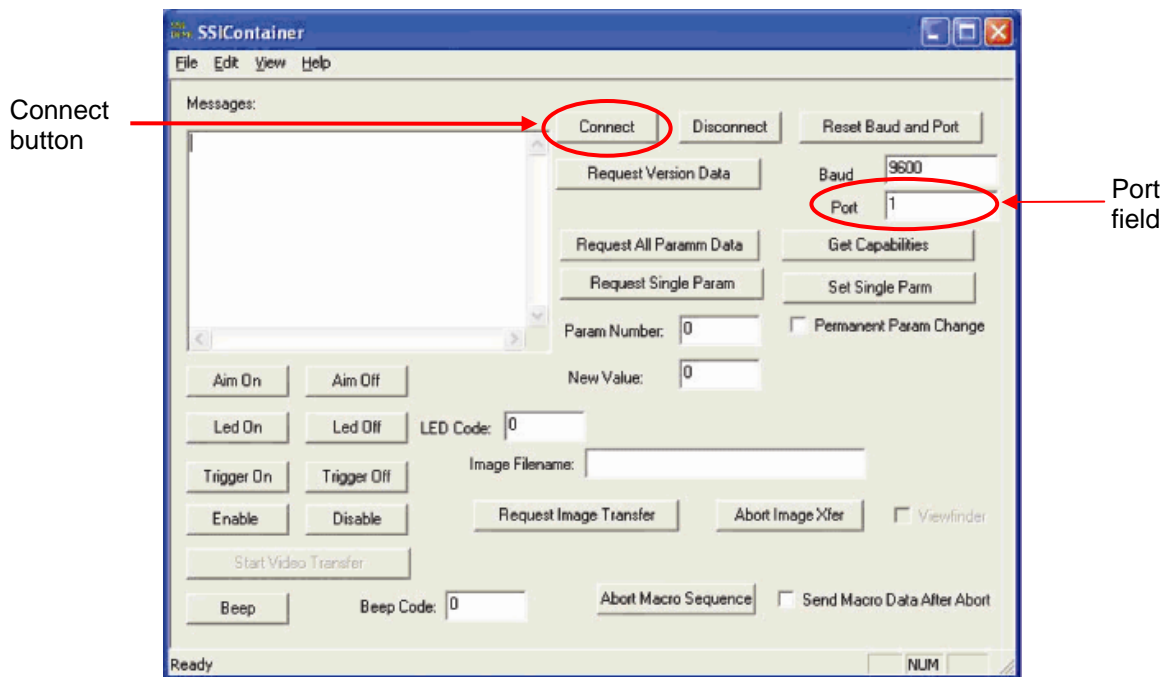

3. Change the **Port** field value to match the value you retrieved from the Device Manager.
4. Click **Connect**. You should see the text “Connected” in the Messages field.

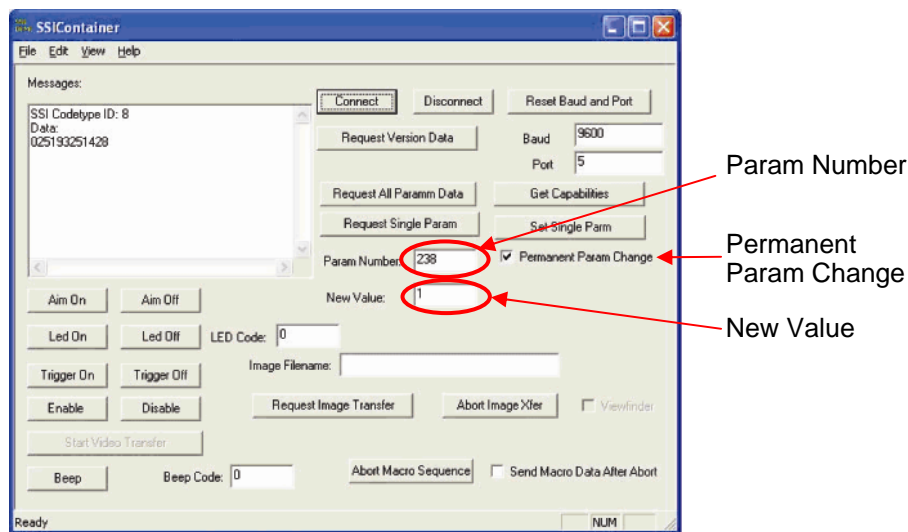

5. In the box labeled **Param Number**, enter the value **238**.
6. In the box labeled **New Value**, enter the value **1**.
7. Check the box labeled **Permanent Param Change**.

8. Scan a barcode (sample given below). The scanned data should appear in the “Messages” section of SSIContainer screen.



The barcode scanner also has the ability to run in USB-KB emulation mode. To enable this option, please install the required drivers. To find the drivers:

1. Click the **15D1 Setup Files** folder on the desktop.
2. Then click the **Barcode Scanner** folder.
3. Finally, click the **Keyboard Emulation Setup Files** folder, where you can find setup instructions to complete the installation process.

Wireless Card

A wireless card can be installed as an option in the 15D1 touchcomputer to provide wireless LAN capabilities using a mini-PCI slot. A PCI to mini-PCI converter board is provided in the wireless kit.

Typical specifications for the wireless card are:

- Mini-PCI interface
- Compliant to Mini-PCI industry-standard sizing
- 802.11b/g compliant
- Two UFL connectors
- Support for Windows 2000, Windows XP, and Windows Vista 32
- RoHS compliant
- Elo P/N E238795

Testing the Wireless Card

To test the wireless card:

1. From the desktop, click **Start > Settings > Control Panel > Network Connections** (in Windows XP) or **Start > Control Panel** (in Vista).
2. Double-click the **Wireless Network Connections** icon to display available networks and verify that the wireless network is detected.

NOTE: *If a wireless network needs to be initialized, please see your system administrator.*



Third-Party Peripherals

The 15D1 touchcomputer includes two pre-configured ports for a printer and cash drawer. These peripherals are not available from Elo TouchSystems.

Printer Port

A 24VDC printer power port to connect a compatible receipt printer is provided. The 24VDC printer power cable is Elo P/N E337867.

Cash Drawer Port

We provide a standard RJ11 port to attach a cash drawer.

Testing the Cash Drawer Port

1. Connect the cash drawer to the touchcomputer using a cable with the correct wiring definition.

2. In the **15D1 Test Applications** folder on the desktop, double-click the **FD2XX Test** icon to start the test program. The screen displays “Display is open.”

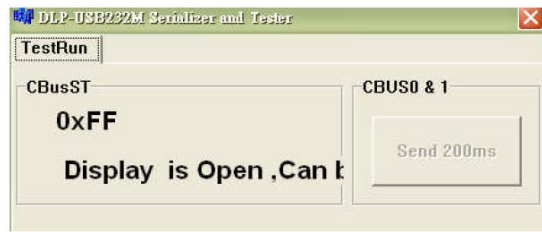

3. Turn off the test equipment.

The screen displays “Display is closed.”



4. Click Send 200ms.

The software automatically turns on the cash drawer.

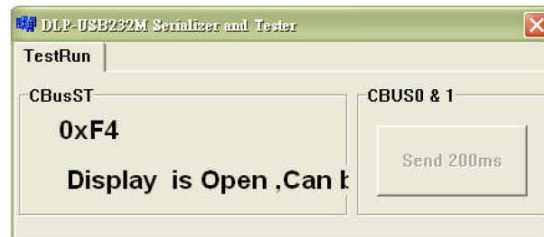

For additional information, see “Cash Drawer Port Specifications” on page 36.

Additional Hard Drives

The 15D1 touchcomputer comes with one standard 80GB hard disk drive. You can add an optional second SATA hard disk drive (Elo P/N E828965).

Elo POS Demo Software

POS demo software created by Elo TouchSystems is located on the desktop. The software can be found in the folder **Elo POS Demo Software**.

4

SAFETY AND MAINTENANCE

Safety

Here is some important information on the proper setup and maintenance of your touchcomputer.

- To reduce the risk of electric shock, follow all safety notices and never open the touchcomputer case.
- Turn off the product before cleaning (refer to “Care and Handling” on page 30 for proper cleaning methods).
- Your touchcomputer is equipped with a 3-wire, grounding power cord. The power cord plug only fits into a grounded outlet. Do not attempt to fit the plug into an outlet that has not been configured for this purpose. Do not use a damaged power cord. Only use the power cord that comes with your Elo TouchSystems touchcomputer. Use of an unauthorized power cord might invalidate your warranty.
- The slots located on the sides and top of the touchcomputer case are for ventilation. Do not block or insert anything inside the ventilation slots.
- It is important that your touchcomputer remains dry. Do not pour liquid into or onto your touchcomputer. If your touchcomputer becomes wet, do not attempt to repair it yourself.

Care and Handling

The following tips help keep your touchcomputer functioning at the optimal level.

- To avoid risk of electric shock, do not disassemble the power adapter or display unit cabinet. The unit is not user serviceable. Remember to unplug the display unit from the power outlet before cleaning.
- Do not use alcohol (methyl, ethyl, or isopropyl) or any strong solvent. Do not use thinner or benzene, abrasive cleaners, or compressed air.
- To clean the display unit cabinet, use a cloth lightly dampened with a mild detergent.
- Avoid getting liquids inside your touchcomputer. If liquid does get inside, have a qualified service technician check it before you power it on again.
- Do not wipe the screen with a cloth or sponge that could scratch the surface.
- To clean the touchscreen, use window or glass cleaner. Put the cleaner on the rag and wipe the touchscreen. Never apply the cleaner directly on the touchscreen.



Warning

This product consists of devices that might contain mercury, which must be recycled or disposed of in accordance with local, state, or federal laws. (Within this system, the backlight lamps in the monitor display contain mercury.)

WEEE Directive



In the European Union, the Waste Electrical and Electronic Equipment (WEEE) directive label shown to the left indicates that this product should not be disposed of with household waste. It should be deposited at an appropriate facility for recovery and recycling.

Recovering the Operating System

If for any reason the touchcomputer's operating system and software need to be recovered, insert the included recovery disk into an external DVD-ROM drive and reboot the touchcomputer. Follow the on-screen instructions to complete recovery.

NOTE: *All data is deleted during the recovery process. The user must back up files when necessary. Elo TouchSystems does not accept liability for lost data or software.*

NOTE: *The end user must adhere to Microsoft's Licensing Agreement.*

5

TECHNICAL SPECIFICATIONS

Touchcomputer Specifications

NOTE: *Not all operating systems or options are supported in all regions. Please contact your local Elo TouchSystems representative for details.*

Feature	Description
Processor	Intel Celeron 430M 1.8GHz CPU 512K L2 cache, w/800MHz front-side bus, LGA775 Pkg
RAM	512MB 667MHz DDR2 standard on one slot Two slots are available. Recommended vendor is Transcend. Expandable up to 4GB max—DDR2-667(PC2-5400) or DDR2-800(PC2-6400) Dual channel
Northbridge	Intel G31
Southbridge	Intel ICH7
Audio	Azalia ALC883 Codec, 6 audio channels
Video	Intel GMA 3100 (Vista Aero compatible)
Operating system	Microsoft Windows XP Professional SP3 Microsoft Windows Embedded for Point of Service (WEPOS) Microsoft Windows Vista Business

Feature	Description
Ports	7 x USB 2.0 ports 1 x 12V/24V default cash drawer port (jumper selectable) 3 x RS232 serial ports 2 x 5V default/12V powered RS232 serial ports (jumper selectable) 2 x PS/2 (keyboard and mouse)
Audio ports	1 x 3.5mm mic-in 1 x 3.5mm audio-in 1 x 3.5mm audio-out
Networking	1 x 10/100BASE-T Ethernet port (LAN RJ45)
BIOS	AMI
Real-time clock	Replaceable lithium-ion battery for clock
Storage	1 x 2.5-inch 80GB SATA HDD (minimum, optional second drive) 1 Compact Flash type I (tested with Transcend, Apacer, Kingston, and SanDisk)
Power supply	Internal 12VDC universal-type power supply brick AC input voltage: 100-240V AC Input frequency: 50-60Hz Input current: 2.5-5A Max output power: 270W DC output: +3.3V / 5.0A +5V / 16.0A +12V / 12.0A +24V / 2.3A +5Vsb / 3A -12V / 0.4A

Feature	Description
Max. power rating	15D1 touchcomputer (without peripherals, receipt printer, cash drawer, or power serial ports connected): 169.95 W Cash drawer: 2.4 W max. Receipt printer; 45.6 W max. Powered serial ports: 24 W max Total power drawn with all possible peripherals: 252.45 W
Touch technologies	Acoustic Pulse Recognition (APR) AccuTouch (AT) IntelliTouch (IT)
Touchcomputer dimensions (max.)	Width: 345 mm Height: 288 mm Depth: 212 mm Dimensions vary with tilt angle and options selected
Shipping box dimensions	Width: 450mm Height: 475mm Depth: 340mm
Weight with no options	Actual: 10.03kg (22.1 lb.) Shipping: 12.16kg (26.8 lb.)
Display	15-inch diagonal 4x3 aspect ratio Active matrix TFT LCD
Optimal (native) resolution	1024 x 768
Backlight lamp life	Minimum 50,000 hours to half brightness
Agency approvals	UL/cUL, CE, BSMI, NOM, AR, CCC, EK, KCC, GOST-R, RCM, C-Tick, VCCI
Speakers (internal)	Two 2-Watt/channel speakers
User controls	Power and user controls with lockout function for public use
Other features	User-accessible hard drive Touchscreen sealed to bezel and LCD Security lock receptacle, Kensington

Feature	Description
Peripheral options and upgrades	Magnetic stripe reader, 3 tracks Customer display 2 x 20 VFD Biometric fingerprint reader Barcode scanner (1-D or omni/2-D) Second 80GB hard drive Wireless card Printer power cable

Connector Specifications

Serial Ports

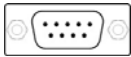

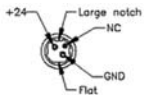

Pin #	Standard Ports Signal Name	Powered Ports Signal Name
1	SER DCD	SER DCD
2	SER RXD	SER RXD
3	SER TXD	SER TXD
4	SER DTR	SER DTR
5	SER GND	SER GND
6	SER DSR	SER DSR
7	SER RTS	SER RTS
8	SER CTS	SER CTS
9	SER RI	5V(default)/ 12V

Printer Power Input Pin Definition

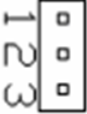

Pin #	Signal Name
1	+24V
2	NC
3	Ground
4	Flat

Serial Port Power Selection

J1/J2	Setting	Function
	All pins open	No power
	Pins 1-2 short/closed	5V (default)
	Pins 2-3 short/closed	12V



Cash Drawer Port Specifications

The cash drawer port is 12/24V compatible.

Cash Drawer Port Signal Definition

Pin #	Signal Name
1	Frame ground
2	CD 1 drawer kick-out drive signal 1
3	SW (+) connected on the side of the open/closed detection switch on the drawer
4	L (+) +12V/24V (default) for drawer kick-out supplied
5	CD 2-drawer kick-out drive signal 2
6	(-) Ground

Cash Drawer Port Power Selection

J3	Setting	Function
	Pins 1-2 short/closed	12V
	Pins 2-3 short/closed	24V (default)

Display Screen Specifications

Feature	Specification
LCD display	15.0-inch diagonal TFT active matrix LCD
Video input signal	Analog RGB (0.7Vp-p)
Data display channel (DDC) function (plug & play)	DDC1, 2B compliant (EDID data only)
Display size (useful screen area)	304.128mm (H) x 228.096mm (V)
Maximum touchcomputer dimensions	288mm (H) x 345mm (W) x 212mm (D) * Dimensions vary with tilt angle and options selected
Pixel pitch	0.297mm (H) x 0.297mm (V)
Display mode	VGA 640 x 350 (70Hz) VGA 720 x 400 (70Hz) VGA 640 x 480 (60Hz) MAC 640 x 480 (66Hz) VESA 640 x 480 (72 / 75Hz) VESA 800 x 600 (56 / 60 / 72 / 75Hz) MAC 832 x 624 (75Hz) VESA 1024 x 768 (60 / 70 / 75Hz) SUN 1024 x 768 (65Hz) Note: <i>If input fH>60kHz, or fV>75Hz, then OSD displays an out of range warning.</i>
Brightness (typical) No touch AccuTouch IntelliTouch APR (7000 and 7010)	225 cd/m ² (typical); 170 cd/m ² (min.) 200 cd/m ² (typical); 150 cd/m ² (min.) 225 cd/m ² (typical); 170 cd/m ² (min.) 225 cd/m ² (typical); 170 cd/m ² (min.)
Response time	T _{rise} : 2.3 ms (typical) T _{fall} : 6 ms (typical)
Display color	16.7 million colors
Vertical viewing angle (up/down)	60° looking up typical at a CR=10 65° looking down typical at a CR=10

Feature	Specification
Horizontal viewing angle (left/right)	70° looking left typical at a CR=10 70° looking right typical at a CR=10
Contrast ratio	700:1 (typical)
Optional touchscreens	AccuTouch, IntelliTouch, Acoustic Pulse Recognition 7000 and 7010

Environmental Specifications

Feature	Specification
Temperature Ranges Operating (independent of altitude) Non-operating (independent of altitude)	0 to 35°C -20 to 60°C
Humidity Operating (noncondensing) Non-operating (38.7°C maximum wet bulb temperature)	20 to 80% 5 to 95%
Altitude Operating Non-operating	0 to + 12,000 feet [3,658m] Equivalent to 14.7 to 10.1 psia 0 to + 40,000 feet [12,192m] Equivalent to 14.7 to 4.4 psia

6

TECHNICAL SUPPORT

Technical Assistance

There are three methods to obtain contact information for technical assistance on the touchcomputer:

- The touchcomputer
- The web
- The phone

Using the Touchcomputer

You can access support information in System Properties by clicking the **Support Information** button. You can get to System Properties by either of the following methods:

- Right-click **My Computer** and choose **Properties**.
- or
- Click the **Start** button, select **Control Panel**, and double-click the **System** icon.

Using the Web

For online self-help, go to www.elotouch.com/go/websupport.

For technical support, go to www.elotouch.com/go/contactsupport.

For current Elo news, product updates, and announcements, or to register to receive our Touchcomputer newsletter, go to www.elotouch.com/go/news.

Using the Phone

Call toll-free 1-800-ELO-TOUCH (1-800-356-8682).

REGULATORY INFORMATION

I. Electrical Safety Information

A) Compliance is required with respect to the voltage, frequency, and current requirements indicated on the manufacturer's label. Connection to a different power source than those specified herein may result in improper operation, damage to the equipment, invalidation of warranty, or a fire hazard if the requirements are not followed.

B) There are no operator-serviceable parts inside this equipment. There are hazardous voltages generated by this equipment which constitute a safety hazard. Service should be provided only by a qualified service technician.

C) This equipment is provided with a detachable power cord which has an integral safety ground wire intended for connection to a grounded safety outlet.

1) Do not substitute the cord with other than the provided approved type. Under no circumstances use an adapter plug to connect to a 2-wire outlet as this defeats the continuity of the grounding wire.

2) The equipment requires the use of the ground wire as a part of the safety certification. Modification or misuse can provide a shock hazard that can result in serious injury or death.

3) Contact a qualified electrician or the manufacturer if there are questions about the installation prior to connecting the equipment to main power.

II. Emissions and Immunity Information

A) Notice to Users in the United States: This equipment has been tested and found to comply with the limits for a Class A digital device, pursuant to Part 15 of FCC Rules. These limits are designed to provide reasonable protection against harmful interference in a residential or commercial installation. This equipment generates, uses, and can radiate radio frequency energy, and if not installed and used in accordance with the instructions, may cause harmful interference to radio communications.

B) Notice to Users in Canada: This equipment complies with the Class A limits for radio noise emissions from digital apparatus as established by the Radio Interference Regulations of Industry Canada.

C) Notice to Users in the European Union: Use only the provided power cords and interconnecting cabling provided with the equipment. Substitution of provided cords and cabling may compromise electrical safety or CE Mark Certification for emissions or immunity as required by the following standards: This Information Technology Equipment (ITE) is required to have a CE Mark on the manufacturer's label which means that the equipment has been tested to the following Directives and Standards:

This equipment has been tested to the requirements for the CE Mark as required by EMC Directive 89/336/EEC indicated in European Standard EN 55022 Class A and the Low Voltage Directive 73/23/EEC as indicated in European Standard EN 60950.

D) General Information to all Users: This equipment generates, uses, and can radiate radio frequency energy. If not installed and used according to this manual, the equipment may cause interference with radio and television communications. There is, however, no guarantee that interference will not occur in any particular installation due to site-specific factors.

1) In order to meet emission and immunity requirements, the user must observe the following:

- a) Use only the provided I/O cables to connect this digital device with any computer.
- b) To ensure compliance, use only the provided manufacturer's approved power cord.
- c) The user is cautioned that changes or modifications to the equipment not expressly approved by the party responsible for compliance could void the user's authority to operate the equipment.

2) If this equipment appears to cause interference with radio or television reception, or any other device:

- a) Verify as an emission source by turning the equipment off and on.
- b) If you determine that this equipment is causing the interference, try to correct the interference by using one or more of the following measures:
 - i) Move the digital device away from the affected receiver.
 - ii) Reposition (turn) the digital device with respect to the affected receiver.
 - iii) Reorient the affected receiver's antenna.

iv) Plug the digital device into a different AC outlet so the digital device and the receiver are on different branch circuits.

v) Disconnect and remove any I/O cables that the digital device does not use. (Unterminated I/O cables are a potential source of high RF emission levels.)

vi) Plug the digital device into only a grounded outlet receptacle. Do not use AC adapter plugs. (Removing or cutting the line cord ground may increase RF emission levels and may also present a lethal shock hazard to the user.)

vii) If you need additional help, consult your dealer, manufacturer, or an experienced radio or television technician.

III. Agency Certifications

The following certifications have been issued for the monitor:

- Argentina S-Mark
- Australia C-Tick
- CE
- China CCC
- China RoHS
- FCC
- IMERC
- Japan VCCI
- Korea EK/KCC
- Mexico NOM
- Russia PCT
- Taiwan BSMI
- UL
- cUL
- WEEE

WARRANTY

Except as otherwise stated herein or in an order acknowledgment delivered to Buyer, Seller warrants to Buyer that the Product shall be free of defects in materials and workmanship. With the exception of the negotiated warranty periods; the warranty for the touchcomputer and components of the product is 3 years.

Seller makes no warranty regarding the model life of components. Seller's suppliers may at any time and from time to time make changes in the components delivered as Products or components. Buyer shall notify Seller in writing promptly (and in no case later than thirty (30) days after discovery) of the failure of any Product to conform to the warranty set forth above; shall describe in commercially reasonable detail in such notice the symptoms associated with such failure; and shall provide to Seller the opportunity to inspect such Products as installed, if possible. The notice must be received by Seller during the Warranty Period for such product, unless otherwise directed in writing by the Seller. Within thirty (30) days after submitting such notice, Buyer shall package the allegedly defective Product in its original shipping carton(s) or a functional equivalent and shall ship to Seller at Buyer's expense and risk.

Within a reasonable time after receipt of the allegedly defective Product and verification by Seller that the Product fails to meet the warranty set forth above, Seller shall correct such failure by, at Seller's options, either (i) modifying or repairing the Product or (ii) replacing the Product. Such modification, repair, or replacement and the return shipment of the Product with minimum insurance to Buyer shall be at Seller's expense. Buyer shall bear the risk of loss or damage in transit, and may insure the Product. Buyer shall reimburse Seller for transportation cost incurred for Product returned but not found by Seller to be defective. Modification or repair, of Products may, at Seller's option, take place either at Seller's facilities or at Buyer's premises. If Seller is unable to modify, repair, or replace a Product to conform to the warranty set forth above, then Seller shall, at Seller's option, either refund to Buyer or credit to Buyer's account the purchase price of the Product less depreciation calculated on a straight-line basis over Seller's stated Warranty Period.

THESE REMEDIES SHALL BE THE BUYER'S EXCLUSIVE REMEDIES FOR BREACH OF WARRANTY. EXCEPT FOR THE EXPRESS WARRANTY SET FORTH ABOVE, SELLER GRANTS NO OTHER WARRANTIES, EXPRESS OR IMPLIED BY STATUTE OR OTHERWISE, REGARDING THE PRODUCTS, THEIR FITNESS FOR ANY PURPOSE, THEIR QUALITY, THEIR MERCHANTABILITY, THEIR NONINFRINGEMENT, OR OTHERWISE. NO EMPLOYEE OF SELLER OR ANY OTHER PARTY IS AUTHORIZED TO MAKE ANY WARRANTY FOR THE GOODS OTHER THAN THE WARRANTY SET FORTH HEREIN. SELLER'S LIABILITY UNDER THE WARRANTY SHALL BE LIMITED TO A REFUND OF THE PURCHASE PRICE OF THE PRODUCT. IN NO EVENT SHALL SELLER BE LIABLE FOR THE COST OF PROCUREMENT OR INSTALLATION OF SUBSTITUTE GOODS BY BUYER OR FOR ANY SPECIAL, CONSEQUENTIAL, INDIRECT, OR INCIDENTAL DAMAGES.

Buyer assumes the risk and agrees to indemnify Seller against and hold Seller harmless from all liability relating to (i) assessing the suitability for Buyer's intended use of the Products and of any system design or drawing and (ii) determining the compliance of Buyer's use of the Products with applicable laws, regulations, codes, and standards. Buyer retains and accepts full responsibility for all warranty and other claims relating to or arising from Buyer's products, which include or incorporate Products or components manufactured or supplied by Seller. Buyer is solely responsible for any and all representations and warranties regarding the Products made or authorized by Buyer. Buyer will indemnify Seller and hold Seller harmless from any liability, claims, loss, cost, or expenses (including reasonable attorney's fees) attributable to Buyer's products or representations or warranties concerning same.

INDEX

- address, Elo TouchSystems, 48
- advertising brackets, 7
- audio ports, description, 15
- barcode scanner
 - enabling 2-D scanning, 23
 - overview, 22
 - specifications, 22
 - testing, 24
- base power status, 11
- base, securing, 7
- box contents, 1
- brackets, advertising, 7
- cables
 - included, 1
 - printer power, 27
- calibration, 5
- cash drawer port
 - description, 15
 - overview, 27
 - specifications, 36
 - testing, 27
- certifications, 42
- compact flash port, 15
- contact information, 39
- controls, location diagram, 9
- customer display
 - overview, 19
 - port description, 15
 - specifications, 20
 - testing, 20
- customer support, 39
- display screen
 - adjusting, 2
 - specifications, 37
- email, Elo TouchSystems, 48
- enabling or disabling power, 11
- environmental specifications, 38
- Ethernet port, 15
- fingerprint reader (FPR)
 - overview, 21
 - specifications, 21
 - testing, 21
- hard drives
 - adding additional, 28
 - LED activity, 12
- head power status, 12
- input/output (I/O) panel
 - accessing, 12
 - illustration, 13
- language selection, 2
- LCD
 - adjusting, 2
 - specifications, 37
- LEDs
 - base, 11
 - hard drives, 12
 - head, 12
 - location diagram, 9
 - touch, 12
- magnetic stripe reader (MSR)
 - overview, 17
 - specifications, 17
 - testing, 18
- maintenance
 - care and handling, 29
 - software, 30
- mounting options, 7
- on-screen display (OSD)
 - enabling or disabling menu, 11
 - menu settings, 10
- operating system
 - recovering, 30
 - setting up, 2
- operation, 9
- options, adding, 16
- parallel ports, 15
- peripherals
 - adding, 16
 - third-party, 27
- phone number, Elo TouchSystems, 39, 48
- ports
 - accessing, 12

- audio, 15
- cash drawer, 15
- compact flash, 15
- customer display, 15
- Ethernet, 15
- illustration, 13
- parallel, 15
- printer power, 15
- PS/2 universal, 15
- serial, 15
- speaker, 15
- USB, 15
- VGA, 15
- power
 - base, 11
 - enabling or disabling button lock, 11
- printer power port
 - about, 27
 - cables, 27
 - description, 15
 - specifications, 35
- PS/2 universal port, 15
- receipt printer specifications, 27
- regulatory information, 41
- safety, 29
- scanning, enabling 2-D, 23
- serial ports
 - description, 15
 - specifications, 35, 36
- setup
 - display screen, 2
 - language selection, 2
 - mounting options, 7
 - operating system, 2
 - time zone selection, 5
 - touchscreen calibration, 5
 - unpacking, 1
- software
 - demo, 28
 - recovery, 30
- specifications
 - barcode scanner, 22
 - cash drawer port, 36
 - connectors, 35
 - customer display, 20
 - display screen, 37
 - environmental, 38
 - fingerprint reader, 21
 - hardware, 32
 - magnetic stripe reader, 17
 - printer power port, 35
 - receipt printer, 27
 - serial ports, 35, 36
 - technical, 32
 - wireless card, 26
- speaker port, 15
- technical specifications, 32
- technical support, 39
- third-party peripherals, 27
- time zone selection, 5
- touch power status, 12
- touchscreen
 - calibrating, 5
 - care and handling, 29
- upgrades, adding, 16
- USB ports, 15
- VGA port description, 15
- warranty, 44
- website, Elo TouchSystems, 39, 48
- WEEE directive, 30
- wireless card
 - overview, 26
 - specifications, 26
 - testing, 26

www.elotouch.com

Get the latest...

- *Product information*
- *Specifications*
- *News on upcoming events*
- *Press release*
- *Software drivers*
- *Touch Monitor Newsletter*

Getting in Touch with Elo

To find out more about Elo's extensive range of touch solutions, visit our Website at www.elotouch.com or simply call the office nearest you:

North America

Elo TouchSystems
301 Constitution Drive
Menlo Park, CA 94025
USA

(800) ELO-TOUCH
(800) 356-8682
Tel 650-361-4800
Fax 650-361-4747
customerservice@elotouch.com

Germany

Tyco Electronics Raychem GmbH
(Elo TouchSystems Division)
Finsinger Feld 1
D-85521 Ottobrunn
Germany

Tel +49 (0)(89) 60822-0
Fax +49(0)(89) 60822-180
elosales@elotouch.com

Belgium

Tyco Electronics Raychem
N.V.
(Elo TouchSystems Division)
Diestsesteenweg 692
B-3010 Kessel-Lo
Belgium

Tel +32(0)(16)35 21 00
Fax +32(0)(16)35 21 01
elosales@elotouch.com

Asia-Pacific

Sun Hamada Bldg. 2F
1-19-20 ShinYokohama
Kanagawa 222-0033
Japan

Tel +81(45)478-2161
Fax +81(45)478-2180
www.tps.co.jp

© 2008 Tyco Electronics Printed in USA



Our commitment. Your advantage.