

**User's Manual**

**FlexScan<sup>®</sup>**  
**F67/FX·D7**  
**T68/TX·D7**  
**Color Display Monitor**

# CONTENTS

---

 <b>PRECAUTIONS</b>	<b>4</b>
------------------------------------------------------------------------------------------------------	----------

<b>INTRODUCTION</b>	<b>9</b>
---------------------	----------

About This Manual .....	9
Package Contents .....	9

<b>1 INSTALLATION</b>	<b>10</b>
-----------------------	-----------

1-1 Controls & Connectors .....	10
Front .....	10
Rear .....	11
1-2 Connecting the monitor to the PC .....	12
1-3 Setting the resolution .....	13

<b>2 SCREEN ADJUSTMENT</b>	<b>14</b>
----------------------------	-----------

2-1 How to use the ScreenManager .....	14
ScreenManager Menus .....	14
Entering the ScreenManager .....	16
Enter the Settings .....	16
Save & Exit .....	16
2-2 Imaging Adjustment .....	18
Using the AUTO-SIZING button .....	18
Brightness, Contrast, Size, Position .....	19
Geometry, Tilt, Uniformity .....	20
Convergence .....	21
Moiré Reduction .....	22
2-3 Color Adjustment .....	23
Outline .....	23
Adjusting the Standard mode .....	24
Adjusting the Custom mode .....	25
2-4 Power-save Setup .....	28
Set-up Procedure .....	29
AutoPower Function .....	32

2-5 Other Settings .....	33
Degaussing .....	33
Input Priority .....	33
Beep .....	34
Menu Position, Menu Contrast .....	35
Signal Filter .....	35
Reset .....	35
<b>3 TROUBLESHOOTING .....</b>	<b>36</b>
3-1 Troubleshooting .....	36
<b>4 GETTING THE MOST FROM YOUR MONITOR .....</b>	<b>43</b>
4-1 Adjustment Lock .....	43
4-2 Connecting two PCs to the Monitor .....	43
4-3 Optional <i>i</i> -Sound™ Sound Unit .....	44
4-4 Making use of USB (Universal Serial Bus) .....	44
<b>5 CLEANING .....</b>	<b>48</b>
<b>6 SPECIFICATIONS .....</b>	<b>49</b>
T68/TX-D7 .....	49
F67/FX-D7 .....	50
<b>APPENDIX .....</b>	<b>i</b>

Copyright© 1999 by EIZO NANA O CORPORATION (“ENC”). All rights reserved. No part of this manual may be reproduced, stored in a retrieval system, or transmitted, in any form or by any means, electronic, mechanical, or otherwise, without the prior written permission of EIZO NANA O CORPORATION.

EIZO NANA O CORPORATION is under no obligation to hold any submitted material or information confidential unless prior arrangements are made pursuant to EIZO NANA O CORPORATION's receipt of said information.

Although every effort has been made to ensure that this manual provides up-to-date information, please note that EIZO monitor specifications are subject to change without notice.

ENERGY STAR is a U.S. registered mark.

Apple and Macintosh are registered trademarks of Apple Computer, Inc.

DPMS is a trademark and VESA is a registered trademark of Video Electronics Standards Association.

Windows is a registered trademark of Microsoft Corporation.

ScreenManager, PowerManager, QuickSet, *i*-Sound and *i*-Station are trademarks of EIZO NANA O CORPORATION.

FlexScan, SuperErgoCoat and EIZO are registered trademarks of EIZO NANA O CORPORATION.

# PRECAUTIONS

## IMPORTANT!

- \* This product has been adjusted specifically for use in the region to which it was originally shipped. The performance of the product, (i.e. picture geometry, picture positioning and color convergence and purity in the case of color monitors) is optimally adjusted to the earth's magnetic field of the specific destination. If operated outside the region to which it was originally shipped, the product may not perform as stated in the specifications.
- \* The manufacturer is not responsible for damage or malfunction caused by improper connection. The power cord should be connected directly to a standard wall power outlet.

## Location of the caution statements

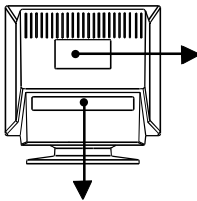

The equipment must be connected to a grounded main outlet.

Jordet stikkontakt skal benyttes når apparatet tilkobles datanett.

Apparaten skall anslutas till jordat nätuttag.



警告	CAUTION	ATTENTION	ACHTUNG
高圧注意 パソコンと電源の方法がた まわらないでください。 内部には高電圧部分が多くあ り、万一むちると危険です。	RISK OF ELECTRIC SHOCK. DO NOT OPEN.	RISQUE DE CHOC ELECTRIQUE. NE PAS OUVRIIR.	GEFAHR DES ELEKTRISCHEN SCHLAGES. RÜCKWÄRT NICHT ENTFERNEN.



## IMPORTANT!

To ensure personal safety and proper maintenance. Please read this section and the caution statements on the monitor (refer to the figure above).

This manual uses the safety symbols below. They denote critical information.

Please read them carefully.



Indicates a prohibited action.



Indicates to ground for safety.



### WARNING

Failure to abide by the information in a WARNING may result in serious injury and can be life threatening.



### CAUTION

Failure to abide by the information in a CAUTION may result in moderate injury and/or property or product damage.

## WARNING

- **If the monitor begins to emit smoke, smells like something is burning, or makes strange noises, disconnect all power connections immediately and contact your dealer for advice.**

Attempting to use a malfunctioning monitor can be dangerous.

- **Do not dismantle the cabinet or modify the monitor.**

Dismantling the cabinet or modifying the monitor may result in electric shock or burn.

- **Keep small objects away from the monitor.**

Small objects may accidentally fall through the ventilation slots into the cabinet, leading to fire, shock, or equipment damage.

- **Keep liquids away from the monitor.**

Spillage into the cabinet may result in fire, electric shock, or equipment damage.

If an object or liquid falls/spills into the cabinet, unplug the monitor immediately. Have the unit checked by a qualified service engineer before using it again.

- **Place the monitor on a strong, stable surface.**

A unit placed on an inadequate surface may fall, resulting in injury or equipment damage.

If the monitor falls, disconnect the power immediately and have the unit checked by a qualified service engineer before using it again. Using a monitor after it has been dropped may result in fire or electric shock.

- **Keep the plastic packing bags away from children and infants.**

Plastic bags can be dangerous. To avoid danger of suffocation, keep the bag away from babies and children.

- **Keep power terminal covers for the optional *i*Sound<sup>®</sup> sound unit away from children and infants.**

Children and infants may accidentally swallow the covers and choke. If swallowed, consult a doctor immediately.

- **The equipment must be connected to a grounded main outlet.**

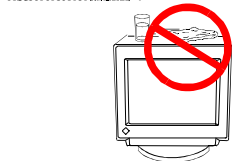
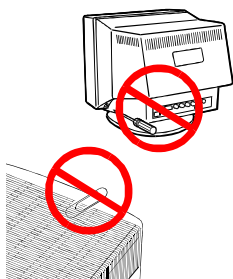

- 
- **Use the enclosed power cord. If using the power cord other than the enclosed one, use the following cord.**

In USA and Canada:

- \* Rating: min. 125 V, 10 A \* Length: max. 2.1 m
- \* Type: SVT
- \* Plug type: NEMA 5-15P, Parallel blade, Grounding type, 125 V, 10 A

In Europe:

- \* Rating: min. 250 V, 10 A \* Length: max. 2.1 m
- \* Type: H05VV-F 3G 1 mm<sup>2</sup>

Use a plug type approved by the country where you use.  
Failure to do so may cause fire or electric shock.



- **Do not overload your power circuit, as this may result in fire or electric shock.**
- **For proper connections of the power cord, be certain to plug the power cord to the provided monitor connector and directly to a wall outlet.**

By not doing so may result in fire or electric shock.

- **Handle the power cord with care.**

- \* Do not place the cord underneath the monitor or other heavy objects.
- \* Do not pull on the cord.
- \* Do not attempt to repair a damaged cord.

If the power cord becomes damaged, stop using it. Use of a damaged cord may result in fire or electric shock.

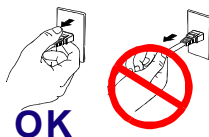
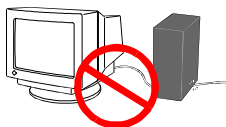

- **To disconnect the power cord, grasp the plug firmly and pull.**

Never tug on the cord, doing so may cause damage and could result in fire or electric shock.



## CAUTION

---

**Be careful when taking the monitor out of the carton:**

- **Disconnect the power cord, signal cables and remove the optional i-Sound<sup>®</sup> sound unit and i-Station<sup>®</sup> USB hub (if applicable) when moving the monitor.**

Moving the monitor with the cord attached or lifting it by the i-Sound sound unit or i-Station USB hub is dangerous. It may result in injury or equipment damage.

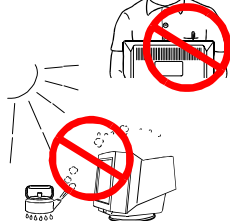

- **Handle with care when carrying the monitor**

Note that the monitor is heavier at the front than at the rear. Do not move it alone. Always work with another person.

The screen is optically coated to reduce glare. Keep hard objects (such as buttons, tie pins, and other clothing accessories) away from the screen surface to prevent scratches.

- **Set the monitor in an appropriate location.**

- \* Do not install in a dusty or humid environment.
- \* Do not place in a location where light shines directly on the screen.
- \* Do not place near heat generating devices or a humidifier.

- **Use an easily accessible power outlet.**

This will ensure that you can disconnect the power quickly in case of a problem.

- **Do not sit on the cabinet or place any heavy objects on the cabinet.**

A unit with heavy objects on it may fall or be damaged and result in injury.

- **Do not block the ventilation slots on the cabinet.**

- \* Do not place books or any other papers on the ventilation slots.
- \* Do not install the monitor in a closed space.
- \* Do not use the monitor laying down or upside down.
- \* Do not remove the tilt-swivel stand.

Using the monitor in this way blocks the ventilation slots and prevents proper airflow, leading to fire or other damage.

- **Do not remove the tilt-swivel stand.**

The stand is required to maintain clearance for the ventilation slots on the bottom of the cabinet. Removing the stand will block these slots and may result in fire or electric shock.

- **Do not touch the plug with wet hands.**

Touching the plug with wet hands is dangerous and can cause electrical shock.

- **At the end of the day or if you plan to leave the monitor unused for an extended period, after turning off the power switch disconnect the power cord from the wall socket so that no power connections are made.**

- **Unplug the monitor before cleaning it.**

Cleaning the monitor while it is plugged into a power outlet may result in electric shock.

---

**For users of the EIZO optional *i*Sound™ sound unit and *i*-Station™ USB hub**



- When adjusting the viewing angle of the monitor, do not do so by handling the sound unit or USB hub.

Adjusting the monitor in this way may break the unit or cause bodily injury.

## Others



- Do not install the monitor within an area subject to strong magnetic fields (for example, in the vicinity of a speaker, except the optional *i*-Sound unit, or a high-voltage transformer). Magnetic fields can cause noise, image shaking, and other distortions.

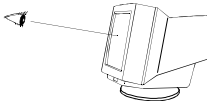

- Generally, for maximum viewing comfort position the monitor slightly below eye level. Staring at the monitor for prolonged periods can cause eye strain. Be sure to take adequate rests. (A 10-minute rest period each hour is suggested.)

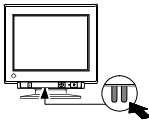

- Do not remove the covers to the power terminal for the optional *i*-Sound speaker unit for any reason except to attach the unit.



# INTRODUCTION

## About This Manual

This manual explains the precautions, features, specifications, and operation of your EIZO monitor. For convenience, a "ScreenManager Quick Reference" guide has been included which shows how to implement basic adjustments with the ScreenManager utility.

**NOTE**

- This manual applies to the EIZO monitor models: T68, TX-D7, F67 and FX-D7. Please note that there are some points which vary according to the model.

## Package Contents:

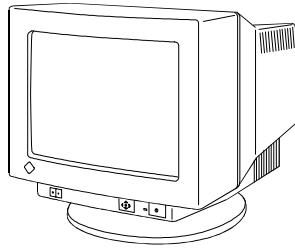

Monitor

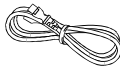

Power Cord

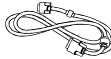

Signal Cable  
(MD-C87)



EIZO USB Cable  
(MD-C93)



Cleaning Cloth for  
CRT Screen



User's Manual



ScreenManager  
Quick Reference



Warranty  
Registration Card



EIZO FlexScan  
CRT Utility Disk

**NOTE**

- If any of the above-listed items are missing or damaged, please contact your local dealer for assistance.
- For information about Windows® 95/98 setup (Plug & Play), refer to the README in the EIZO FlexScan CRT Utility Disk.
- Connection to a Macintosh requires use of an optional Macintosh adapter. Please consult EIZO dealer.
- We recommend that you retain the original packing materials in case of future need.

# 1 INSTALLATION

## 1-1 Controls & Connectors

Front

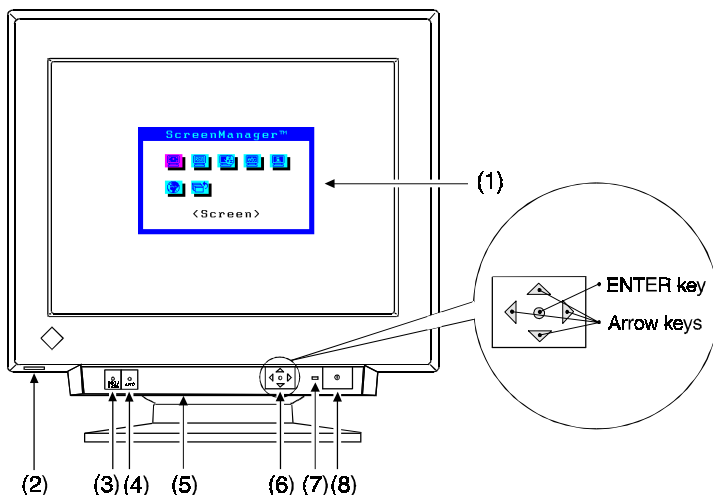

(1) ScreenManager menu

The ScreenManager is used to adjust the image of the monitor. Adjustments are made using the Control Pad (6) shown in diagram. See page 14 for further details.

(2) USB port with a drop down access lid (Downstream port x 1)

See page 44 for further details.

(3) BNC/D-SUB selection button

Selects BNC or D-Sub connector as active input. This feature is only used when two computers are connected to the monitor.

(4) AUTO-SIZING button

Automatically centers the displayed image, bringing the image borders into alignment with the monitor frame. See page 18.

(5) Power terminal covers for the optional *i*Sound sound unit

(6) QuickSet™ Control pad (hereinafter “Control pad”)

Use the four arrow keys and the ENTER key to enter adjustments and settings.

---

(7) Power indicator

Indicates the power-on status, as follows:

- Solid green: Power is ON (normal mode)
- Flashing green: PowerManager Mode 1 (power-saving mode)
- Yellow: PowerManager Mode 2 (maximum power-saving)

(8) Power switch

Switches the monitor's power ON and OFF.

## Rear

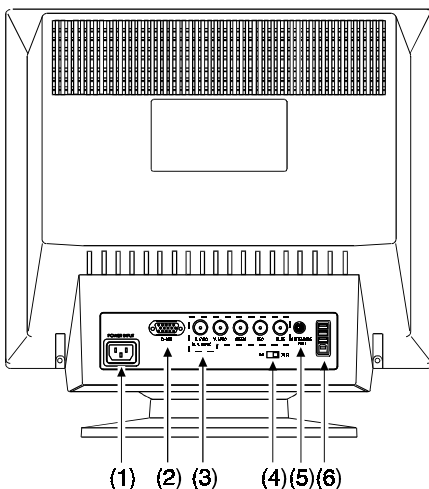

(1) Power connector

Use the supplied power cord only.

(2) D-Sub mini 15 pin input connector

(3) BNC input connector

(4) Termination switch

Allows multiple monitors to be chained together (Default termination is 75  $\Omega$ ).

(5) Maintenance port

Allows EIZO optional utilities to be attached.

(6) USB ports (Upstream port x1, Downstream ports x 3)

See page 44 for further details.

---

## 1-2 Connecting the monitor to the PC

- 1) Be sure that the power switches of both the PC and the monitor are OFF.
- 2) Plug the power cord into the power connector at the rear of the monitor. Then plug the other end of the cord into a power outlet.

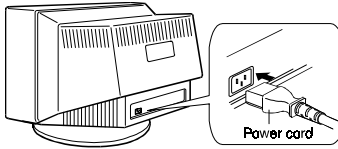

- 3) Plug the signal cable into the connector at the rear of the monitor.

### NOTE

- When connecting the signal cable or cable adapter, first check that the shape at the cable side matches the shape at the connecting side. After connecting, secure the connection with the screw-in fasteners.

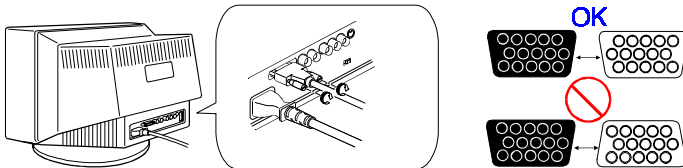

- 4) Plug the other end of the cable into the video connector on the rear of the PC. Refer to the figures below.

### Standard PC graphics board

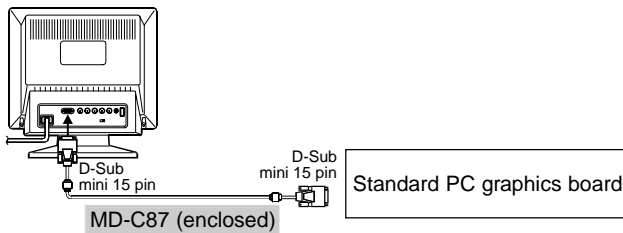

## Macintosh

You must connect an optional Macintosh adapter to the PC before connecting the signal cable.

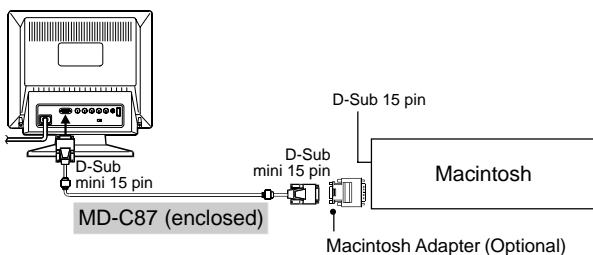

- 5) Turn on the monitor power first, then switch on the PC power. The monitor's power indicator (LED) will light up (green). The monitor will warm up briefly, then display an image. Whenever you finish your operation, turn off the PC and the monitor.

### NOTE

- If an image does not appear, make sure that all connections have been made properly. Refer to the "TROUBLESHOOTING" section on page 36 for additional advice.

## 1-3 Setting the resolution

The following look-up table shows the maximum (Non-interlaced) vertical refresh rates for this model with regard to **standard resolutions set forth by VESA**. The best way to see if the monitor will work with a given resolution and rate, is to compare the vertical refresh rate of the graphics board to the monitor's range (Refer to the graphics board manual for specifications). If the refresh rate is within the specified range of the monitor, it should operate properly.

Horizontal Scan Frequency (kHz)	Maximum Vertical Refresh rate (Hz)				
	640x480	800x600	1024x768	1280x1024	1600x1200
30-96	160	144	118	89	76

# 2 SCREEN ADJUSTMENT

## 2-1 How to use the ScreenManager

### ScreenManager Menu

ScreenManager consists of a main menu and six sub menus: “Screen”, “Color”, “PowerManager”, “Others”, “Information” and “Language.” Animated icons on each menu allow for easy adjustment.

#### Main menu

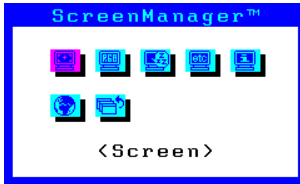





#### NOTE

- The menu message for the ScreenManager can be displayed in six languages: English, German, French, Italian, Spanish and Swedish. First, select the preferred language through the “Language” menu. This will become the default language when you use the ScreenManager.

#### Sub menus

Menus	Functions	Reference
	<p>&lt;Screen&gt;</p> <p>Brightness/Contrast, Horizontal/Vertical Size, Position, Side Pin-cushion/ Trapezoidal adjustment, Tilt, Uniformity, Convergence and Moiré Reduction.</p>	Page 19
	<p>&lt;Color&gt;</p> <p>Standard color with selection of color temperature and Custom color with adjustment of color tone.</p>	Page 23

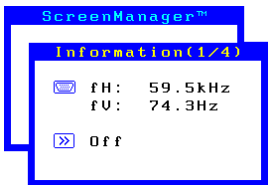
### Entering the ScreenManager

Menus	Functions	Reference
	<p>&lt;PowerManager&gt; Power saving settings.</p>	Page 28
	<p>&lt;Others&gt; Degauss, Input-signal priority selection for two signal connections, Beep ON/OFF, ScreenManager menu position, Contrast adjustment, Signal filter setting and Reset to defaults.</p>	Page 33
	<p>&lt;Information&gt; This menu shows the current ScreenManager settings. The menu contains four pages. Pressing the ENTER key displays the following information:</p> <ul style="list-style-type: none"> <li>• Page 1: Input port, horizontal and vertical frequencies, moiré reduction setting</li> <li>• Page 2: Color-adjustment settings</li> <li>• Page 3: PowerManager settings</li> <li>• Page 4: Input priority (see note), beep and Signal filter setting</li> </ul> <p><b>NOTE</b></p> <ul style="list-style-type: none"> <li>• The current ScreenManager setting is displayed even if the input selection has been manually overridden by the use of the BNC/D-Sub selection button.</li> </ul>	
	<p>&lt;Language&gt; First select the preferred language to use. Six languages are available to choose from: English, German, French, Spanish, Italian and Swedish. The ScreenManager's messages will appear in the selected language.</p>	

Press the ENTER key to display the ScreenManager Main menu.

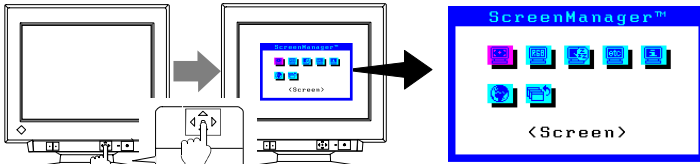

### Enter the Settings

Use the Control pad (the four arrow keys and the ENTER key) to make the required adjustments and settings.

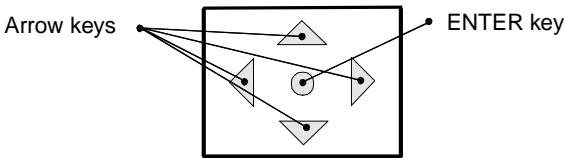

### Save & Exit

To return to the previous menu, select the Return icon (or push the “down” arrow key twice), then push the ENTER key.

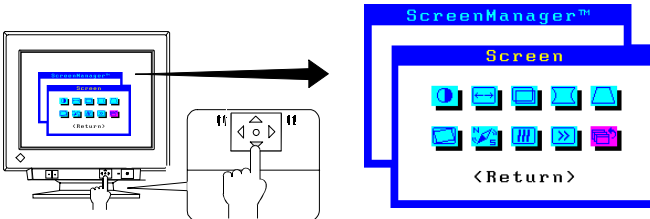

To save settings and exit the ScreenManager, select the Exit icon and press the ENTER key.

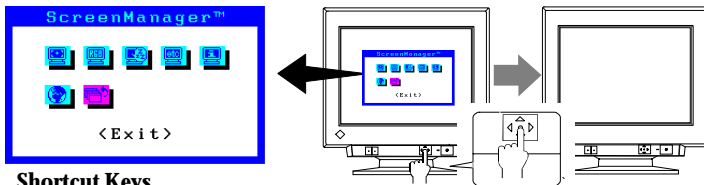

### Shortcut Keys



Before entering the ScreenManager, brightness and contrast can be adjusted directly by moving the Control pad. To record the new setting and exit the ScreenManager, press the Enter key. (The brightness and contrast functions are also available in the ScreenManager “Screen” menu.) See the diagram described below for adjustment directions.

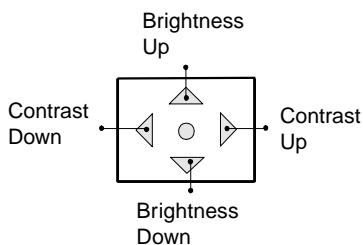
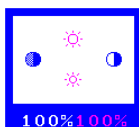

---

## 2-2 Imaging adjustment

### Using the AUTO-SIZING button

After connecting the monitor to the PC, first press the AUTO-SIZING button on the front panel. The AUTO-SIZING function centers the displayed image, aligning the image's borders with respect to the monitor frame.

In general, press the AUTO-SIZING button whenever changing the graphics board or the resolution or when image size and/or position is incorrect.

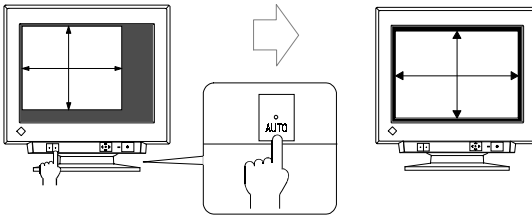

If further adjustment is required, adjust the picture size/position as desired using the Size/Position function in the ScreenManager "Screen" menu. Refer to the next page.

#### NOTE

- The AUTO-SIZING function is intended for use on Macintosh, and IBM compatibles running Windows. It may not work properly if either of the following applies:
  - An AT-compatible PC running MS-DOS (not Windows).
  - The background color for the "wallpaper" or "desktop" pattern is set to black.
- Some signals from the graphics board may not function properly.
- A solid-color screen (i.e. red, green, blue) may appear for an instant while performing the AUTO-SIZING function, this phenomenon is not a failure.

## - Screen menu -

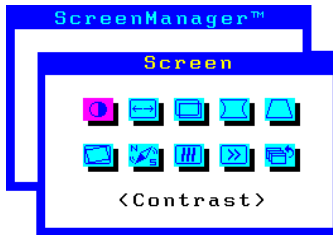

All of the icons shown in the ScreenManager “Screen” menu are described below.

### NOTE

- Allow the monitor to stabilize for at least 30 minutes before making image adjustments.

## Brightness, Contrast, Size, Position



These functions are used to adjust the brightness, contrast, size and position of the screen.



### Proper adjusting for brightness & contrast

- 1) Set the brightness and contrast to their maximum settings.
- 2) Set the display area to the minimum size. A black-and-white background (called a Raster) appears behind the display area.
- 3) Adjust the brightness so that the color of the Raster comes as close as possible to the color of the undisplayed area. This setting provides the sharpest contrast.
- 4) Restore the preferred display size either by pressing the AUTO-SIZING button or by adjusting the size and position via the ScreenManager menu.
- 5) Adjust the contrast as desired.

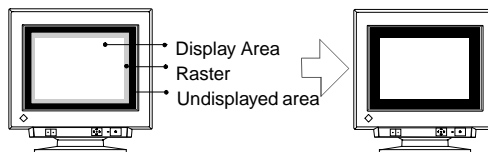

---

**NOTE**

- If you use the white text against a black background like DOS text, we recommend that you set the brightness to its maximum setting because the dark setting will result in eye strain due to high character contrast.

## Geometry, Tilt, Uniformity



Image distortion, tilting and/or the imbalance of brightness/whiteness over the entire screen may be caused by the Earth's magnetic field depending on the direction the monitor is facing.



Use the "Screen" menu's geometry (Side-Pincushion, Side-Pin Balance, Trapezoidal, Parallelogram) and tilt adjustment function to correct any geometric distortion and tilting.



The "Uniformity" adjustment function adjusts the bright/white uniformity in the corner of the screen. For adjustments, please follow the procedure below.

- 1) Degauss the screen by using the "Degaussing" function in the ScreenManager's "Others" menu.
- 2) Select the "Uniformity" function and adjust the screen so that the imbalance of brightness/whiteness over the entire screen will be minimized.
- 3) After performing the above adjustment, the screen image somewhat tilts. This can be corrected by using the "Tilt" adjustment function.

Image distortion, tilting and/or the imbalance of brightness/whiteness may also be caused by any device that generates a magnetic field. If the above adjustments are not effective, try the following approaches.

- Check to see if there are any nearby interfering electronic devices such as another monitor, an electric motor, or a speaker (other than an optional EIZO *i*-Sound speaker unit). If so, move the device or move the monitor.
- It is sometimes possible to correct distortion, tilting or the imbalance of brightness/whiteness by reorienting the monitor.

---

## Convergence



Displayed characters and images may appear fuzzy or have tinges of red, green, or blue if the electron beams do not converge correctly. These can be adjusted by the convergence adjustment feature in the ScreenManager.

### **What is convergence?**

Convergence is the monitor's ability to precisely illuminate specific phosphors and line them up properly in order to produce pure color.

In order to properly adjust convergence, it is best to have an image that makes it easy to see any convergence error. A black background with white letters or lines is the best. This could be a DOS text mode or an image created with a "paint" program.

When adjusting convergence, look at the adjustment across the whole screen. When adjusting horizontal convergence, look at the left and right edges of vertical lines or characters. When adjusting vertical convergence, look at the top and bottom edges of horizontal lines or characters. Proper adjustment is when the effect of red and blue tinges are minimized.

### **NOTE**

- The convergence adjustment adjusts the entire screen. It is not possible to limit adjustment to specific screen areas.

---

## Moiré Reduction



### What is moiré?

Moiré refers to an interference pattern of dark wavy lines on the screen. It is not a defect, but rather an interference phenomenon caused by the relationship between the phosphor layout and the imaging signal. Moiré is often an indication of a good focus level. Moiré is particularly noticeable when using a light-gray or every-other-dot pattern background. Although moiré can not be eliminated, it can be reduced with the moiré reduction feature.

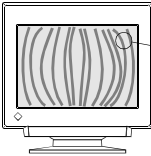

(Moiré)

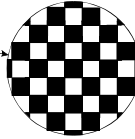

(Every-other-dot pattern)

Moiré can be reduced in a variety of ways.

- 1) Adjust with the ScreenManager's moiré reduction function.

Adjust so that moiré becomes almost unnoticeable. Before adjusting, set the desktop to an every-other-dot pattern (see picture above) so that moiré will be visible. Following the adjustment, change to a different desktop background to reduce moiré even further.

- 2) Change the horizontal and vertical dimensions.

Adjust the horizontal and vertical dimensions of the display area as necessary to reduce moiré.

- 3) Change the selected desktop or wallpaper pattern.

Use the PC software to change the desktop or wallpaper pattern. Any solid color pattern is recommended. For detailed information on how to change these patterns, refer to the documentation for the PC and operating system.

### NOTE

- The screen image may shake slightly while the ScreenManager moiré reduction function is ON. Switching the function OFF will improve image stability and clarity at the expense of slightly greater moiré.

## 2-3 Color Adjustment

### - Color menu -

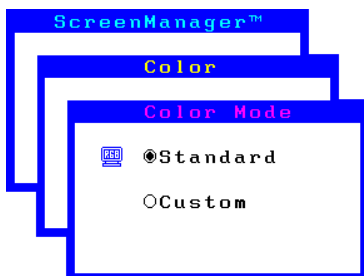

### Outline

EIZO monitors have incorporated two color adjustment mode, standard and custom. The “Standard” mode allows the adjustment of the color spectrum. The “Custom” mode allows extensive controls over the colors of the displayed image on the screen.

All adjustments for either mode can be made quickly and easily through the ScreenManager “Color” Menu - offering a tool to create customized color environment.

Please find the details of the color mode adjustment capabilities below:

Contents	Application
<p><b>Standard mode</b> Sets color temperature. Temperature can be set from 4000K to 10000K, in 500K increments. (Additionally, industry standard of 9300K is set as default.)</p>	For routine work and printing.
<p><b>Custom mode</b> Sets color temperature. Allows for specific adjustments to Red, Green and Blue (R/G/B). This consists of the Cutoff and Gain functions.</p>	For use when high precision color adjustment is necessary (i.e. when there is a need to obtain identical colors on multiple monitors* or match the display color with printout color**.)

\* The color adjustment spectrum may vary between monitors.

\*\* A color calibrator can be used for even higher-precision color adjustment.

---

**NOTE**

- Each monitor is slightly different, if two monitors are set to the same color temperature value (i.e. 6500K), they may not necessarily look the same.

## Adjusting the Standard mode

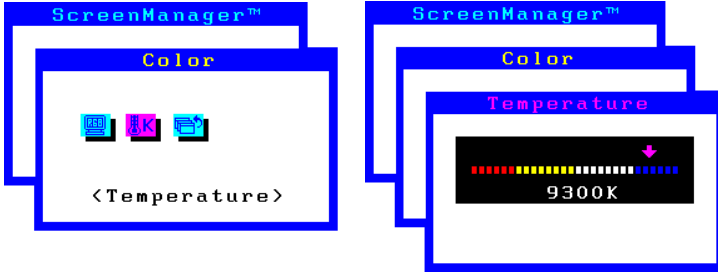
**NOTE**

- Users should allow at least 30 minutes for the monitor to stabilize before setting the color adjustments or color matching.

### Procedure

- 1) Go to the “Color” menu.
- 2) Select the “Standard mode” setting from the “Color mode” menu.
- 3) Select the “Temperature” icon. A color temperature bar will appear.
- 4) Adjust the temperature by using the right or left Arrow keys.
- 5) Press the ENTER key to save the data.

**What is color temperature?**

Color temperature is a method to measure the white color tone, generally indicated in degrees Kelvin. At high temperatures the white tone appears somewhat blue, while at lower temperatures it appears somewhat red. Computer monitors generally give best performance at high temperature settings.

5000K: Slightly reddish white. Often used in printing industry.

6500K: Warm-white tone, similar to white paper or daylight. This temperature is good for video-image display.

9300K: Slightly bluish white. This is the default setting for your EIZO monitor.



## Adjusting the Custom mode

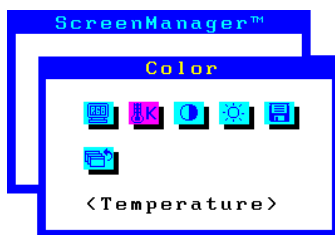

### Cutoff and Gain adjustments

Monitors use red, green and blue (R, G, and B) to convey color information. They use an additive method to combine different amounts of the primary colors to produce a desired color. In other words, monitors start with no light (black) and add percentages of red, green and blue to make colors. White is usually produced by adding the same amount of all three colors, where black is usually produced by adding no color.

However, colors are not only determined by the balance but also the intensities of R, G, and B (how bright they are) which we call Gain, and the saturation of R, G and B (how vivid or dull they are) which we call Cutoff.

### NOTE

- Users should allow at least 30 minutes for the monitor to stabilize before setting the color adjustments or color matching.
- Before you attempt to change the colors, always start with the color settings set to the “default settings” by using the “Reset” function in the ScreenManager “Others” menu.
- If only a quick setting is required, that is close to the desired color, but not exact, skip making any changes to the Cutoff adjustment (step 4). If a precise match is desired, adjustment of the Cutoff levels must be made. We recommend that for exact matching, use a color calibrator.

### Procedure

- 1) For optimum results, before beginning the custom color adjustment, go to the “Screen” menu and set the display to maximum brightness and contrast. (Use the “Screen” menu’s “Brightness” and “Contrast” icons.)
- 2) Then, return to the “Color” menu and select the “Custom mode” setting.
- 3) Set the color temperature.

- a) Select the “Temperature” icon from the sub menu.
- b) Select the temperature as desired by moving the arrow keys in any direction.

#### 4) Adjust the Cutoff

##### **Cutoff**

The Cutoff adjustment is the most powerful adjustment. It alters the starting point (the black level) and the ending point (the white level). If the Cutoff level for color is raised or lowered, black, white, and all levels between are raised or lowered by the same degree.

Before adjusting the Cutoff, it is best to display a screen with a black background (such as the DOS command screen).

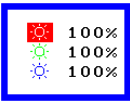

- a) Select “Cutoff” icon. The screen shown on the left will appear.
- b) Adjust each color until you can create a uniform black screen.

#### 5) Adjust the Gain

##### **Gain**

The Gain adjustment has no effect on the starting point (the black level). It changes only the ending point (the white level). The Gain adjustment is used to fine tune the whites and light grays to a good balance.

Before adjusting the Gain, it is best to display a screen image that has a white or grayscale background, such as the operating window for Windows.



- a) Select “Gain” icon. The screen shown on the left will appear.
- b) Adjust each color until you can create a uniform white screen.

6) To register the adjustment, select the “Save” icon and then press the ENTER key. If the settings are not saved, all adjustments will be lost.

7) Finally, readjust the contrast in the “Screen” menu to get the best image clarity.

##### **NOTE**

- If an inappropriate adjustment is made, corrections can be made by repeating the above procedure starting from Step 3 (temperature setting).
- The values shown in percentages (%) for both the Cutoff and Gain adjustments represent the current level within the specific adjustment only. They are available only as a reference tool. (To create a uniform white or black screen, the percentages for each will probably not be the same.)

- These diagram explains how the color curves were changed for the best adjustment in steps 4 and 5.

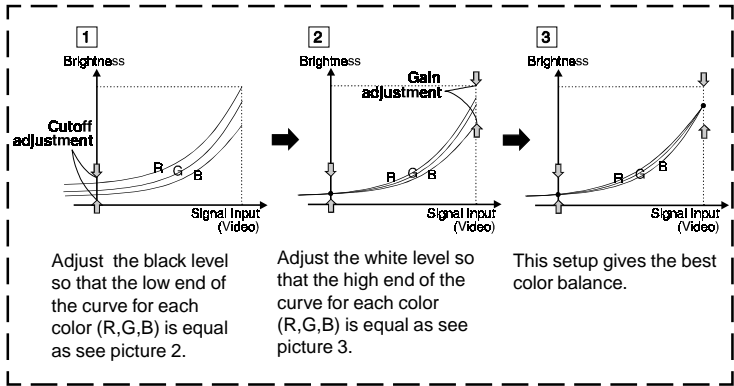

### What is the relation between the color and the brightness adjustment?

*Brightness* uniformly adjusts the amount of light output for the entire screen and its background. If it is increased too high the background will become white, too low and many dark colors will not be displayed. It affects all color controls.

*Contrast* varies the difference in light output from the lowest to the highest screen intensities. It is the brightness adjustment for the video signal area.

After making the color settings, readjust the contrast to get the best definition and intensity of the colors for the displayed image.

---

## 2-4 Power-save Setup

### - PowerManager menu -



#### What is PowerManager?

The PowerManager feature automatically reduces the monitor's power consumption during idle periods, in accordance with the PC's ScreenSaver software.

There are two PowerSaving modes in the EIZO PowerManager: Mode 1 and Mode 2. Even if the monitor is in a power saving mode, it will return to a normal display immediately when the mouse or keyboard is operated.

The EIZO PowerManager functions comply with NUTEK and VESA DPMS standard.

Power consumption:

Normal operation : 120 W

PowerManager Mode 1: less than 10 W \*  
(Power Indicator flashing green)

PowerManager Mode 2: less than 3 W \*  
(Power Indicator solid yellow)

\* When the USB hub is not connected



As an ENERGY STAR® Partner, EIZO NANA CORPORATION has determined that this product meets the ENERGY STAR® guidelines for energy efficiency.

#### NOTE

- Do your part to conserve energy, turn off the monitor when your finished using it. Complete energy use can only be stopped by disconnecting the monitor from the power supply.
- Even if the monitor is in a power saving mode, USB compliant devices function when they are connected to the monitor's USB (both the upstream and the downstream ports). Therefore, power consumption of the monitor will change according to the connected devices even if the monitor is in a power saving mode.
- When the monitor is in a power saving mode, the optional EIZO *i*-Sound speaker unit will turn off.

## Set-up Procedure

Set the monitor's power-save environment to match the PC's ScreenSaver software.

### NOTE

- For the PC setup, please refer to the user's manuals for the PC and graphics board.

There are two power-save settings for the monitor.

"VESA DPMS" system works with the VESA DPMS signal.

"NUTEK"s system works with a screen saver software and Energy Saver for Macintosh which blanks the screen (totally black screen).

Set the monitor to match the PC's power-saving software, as follows.

### Monitor setting for matching the PC:

PC	PC Power saving	Monitor setting
PC/AT and compatibles (VESA DPMS activated)	VESA DPMS (Signal)	VESA DPMS
PC/AT and compatibles (VESA DPMS inactivated)	Windows (Control Panel/Desktop/ ScreenSaver: "Blank Screen")	NUTEK
Macintosh	Energy Saver	NUTEK
	ScreenSaver software After Dark/"Blank" settings	NUTEK

## VESA DPMS System

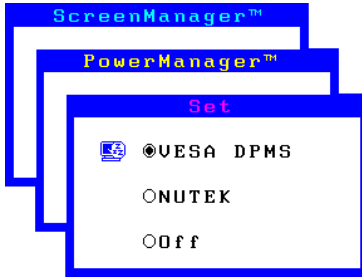

- 1) First, make the appropriate settings for the PC. (See note, page 29.)
- 2) Then select "VESA DPMS".
- 3) Set the delay period, which is the interval that the monitor will wait after receiving a power-save signal from the PC, before entering into Mode 1 or Mode 2.

### VESA DPMS power-saving method

VESA DPMS utilizes four signals: ON, STANDBY, SUSPEND, and OFF. The monitor detects these signals from the graphics board and executes power-saving accordingly, as illustrated below.

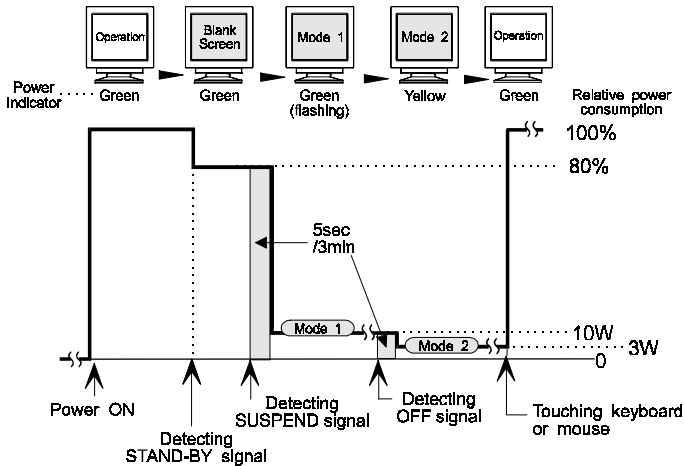

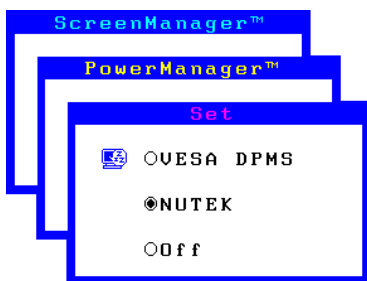

## NUTEK System



1) First make the appropriate ScreenSaver settings (Macintosh/Energy Saver) for the PC.

2) Then select “NUTEK”.

 3) Set the delay time, which is the interval between the time that the ScreenSaver (Macintosh/EnergySaver) blanks the screen and the time that the monitor enters Mode 1.

 4) Set the Mode 1 duration time which is the user definable time (0-60 minutes) before the monitor enters Mode 2.

### NUTEK power-saving method

Mode 1 operates for a user-definable period in “Duration” (in 0-60 minutes) before the monitor enters Mode 2. If the keyboard or the mouse are not in use during this period, the monitor will then enter PowerManager Mode 2.

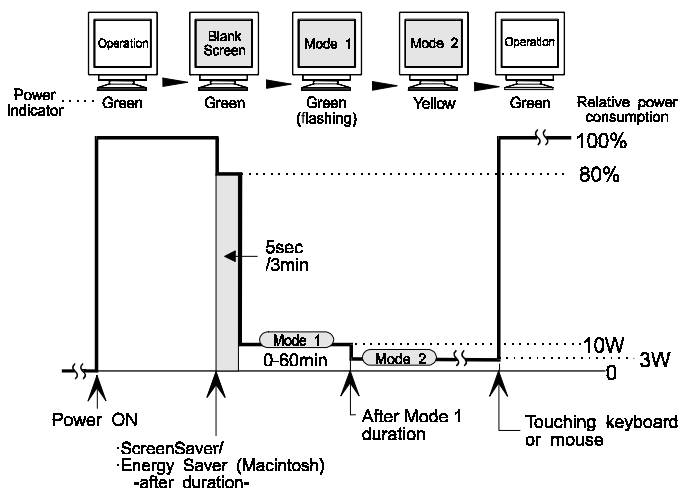

---

**What is VESA DPMS?**

The acronym VESA stands for “Video Electronics Standards Association,” and DPMS stands for “Display Power Management Signaling.” DPMS is a communication standard that PCs and graphics boards use to implement power savings at the monitor side.

**What is NUTEK?**

NUTEK is the acronym for the Swedish National Board for Industrial and Technical Development, an organization that works to promote power-saving technologies.

**What is ENERGY STAR?**

“ENERGY STAR” is a set of power-saving guidelines issued by the U.S. Environmental Protection Agency (EPA). The guidelines apply to PC systems and peripherals.

**AutoPower Function**

Once the monitor’s main power has been switched ON, the monitor will start up automatically whenever the PC is turned on. If the PowerManager is set to VESA DPMS or NUTEK, the monitor will automatically power down (to PowerManager Mode 2) when the PC is turned off. If the PowerManager is set to OFF, however, the monitor power will remain on even after the PC is switched off.



## 2-5 Other Settings

### - Others menu -



All of the icons shown in the ScreenManager “Others” menu are described below.

### Degaussing



The monitor automatically degausses every time the power is turned ON and every time it is reactivated from the PowerManager power-saving Mode 2. A degaussing function is provided in the ScreenManager for use at other times. Note that the image vibrates slightly while degaussing is in progress, but will return to normal when degaussing is completed.

#### NOTE

- The degauss circuitry takes about 30 minutes to regain maximum power following degaussing before it can work again.

#### What is degaussing?

“Degaussing” refers to the process of removing magnetic-field effects from the monitor. Operation of the monitor within a magnetic field may adversely effect color purity. Degaussing can be used to correct the problem.

### Input Priority



This function is used to select which PC will have priority to control the monitor when utilizing two PCs.

There are three settings available: “D-Sub”, “BNC” or “Manual”. The default priority setting is “D-Sub”.

The monitor constantly checks the input signals and switches automatically in accordance with the “Input Priority” settings (see chart on next page). Once a priority is set, whenever a change of signal is detected at the selected input, the monitor will switch the input to that signal.

In the case of only one signal being present at either input, the monitor automatically detects and displays that signal.

Priority setting	Performance
D-Sub	If signals from both inputs are present, the monitor gives preference to D-Sub for the cases shown below: <ul style="list-style-type: none"> <li>• When the power of the monitor is turned ON (see note 1).</li> <li>• When the signal input to D-Sub is changed even if active input was BNC.</li> </ul>
BNC	If signals from both inputs are present, the monitor gives preference to BNC for the cases shown below: <ul style="list-style-type: none"> <li>• When the power of the monitor is turned ON (see note 1).</li> <li>• When the signal input to BNC is changed even if active input was D-Sub.</li> </ul>
Manual	The monitor will not detect signals automatically in this mode. Select the active input by pressing the input signal selection button on the monitor's front panel.

**NOTE**

- 1 The Input Priority function does not automatically reactivate when the monitor has been in the power save mode.
- 2 The Input selection button on the front panel can be used to select either D-Sub or BNC as the active input at any time.

**Beep**



Use this feature to set the beeper ON or OFF. If the beeper is ON, the monitor will generate beep signals as shown below. If the beeper is OFF, the monitor will not beep.

Short beep	<ul style="list-style-type: none"> <li>• ScreenManager item selected.</li> <li>• ScreenManager parameter adjusted to minimum or maximum limit.</li> <li>• BNC/D-Sub selection button pressed.</li> </ul>
Long beep	<ul style="list-style-type: none"> <li>• AUTO-SIZING button pressed.</li> <li>• ScreenManager data-save executed.</li> </ul>
Four short beeps	<ul style="list-style-type: none"> <li>• Monitor not connected correctly.</li> <li>• PC turned off.</li> <li>• Monitor received unsupported signal frequency.</li> </ul>

---

## Menu Position, Menu Contrast



Use these functions to adjust the position and contrast of the ScreenManager menu. The menu contrast can be set from level 0 (minimum setting) to 5 (maximum setting).

## Signal Filter



This monitor provides two display modes according to the characteristics of each graphics board for displaying the image properly. If the characteristics of the graphics board does not match those of the monitor, the characters and images displayed may have a slight shadow on their right side (refer to figure below). If this phenomenon is noticeable, use the “Signal Filter” function. Select either mode 1 or mode 2, whichever displays the image better.

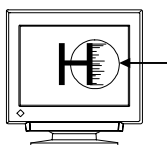

## Reset



Use this function to return all ScreenManager parameters (size, position, geometry, color, PowerManager etc.) to their factory default settings. Default settings are as follows.

- Screen: Moiré = OFF
- Color: Standard/9300K
- PowerManager: VESA/5 sec.
- Others: Input Priority = D-Sub  
Beep = ON  
Signal Filter = Mode 1
- Language: English

# 3 TROUBLESHOOTING

## 3-1 Troubleshooting

This page presents problems that can be corrected by the user. If a problem persists even after applying the suggested remedies, contact an EIZO dealer.

### ■ Problems caused by incorrectly setting of the termination switch

Problems	Points to check with possible solutions
1) Misconvergence of colors.	<ul style="list-style-type: none"><li>• The termination switch on the rear of the monitor should be set to 75 Ω position (default) for connection to a single monitor.</li></ul> <p>If it is set to the ∞ position when using a single monitor, some problems like 1) ~ 4) may occur.</p> <p>Check that the switch position is set to 75 Ω position.</p>
2) Focus is dull.	
3) PowerManager does not work properly in VESA setting.	
4) Slight shadow appears on the edges of the screen image or text. (only for the BNC connections.)	

### ■ No picture

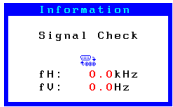
Problems	Points to check with possible solutions
1) Indicator status: OFF 2) Indicator status: GREEN 3) Indicator status: YELLOW	<ul style="list-style-type: none"><li>• Check that the power cord is correctly connected.</li><li>• Try pressing a key on the keyboard, or clicking the mouse. (The screen-saver software may be active.)</li><li>• Check brightness and contrast settings. Minimum settings will cause screen to be blank.</li><li>• Try pressing a key on the keyboard, or clicking the mouse. (The screen-saver software may be active.)</li></ul> <p>If the problem persists, switch off the monitor power for a few minutes, then switch it back on and try again.</p>
4) “No signal detected” error message appears. 	<ul style="list-style-type: none"><li>• Check that the PC is switched ON.</li><li>• Check that the signal cable is properly connected to the graphics board or PC.</li><li>• Check that the graphics board is correctly inserted in the PC.</li><li>• Switch the signal input by pushing the BNC/ D-Sub selection button on the front control panel.</li></ul>

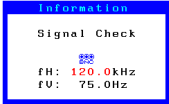
Problems	Points to check with possible solutions
5) “Out of range” error message appears. (Example) 	<ul style="list-style-type: none"> <li>• Use the graphics board’s utility software to change the frequency setting. (Refer to the manual of the graphics board.)</li> <li>• Whenever an error signal message appears, the signal frequency will be displayed in red.</li> </ul>
<div style="border: 1px solid black; padding: 5px;"> <p><b>NOTE</b></p> <ul style="list-style-type: none"> <li>• Error messages will remain on the screen for 30 seconds, and then disappear. An error message may not appear at all if the signal frequency is extremely high or extremely low.</li> </ul> </div>	

### ■ Imaging problems

Problems	Points to check with possible solutions
1) Display size and/or position is incorrect.	<ul style="list-style-type: none"> <li>• Press the AUTO-SIZING button on the front panel. See page 18.</li> <li>• Adjust the image size and/or position using the icons in the ScreenManager “Screen” menu. See page 19.</li> </ul>
2) The screen is partially dark.	<ul style="list-style-type: none"> <li>• The CRT is not warmed up. Allow 30 minutes for the monitor to stabilize.</li> <li>• Degauss the screen. (Use the degaussing feature in the ScreenManager’s “Others” menu. See page 33.)</li> <li>• This problem can be caused by the earth’s magnetism. Adjust the uniformity in the ScreenManager’s “Screen” menu. See page 20.</li> </ul>
3) The entire screen is dark.	<ul style="list-style-type: none"> <li>• Adjust the contrast and brightness using the ScreenManager’s “Screen” menu. See page 19.</li> <li>• Some signal timings can be the cause of this problem. To correct this, turn off the monitor, then hold down the AUTO-SIZING button and “down” arrow key while turning on the monitor again. This will change the signal timing and brighten the screen. If the above operation is repeated, the screen becomes dark again.</li> </ul>

Problems	Points to check with possible solutions
<p>4) • The image vibrates on the screen.</p> <p>• A slight shaking movement of the screen image or text.</p>	<ul style="list-style-type: none"> <li>• Use of the “Moiré Reduction” feature may cause a slight vibration. To eliminate the vibration, switch the feature OFF or reduce the moiré reduction level. See page 22.</li> <li>• Check that the signal cable is properly connected to the graphics board or PC.</li> <li>• Check that the graphics board is correctly mounted in the PC.</li> <li>• The signal cable might be damaged. Please contact the dealer.</li> <li>• The monitor may be located close to a device that is generating a magnetic field. Such devices include speakers (other than the EIZO optional <i>i</i>Sound speaker), electric motors, high-voltage cables, and other monitors. It may be solved by switching off or moving the interfering device, or by relocating the monitor.</li> <li>• If the volume level of the EIZO optional <i>i</i>Sound speaker is too high, it may, in some cases, cause a slight vibration. To eliminate, turn down the volume of the speaker.</li> </ul>
<p><b>NOTE</b></p> <ul style="list-style-type: none"> <li>• A unstable signal from the graphics board may be the cause of the imaging problem 2) when using the monitor with a high resolution or in a high refresh mode. (The video signal from the graphics board might be made irregular due to the use of a high speed dot clock.) Change the resolution or the refresh rate to another setting.</li> </ul>	
<p>5) The image has a background shadow.</p>	<ul style="list-style-type: none"> <li>• Try adjusting the convergence in the ScreenManager’s Screen menu. See page 21.</li> <li>• This problem can occur when using BNC connection and the termination switch is set incorrectly. The termination switch should be set to 75 Ω for a connection to a single monitor. See page 11.</li> </ul>
<p>6) The characters and images have a slight shadow on their right side.</p> 	<ul style="list-style-type: none"> <li>• Change the mode of “Signal Filter” function in the ScreenManager “Others” menu. See page 35.</li> </ul>

Problems	Points to check with possible solutions
7) Moiré patterns are distracting. 	<ul style="list-style-type: none"> <li>Go to the ScreenManager's "Screen" menu. Switch on the moiré reduction feature and adjust as necessary. See page 22.</li> </ul>
8) The image is flickering.	<ul style="list-style-type: none"> <li>Flicker will occur with interlaced scanning, or non-interlaced scanning with a low refresh rate. All EIZO monitors are capable of reproducing high refresh rates for non-interlaced scanning. If a problem occurs when using a non-interlaced signal, try adjusting the graphics board to increase the refresh rate (if possible). Refer to the graphics board manual for information.</li> </ul>

#### Non-Interlaced / Interlaced

In a "non-interlaced" scan, the electric guns draw the entire image in one vertical pass, with each pass covering every horizontal line.

In a "interlaced" scan, the guns draw the entire image by scanning vertically twice. At the first scanning, the guns draw every other horizontal line. At the second, they draw the other lines. Thus, in a "interlaced scan", the image flickers more visibly when compared with a "non-interlaced" scan.

#### Flicker

The term "flicker" refers to noticeable shimmering that occurs when the image on the screen is redrawn ("refreshed") too slowly. A refresh rate of 80 Hz means the image is redrawn 80 times per second. Most people will notice flicker at image refresh rates as high as 60 or 70 Hz, whereas refresh rates of 72 Hz or above usually is not noticeable. Flicker is known to be the cause of visual fatigue.

### ■ Color problems

Problems	Points to check with possible solutions
1) The entire screen appears bluish or reddish.	<ul style="list-style-type: none"> <li>The CRT is not warmed up. Allow 30 minutes for the monitor to stabilize.</li> </ul>
2) Color purity is not uniform.	<ul style="list-style-type: none"> <li>Allow 30 minutes for the monitor to warm up.</li> <li>Degauss the screen. (Use the degaussing feature in the ScreenManager's "Others" menu. See page 33.)</li> </ul>

Problems	Points to check with possible solutions
3) Misconvergence of colors. (red, green, blue) 	<ul style="list-style-type: none"> <li>• Allow 30 minutes for the monitor to warm up.</li> <li>• Adjust the convergence using the Convergence feature in the ScreenManager's Screen menu. See page 21.</li> <li>• This problem can occur when using a BNC connection and the termination switch is set incorrectly. The termination switch should be set to 75 Ω for connection to a single monitor.</li> </ul>



#### Explanation of the Characteristics of CRTs

When the monitor is not fully warmed up, the screen may look slightly colored, e.g. reddish or bluish. This phenomenon is due to the unstableness of the electron gun during its warm-up period. Please wait for about 30 minutes until the monitor stabilizes in order to gain its proper color.

#### ■ Others

Problems	Points to check with possible solutions
1) The monitor beeps or hums.	<ul style="list-style-type: none"> <li>• The monitor emits a humming noise when executing automatic degaussing at power-ON. This is not a problem.</li> <li>• The monitor beeps at any time. This is not a problem. See page 34 for full details.</li> </ul>
2) Control Pad "ENTER key" does not operate.	<ul style="list-style-type: none"> <li>• The Adjustment Lock is probably on. To unlock: switch off the monitor power, then hold down the AUTO-SIZING button and switch the monitor back on. See page 43.</li> </ul>
3) AUTO-SIZING button does not operate.	<ul style="list-style-type: none"> <li>• The Adjustment Lock is probably on. To unlock: switch off the monitor power, then hold down the AUTO-SIZING button and switch the monitor back on. See page 43.</li> </ul>
4) AUTO-SIZING button does not work properly.	<ul style="list-style-type: none"> <li>• The Auto-sizing function is intended for use on the Macintosh and on IBM compatibles running Windows. It may not work properly if either of the following applies.               <ul style="list-style-type: none"> <li>- You are running an AT-compatible PC on MS-DOS (not Windows).</li> <li>- The background color for the "wallpaper" or "desktop" pattern is set to black.</li> </ul> </li> <li>• Some signals from graphics boards may not function properly.</li> </ul>



Problems	Points to check with possible solutions
<p><b>NOTE</b></p> <ul style="list-style-type: none"> <li>A solid-color screen (i.e. red, green, blue) may appear for an instant while performing the auto-sizing function, this phenomenon is not a failure.</li> </ul>	
<p>5) Characters are too large.</p> <div style="display: flex; justify-content: space-around; align-items: center;"> <div style="text-align: center;">  <p>Low resolution</p> </div> <div style="text-align: center;">  <p>High resolution</p> </div> </div>	<ul style="list-style-type: none"> <li>Change the resolution of the graphics board to a higher setting. (Refer to the manual for the graphics board or PC.)</li> </ul>

### What is Resolution?



*Resolution* is expressed as the number of dots (pixels) displayed on the screen. A larger number of dots produces a more sharply defined (a higher-resolution) image.

Note that for a given screen size the dot size decreases as the number of dots increases: a 640 × 480 (dot × line) resolution uses larger pixels than a 1024 × 768 resolution. The display size of a given font therefore varies according to the resolution. Higher resolutions allow you to display more information on the screen.

### Changing the resolution

If you are using a Macintosh, you can change the resolution from the APPLE menu by selecting "Option" from "Monitor" or "Sound & Display." If you are using a PC other than a Macintosh, refer to the manual for your PC or graphics board for information. Please refer to both the graphics board and monitor manuals for the scanning frequency compatibility.

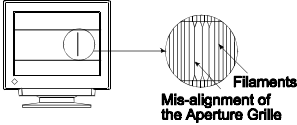
Problems	Points to check with possible solutions
<p>6) Two horizontal hairlines are visible on the screen. (only T68)</p>	<ul style="list-style-type: none"> <li>These are dampening wires. Dampening wires are used to support the CRT's aperture grille, and are visible as thin dark lines across the screen. All EIZO aperture-grille type CRTs include two such horizontal wires.</li> </ul> <p>The aperture grille itself is a grid of taut metal filaments that spans the entire screen from top to bottom.</p>

Problems	Points to check with possible solutions
<p>7) Faint black vertical lines are visible on the screen. (only T68)</p>  	<ul style="list-style-type: none"> <li>The aperture grille may be misaligned. Shock or vibration during transport may, in some cases, cause the aperture grille to fall out of alignment. The problem will appear as one or more faint black lines across the screen.</li> </ul> <p>If this problem occurs, it may be able to solved by:</p> <ul style="list-style-type: none"> <li>degaussing the screen, or</li> <li>lightly tapping (do not hit) the side of the monitor.</li> </ul> <p>If neither of these methods works, try executing the following procedure.</p> <ol style="list-style-type: none"> <li>Display a bright white field over the area where the black line(s) appear, with a black field over the unaffected areas. (Do this by opening a bright-white window on top of a black desktop or wallpaper background. Position the window so that it just covers the area of misalignment.)</li> <li>Set brightness and contrast to maximum values, and keep the display ON until the problem is corrected. Try tapping the side of the display lightly to help expedite realignment. The white field will heat up the misaligned area of the grille, returning it to proper alignment.</li> </ol>

**NOTE**

- For problems with the USB function, refer to the troubleshooting on page 47.

# 4 GETTING THE MOST FROM YOUR MONITOR

## 4-1 Adjustment Lock

The ScreenManager operation can be disabled by holding down the AUTO-SIZING button while switching on the monitor's power. This will disable ("lock") the ScreenManager and AUTO-SIZING button, protecting from accidental changes.

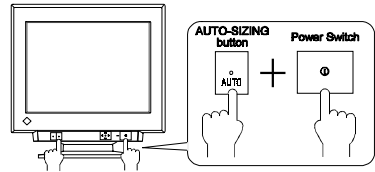

To unlock the buttons: switch the power off, then hold down AUTO-SIZING button once again and turn the power back on.

Note that brightness and contrast can be adjusted using the short cut keys (see page 17) even while the Control pad is locked. After making such an adjustment, push the ENTER key to clear the brightness/contrast adjustment menu from the screen. Also, the BNC/D-Sub Selection button can still be used.

## 4-2 Connecting two PCs to the Monitor

(Example)

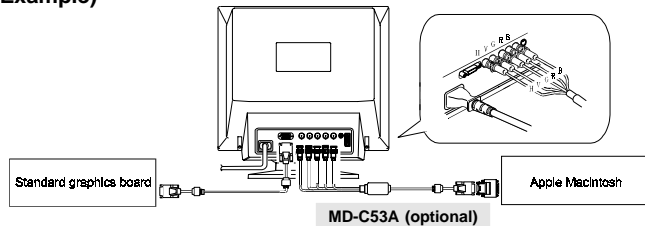

Connect one PC to the monitor's D-Sub connector and another to the BNC connector. The BNC connection should be made with an EIZO BNC cable, available as an option.

### NOTE

- Be sure that the monitor and the PC are both switched off before connecting them.
- Be sure to connect the cable securely.

## Selecting the active input

- The BNC/D-Sub selection button on the front panel can be used to select either BNC or D-Sub connection as the active input.
- The ScreenManager's "Input Priority" setting (in the "Others" menu) can be used to set up the automatic selection of the input. See page 33 for details.

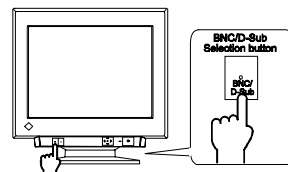

---

### 4-3 Optional *i-Sound* Sound Unit

The optional speaker system *i-Sound* connects directly to the monitor and can be used to support multimedia applications. The unit includes a microphone function. For details, consult EIZO dealers.

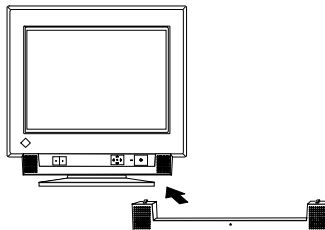

### 4-4 Making use of USB (Universal Serial Bus) - For USB compliant system environments-

This monitor provides a hub which supports the USB standard. When connecting to a USB compliant PC or another hub, the monitor functions as a hub to which the USB compliant peripherals can be connected. The USB standardized connectors enable the easy connection with these peripherals. As an added advantage, the monitor can be controlled from a PC with a mouse or keyboard when utilizing the enclosed utility software "ScreenManager Pro for USB".

#### **NOTE**

- To utilize the USB hub function, the following system environment is required.
  - PC equipped with USB ports or another USB hub connected to the USB compliant PC
  - OS (Windows 98)/Mac OS 8.5.1 or newer
  - EIZO USB cable (MD-C93, enclosed)
- The USB hub function may not work properly with some systems. Please consult the manufacturer of each system for details about this feature.
- When the monitor is not on, the peripherals connected to the downstream ports will not operate.
- Even if the monitor is in a power saving mode, USB compliant devices will function when they are connected to the USB ports (both the upstream and the downstream) of the monitor.

### Monitor USB Function Setup

Before the setup, connect the monitor to the PC with the signal cable (see page 12) and boot the PC.

#### **(For Windows 98)**

- 1) Insert the "EIZO FlexScan CRT Utility Disk" into the floppy disk drive.
- 2) Connect the upstream port of the monitor to the downstream port of the USB compliant PC or another hub using the EIZO USB cable (MD-C93).

**NOTE**

- When connecting the USB cable, check that the shape of the connector at the USB cable side matches the shape at the connecting side.

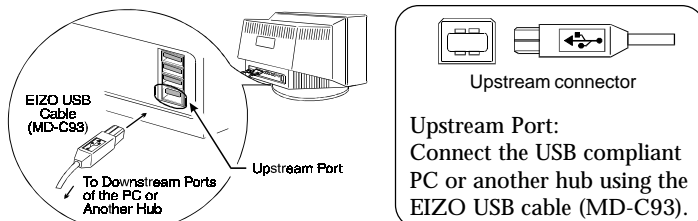

- (3) "EIZO USB Hub" appears on the screen. Insert the Windows 98 CD-ROM and click "OK" in the "Insert Disk" window. Follow the instruction of the window.
- (4) After the setup of the USB Hub, "Add New Hardware Wizard" window appears on the screen, and "Unknown Device" is detected.
- (5) Click the "Next" button.
- (6) Select the "Search for the best driver for your device (recommend)" button, and click the "Next" button.
- (7) Select the "Floppy disk drivers" and click the "Next" button.
- (8) "EIZO USB Monitor" appears on the screen. Follow the instruction of the window.

Once the above operation is completed, the monitor functions as a USB hub and the USB compliant peripherals can be connected to the downstream ports of the monitor.

**NOTE**

- Please refer to the readme.txt file for setup, too. Please make sure if the proper installation is completed by following the confirmation below.  
(Confirmation of USB Setup)
  - (1) Click the "Start" button and open the "Control Panel" from the "Settings".
  - (2) Select and double click the "System" from the "Control Panel" to open the "System Properties".
  - (3) Confirm if the followings are in the "Device Manager" window: "EIZO USB Hub" and "EIZO USB Monitor" appear under "Universal serial bus controller".
 The two points indicated that the settings were properly installed.

**(For MacOS 8.5.1 or newer)**

There is no need to install any software to utilize the USB hub function when connecting a USB compliant PC (or another USB hub) with the USB cable (MD-C93).

Connect the USB compliant peripherals to the downstream ports of the monitor:

(Example of connection)

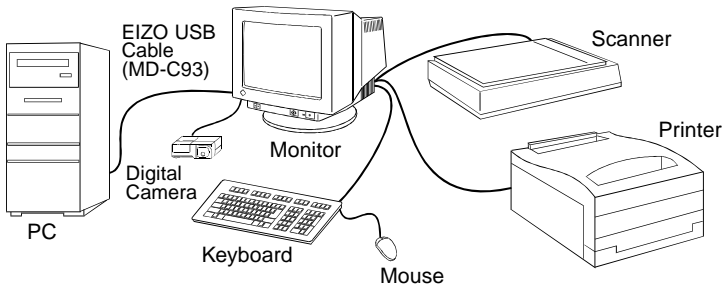

Front port (Example)

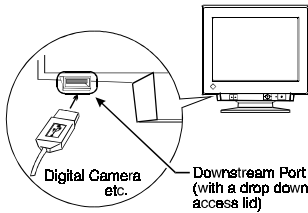

Rear port (Example)

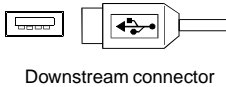
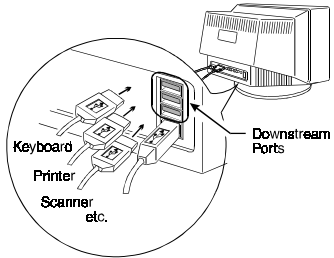

Downstream ports:  
Connect the cables from USB compliant peripherals such as a mouse, keyboard, etc.

## USB Specifications

USB standard	Rev. 1.0 complied self-powered hub
Downstream power supply	500 mA for each (Max.)
Communication speed	12 Mbps (full), 1.5 Mbps (low)
USB ports	Upstream port x 1 Downstream ports x 4

## Troubleshooting

Problems	Points to check with possible solutions
1) • USB function cannot be setup.	<input type="checkbox"/> Check that the USB cable is correctly connected. <input type="checkbox"/> Check that the PC and OS is compliant to the USB. (For the USB support of the system, consult the manufacturer of each system.) <input type="checkbox"/> Check the PC's BIOS setting for the USB. (For details, refer to the manual of the PC.)
2) • PC is hung up. • The peripherals connected to the downstream ports do not operate.	<input type="checkbox"/> Check that the USB cable is correctly connected. <input type="checkbox"/> Check the downstream ports by connecting the peripherals to other downstream ports. If the problem is solved by doing this, contact an EIZO dealer. <input type="checkbox"/> Try executing the following method. <ul style="list-style-type: none"> <li>• Restarting the PC</li> <li>• Connecting the PC and peripherals directly</li> </ul> If the problem is solved by doing this, contact an EIZO dealer. <input type="checkbox"/> The power button of the APPLE keyboard does not operate if it is connected to the EIZO USB Hub. Please connect the keyboard directly to the PC. Refer to the instruction of the PC for details.

### ScreenManager Pro for USB (for Windows 98)

The utility software “ScreenManager Pro for USB” is included in the enclosed utility disk. It is used for controlling the EIZO monitor from a PC using a mouse or keyboard. It allows control of the screen adjustment (size, position, distortion, color, contrast, moiré, etc.) from the familiar OS environment. Also, the adjusted screen data and the color data can be stored as the data files in the PC.

#### NOTE

- For information about ScreenManager Pro for USB setup, refer to the readme file, too.
- When using this program, the monitor must be connected to a USB compliant PC (OS) or another hub with the EIZO USB cable (enclosed). For instructions, please refer to the previous page.

To set up the “ScreenManager Pro for USB”, execute the “setup.exe” program in the “apps” directory of the “EIZO Utility Disk” and follow the procedure displayed on the screen. When the setup is completed, the “EIZO” tab is added in the “Display Properties” window and the monitor control function is available.

For details of the program, please refer to the Help menu in the program.

# 5 CLEANING

---

## WARNING

---



- **Keep liquids away from the monitor.**

Spillage into the cabinet may result in fire, electric shock, or equipment damage.

If an object or liquid falls/spills into the cabinet, unplug the monitor immediately. Have the unit checked by a qualified service engineer before using it again.

Using the monitor in this condition could cause serious injury or equipment damage.

## CAUTION

---

- **To ensure safety, always unplug the monitor before cleaning it.**  
Failure to do so may result in electric shock.
- **Periodically clean the area around the plug.**  
Buildup of dust, water, or oil on the plug may result in fire.
- **Never use thinner, benzene, or other strong solvents or abrasive cleaners, as these may cause damage to the cabinet or CRT.**



Periodic cleaning is recommended to keep the monitor looking new and to prolong its operational lifetime. Clean the cabinet and CRT areas as follows.

### Cabinet

To remove stains, wipe the cabinet with a soft, lightly moistened cloth using a mild detergent. Do not spray wax or cleaner directly onto the cabinet. Do not clean with compressed air.

### CRT Surface



The monitor comes with a special cloth specifically designed to remove fingerprints and dust from the screen. The cloth is washable, and will remain effective regardless of the number of times it is washed. If the supplied cloth is not available, you can clean the CRT surface with gauze, cotton, or lens paper.

If necessary, stubborn stains can be removed by moistening part of a cloth with water or alcohol (ethanol, methanol, or isopropyl alcohol) to enhance its cleaning power.



# 6 SPECIFICATIONS

## T68/TX-D7

**E**

### Electrical Specifications

CRT	50 cm (19 inch) class, 90° deflection Aperture Grille type CRT with Anti-Reflective SuperErgoCoat®
CRT AG Pitch	0.25 mm (center), 0.27 mm (edges)
Scan Frequency	
Horizontal:	30 kHz-96 kHz (Automatic)
Vertical:	50 Hz-160 Hz (Automatic)
Max. Active Display Area	362 mm (H) × 271 mm (V) (14.2" (H) × 10.7" (V)) (Viewable image size: 452 mm (17.7")) * Display size can be set by the user through microprocessor control panel. * The actual size displayed can be dependent on the graphics board or PC utilized.
Power Supply	100-120/220-240 VAC±10%, 50/60 Hz, 1.6/0.8 A
Power Consumption	
Normal/Max:	120 W/155 W (with EIZO optional speaker & USB attached)
PowerManager Mode 1:	Less than 10 W *
PowerManager Mode 2:	Less than 3 W * (* When the USB hub is not connected)
Input Connector	D-Sub mini 15-pin and BNC × 5 (switchable)
Recommended Resolution	1280 dots × 1024 lines
Input Signal	
Sync:	<ul style="list-style-type: none"><li>• H/V Separate, TTL, Positive/Negative</li><li>• H/V Composite, TTL, Positive/Negative</li><li>• Sync on Green 0.3 Vp-p, Negative</li><li>• Analog 0.7 Vp-p/75 Ω, Positive</li></ul>
Video:	

### Mechanical Specifications

Dimensions	452 mm (W) × 455 mm (H) × 478 mm (D) (17.8" (W) × 17.9" (H) × 18.8" (D))
Weight	26.5 kg (58.4 lbs.)

### USB Specifications

USB standard	Rev. 1.0 complied self-powered hub
Downstream power supply	500 mA for each (Max.)
Communication speed	12 Mbps (full), 1.5 Mbps (low)
USB ports	Upstream port x 1, Downstream ports x 4

### Environmental Specifications

Temperature	operating: 0°C to 40°C (32 °F to 104 °F) storage: -20°C to 60°C (-20 °F to 140 °F)
Humidity	30% to 80% R.H. Non-condensing

### Certifications and Standards

100-120 VAC range	UL/CSA, FCC-B, DHHS, TÜV Rheinland/Ergonomics Approved, TCO'99, EPA Energy Star® Program
220-240 VAC range	CE, CB, TÜV Rheinland/GS, TÜV Rheinland/Ergonomics Approved, TCO'99, EPA Energy Star® Program

---

## F67/FX-D7

### Electrical Specifications

CRT	50 cm (19 inch) class, 90° deflection FS type CRT with Anti-Reflective SuperErgoCoat®
CRT Dot Pitch	0.26 mm
Scan Frequency	
Horizontal:	30 kHz-96 kHz (Automatic)
Vertical:	50 Hz-160 Hz (Automatic)
Max. Active Display Area	363 mm (H) × 272 mm (V) (14.2" (H) × 10.7" (V)) (Diagonal: 453 mm (17.8")) * Display size can be set by the user through microprocessor control panel. * The actual size displayed can be dependent on the graphics board or PC utilized.
Power Supply	100-120/220-240 VAC±10%, 50/60 Hz, 1.6/0.8 A
Power Consumption	
Normal/Max:	120 W/150 W (with EIZO optional speaker & USB attached)
PowerManager Mode 1:	Less than 10 W *
PowerManager Mode 2:	Less than 3 W * (* When the USB hub is not connected)
Input Connector	D-Sub mini 15-pin and BNC × 5 (switchable)
Recommended Resolution	1280 dots × 1024 lines
Input Signal	
Sync:	<ul style="list-style-type: none"><li>• H/V Separate, TTL, Positive/Negative</li><li>• H/V Composite, TTL, Positive/Negative</li><li>• Sync on Green 0.3 Vp-p, Negative</li><li>• Analog 0.7 Vp-p/75 Ω, Positive</li></ul>
Video:	

### Mechanical Specifications

Dimensions	452 mm (W) × 455 mm (H) × 478 mm (D) (17.8" (W) × 17.9" (H) × 18.8" (D))
Weight	24.0 kg (52.9 lbs.)

### USB Specifications

USB standard	Rev. 1.0 complied self-powered hub
Downstream power supply	500 mA for each (Max.)
Communication speed	12 Mbps (full), 1.5 Mbps (low)
USB ports	Upstream port x 1, Downstream ports x 4

### Environmental Specifications

Temperature	operating: 0°C to 40°C (32 °F to 104 °F) storage: -20°C to 60°C (-20 °F to 140 °F)
Humidity	30% to 80% R.H. Non-condensing

### Certifications and Standards

100-120 VAC range	UL/CSA, FCC-B, DHHS, TÜV Rheinland/Ergonomics Approved, TCO'99, EPA Energy Star® Program
220-240 VAC range	CE, CB, TÜV Rheinland/GS, TÜV Rheinland/Ergonomics Approved, TCO'99, EPA Energy Star® Program

**APPENDIX**  
**ANHANG**  
**ANNEXE**

# APPENDIX

## Pin Assignment Pin-Belegung Affectation des Broches

### D-Sub mini 15 pin connector

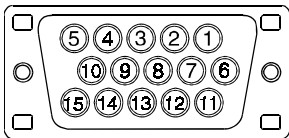

Pin No.	Signal	Pin No.	Signal
1	Red video	9	No pin
2	Green video	10	Ground (shorted)
3	Blue video	11	
4	Ground	12	Data
5	No pin	13	H. Sync
6	Red ground	14	V. Sync
7	Green ground	15	Clock
8	Blue ground		

### BNC connector

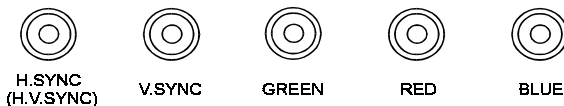

Connector Input signal	H.Sync	V. Sync	Green	Red	Blue
Sync on green	N/A	N/A	Green Composite sync	Red	Blue
Composite sync	TTL H/V composite sync	N/A	Green	Red	Blue
Separate sync	TTL H. Sync	TTL V. Sync	Green	Red	Blue

# Preset Timing

## Vordefinierte Timing-Werte

### Signaux prédéfinis

2 factory presets shown below have been registered in the monitor's microprocessor.

Der Monitor unterstützt 2 werkseitig vorgegebene Timing-Werte (siehe unten). Diese Werte sind im Mikroprozessor Ihres Monitors gespeichert.

Les deux signaux ci-dessous ont été enregistrés en usine dans le microprocesseur du moniteur.

	Resolution	Frequencies		Interlace	Sync Polarity	Video Signal Level
		fH (kHz)	fV (Hz)			
VGA (text)	720 x 400	31.47	70.09	Non	H/Negative V/Positive	0.7V(p-p)/75Ω
VESA	1280 x 1024	91.15	85.02	Non	H/Positive V/Positive	0.7V(p-p)/75Ω

**A**

## Dimensions

## Abmessungen

## Dimensions

mm  
(inches)

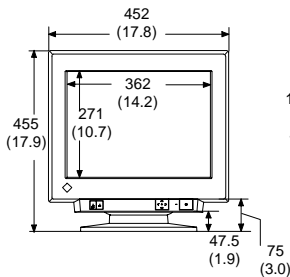

**FRONT VIEW**  
**VORDERANSICHT**  
**VUE DE FACE**

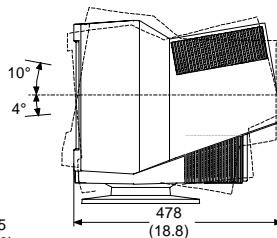

**SIDE VIEW**  
**SEITENANSICHT**  
**VUE DE CÔTÉ**

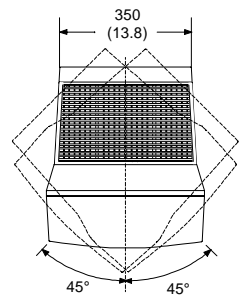

**TOP VIEW**  
**DRAUFSICHT**  
**VUE D'EN HAUT**



## **Congratulations!**

You have just purchased a TCO'99 approved and labelled product! Your choice has provided you with a product developed for professional use. Your purchase has also contributed to reducing the burden on the environment and also to the further development of environmentally adapted electronics products.

## **Why do we have environmentally labelled computers?**

In many countries, environmental labelling has become an established method for encouraging the adaptation of goods and services to the environment. The main problem, as far as computers and other electronics equipment are concerned, is that environmentally harmful substances are used both in the products and during their manufacture. Since it is not so far possible to satisfactorily recycle the majority of electronics equipment, most of these potentially damaging substances sooner or later enter nature.

There are also other characteristics of a computer, such as energy consumption levels, that are important from the viewpoints of both the work (internal) and natural (external) environments. Since all methods of electricity generation have a negative effect on the environment (e.g. acidic and climate-influencing emissions, radioactive waste), it is vital to save energy. Electronics equipment in offices is often left running continuously and thereby consumes a lot of energy.

## **What does labelling involve?**

This product meets the requirements for the TCO'99 scheme which provides for international and environmental labelling of personal computers. The labelling scheme was developed as a joint effort by the TCO (The Swedish Confederation of Professional Employees), Svenska Naturskyddsforeningen (The Swedish Society for Nature Conservation) and Statens Energimyndighet (The Swedish National Energy Administration).

Approval requirements cover a wide range of issues: environment, ergonomics, usability, emission of electric and magnetic fields, energy consumption and electrical and fire safety.

The environmental demands impose restrictions on the presence and use of heavy metals, brominated and chlorinated flame retardants, CFCs (freons) and chlorinated solvents, among other things. The product must be prepared for recycling and the manufacturer is obliged to have an environmental policy which must be adhered to in each country where the company implements its operational policy.

The energy requirements include a demand that the computer and/or display, after a certain period of inactivity, shall reduce its power consumption to a lower level in one or more stages. The length of time to reactivate the computer shall be reasonable for the user.

Labelled products must meet strict environmental demands, for example, in respect of the reduction of electric and magnetic fields, physical and visual ergonomics and good usability.

Below you will find a brief summary of the environmental requirements met by this product. The complete environmental criteria document may be ordered from:

TCO Development

SE-114 94 Stockholm, Sweden

Fax: +46 8 782 92 07

Email (Internet): [development@tco.se](mailto:development@tco.se)

Current information regarding TCO'99 approved and labelled products may also be obtained via the Internet, using the address: <http://www.tco-info.com/>

## **Environmental requirements**

### **Flame retardants**

Flame retardants are present in printed circuit boards, cables, wires, casings and housings. Their purpose is to prevent, or at least to delay the spread of fire. Up to 30% of the plastic in a computer casing can consist of flame retardant substances. Most flame retardants contain bromine or chloride, and those flame retardants are chemically related to another group of environmental toxins, PCBs. Both the flame retardants containing bromine or chloride and the PCBs are suspected of giving rise to severe health effects, including reproductive damage in fish-eating birds and mammals, due to the bio-accumulative\* processes. Flame retardants have been found in human blood and researchers fear that disturbances in foetus development may occur.

The relevant TCO'99 demand requires that plastic components weighing more than 25 grams must not contain flame retardants with organically bound bromine or chlorine. Flame retardants are allowed in the printed circuit boards since no substitutes are available.

### **Cadmium\*\***

Cadmium is present in rechargeable batteries and in the colour-generating layers of certain computer displays. Cadmium damages the nervous system and is toxic in high doses. The relevant TCO'99 requirement states that batteries, the colour-generating layers of display screens and the electrical or electronics components must not contain any cadmium.

### **Mercury\*\***

Mercury is sometimes found in batteries, relays and switches. It damages the nervous system and is toxic in high doses. The relevant TCO'99 requirement states that batteries may not contain any mercury. It also demands that mercury is not present in any of the electrical or electronics components associated with the labelled unit.

### **CFCs (freons)**

The relevant TCO'99 requirement states that neither CFCs nor HCFCs may be used during the manufacture and assembly of the product. CFCs (freons) are sometimes used for washing printed circuit boards. CFCs break down ozone and thereby damage the ozone layer in the stratosphere, causing increased reception on earth of ultraviolet light with e.g. increased risks of skin cancer (malignant melanoma) as a consequence.

### **Lead\*\***

Lead can be found in picture tubes, display screens, solders and capacitors. Lead damages the nervous system and in high doses, causes lead poisoning. The relevant TCO'99 requirement permits the inclusion of lead since no replacement has yet been developed.

## For Europe, etc. (220-240 Vac) Only

### CE Marking

#### Declaration of Conformity

Kind of equipment:	Monitor
Type-designation:	T68 (Model No. MA-1991), TX-D7 (Model No. MA-1991)

is in compliance with:

Council Directive 73/23/EEC	EN60950:1992+A1+A2+A3	
Council Directive 89/336/EEC	EN55022 (classB):1995	EN50082-1:1992
	EN61000-3-2:1995	EN61000-3-3:1995

#### Konformitätserklärung

Geräteart :	Monitor
Gerätetyp :	T68 (Modell-Nr. MA-1991), TX-D7 (Modell-Nr. MA-1991)

den folgenden Normen oder Vorschriften entspricht:

EU-Richtlinie 73/23/EEC	EN60950:1992+A1+A2+A3	
EU-Richtlinie 89/336/EEC	EN55022 (classB):1995	EN50082-1:1992
	EN61000-3-2:1995	EN61000-3-3:1995

#### Déclaration de conformité

Nature de l'équipement :	Moniteur
Type-désignation :	T68 (No. de modèle MA-1991), TX-D7 (Modell-Nr. MA-1991)

est en conformité avec :

Directive Européenne 73/23/EEC	EN60950:1992+A1+A2+A3	
Directive Européenne 89/336/EEC	EN55022 (classB):1995	EN50082-1:1992
	EN61000-3-2:1995	EN61000-3-3:1995

#### Hinweis zur Ergonomie :

Dieser Monitor erfüllt die Anforderungen an die Ergonomie nach ZH1/618/10.80 durch die Ansteuerung mit der VGA - Videokarte, 1280 Punkte x 1024Zeilen, RGB analog, 0,7 Vp-p und mindestens 85,0 Hz Bildwiederholfrequenz, non interlaced.

Weiterhin wird aus ergonomischen Gründen empfohlen, die Grundfarbe Blau nicht auf dunklem Untergrund zu verwenden (schlechte Erkennbarkeit, Augenbelastung bei zu geringem Zeichenkontrast.)

#### PTB Note

Eigensichere Kathodestranlröhre nach Anlage III Röntgenverordnung. Die in diesem Geraet entstehende Röntgenstrahlung ist durch die eigensichere Kathodenstrahlrohre ausreichend abgeschirmt.

#### Recycle Auskunft

Die Rücknahme dieses Produktes nach Nutzungsende übernimmt EIZO in Deutschland zusammen mit dem Partner von Roll MBB Recycling GmbH.  
Dort werden die Geräte in ihre Bestandteile zerlegt, die dann der Wiederverwertung zugeführt werden.  
Um einen Abholtermin zu vereinbaren und die aktuellen Kosten zu erfahren, benutzen Sie bitte folgende Rufnummer: 02153-73 35 00. Weitere Informationen finden Sie auch unter der Internet-Adresse: [www.eizo.de](http://www.eizo.de).

#### Hinweis

Die Bildrohre dieses Monitors is frei von Cadmium.



## For Europe, etc. (220-240 Vac) Only

### CE Marking

#### Declaration of Conformity

Kind of equipment:	Monitor
Type-designation:	F67 (Model No. MA-1990), FX-D7 (Model No. MA-1990)

is in compliance with:

Council Directive 73/23/EEC	EN60950:1992+A1+A2+A3	
Council Directive 89/336/EEC	EN55022 (classB):1995	EN50082-1:1992
	EN61000-3-2:1995	EN61000-3-3:1995

#### Konformitätserklärung

Geräteart :	Monitor
Gerätetyp :	F67 (Modell-Nr. MA-1990), FX-D7 (Modell-Nr. MA-1990)

den folgenden Normen oder Vorschriften entspricht:

EU-Richtlinie 73/23/EEC	EN60950:1992+A1+A2+A3	
EU-Richtlinie 89/336/EEC	EN55022 (classB):1995	EN50082-1:1992
	EN61000-3-2:1995	EN61000-3-3:1995

#### Déclaration de conformité

Nature de l'équipement :	Moniteur
Type-désignation :	F67 (No. de modèle MA-1990), FX-D7 (Modell-Nr. MA-1990)

est en conformité avec :

Directive Européenne 73/23/EEC	EN60950:1992+A1+A2+A3	
Directive Européenne 89/336/EEC	EN55022 (classB):1995	EN50082-1:1992
	EN61000-3-2:1995	EN61000-3-3:1995

#### Hinweis zur Ergonomie :

Dieser Monitor erfüllt die Anforderungen an die Ergonomie nach ZH1/618/10.80 durch die Ansteuerung mit der VGA - Videokarte, 1280 Punkte x 1024 Zeilen, RGB analog, 0,7 Vp-p und mindestens 85,0 Hz Bildwiederholfrequenz, non interlaced.

Weiterhin wird aus ergonomischen Gründen empfohlen, die Grundfarbe Blau nicht auf dunklem Untergrund zu verwenden (schlechte Erkennbarkeit, Augenbelastung bei zu geringem Zeichenkontrast.)

#### PTB Note

Eigensichere Kathodestranlröhre nach Anlage III Röntgenverordnung. Die in diesem Geräet entstehende Röntgenstrahlung ist durch die eigensichere Kathodenstrahlrohre ausreichend abgeschirmt.

#### Recycle Auskunft

Die Rücknahme dieses Produktes nach Nutzungsende übernimmt EIZO in Deutschland zusammen mit dem Partner von Roll MBB Recycling GmbH.

Dort werden die Geräte in ihre Bestandteile zerlegt, die dann der Wiederverwertung zugeführt werden. Um einen Abholtermin zu vereinbaren und die aktuellen Kosten zu erfahren, benutzen Sie bitte folgende Rufnummer: 02153-73 35 00. Weitere Informationen finden Sie auch unter der Internet-Adresse: [www.eizo.de](http://www.eizo.de).

#### Hinweis

Die Bildrohre dieses Monitors is frei von Cadmium.

For U.S.A, Canada, etc. (rated 100-120 Vac) Only

## FCC Declaration of conformity

**We, the Responsible Party**

**EIZO Nanao Technologies Inc.**  
**5710 Warland Drive, Cypress, CA 90630**  
**Phone: (562) 431-5011**

**declare that the product**

**Trade name: EIZO**  
**Model: FlexScan FX-D7/Model No: MA-1990**  
**Model: FlexScan TX-D7/Model No: MA-1991**

**is in conformity with Part 15 of the FCC Rules. Operation of this product is subject to the following two conditions: (1) this device may not cause harmful interference, and (2) this device must accept any interference received, including interference that may cause undesired operation.**

This equipment has been tested and found to comply with the limits for a Class B digital device, pursuant to Part 15 of the FCC Rules. These limits are designed to provide reasonable protection against harmful interference in a residential installation. This equipment generates, uses, and can radiate radio frequency energy and, if not installed and used in accordance with the instructions, may cause harmful interference to radio communications. However, there is no guarantee that interference will not occur in a particular installation. If this equipment does cause harmful interference to radio or television reception, which can be determined by turning the equipment off and on, the user is encouraged to try to correct the interference by one or more of the following measures.

- \*Reorient or relocate the receiving antenna.
- \*Increase the separation between the equipment and receiver.
- \*Connect the equipment into an outlet on a circuit different from that to which the receiver is connected.
- \*Consult the dealer or an experienced radio/TV technician for help.

Changes or modifications not expressly approved by the party responsible for compliance could void the user's authority to operate the equipment.

### **Note**

Use the attached specified shielded cable below or EIZO signal cable with this monitor so as to keep interference within the limits of a Class B digital device.

- AC Cord
- Signal Cable (D-SUB mini 15 pin - D-SUB mini 15 pin, MD-C87)

## Canadian Notice

This Class B digital apparatus complies with Canadian ICES-003.

Cet appareil numérique de la classe B est conforme à la norme NMB-003 du Canada.