

# User's Manual

# FlexScan® T1501 T1502

## Touch Panel Color LCD Monitor

### Important

Please read this User's Manual and Setup Manual (separate volume) carefully to familiarize yourself with safe and effective usage.

### PRECAUTIONS

### CONTENTS

#### Chapter 1 Features and Overview

- 1-1 Features
- 1-2 Buttons and Indicators
- 1-3 Functions and Basic Operation

#### Chapter 2 Settings and Adjustments

- 2-1 Utility Disk
- 2-2 Screen Adjustment
- 2-3 Color Adjustment
- 2-4 Off Timer Settings
- 2-5 Power Indicator/EIZO Logo Display Settings
- 2-6 Locking Buttons
- 2-7 Setting Adjustment Menu Position
- 2-8 Viewing Information/Setting Language
- 2-9 Setting BrightRegulator
- 2-10 Resumption of Default Setting

#### Chapter 3 Connecting Cables

- 3-1 Connecting Two PCs to the Monitor

#### Chapter 4 Troubleshooting

#### Chapter 5 Reference

- 5-1 Attaching an Arm
- 5-2 Power Saving Mode
- 5-3 Cleaning
- 5-4 Specifications
- 5-5 Glossary
- 5-6 Preset Timing





### How to Setup

Please read the Setup Manual (separate volume)



# SAFETY SYMBOLS

This manual uses the safety symbols below. They denote critical information. Please read them carefully.

	<b>WARNING</b> Failure to abide by the information in a WARNING may result in serious injury and can be life threatening.		<b>CAUTION</b> Failure to abide by the information in a CAUTION may result in moderate injury and/or property or product damage.
	Indicates a prohibited action.		
	Indicates a mandatory action that must be followed.		

---

Copyright© 2007 EIZO NANA O CORPORATION All rights reserved.

No part of this manual may be reproduced, stored in a retrieval system, or transmitted, in any form or by any means, electronic, mechanical, or otherwise, without the prior written permission of EIZO NANA O CORPORATION. EIZO NANA O CORPORATION is under no obligation to hold any submitted material or information confidential unless prior arrangements are made pursuant to EIZO NANA O CORPORATION's receipt of said information. Although every effort has been made to ensure that this manual provides up-to-date information, please note that EIZO monitor specifications are subject to change without notice.

---

Apple and Macintosh are registered trademarks of Apple Inc.  
VGA is a registered trademark of International Business Machines Corporation.  
DPMS is a trademark and VESA is a registered trademark of Video Electronics Standards Association.  
Windows is a registered trademark of Microsoft Corporation.  
PowerManager is a trademark of EIZO NANA O CORPORATION.  
FlexScan, ScreenManager and EIZO are registered trademarks of EIZO NANA O CORPORATION in Japan and other countries.

<p>Product specification may vary with sales areas. Confirm the specification in the manual written in language of the region of purchase.</p>
--

# ⚠ PRECAUTIONS

## IMPORTANT

- This product has been adjusted specifically for use in the region to which it was originally shipped. If the product is used outside the region, it may not operate as specified in the specifications.
- To ensure personal safety and proper maintenance, please read carefully this section and the caution statements on the monitor.

## [Location of Caution Statement]

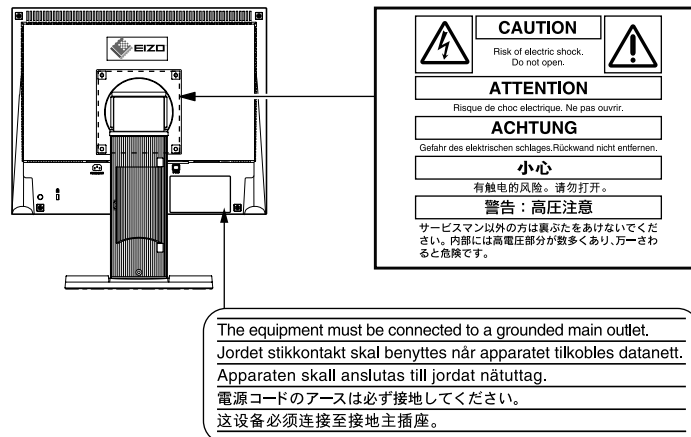

## ⚠ WARNING

**If the unit begins to emit smoke, smells like something is burning, or makes strange noises, disconnect all power connections immediately and contact your dealer for advice.**

Attempting to use a malfunctioning unit may result in fire, electric shock, or equipment damage.

**Do not open the cabinet or modify the unit.**

Opening the cabinet or modifying the unit may result in fire, electric shock, or burn.



**Refer all servicing to qualified service personnel.**

Do not attempt to service this product yourself as opening or removing covers may result in fire, electric shock, or equipment damage.

**Keep small objects or liquids away from the unit.**

Small objects accidentally falling through the ventilation slots into the cabinet or spillage into the cabinet may result in fire, electric shock, or equipment damage.

If an object or liquid falls/spills into the cabinet, unplug the unit immediately. Have the unit checked by a qualified service engineer before using it again.

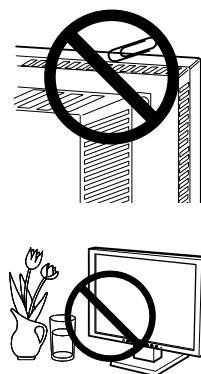

## WARNING

---

### **Place the unit at the strong and stable place.**

A unit placed on an inadequate surface may fall and result in injury or equipment damage. If the unit falls, disconnect the power immediately and ask your dealer for advice. Do not continue using a damaged unit. Using a damaged unit may result in fire or electric shock.

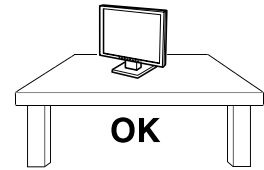

### **Set the unit in an appropriate location.**

Not doing so may result in fire, electric shock, or equipment damage.

- Do not place outdoors.
- Do not place in the transportation system (ship, aircraft, trains, automobiles, etc.)
- Do not place in a dusty or humid environment.
- Do not place in a location where the steam comes directly on the screen.
- Do not place near heat generating devices or a humidifier.

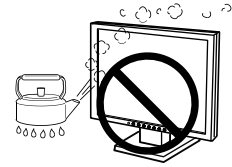

### **To avoid danger of suffocation, keep the plastic packing bags away from babies and children.**

### **Use the enclosed power cord and connect to the standard power outlet of your country.**

Be sure to remain within the rated voltage of the power cord.

Not doing so may result in fire or electric shock.

### **To disconnect the power cord, grasp the plug firmly and pull.**

Tugging on the cord may damage and result in fire or electric shock.



### **The equipment must be connected to a grounded main outlet.**

Failure to do so may result in fire or electric shock.



### **Use the correct voltage.**

- The unit is designed for use with a specific voltage only. Connection to another voltage than specified in this User's Manual may cause fire, electric shock, or equipment damage.
- Do not overload your power circuit, as this may result in fire or electric shock.

### **Handle the power cord with care.**

- Do not place the cord underneath the unit or other heavy objects.
- Do not pull on or tie the cord.

If the power cord becomes damaged, stop using it. Use of a damaged cord may result in fire or electric shock.

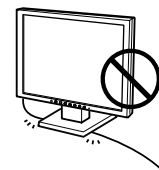

### **Never touch the plug and power cord if it begins to thunder.**

Touching them may result in electric shock.

---

 **WARNING**

---

**When attaching an arm stand, please refer to the user's manual of the arm stand and install the unit securely.**

Not doing so may cause the unit to become unattached, which may result in injury or equipment damage. When the unit is dropped, please ask your dealer for advice. Do not continue using a damaged unit. Using a damaged unit may result in fire or electric shock. When reattaching the tilt stand, please use the same screws and tighten them securely.

---

**Do not touch a damaged LCD panel directly with bare hands.**

The liquid crystal that may leak from the panel is poisonous if it enters the eyes or mouth. If any part of the skin or body comes in direct contact with the panel, please wash thoroughly. If some physical symptoms result, please consult your doctor.



**Lamps contain mercury, dispose according to local, state or federal laws.**

---

## CAUTION

---

### **Handle with care when carrying the unit.**

Disconnect the power cord and cables when moving the unit. Moving the unit with the cord attached is dangerous. It may result in injury.

---

### **When handling the unit, grip the bottom of the unit firmly with both hands ensuring the panel faces outward before lifting.**

Dropping the unit may result in injury or equipment damage.

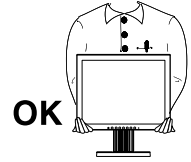

### **Do not block the ventilation slots on the cabinet.**

- Do not place any objects on the ventilation slots.
- Do not install the unit in a closed space.
- Do not use the unit laid down or upside down.

Blocking the ventilation slots prevents proper airflow and may result in fire, electric shock, or equipment damage.



### **Do not touch the plug with wet hands.**

Doing so may result in electrical shock.



### **Use an easily accessible power outlet.**

This will ensure that you can disconnect the power quickly in case of a problem.

---

### **Periodically clean the area around the plug.**

Dust, water, or oil on the plug may result in fire.

---

### **Unplug the unit before cleaning it.**

Cleaning the unit while it is plugged into a power outlet may result in electric shock.

---

**If you plan to leave the unit unused for an extended period, disconnect the power cord from the wall socket after turning off the power switch for the safety and the power conservation.**

---

## LCD Panel

---

In order to suppress the luminosity change by long-term use and to maintain the stable luminosity, use of a monitor in lower brightness is recommended.

---

The LCD panel is manufactured using high-precision technology. However, note that the appearance of any missing pixels or lit pixels does not indicate damage to the LCD monitor.

Percentage of effective pixels: 99.9994% or higher.

---

The backlight of the LCD panel has a fixed life span. When the screen becomes dark or begins to flicker, please contact your dealer.

---

Do not scratch or press on the panel with any sharp objects, such as a pencil or pen as this may result in damage to the panel. Do not attempt to brush with tissues as this may scratch the panel.

---

When the monitor is cold and brought into a room or the room temperature goes up quickly, dew condensation may occur inside and outside the monitor. In that case, do not turn the monitor on and wait until dew condensation disappears, otherwise it may cause damage to the monitor.

---

When the screen image is changed after displaying the same image for extended periods of time, an afterimage may appear. Use the screen saver or timer to avoid displaying the same image for extended periods of time.

---

---

## To use the monitor comfortably

---

An excessively dark or bright screen may affect your eyes. Adjust the brightness of the monitor according to the environmental conditions.

---

Staring at the monitor for a long time tires your eyes. Take a 10-minute rest every hour.

---

---

# CONTENTS

<b>PRECAUTIONS</b> .....	<b>1</b>	<b>2-8 Viewing Information/Setting Language</b> .....	<b>18</b>
LCD Panel.....	5	• To check settings, usage time, etc. [Information] .....	18
To use the monitor comfortably .....	5	• To set a language to be displayed [Language] .....	18
<b>Chapter 1 Features and Overview</b> .....	<b>7</b>	<b>2-9 Setting BrightRegulator</b> .....	<b>18</b>
<b>1-1 Features</b> .....	<b>7</b>	• To set automatic brightness adjustment [BrightRegulator] .....	18
<b>1-2 Buttons and Indicators</b> .....	<b>7</b>	<b>2-10 Resumption of Default Setting</b> .....	<b>19</b>
<b>1-3 Functions and Basic Operation</b> .....	<b>8</b>	• To reset color adjustment [Reset].....	19
<b>Chapter 2 Settings and Adjustments</b> .....	<b>10</b>	• To reset all settings [Reset].....	19
<b>2-1 Utility Disk</b> .....	<b>10</b>	<b>Chapter 3 Connecting Cables</b> .....	<b>20</b>
• Disk contents and software overview .....	10	<b>3-1 Connecting Two PCs to the Monitor</b> .....	<b>20</b>
<b>2-2 Screen Adjustment</b> .....	<b>11</b>	• To set input signal selection [Input Signal] .....	20
Digital Input.....	11	<b>Chapter 4 Troubleshooting</b> .....	<b>21</b>
Analog Input .....	11	<b>Chapter 5 Reference</b> .....	<b>23</b>
<b>2-3 Color Adjustment</b> .....	<b>14</b>	<b>5-1 Attaching an Arm</b> .....	<b>23</b>
Simple Adjustment [FineContrast Mode].....	14	<b>5-2 Power Saving Mode</b> .....	<b>24</b>
• FineContrast mode.....	14	<b>5-3 Cleaning</b> .....	<b>24</b>
• To select FineContrast mode.....	14	<b>5-4 Specifications</b> .....	<b>25</b>
Advanced Adjustments [Adjustment Menu] .....	15	<b>5-5 Glossary</b> .....	<b>28</b>
• To select an appropriate mode for images .....	15	<b>5-6 Preset Timing</b> .....	<b>29</b>
• To set/adjust color .....	15		
<b>2-4 Off Timer Settings</b> .....	<b>16</b>		
• To set monitor power-off time [Off Timer] .....	16		
<b>2-5 Power Indicator/EIZO Logo Display Settings</b> .....	<b>17</b>		
• To turn off the Power indicator while a screen is displayed [Power Indicator].....	17		
• To display EIZO logo [EIZO Logo Appearing Function].....	17		
<b>2-6 Locking Buttons</b> .....	<b>17</b>		
• To lock operation [Adjustment Lock].....	17		
<b>2-7 Setting Adjustment Menu Position</b> .....	<b>18</b>		
• To adjust the menu position [Menu Position]....	18		



# Chapter 1 Features and Overview

Thank you very much for choosing an EIZO color LCD monitor.

## 1-1 Features

- Dual-input compliant (DVI-D and D-sub mini 15-pin connectors)
- DVI digital input (TMDS) compliant
- Horizontal scan frequency: Analog: 24.8 - 60 kHz  
Digital: 31 - 49 kHz
- Vertical scan frequency: Analog: 55 - 75 Hz  
Digital: 59 - 61 Hz (VGA text: 69 - 71 Hz)
- Resolution: 1024 dots × 768 lines
- Stereo speakers
- Smoothing (soft - sharp) function
- BrightRegulator function incorporated
- FineContrast mode to allow the best mode for screen display
- Touch Panel provided
- Touch Panel Pointer “TP1” is available (optional)

## 1-2 Buttons and Indicators

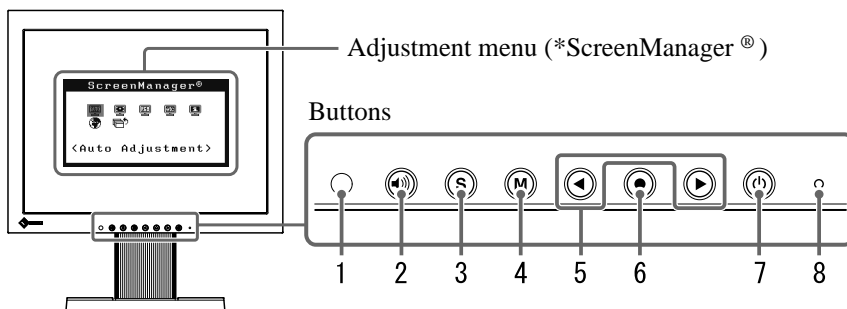

1. Sensor (BrightRegulator)
2. Volume control button
3. Input signal selection button
4. Mode button
5. Control buttons (Left, Right)
6. Enter button
7. Power button
8. Power indicator

Indicator status	Operation status
Blue	The screen is displayed
Orange	Power saving
Off	Power off

\* ScreenManager® is an EIZO's nickname of the Adjustment menu.

### NOTE

- The stand of the unit can be replaced with an arm or another stand. (Refer to “5-1 Attaching an Arm” on page 23.)

### NOTE

- While the screen is displayed, the blue power indicator that is lighting blue can be turned off (see “To turn off the Power indicator while a screen is displayed [Power Indicator]” on page 17).
- For the power indicator status with “Off Timer” set, refer to “To set monitor power-off time [Off Timer]” on page 16.

# 1-3 Functions and Basic Operation

## To adjust the screen and color

● Main menu (Refer to page 9 for operation)

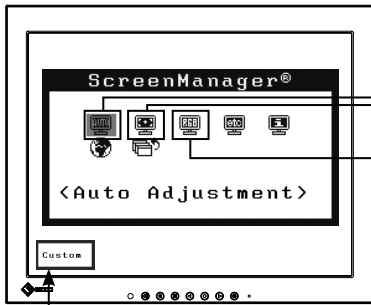

- The Adjustment menu and the FineContrast mode cannot be displayed at the same time.

Ⓜ FineContrast mode

**Color Adjustment (Simple adjustment) [FineContrast mode]** Page 14

This function allows easy selection of a desired mode from three modes according to monitor application.

```

    graph TD
      Custom[Custom] --> sRGB[sRGB]
      sRGB --> Text[Text]
      Text --> Custom
    
```

**Brightness Adjustment**

Press ◀ or ▶ to adjust brightness.

**Volume Adjustment**

**1** Press 🔊.

**2** Press ◀ or ▶ to adjust volume.

(for analog signal input only)

**1 Screen Adjustment (Automatic Adjustment)** Page 11

- To adjust flickering and position [Screen] ..... see page 11
- To adjust color gradation automatically [Range] ..... see page 13

**2 Screen Adjustment (Advanced Adjustment)** Page 11

**[Adjustment menu]**

<p>[At analog signal input]</p> <p>&lt;Clock&gt;</p>	<p>[At digital signal input]</p> <p>&lt;Smoothing&gt;</p>
--	---

- To eliminate vertical bars [Clock\*] ... see page 12
- To remove flickering or blurring [Phase\*] ..... see page 12
- To correct screen position [Hor. Position\*] ..... see page 12
- [Ver. Position\*] ..... see page 12
- To modify blurred characters/lines [Smoothing] ..... see page 13

\* Items marked with \* can be adjusted with analog input.

**Color Adjustment (Advanced Adjustment)** Page 15

- “Brightness,” “Contrast,” “Temperature,” “Gamma,” and “Gain” can be set for each mode (Custom/sRGB/Text).  
Settable functions vary with the display mode.

**Resumption of Default Setting**

- To reset color adjustment [Reset] ... see page 19

## To make useful settings/adjustments

### ● Adjustment menu (Refer to below for operation)

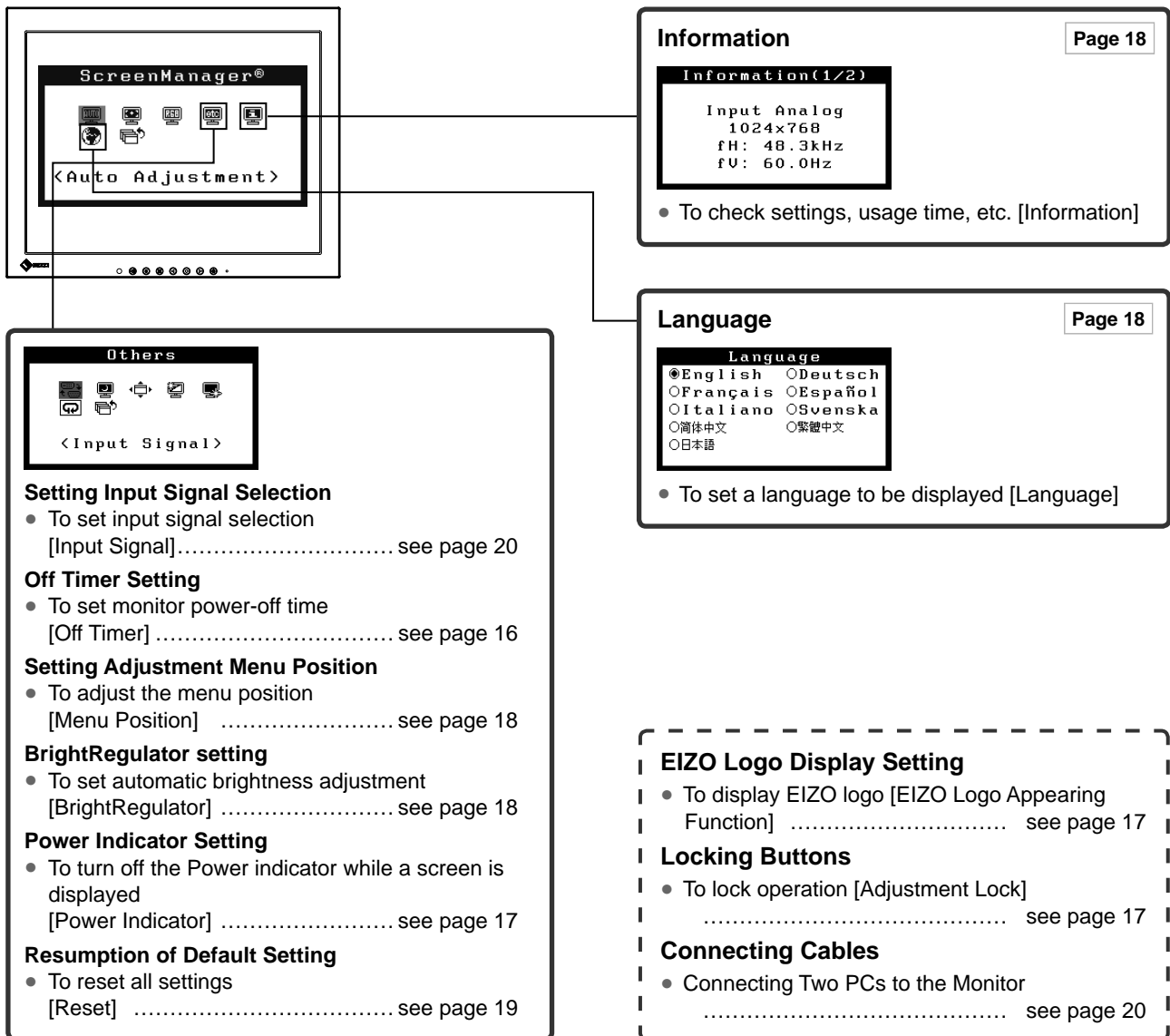

## Basic operation of Adjustment menu

### [Displaying Adjustment menu and selecting function]

- Press ●. The main menu appears.
- Select a function with ◀ or ▶, and press ●. The sub menu appears.
- Select a function with ◀ or ▶, and press ●. The adjustment/setting menu appears.
- Adjust the selected item with ◀ or ▶, and press ●. The setting is saved.

### [Exiting Adjustment menu]

- Choose <Return> from the sub menu and press ●.
- Choose <Exit> from the main menu and press ●.

#### NOTE

- The Adjustment menu can also be exited by pressing ● twice quickly.

# Chapter 2 Settings and Adjustments

---

## 2-1 Utility Disk

An “EIZO LCD Utility Disk” (CD-ROM) is supplied with the monitor. The following table shows the disk contents and the overview of the application software programs.

- **Disk contents and software overview**

The disk includes color profiles, application software programs for adjustment, and User's Manual. Refer to “Readme.txt” on the disk for software startup procedures or file access procedures.

Item	Overview	For Windows	For Macintosh
A “Readme.txt” file		✓	—
Color Profiles (ICC Profiles)	A specific file including the color characteristic information for the monitor.	✓	—
Screen Adjustment Program	Available for easy adjustments of the monitor screen following adjustment patterns and procedures on the screen.	✓	—
Touch Panel Driver	Driver for touch panel	✓	—
User's Manual of this monitor (PDF file)			
User's Manual for Touch Panel Driver (PDF file)			

## 2-2 Screen Adjustment

### Digital Input

When digital signals are input, images are displayed correctly based on the preset data of the monitor.

### Analog Input

The monitor screen adjustment is used to suppress flickering of the screen or adjust screen position and screen size correctly according to the PC to be used. To use the monitor comfortably, adjust the screen when the monitor is set up for the first time or when the settings of the PC in use are updated.





**The auto-adjustment function works in the following cases:**

- When a signal is input into the monitor for the first time
- When a signal is input into the monitor for the first time after the resolution or refresh rate of input signals is changed

#### [Adjustment Procedure]

##### ■ Automatic Adjustment

### 1 To adjust screen automatically [Screen]

- (1) Choose <Screen> from the <Auto Adjustment> menu, and press .
- (2) Select "Execute" with  or , and press .
- (3) Flickering, screen position, and screen size are corrected by the auto-adjustment function.

**If satisfactory adjustment cannot be obtained with the auto-adjustment function, perform the adjustment following the procedure below. When the screen is displayed correctly, go to step 4 "Range Adjustment".**

##### ■ Advanced Adjustment

### 2 Run the Screen Adjustment Program.

Load the EIZO LCD Utility Disk on the PC, and start the Screen Adjustment Program compatible with the PC in use.

After the program starts up, perform the adjustment in step 3 following the instructions of the program.

#### Attention

- Wait 30 minutes or more from monitor power on before starting adjustments.

#### NOTE

- Use "Screen Adjustment Program" on the supplied EIZO LCD Utility Disk.

#### Attention

- This function works correctly when an image is fully displayed over the display area. It does not work properly when an image is displayed only on a part of the screen (DOS prompt window, for example) or when a black background (wallpaper, etc.) is in use.
- This function does not work correctly with some graphics boards.
- "Auto in Progress" appears on the screen during auto adjustment.



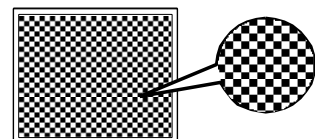

#### NOTE

- For how to start the Screen Adjustment Program, refer to "Readme.txt" file. You can run the program directly from the start menu of the disk.
- If no adjustment program is available for your PC, display a checkerboard pattern on the screen (see below) and go to the following steps.





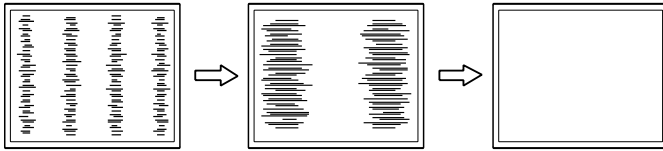

### 3 Perform advanced adjustments for the following using the <Screen> menu of the Adjustment menu.

- **To eliminate vertical bars [Clock]**

- (1) Choose <Clock> from the <Screen> menu, and press .  
The <Clock> menu appears.
- (2) Adjust the clock with  or , and press .  
The adjustment is completed.



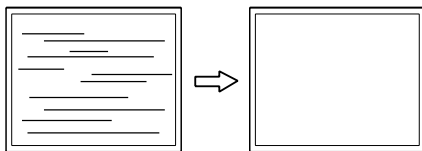

- **To remove flickering or blurring [Phase]**

- (1) Choose <Phase> from the <Screen> menu, and press .  
The <Phase> menu appears.
- (2) Adjust the phase with  or , and press .  
The adjustment is completed.



- **To correct screen position [Hor. Position], [Ver. Position]**

Since the number of pixels and the pixel positions are fixed on the LCD monitor, only one position is provided to display images correctly. The position adjustment is made to shift an image to the correct position.

- (1) Choose <Hor. Position> and or <Ver. Position> from the <Screen> menu, and press .  
The <Hor. Position> or <Ver. Position> menu appears.
- (2) Adjust the position with  or  to display the image properly in the display area of the monitor.

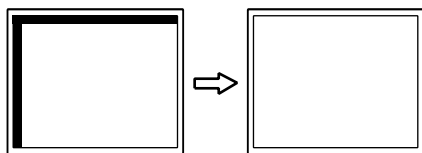

#### NOTE

- Press the control button slowly so as not to miss the adjustment point.
- When blurring, flickering or bars appear on the screen after adjustment, proceed to [Phase] to remove flickering or blurring.

#### Attention

- Flickering or blurring may not be eliminated depending on your PC or graphics board.





#### NOTE

- When vertical bars appear on the screen after adjustment, go back to “To eliminate vertical bars [Clock].” (Clock → Phase → Position)

## 4 Adjust the signal output range.

- **To adjust color gradation automatically [Range]**

Every color gradation (0 to 255) can be displayed by adjusting the signal output level.





- (1) Choose <Range> from the <Auto Adjustment> menu, and press .
- (2) Select “Execute” with  or , and press .
- (3) Color gradation is adjusted correctly by the auto-adjustment function.  
The output range is adjusted automatically.

When using the “Screen Adjustment Program”, the program is finished.

## 5 Change the smoothing setting.

- **To modify blurred characters/lines [Smoothing]**

When a low-resolution image is displayed, the characters or lines of the displayed image may be blurred.

- (1) Choose <Smoothing> from the <Screen> menu, and press .  
The <Smoothing> menu appears.
- (2) Select a suitable level from 1 to 5 (where 1 = soft and 5 = sharp) with  or , and press .  
The smoothing adjustment is completed.

## 2-3 Color Adjustment

### Simple Adjustment [FineContrast Mode]

This function allows you to select the best display mode for monitor brightness, etc.

- **FineContrast mode**

An appropriate display mode is selectable out of three modes.

Mode	Purpose
Custom	Available for making desired setting.
sRGB	Suitable for color matching with sRGB compatible peripherals.
Text	Suitable for displaying texts for word processing or spreadsheets.

FineContrast mode name  
Example) Custom



- **To select FineContrast mode**

(1) Press **(M)**.

The FineContrast mode changes at every time pressing **(M)**.

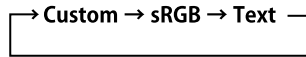

(2) Choose desired mode and press **(●)**.

The setting completes.

**NOTE**

- The Adjustment menu and the FineContrast mode cannot be displayed at the same time.



## Advanced Adjustments [Adjustment Menu]

Independent setting and saving of color adjustment are available for each FineContrast mode.

### • To select an appropriate mode for images

✓: Adjustment available    -: Invalid for adjustment

Icon	Function	FineContrast mode		
		Custom	sRGB	Text
	Brightness	✓	✓	✓
	Contrast	✓	-	✓
	Temperature	✓	-	✓
	Gamma	✓	-	✓
	Gain	✓	-	-
	Reset	✓	✓	✓

Menu	Description	Adjustment range
Brightness 	To adjust the full screen brightness as desired <b>NOTE</b> • You can also adjust the brightness by pressing ◀ or ▶ button while the adjustment menu is not displayed. • Press ● after adjustment.	0 to 100%
Contrast 	To adjust the contrast of the image	0 to 100%
Temperature 	To select a color temperature <b>NOTE</b> • Setting the value to “Off” presents the natural color of the panel. • The values shown in the Kelvin (K) are available only as reference.	4000K to 10000K in units of 500K (including 9300K).
Gamma 	To set a gamma value	1.8, 2.0, 2.2
Gain 	To adjust red, green, and blue to a desired color tone respectively <b>NOTE</b> • Values shown in percentage are available only as reference. • When using the <Gain> setting, the <Temperature> setting is set to “Off”.	0 to 100% Adjust the respective brightness of red/green/blue to make a desired color tone. Display an image with white or gray background for adjustment.
Reset 	To reset the color settings of the selected FineContrast mode to the default settings	

### • To set/adjust color

- Choose <Color> from the Adjustment menu, and press ●.
- Select a desired function from the <Color> menu, and press ●.  
The selected function menu appears.
- Adjust the selected item with ◀ or ▶, and press ●.  
The adjustment is completed.

### Attention

- Perform [Range Adjustment] before starting color adjustment for analog input signals.  
Refer to “To adjust color gradation automatically” on page 13.
- Wait 30 minutes or more from monitor power on before starting the color adjustment.
- Choose “Reset” in the <Color> menu to revert to the default settings (factory settings) of hue of the color mode selected.
- The same image may be seen in different colors on multiple monitors due to their monitor-specific characteristics. Make fine color adjustment visually when matching colors on multiple monitors.

### NOTE

- The Adjustment menu and the FineContrast mode cannot be displayed at the same time.
- Adjustable functions vary depending on the type of FineContrast mode.

## 2-4 Off Timer Settings

### • To set monitor power-off time [Off Timer]









This function allows the monitor to automatically turn off after a specified time has passed. This function serves to reduce afterimages caused when the monitor screen is left on for a long time period without use. Use this function when an image is displayed throughout the day.

#### [Off Timer System]

Timer	Monitor	Power Indicator
ON time (1H - 23H)	Operating	Blue
Last 15 min. in "ON time"	Advance Notice*	Flashing blue
"ON time" expired	Power Off	Off

\* When  is pressed during the advance notice period, the monitor continues to operate for additional 90 minutes. Extension of operation time can be set without limitation.

#### [Procedure]

- (1) Choose <Others> from the Adjustment menu, and press .
- (2) Choose <Off Timer> from the <Others> menu, and press .  
The <Off Timer> menu appears.
- (3) Select "Enable" with  or , and press .
- (4) Set a monitor ON time (1 to 23 hours) with  or , and press .  
The Off Timer setting is completed.

#### [Resumption Procedure]

- Press .





#### Attention

- The Off Timer functions even in the power saving mode, but the advance notice is disabled. The monitor power is turned off without advance notice.

## 2-5 Power Indicator/EIZO Logo Display Settings

### • To turn off the Power indicator while a screen is displayed [Power Indicator]



This function enables to turn off the Power indicator (blue) while a screen is displayed.

- (1) Choose <Others> from the Adjustment menu, and press .
- (2) Choose <Power Indicator> from the <Others> menu, and press .  
The <Power Indicator> menu appears.
- (3) Select "Disable" with  or , and press .  
The Power Indicator setting is completed.



### • To display EIZO logo [EIZO Logo Appearing Function]

When this unit is turned on, the EIZO logo appears at the center of the screen. Selection to display or not to display the logo is available with this function.

#### [Procedure]

- (1) Press  to power off the unit.
- (2) Press  again while pressing .  
The EIZO logo does not appear on the screen.







#### [Resetting]



- (1) Press  to power off the unit.
- (2) Press  again while pressing .  
The logo appears again.

## 2-6 Locking Buttons



### • To lock operation [Adjustment Lock]

This function locks the buttons to retain the status adjusted or set once.

Buttons that can be locked	<ul style="list-style-type: none"> <li>•  (Enter button) Adjustments/settings using Adjustment menu</li> </ul>
Buttons that cannot be locked	<ul style="list-style-type: none"> <li>•  /  (Control buttons)</li> <li>•  (Volume control button)</li> <li>•  (Input Signal Selection button)</li> <li>•  (Mode button)</li> <li>•  (Power button)</li> </ul>

- (1) Press  to turn off the unit.
- (2) Press  again while pressing .  
The screen is displayed with the adjustment lock.

#### [Unlocking]

- (1) Press  to turn off the unit.
- (2) Press  again while pressing .  
The screen is displayed with the adjustment lock released.

#### NOTE

- The Power indicator lights up at power on with the default setting.





#### NOTE

- The logo appears with the default setting.

## 2-7 Setting Adjustment Menu Position

### • To adjust the menu position [Menu Position]



Adjust the menu position using the following procedure.

- (1) Choose <Others> from the Adjustment menu, and press .
- (2) Choose <Menu Position> from the <Others> menu, and press .  
The <Menu Position> menu appears.
- (3) Select a menu position with  or , and press .  
The menu position setting is completed.

## 2-8 Viewing Information/Setting Language

### • To check settings, usage time, etc. [Information]

This function allows you to check settings, model name, serial number, and usage time of the monitor.





- (1) Choose <Information> from the Adjustment menu, and press .  
The <Information> menu appears.
- (2) Then, press  to check settings, etc.

### • To set a language to be displayed [Language]

Select the Adjustment menu language.

#### Selectable languages





English/German/French/Spanish/Italian/Swedish/Simplified Chinese/  
Traditional Chinese/Japanese

- (1) Choose <Language> menu from the Adjustment menu, and press .  
The <Language> menu appears.
- (2) Choose a language with  or , and press .  
The language setting is completed.

## 2-9 Setting BrightRegulator

### • To set automatic brightness adjustment [BrightRegulator]

The sensor on the front side of the monitor detects the environmental brightness to adjust the screen brightness automatically and comfortably.

- (1) Choose <Others> from the Adjustment menu, and press .
- (2) Choose < BrightRegulator> from the <Others> menu, and press .  
The BrightRegulator setting window appears.
- (3) Select “Enable” or “Disable” with  or , and press .  
The BrightRegulator setting is completed.

#### NOTE

- Five positions (center/ upper right/ lower right/ upper left/ lower left) can be selected.





#### NOTE

- The usage time is not always “0” when you purchase the monitor due to factory inspection.

## 2-10 Resumption of Default Setting





### • To reset color adjustment [Reset]

The hue in the color mode currently set will revert to the default settings (factory settings).

- (1) Choose <Color> from the Adjustment menu, and press .
- (2) Choose <Reset> from the <Color> menu and press .  
The <Reset> menu appears.
- (3) Select <Reset> with  or , and press .  
The reset operation is completed.

### • To reset all settings [Reset]

Reset all adjustments/settings to the factory default settings.

- (1) Choose <Others> from the Adjustment menu, and press .
- (2) Choose <Reset> from the <Others> menu, and press .  
The <Reset> menu appears.
- (3) Select <Reset> with  or , and press .  
The reset operation is completed.

#### NOTE

- For default settings, refer to “Main default settings (factory settings)” on page 26.

# Chapter 3 Connecting Cables

## 3-1 Connecting Two PCs to the Monitor

Two PCs can be connected to the monitor through the DVI-D and the D-Sub mini 15 pin connector on the back of the monitor.

### Connection examples

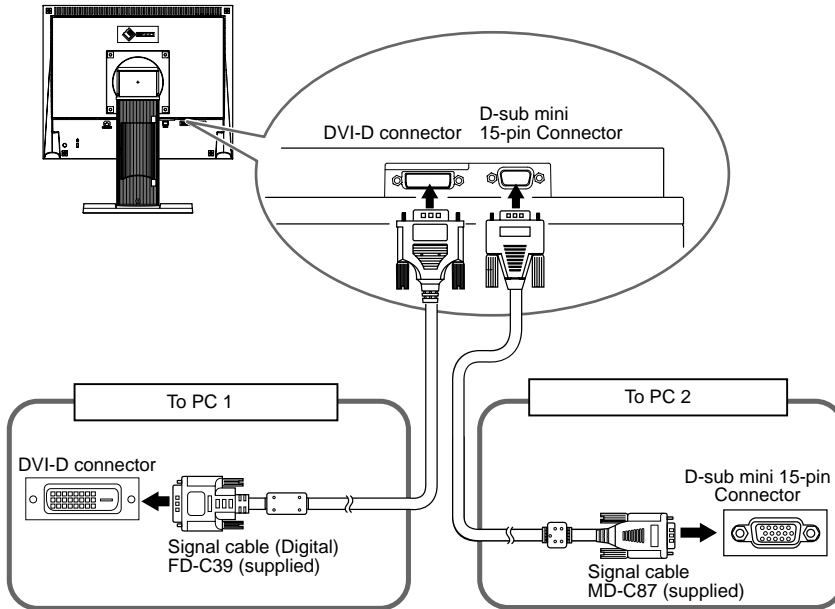

### Attention

- The touch panel monitor is designed to use connecting to one PC. If connecting two PCs, connect the touch panel monitor to one PC only (touch operation side) with a USB cable (MD-C93) or RC-232C cable (FD-C38-K).

### Selecting input signal

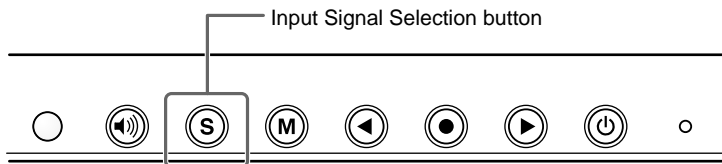

Switch the input signal with **(S)**. Input signal switches each time **(S)** is pressed. When the signal is switched, the active signal type (Analog or Digital) appears at the top right corner of the screen for three seconds.

### • To set input signal selection [Input Signal]

Setting	Function
Auto	When PC displayed on the monitor is turned off or enters the power-saving mode, the monitor automatically displays signals of another PC.
Manual	The monitor does not detect the PC's signals automatically. Select an input signal with <b>(S)</b> .







### [Procedure]

- Choose <Others> from the Adjustment menu, and press **(●)**.
- Choose <Input Signal> from the <Others> menu, and press **(●)**.  
The <Input Signal> menu appears.
- Select "Auto" or "Manual" with **(◀)** or **(▶)**, and press **(●)**.  
The Input Priority setting is completed.

# Chapter 4 Troubleshooting

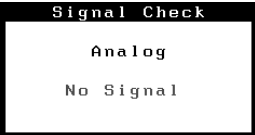
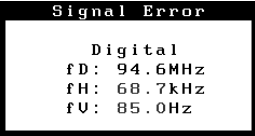
If a problem still remains after applying the suggested remedies, contact your local dealer.

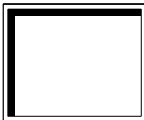
- No-picture problems → See No.1 - No.2.
- Imaging problems → See No.3 - No.11.
- Other problems → See No.12 - No.13.
- Touch panel problems → See No.14 - No.17.

Problems	Possible cause and remedy
<p><b>1. No picture</b></p> <ul style="list-style-type: none"> <li>• Power indicator does not light.</li> <li>• Power indicator is lighting blue.</li> <li>• Power indicator is lighting orange.</li> </ul>	<ul style="list-style-type: none"> <li>• Check whether the power cord is connected correctly.</li> <li>• Press .</li> <li>• Check &lt;Gain&gt; setting.</li> <li>• Switch the input signal with .</li> <li>• Operate the mouse or keyboard.</li> <li>• Turn on the PC.</li> </ul>
<p><b>2. The message below appears.</b></p> <ul style="list-style-type: none"> <li>• This message appears when no signal is input.</li> </ul>  <ul style="list-style-type: none"> <li>• The message below shows that the input signal is out of the specified frequency range. (Such signal frequency is displayed in red.) Example:</li> </ul> 	<p>This message appears when the signal is not input correctly even when the monitor functions properly.</p> <ul style="list-style-type: none"> <li>• The message shown left may appear, because some PCs do not output the signal soon after power-on.</li> <li>• Check whether the PC is turned on.</li> <li>• Check whether the signal cable is connected properly.</li> <li>• Switch the input signal with .</li> <li>• Select an appropriate display mode using the graphics board's utility software. Refer to the manual of the graphics board for details.</li> </ul>
<p><b>3. Display position is incorrect.</b></p> 	<ul style="list-style-type: none"> <li>• Adjust image position so that it is displayed properly within the display area using the &lt;Hor.Position&gt; and &lt;Ver.Position&gt; adjustment.</li> <li>• If the problem persists, use the graphics board's utility software if available to change the display position.</li> </ul>
<p><b>4. Vertical bars appear on the screen or a part of the image is flickering.</b></p> 	<ul style="list-style-type: none"> <li>• Adjust using &lt;Clock&gt;.</li> </ul>
<p><b>5. Whole screen is flickering or blurring.</b></p> 	<ul style="list-style-type: none"> <li>• Adjust using &lt;Phase&gt;.</li> </ul>
<p><b>6. Characters are blurred.</b></p>	<ul style="list-style-type: none"> <li>• Adjust using &lt;Smoothing&gt;.</li> </ul>
<p><b>7. The screen is too bright or too dark.</b></p>	<ul style="list-style-type: none"> <li>• Adjust &lt;Brightness&gt;. (The LCD monitor backlight has a fixed life span. When the screen becomes dark or begins to flicker, contact your local dealer.)</li> </ul>

Problems	Possible cause and remedy
<b>8. Afterimages appear.</b>	<ul style="list-style-type: none"> <li>• Use a screen saver or off timer function for a long-time image display.</li> <li>• Afterimages are particular to LCD monitors. Avoid displaying the same image for a long time.</li> </ul>
<b>9. Green/red/blue/white dots or defective dots remain on the screen.</b>	<ul style="list-style-type: none"> <li>• This is due to LCD panel characteristics and is not a failure.</li> </ul>
<b>10. The display image is appeared in lengthwise.</b>	<ul style="list-style-type: none"> <li>• Check whether the kind of cables connected with the monitor and the PC. (Connect the monitor and cables correctly by referring to “Connecting Cables” in Setup Manual (page 3).)</li> </ul>
<b>11. The Main menu of Adjustment menu does not start.</b>	<ul style="list-style-type: none"> <li>• Check for Adjustment Lock function.</li> <li>• Check whether the FineContrast menu is running. (Refer to “Simple adjustment [FineContrast mode]” on page 14.)</li> </ul>
<b>12. The auto-adjustment function does not work correctly.</b>	<ul style="list-style-type: none"> <li>• This function does not work when digital signal is input.</li> <li>• This function works correctly when an image is fully displayed over the display area. It does not work properly when an image is displayed only on a part of the screen (DOS prompt window, for example) or when a black background (wallpaper, etc.) is in use. This function does not work correctly with some graphics boards.</li> </ul>
<b>13. No audio output</b>	<ul style="list-style-type: none"> <li>• Check whether volume is set to “0”.</li> <li>• Check the settings of the PC and the audio playback software.</li> </ul>

#### Touch panel problems

Problems	Possible cause and remedy
<b>14. Cursor position is not correct. / Cursor jumps.</b>	<ul style="list-style-type: none"> <li>• Turn off and on the monitor. If the symptom is not improved, perform the calibration on the monitor.</li> <li>• Touch with one finger only.</li> <li>• Check whether “Swap X/Y” in the “Advanced” tab is checked in the Property settings of the touch panel driver. If the check is applied, the cursor may work incorrectly.</li> </ul>
<b>15. Touch operation is effective after turning off the monitor.</b>	<ul style="list-style-type: none"> <li>• For T1502, touch operation is effective until turning off both PC and monitor.</li> </ul>
<b>16. Touch operation is not effective.</b>	<ul style="list-style-type: none"> <li>• Check whether “EEPROM Calibration” in the “Calibration” tab is not checked in the Property settings of the touch panel driver. If the check is already applied, release the check before performing the calibration.</li> </ul>
<b>17. Some deflection may appear on the surface of touch panel portion.</b>	<ul style="list-style-type: none"> <li>• Due to the touch panel structural characteristics, the deflection may occur on the touch panel surface in high temperature/high humidity operating environment. This is not a trouble.</li> </ul>



# Chapter 5 Reference

## 5-1 Attaching an Arm

The stand can be removed and replaced with an arm (or another stand) to be attached to the monitor.

### [Attaching]

**1** Lay the LCD monitor on a soft cloth spread over on a stable surface with the panel surface facing down.

**2** Remove the stand. (Prepare a screwdriver.)

Unscrew the four screws securing the unit and the stand with the screwdriver.

**3** Attach the monitor to the arm or stand.

Secure the monitor to the arm or stand using the screws specified in the user's manual of the arm or stand.

- Clearance between the screw holes when attach an arm or stand:  
In case of 75mm x 75mm

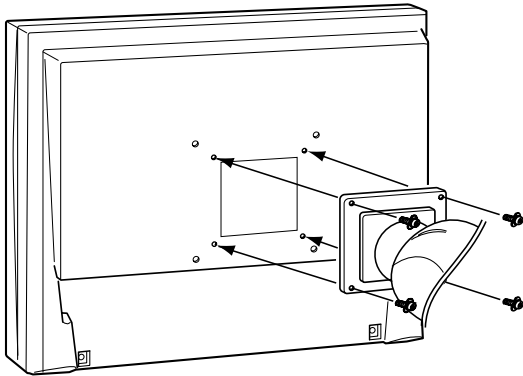

- Clearance between the screw holes when attach an arm or stand:  
In case of 100mm x 100mm

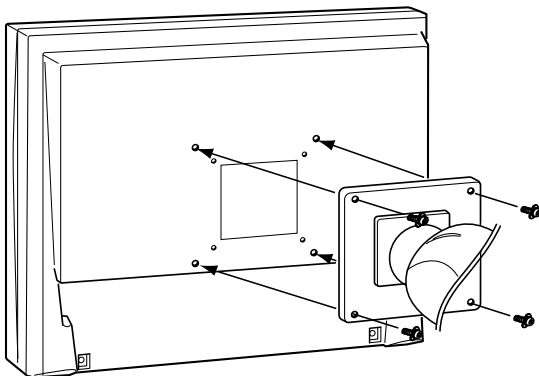

### Attention

- When attaching an arm or stand, follow the instructions of their user's manual.
- When using another manufacturer's arm or stand, confirm the following in advance and select one conforming to the VESA standard. Use M4 x 12 mm screws supplied with the monitor.
  - Clearance between the screw holes:  
75 mm x 75 mm or  
100 mm x 100 mm
  - Thickness of plate: 2.6 mm
  - Strong enough to support weight of the monitor unit (except the stand) and attachments such as cables.
- When using an arm or stand, attach it to meet the following tilt angles of the monitor.
  - Up 45 degrees, down 0 degrees (horizontal display)
- Connect the cables after attaching an arm.

## 5-2 Power Saving Mode

### ■ Analog input

This monitor complies with the VESA DPMS standard.

#### [Power Saving System]

PC		Monitor	Power Indicator
Operating		Operating	Blue
Power saving	STAND-BY SUSPENDED OFF	Power saving	Orange

#### [Resumption Procedure]

- Operate the mouse or keyboard to resume the normal screen.

### ■ Digital input

This monitor complies with the DVI DMPM standard.

#### [Power Saving System]

The monitor enters the power saving mode in five seconds in connection with the PC setting.

PC	Monitor	Power Indicator
Operating	Operating	Blue
Power saving	Power saving	Orange

#### [Resumption Procedure]

- Operate the mouse or keyboard to resume the normal screen.

## 5-3 Cleaning

Clean the monitor periodically to keep the monitor clean and extend its life.

### Cabinet

Clean the cabinet with a soft cloth dampened with little mild detergent.

### Panel

- Clean the panel with a soft cloth such as cotton cloth or lens cleaning paper.
- Remove persistent stains gently with a cloth dampened with little water, and then clean the panel again with a dry cloth for better finishing.

#### Attention

- Unplugging the power cord completely shuts off power supply to the monitor.
- Do not setup Standby function for the PC. When the PC is under the standby status, the monitor is not resumed by the touch operation.
- When the monitor is not resumed by the touch operation, operate the mouse or keyboard.

#### Attention

- Never use any solvents or chemicals, such as thinner, benzene, wax, alcohol, and abrasive cleaner, which may damage the cabinet or panel.
- Do not soak liquid into the clearance between the panel and the panel frame.

#### NOTE

- Optional ScreenCleaner is recommended for cleaning the panel surface.

## 5-4 Specifications

LCD Panel		15-inch (38 cm) TFT color LCD with anti-glare hard coating Viewing angle: Vertical 135°, Horizontal 150° (CR: 10 or more)
Dot Pitch		0.297 mm
Horizontal Scan Frequency		Analog: 24.8 - 60 kHz Digital: 31 - 49 kHz
Vertical Scan Frequency		Analog: 55 - 75 Hz (Non-interlace) Digital: 59 - 61 Hz, (VGA Text: 69 - 71 Hz) (Non-interlace)
Resolution		1024 dots × 768 lines
Max. Dot Clock		Analog: 80 MHz Digital: 65 MHz
Max. Display Colors		16.19 million colors
Display Area (H × V)		304.1 mm × 228.1 mm
Touch Panel	OS	Microsoft Windows 2000 Service Pack 4 Microsoft Windows XP Service Pack 2 (Not compatible with Mac OS)
	Communication protocol	RS-232C serial (T1501)/USB serial (T1502)
	Communication speed	9,600 bps (RS-232C)/Low speed (USB)
	Detective method	Analog resistive technology
Power Supply		100 - 120 VAC ±10% 50/60 Hz, 0.5 A 200 - 240 VAC ±10% 50/60 Hz, 0.3 A
Power Consumption		Maximum (usually): 21 W (speaker not working)/25 W (speaker working) Power saving mode: 1 W or less (for single signal input without USB, and no line input connector connected) Power switch Off: 1 W or less
Input Signal Connectors		DVI-D connector, D-sub mini 15-pin connector
Analog Input Signal (Sync)		H/V Separate, TTL, Positive/Negative
Analog Input Signal (Video)		0.7 Vp-p/75 Ω Positive
Digital Signal Transmission System		TMDS (Single Link)
Video Signal Memory		Analog Signal: 18 (preset: 13)
Audio output		Speaker output: 0.5 W + 0.5 W (8 Ω, THD: 10% or less) Headphone output: 2mW + 2mW
Line input		Input impedance 47 kΩ (typ.) Input level: 1.0 Vrms (Max.)
Plug & Play		VESA DDC 2B/EDID structure 1.3
Dimensions (Main unit)		346 mm (W) × 379.5 mm (H) × 175 mm (D) (13.6" (W) × 14.9" (H) × 6.9" (D))
Dimensions (without stand)		346 mm (W) × 280 mm (H) × 69 mm (D) (13.6" (W) × 11.0" (H) × 2.7" (D))
Weight (Main unit)		6.1 kg (13.4 lbs)
Weight (without stand)		4.1 kg (9.0 lbs)
Environmental Conditions	Temperature	Operating temperature: 0 °C - 35 °C Storage temperature: -20 °C - 60 °C
	Humidity	Relative humidity: 30% - 80% (no condensation)
USB Standard (T1502)		USB Specification Revision 1.1
USB Port (T1502)		Upstream port × 1

### Main default settings (factory settings)

BrightRegulator	Disable
Smoothing	3
FineContrast Mode	Custom
Input Signal	Auto
Off Timer	Disable
Language	English

### Outside Dimensions

unit : mm (inch)

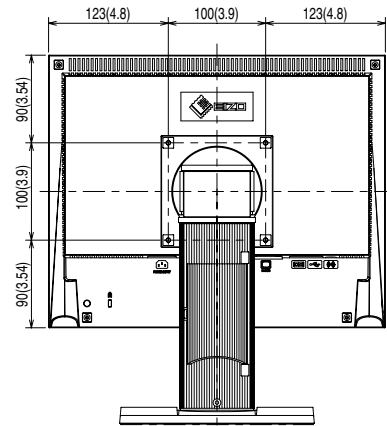
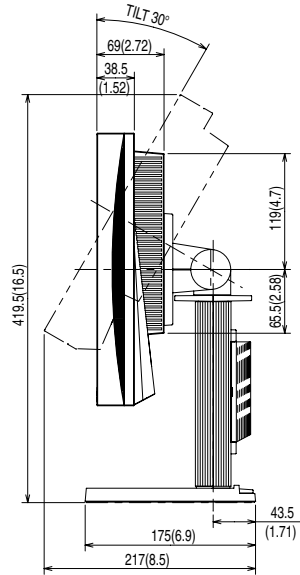
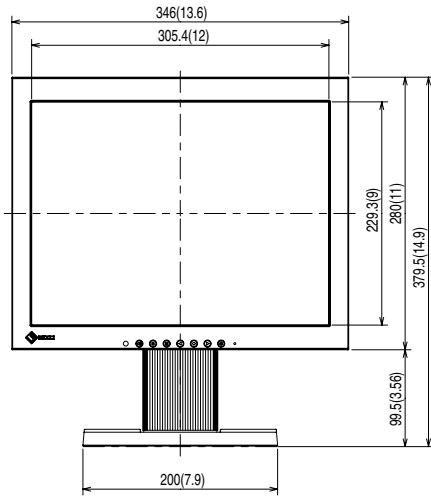
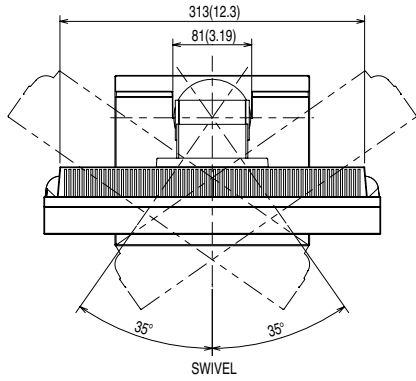

## Connector Pin Assignment

- DVI-D connector

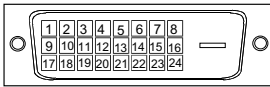

Pin No.	Signal	Pin No.	Signal	Pin No.	Signal
1	TMDS Data 2-	9	TMDS Data1-	17	TMDS Data 0-
2	TMDS Data 2+	10	TMDS Data1+	18	TMDS Data 0+
3	TMDS Data2/4 Shield	11	TMDS Data1/3 Shield	19	TMDS Data 0/5 Shield
4	NC*	12	NC*	20	NC*
5	NC*	13	NC*	21	NC*
6	DDC Clock (SCL)	14	+5V Power	22	TMDS Clock shield
7	DDC Data (SDA)	15	Ground (return for +5V, Hsync and Vsync)	23	TMDS Clock+
8	NC*	16	Hot Plug Detect	24	TMDS Clock-

(NC\*: No Connection)

- D-sub mini 15-pin connector

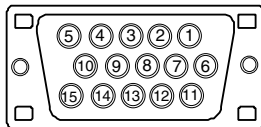

Pin No.	Signal	Pin No.	Signal	Pin No.	Signal
1	Red	6	Red ground	11	NC*
2	Green	7	Green ground	12	Data (SDA)
3	Blue	8	Blue ground	13	H. Sync
4	NC*	9	NC*	14	V. Sync
5	Ground	10	Ground	15	Clock (SCL)

(NC\*: No Connection)

- RS-232C port (Mini DIN 6 pin) (T1501)



Pin No.	Signal
1	TXD
2	CTS
3	RTS
4	GND
5	RXD
6	GND

- USB port (T1502)

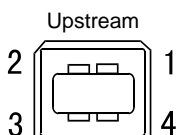

Contact No.	Signal	Remarks
1	VCC	Cable power
2	- Data	Serial data
3	+ Data	Serial data
4	Ground	Cable ground

## Option List

Cleaning Kit	EIZO ScreenCleaner
Touch Panel Pointer	TP1

## 5-5 Glossary

### **Clock**

The analog input monitor needs to reproduce a clock of the same frequency as the dot clock of the graphics system in use, when the analog input signal is converted to a digital signal for image display.

This is called clock adjustment. If the clock pulse is not set correctly, some vertical bars appear on the screen.

### **DVI (Digital Visual Interface)**

DVI is a digital interface standard. DVI allows direct transmission of the PC's digital data without loss.

This adopts the TMDS transmission system and DVI connectors. There are two types of DVI connectors. One is a DVI-D connector for digital signal input only. The other is a DVI-I connector for both digital and analog signal inputs.

### **DVI DMPM (DVI Digital Monitor Power Management)**

DVI DMPM is a digital interface power-saving function. The "Monitor ON (operating mode)" and "Active Off (power-saving mode)" are indispensable for DVI DMPM as the monitor's power mode.

### **Gain**

This is used to adjust each color parameter for red, green and blue. An LCD monitor displays the color by the light passing through the panel color filter. Red, green and blue are the three primary colors. All the colors on the screen are displayed by combining these three colors. The color tone can be changed by adjusting the light intensity (volume) passing through each color's filter.

### **Gamma**

Generally, the monitor brightness varies nonlinearly with the input signal level, which is called "Gamma Characteristic". A small gamma value produces a low-contrast image, while a large gamma value produces a high-contrast image.

### **Phase**

Phase means the sampling timing to convert the analog input signal to a digital signal. Phase adjustment is made to adjust the timing. It is recommended that phase adjustment be made after the clock is adjusted correctly.

### **Range Adjustment**

Range adjustment controls the signal output levels to display every color gradation. It is recommended that range adjustment be made before color adjustment.

### **Resolution**

The LCD panel consists of numerous pixels of specified size, which are illuminated to form images. This monitor consists of 1024 horizontal pixels and 768 vertical pixels. At a resolution of 1024 × 768, all pixels are illuminated as a full screen (1:1).

### **sRGB (Standard RGB)**

International standard for "color reproduction and color space" among peripheral devices (such as monitors, printers, digital cameras, scanners). sRGB allows Internet users to closely match colors as a simple color matching means for the Internet use.

### **Temperature**

Color temperature is a method to measure the white color tone, generally indicated in degrees Kelvin. The screen becomes reddish at a low temperature, and bluish at a high temperature, like the flame temperature.

5000K: Slightly reddish white

6500K: Warm white like paper white

9300K: Slightly bluish white

### **TMDS (Transition Minimized Differential Signaling)**

A signal transmission system for digital interface.

### **VESA DPMS (Video Electronics Standards Association - Display Power Management Signaling)**

VESA provides the standardization of signals from PC (graphics board) for power saving of PC monitors. DPMS defines the signal status between PC and monitor.

## 5-6 Preset Timing

The following table shows factory preset video timing (for analog signal only).

Mode	Dot clock		Frequency	Polarity
			Horizontal: kHz Vertical: Hz	
VGA 640x480@60Hz	25.2 MHz	Horizontal	31.47	Negative
		Vertical	59.94	Negative
VGA 720x400@70Hz	28.3 MHz	Horizontal	31.47	Negative
		Vertical	70.09	Positive
PC-9801 640x400@56Hz	21.1 MHz	Horizontal	24.83	Negative
		Vertical	56.42	Negative
PC-9821 640x400@70Hz	25.2 MHz	Horizontal	31.48	Negative
		Vertical	70.10	Negative
VESA 640x480@72Hz	31.5 MHz	Horizontal	37.86	Negative
		Vertical	72.81	Negative
VESA 640x480@75Hz	31.5 MHz	Horizontal	37.50	Negative
		Vertical	75.00	Negative
VESA 800x600@56Hz	36.0 MHz	Horizontal	35.16	Positive
		Vertical	56.25	Positive
VESA 800x600@60Hz	40.0 MHz	Horizontal	37.88	Positive
		Vertical	60.32	Positive
VESA 800x600@72Hz	50.0 MHz	Horizontal	48.08	Positive
		Vertical	72.19	Positive
VESA 800x600@75Hz	49.5 MHz	Horizontal	46.88	Positive
		Vertical	75.00	Positive
VESA 1024x768@60Hz	65.0 MHz	Horizontal	48.36	Negative
		Vertical	60.00	Negative
VESA 1024x768@70Hz	75.0 MHz	Horizontal	56.48	Negative
		Vertical	70.07	Negative
VESA 1024x768@75Hz	78.8 MHz	Horizontal	60.02	Positive
		Vertical	75.03	Positive

### Attention

- Display position may be deviated depending on the PC connected, which may require screen adjustment using Adjustment menu.
- If a signal other than those listed in the table is input, adjust the screen using the Adjustment menu. However, screen display may still be incorrect even after the adjustment.
- When interlace signals are used, the screen cannot be displayed correctly even after screen adjustment using the Adjustment menu.

For U.S.A. , Canada, etc. (rated 100-120 Vac) Only

## FCC Declaration of Conformity

**We, the Responsible Party**

EIZO NANAOTECHNOLOGIES INC.

5710 Warland Drive, Cypress, CA 90630

Phone: (562) 431-5011

**declare that the product**

Trade name: EIZO

Model: FlexScan T1501/T1502

**is in conformity with Part 15 of the FCC Rules. Operation of this product is subject to the following two conditions: (1) this device may not cause harmful interference, and (2) this device must accept any interference received, including interference that may cause undesired operation.**

This equipment has been tested and found to comply with the limits for a Class B digital device, pursuant to Part 15 of the FCC Rules. These limits are designed to provide reasonable protection against harmful interference in a residential installation. This equipment generates, uses, and can radiate radio frequency energy and, if not installed and used in accordance with the instructions, may cause harmful interference to radio communications. However, there is no guarantee that interference will not occur in a particular installation. If this equipment does cause harmful interference to radio or television reception, which can be determined by turning the equipment off and on, the user is encouraged to try to correct the interference by one or more of the following measures.

- \* Reorient or relocate the receiving antenna.
- \* Increase the separation between the equipment and receiver.
- \* Connect the equipment into an outlet on a circuit different from that to which the receiver is connected.
- \* Consult the dealer or an experienced radio/TV technician for help.

Changes or modifications not expressly approved by the party responsible for compliance could void the user's authority to operate the equipment.

### Note

Use the attached specified cable below or EIZO signal cable with this monitor so as to keep interference within the limits of a Class B digital device.

- AC Cord
- Shielded Signal Cable (enclosed)

## Canadian Notice

This Class B digital apparatus complies with Canadian ICES-003.

Cet appareil numérique de la classe B est conforme à la norme NMB-003 du Canada.



### **Hinweise zur Auswahl des richtigen Schwenkarms für Ihren Monitor**

Dieser Monitor ist für Bildschirmarbeitsplätze vorgesehen. Wenn nicht der zum Standardzubehör gehörige Schwenkarm verwendet wird, muss statt dessen ein geeigneter anderer Schwenkarm installiert werden. Bei der Auswahl des Schwenkarms sind die nachstehenden Hinweise zu berücksichtigen:

Der Standfuß muß den nachfolgenden Anforderungen entsprechen:

- a) Der Standfuß muß eine ausreichende mechanische Stabilität zur Aufnahme des Gewichtes vom Bildschirmgerät und des spezifizierten Zubehörs besitzen. Das Gewicht des Bildschirmgerätes und des Zubehörs sind in der zugehörigen Bedienungsanleitung angegeben.
- b) Die Befestigung des Standfusses muß derart erfolgen, daß die oberste Zeile der Bildschirmanzeige nicht höher als die Augenhöhe eines Benutzers in sitzender Position ist.
- c) Im Fall eines stehenden Benutzers muß die Befestigung des Bildschirmgerätes derart erfolgen, daß die Höhe der Bildschirmmitte über dem Boden zwischen 135 – 150 cm beträgt.
- d) Der Standfuß muß die Möglichkeit zur Neigung des Bildschirmgerätes besitzen (max. vorwärts: 5°, min. nach hinten  $\geq 5^\circ$ ).
- e) Der Standfuß muß die Möglichkeit zur Drehung des Bildschirmgerätes besitzen (max.  $\pm 180^\circ$ ). Der maximale Kraftaufwand dafür muß weniger als 100 N betragen.
- f) Der Standfuß muß in der Stellung verharren, in die er manuell bewegt wurde.
- g) Der Glanzgrad des Standfusses muß weniger als 20 Glanzeinheiten betragen (seidenmatt).
- h) Der Standfuß mit Bildschirmgerät muß bei einer Neigung von bis zu 10° aus der normalen aufrechten Position kippstabil sein.

„Maschinenlärminformations-Verordnung 3. GPSGV:

Der höchste Schalldruckpegel beträgt 70 dB(A) oder weniger gemäss EN ISO 7779“

Nicht für Bildschirm - Arbeitsplätze geeignet



### **EIZO NANA O CORPORATION**

153 Shimokashiwano, Hakusan, Ishikawa 924-8566 Japan  
Phone: +81 76 277 6792 Fax: +81 76 277 6793

### **EIZO NANA O TECHNOLOGIES INC.**

5710 Warland Drive, Cypress, CA 90630, U.S.A.  
Phone: +1 562 431 5011 Fax: +1 562 431 4811

### **EIZO EUROPE AB**

Lovangsvagen 14 194 61, Upplands Väsby, Sweden  
Phone: +46 8 590 80 000 Fax: +46 8 590 91 575

### **EIZO NANA O AG**

Moosacherstrasse 6, Au CH - 8820 Wadenswil, Switzerland  
Phone: +41-0-44 782 24 40 Fax: +41-0-44 782 24 50

### **Avnet Technology Solutions GmbH**

Lötscher Weg 66, D-41334 Nettetal, Germany  
Phone: +49 2153 733-400 Fax: +49 2153 733-483

<http://www.eizo.com>



2nd Edition-June, 2007

03V22094B1  
(U.M-T1501)