

GRACO®

Highchair

Owner's Manual • Please save for future use.

Chaise haute

Manuel d'utilisateur
Veuillez garder pour usage ultérieur.

Silla alta

Manual del propietario
Por favor, conservélo para utilizarlo en el futuro.

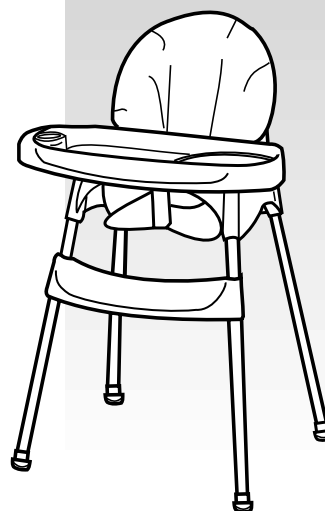

3180

Model • Modèle • Modelo: _____ **Serial No. • No. de Série • N° de Serie:** _____

Dear Customer,

Please fill in the model and serial numbers above from the label on the bottom of the seat of your new highchair.

Thank you for purchasing this Graco® highchair!

Graco is the recognized leader in the design and manufacture of quality baby products. We believe your new Graco highchair is a wise choice, promising many hours of enjoyment for your baby.

Before using your highchair, please take a few minutes to read this Owner's Manual. The short time you spend reading these instructions will help you use your highchair properly.

Cher Client,

Veuillez inscrire ci-haut les numéros de modèle et de série que vous trouverez sur l'étiquette en dessous du siège de votre nouvelle chaise haute.

Merci de votre achat d'une chaise haute Graco!®

Graco est le chef de file dans la conception et la fabrication de produits de qualité pour bébé. Nous croyons que la chaise haute Graco est un choix judicieux, garantissant plusieurs heures de plaisir pour votre bébé.

Avant d'utiliser la chaise haute, prenez quelques minutes pour lire le manuel d'utilisateur. Ce court instant que vous prendrez à lire les instructions vous aidera à utiliser correctement la chaise haute.

Estimado cliente,

Complete los números de modelo y de serie arriba indicados, de la etiqueta debajo del asiento de su nueva silla alta.

Gracias por comprar esta silla alta Graco!®

Graco es el líder reconocido en el diseño y fabricación de productos infantiles de calidad. Creemos que su silla alta Graco es una compra acertada y ofrecerá a su bebé muchas horas de placer.

Antes de usar su silla alta, dedique unos minutos a leer este manual del propietario. El poco tiempo que emplee en leer estas instrucciones le ayudará a utilizar su silla alta de manera correcta.

⚠ WARNING

Failure to follow these warnings and the assembly instructions could result in serious injury or death.

- **NEVER LEAVE CHILD UNATTENDED.** Always keep your child in view.
- **PREVENT SERIOUS INJURY OR DEATH FROM FALLS OR SLIDING OUT.** Always use seat belt. Secure your child at all times with the restraint system provided. The tray is not designed to hold your child in the highchair. It is recommended that the highchair be used only by children capable of sitting upright unassisted.
- **DO NOT FORCE TRAY** against child. Use only the four adjustment positions. Be sure both adjustment fingers are engaged in armrest slots.
- **STRANGULATION HAZARD:** Do not place highchair in any location where there are cords, such as window blind cords, drapes, phone cords, etc.
- **THIS HIGHCHAIR IS DESIGNED TO BE USED BY A CHILD UP TO 3 YEARS OF AGE.** Maximum weight 37 pounds (16.8 kg).
- **FOLLOW ASSEMBLY INSTRUCTIONS CAREFULLY.** If you experience any difficulties, please contact the Customer Service Department.
- **DISCONTINUE USING YOUR HIGHCHAIR** should it become damaged or broken.

⚠ MISE EN GARDE

Manquer de suivre ces avertissements et les instructions d'assemblage peut entraîner de sérieuses blessures ou un décès.

- **NE JAMAIS LAISSER L'ENFANT SANS SUPERVISION.** Gardez toujours l'enfant à vue.
- **PREVEZ LES BLESSURES SÉRIEUSES OU LA MORT EN TOMBANT OU EN GLISSANT HORS DE LA CHAISE HAUTE.** Toujours attacher votre enfant avec la ceinture de retenue. Votre enfant devrait être attaché avec la ceinture de retenue dans la chaise haute en tous temps. Le plateau n'est pas conçu pour retenir votre enfant. Il est recommandé que la chaise haute soit utilisée pour les enfants pouvant s'asseoir sans assistance.
- **NE PAS FORCER LE PLATEAU CONTRE L'ENFANT.** Employez seulement les quatre positions d'ajustement. Assurez-vous que toutes les tiges d'ajustement sont dans les fentes de l'accoudoir.
- **DANGER D'ÉTRANGLEMENT:** Ne pas installer la chaise haute à un endroit où il y a des cordons, tels les stores, les rideaux, ou téléphones, etc.
- **LA CHAISE HAUTE EST UTILISÉ PAR UN ENFANT ÂGÉ JUSQU'À 3 ANS.** Poids maximum de 37 livres (16,8 kg).
- **SUIVRE LES INSTRUCTIONS D'ASSEMBLAGE SOIGNEUSEMENT.** Si vous rencontrez des difficultés, contactez le département du service à la clientèle.
- **CESSEZ L'UTILISATION DE VOTRE CHAISE HAUTE** si elle est endommagée ou cassée.

⚠ ADVERTENCIA

Si no obedecen estas advertencias y se siguen las instrucciones de montaje podría resultar en lesiones graves o la muerte.

- **NUNCA DEJE A SU NIÑO DESATENDIDO.** Siempre tenga su niño a la vista.
- **EVITE SERIAS LESIONES CAUSADAS POR CAÍDAS O DESPLAZAMIENTOS.** Use siempre el cinturón de seguridad. Asegure a su niño en todo momento con el sistema de seguridad provisto, en la posición reclinada o vertical. La bandeja no ha sido diseñada para soportar a su niño en la silla alta. Se recomienda que solamente niños capaz de sentarse en posición vertical sin ayuda usen la silla alta.
- **NO FUERCE LA BANDEJA CONTRA EL NIÑO.** Use solamente las cuatro posiciones de ajuste. Asegúrese de que ambos dedos de ajuste están trabados en las ranuras de los apoyabrazos.
- **PELIGRO ESTRANGULACIÓN:** No coloque la silla alta en cualquier lugar donde haya cordones, tales como cordones de persianas, cortinas, teléfonos, etc.
- **ESTA SILLA ALTA ESTÁ DISEÑADA SER USADA POR UN NIÑO DE 3 AÑOS DE EDAD COMO MÁXIMO.** Con un peso máximo de 37 libras (16,8 kg).
- **SIGA LAS INSTRUCCIONES DE ENSAMBLAJE CUIDADOSAMENTE.** Si experimenta alguna dificultad, por favor, contacte al Departamento de Servicio al Cliente.
- **DEJE DE USAR SU SILLA ALTA** si ésta se daña o rompe.

Questions?

In the U.S.A. or Canada, please contact our Customer Service Department with any questions you may have concerning parts, use, or maintenance. When you contact us, please have your product's **model and serial numbers** ready so that we may help you efficiently.



Telephone us at:
Téléphonez-nous au:
Llámenos al:

USA: 1-800-345-4109
Canada: 1-800-667-8184
Montreal: 514-344-3533

Des questions?

Aux Etats-Unis ou au Canada, veuillez contacter notre département du service à la clientèle avec des questions que vous pourriez avoir concernant les pièces, l'utilisation ou l'entretien. Lorsque vous nous contactez, soyez prêt à fournir les **numéros de modèle et de série** afin que nous puissions vous aider plus rapidement.



or visit our website,
ou visitez notre website,
o visite nuestro sitio Web,

USA: www.gracobaby.com
Canada: www.graco.net

¿Preguntas?

En los EE.UU. y Canadá, por favor contacte a nuestro Departamento de Servicio al Cliente con cualquier pregunta que pueda tener sobre las piezas, uso o mantenimiento. Cuando nos contacte, por favor tenga el **número del modelo y número de serie** listos para que podamos ayudarlo mejor.



or write to us at:
sinon, écrivez-nous à:
o escribanos a:

USA:
Graco Children's Products Inc.
Customer Service Department
P.O. Box 100, Main Street
Elverson, PA 19520



Canada: distributed by
Elfe
4580 Hickmore
St. Laurent, Quebec H4T 1K2

Parts list

Check that you have all the parts shown **BEFORE** assembling your product. If any parts are missing, call Customer Service.

Adult assembly required.

Tools required: Screwdriver

Liste des pièces

Assurez-vous d'avoir toutes les pièces illustrées **AVANT** de commencer l'assemblage de votre produit. S'il vous manque des pièces, communiquez avec notre service à la clientèle.

Assemblage par un adulte requis.

Outils nécessaires: Tournevis

Lista de las piezas

Verifique que cuenta con todas las piezas mostradas **ANTES** de montar su producto. Si falta alguna pieza, llame al Departamento de Servicio al Cliente.

Se requiere montaje por un adulto.

Herramienta necesaria: Destornillador

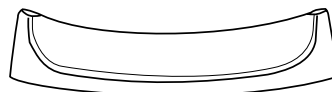
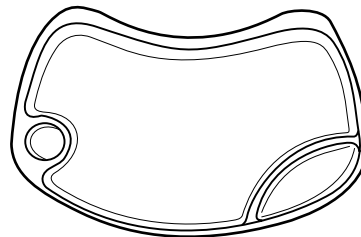
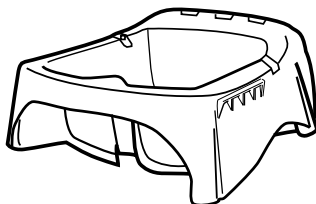
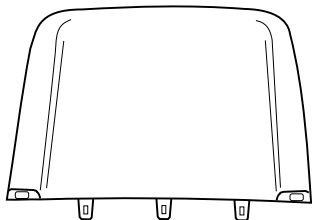

2X

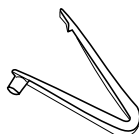
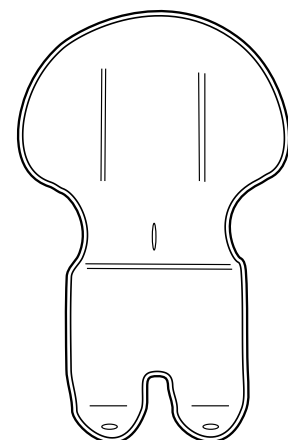

4X

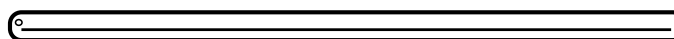

4X



4X

Assembly

This exploded view is provided as a way to help you see the overall picture as you are assembling your product. It is not meant to replace the step-by-step instructions.

Assemblage

Cette illustration agrandie est fournie pour vous aider à voir l'image totale lors de l'assemblage de votre produit. Cette illustration ne doit pas remplacer les instructions étape par étape.

Montaje

Se proporciona este plano detallado para darle una perspectiva global del montaje de su producto. No está destinado a remplazar las instrucciones paso por paso.

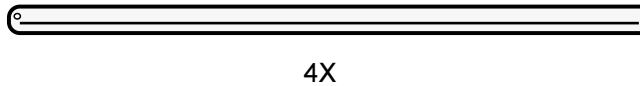
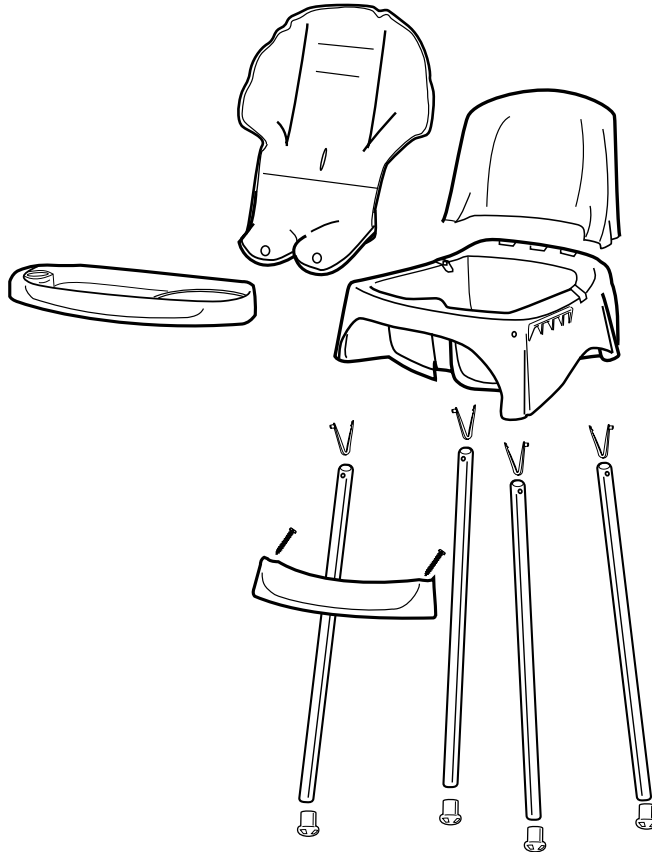

1

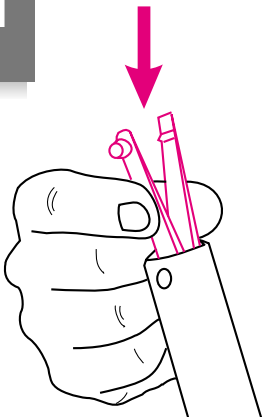

2

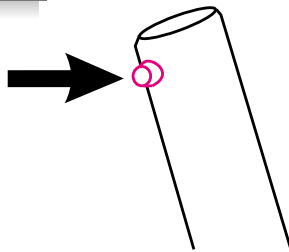

The button **MUST** pop out of the hole in the leg tube as shown.

Le bouton **DOIT** ressortir du trou dans le tube du pied de base tel qu'illustré.

El botón **DEBE** saltar del agujero en el tubo de la pata como se indica.

3

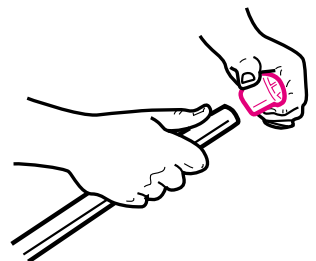

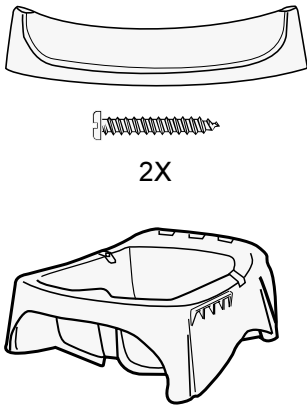

4

Back legs
Pieds de base arrière
Patatas traseras

5

Button **MUST** snap through hole in seat.
Bouton **DOIT** s'enclencher à travers le trou du siège.
El botón **DEBE** trabarse a través del agujero en el asiento.

If fit on leg is too tight, rub a drop of **hand soap** on end of leg tubes before inserting them.

Si l'ajustement sur le pied de base est trop serré, frottez une goutte de **savon** à main sur l'extrémité des tubes des pieds base avant de les insérer.

Si cabe demasiado ajustada en la pierna, frotar una pequeña cantidad de **jabón** en el extremo de los tubos para las piernas antes de insertarlos.

6

7

8

Front of seat
Devant du siège
Parte delantera del asiento

9

10

CHECK that all legs are secure by pulling up firmly on legs.

VÉRIFIEZ que tous les pieds de base sont solides en tirant fermement.

VERIFIQUE que todas las patas están aseguradas tirando hacia arriba firmemente de las patas.

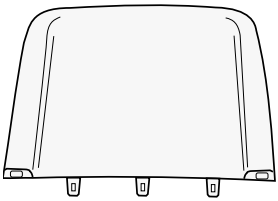

11

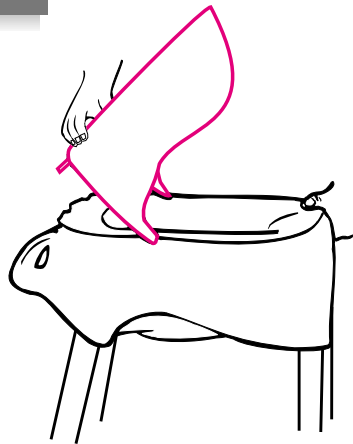

12

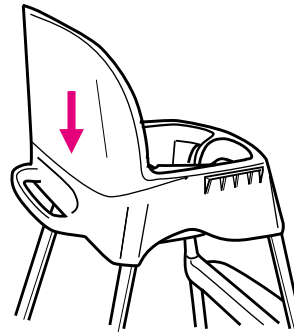

Pull up on seat back to make sure it is attached properly.

Tirez sur le dossier du siège pour vous assurer qu'il est attaché correctement.

Tire hacia arriba el respaldo del asiento para asegurarse que esté debidamente conectado.

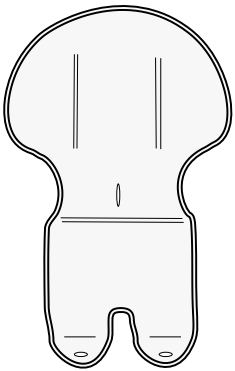

13

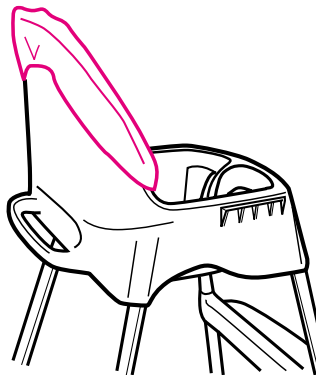

14

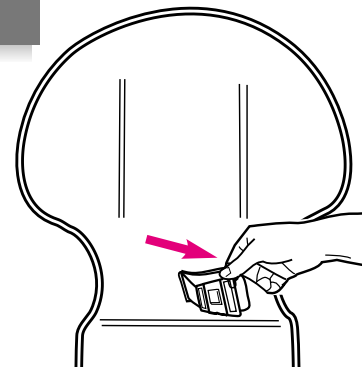

15

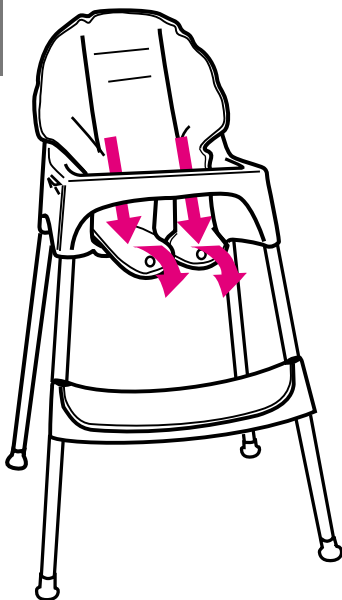

16

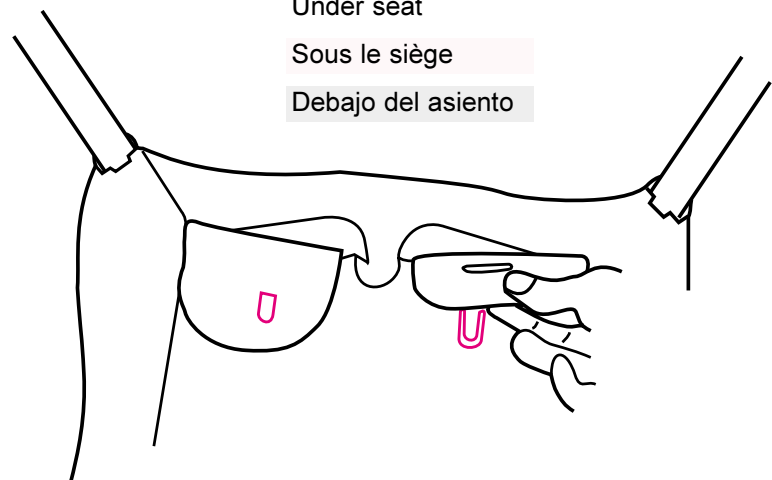

Under seat

Sous le siège

Debajo del asiento

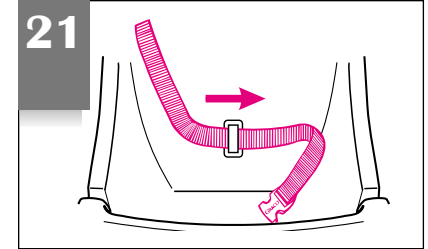
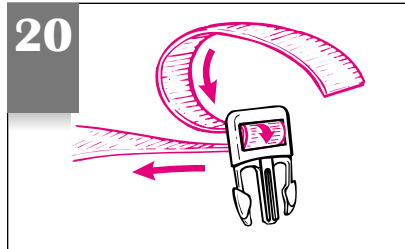
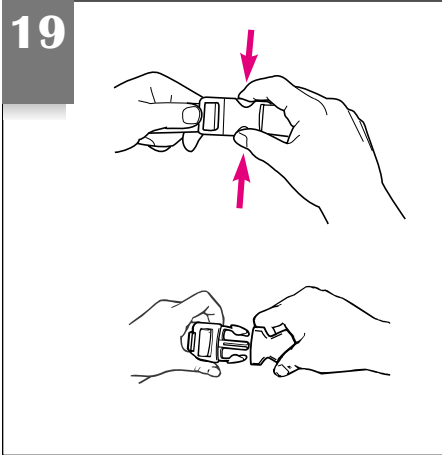
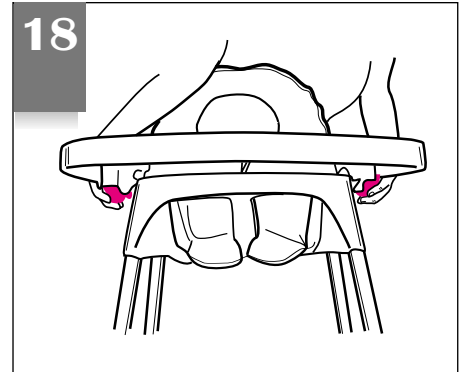
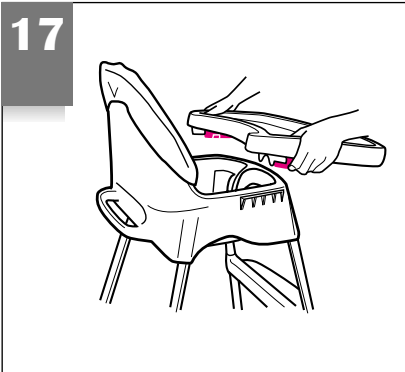
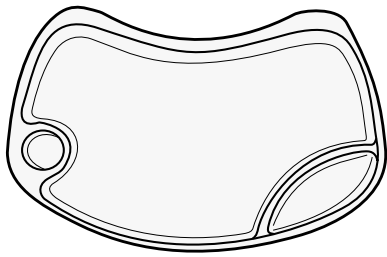

To remove the seat belt, follow steps 20 and 21. To rethread buckle, reverse steps.

CHECK by pulling on seat belt. **Belt should not slip.**

Pour enlever la ceinture de retenue, suivre les étapes 20 et 21. Pour enfiler la boucle, suivre les étapes à l'inverse.

VÉRIFIEZ en tirant sur la ceinture de retenue. **La ceinture ne doit pas glisser.**

Para sacar el cinturón de seguridad, cumpla los pasos 20 y 21. Para volver a enroscar la hebilla, invierta los pasos.

VERIFIQUELO tirando del cinturón de seguridad. **El cinturón no deberá desatarse.**

Care and Maintenance

FROM TIME TO TIME CHECK YOUR HIGHCHAIR for worn parts, torn vinyl or stitching. Replace or repair the parts as needed. Use only Graco replacement parts.

TO CLEAN HIGHCHAIR FRAME, use only household soap and warm water. **NO BLEACH** or detergent.

Soin et entretien

INSPECTEZ VOTRE CHAISE-HAUTE PÉRIODIQUEMENT pour des pièces usées, vinyle déchiré ou décousu. Remplacez ou réparez au besoin. Utilisez seulement les pièces de remplacement Graco.

POUR NETTOYER L'ARMATURE DE LA CHAISE-HAUTE, utilisez seulement du savon de ménage avec de l'eau tiède. **AUCUN AGENT DE BLANCHIMENT** ou détergent.

Cuidado y mantenimiento

DE VEZ EN CUANDO INSPECCIONE LAS SILLA ALTA para determinar si hay tornillos sueltos, partes gastadas o materiales rotos. Cambie o repare las piezas según sea necesario. Use solamente repuestos Graco.

PARA LIMPIAR EL BASTIDOR DE SU SILLA ALTA utilice únicamente jabón y agua tibia. **NO UTILICE CLORO** o detergente doméstico.

Replacement Parts (USA)

Complete the form below. Your high chair model number **MUST** be included on the form to ensure proper replacement parts. **Your model number can be found on the bottom of the seat of the highchair. Payment must accompany your order.**

Return the form with payment to:
GRACO Children's Products Inc.
Customer Service Department
P.O. BOX 100, Main Street
Elverson, PA 19520



Questions? Telephone us at: • ¿Preguntas? Llámenos al:

1-800-345-4109

Piezas de repuesto (EE.UU)

Complete el formulario a continuación. El número de modelo de su silla alta **DEBE** de incluirse en este formulario para asegurar las piezas de repuesto apropiadas. **Su número de modelo se puede encontrar debajo del asiento de su nueva silla alta. El pago en dólares estadounidenses debe incluirse con el pedido.**

Devuélvase con pago a:
GRACO Children's Products Inc.
Customer Service Department
P.O. BOX 100, Main Street
Elverson, PA 19520

Replacement Parts (Canada)



To purchase parts in Canada, contact Elfe at
1-800-667-8184
 (Montreal: 514-344-3533
 Fax: 514-344-9296).

Des pièces de remplacement (au Canada)



Pour commander les pièces au Canada, communiquez avec Elfe au
1-800-667-8184
 (Montréal: 514-344-3533
 Fax: 514-344-9296).

• Circle the part you need.

• Marque con un círculo el repuesto que necesita.

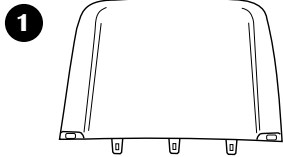

\$10.00

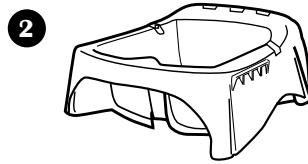

\$15.00

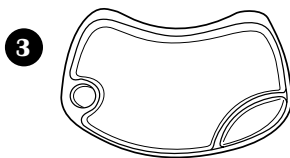

\$12.00

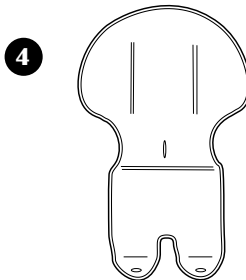

\$10.00



\$8.00



\$8.00 (1)

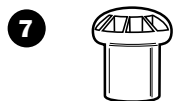

\$2.50 (1) / \$5.00 (4)

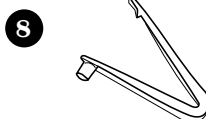

no charge
sin costo

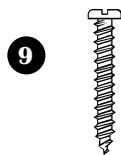

no charge
sin costo

Must be filled in: Debe completarse:

Model No.
N° de modelo

Serial No.
N° de serie

Total • Total:

Shipping & handling*:
Gastos de envío*: \$5.00

Sales tax**:
Impuestos**:

Total due:

Total a pagar:

*\$15.00 outside the continental U.S.

**US\$ 15,00 para fuera del continente de EE.UU

**CA 6%, IL 6.25%, IN 5%, NY 8.25%,

OH 5.75%, PA 6%, SC 5%

Ship to • Enviar a:

Name • Nombre

Address • Dirección

City, State, Zip • Ciudad, Estado, Código postal

Telephone • Teléfono

Check or money order enclosed
(payable to Graco Children's Products Inc.)

Cheque o giro adjunto

(a nombre de Graco Children's Products Inc.)

Charge to credit card • Cargar a la tarjeta de crédito

Account #: • Cuenta N°:

Visa

Exp. date • Fecha de vencimiento:

Mastercard

Signature • Firma:

Discover

IMPORTANT!

PRODUCT REGISTRATION CARD

THANK YOU
FOR CHOOSING
GRACO®

Please take a moment to
complete this card today to:

- ▶ REGISTER
YOUR
PRODUCT
- ▶ RECEIVE
FUTURE
INFORMATION
- ▶ HELP US
DEVELOP NEW
PRODUCTS

Please send other correspondence to:

Graco Children's Products Inc.
Main Street
P.O. Box 100
Elverson, PA 19520-0100

238 A

GRACO®
PRODUCT REGISTRATION DEPARTMENT
PO BOX 40
DENVER CO 80201-0040

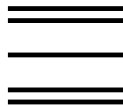

Place
First-Class
Stamp
Here
Post Office will
not deliver
without proper
postage





Thank you for your purchase of a Graco product. Your input regarding this product is very important to us.

Return this card today to:

1 REGISTER YOUR PRODUCT

We will keep the model number, serial number, and date of purchase of your Graco product on file.

2 RECEIVE FUTURE INFORMATION

By returning this card, you will help us to notify you of any issues concerning this product.

3 HELP US DEVELOP NEW PRODUCTS

We value your input. Your responses will help us develop new products specifically designed to meet your needs.

DETACH HERE BEFORE MAILING

IMPORTANT! Product Registration Card IMPORTANT!

1. Mr. 2. Mrs. 3. Ms. 4. Miss

First Name: _____ Initial: _____ Last Name: _____

Address: (Number and Street) _____ Apt. #: _____

City: _____ State: _____ Zip Code: _____

2. Phone #: _____

3. I am a:
 1. Parent 2. Grandparent

4. Store Name: _____

5. Date of Purchase: _____
 Month Day Year

6. Record Model Number and Serial Number:
 (These can be found on the white label on the product)

Model Number: _____

Serial Number: _____

7. Was this purchase a:
 1. Gift? 2. Self purchase?

8. Is this your first child?
 1. Yes 2. No

9. In what trimester was your purchasing decision made?
 1. 1st 2. 2nd 3. 3rd

10. This child is:
 1. Male 2. Female

11. How did you first hear about this Graco product?
 1. Word of Mouth 5. Store Flyer
 2. Salesperson 6. Catalog
 3. In-Store Display 7. Other
 4. Magazine Ad

12. Check the three (3) most important reasons why you purchased this Graco product:
 1. Received as a Gift
 2. Fabric Design / Appearance
 3. Frame Design / Style
 4. Graco Reputation
 5. Recommendation of Salesperson
 6. Recommendation of Friend / Family
 7. Value for Price
 8. Magazine Advertisement
 9. Ease of Operation
 10. Light Weight
 11. Product Features
 12. Sale / Promotion
 13. Prior Experience with Graco

13. What other brands did you consider?
 1. Graco was the only brand considered
 2. Century 6. Fisher Price
 3. Combi 7. Gerry
 4. Cosco 8. Other _____
 5. Evenflo

14. Have you purchased Graco products before?
 1. Yes 2. No

15. Where do you and your family do most of your shopping?
 1. Shopping Mall
 2. Discount Store
 3. Specialty Store

16. Baby's date of birth: (or due date) _____
 Month Day Year

17. Date of Your birth: _____
 Month Day Year

18. For your primary residence, do you:
 1. Own? 2. Rent?

19. Your marital status:
 1. Married 2. Single

20. Education (Please check which category applies):
 1. High School 3. Completed College
 2. Some College 4. Graduate School

21. Including yourself, what is the total number of people living in your household? _____
 (Examples: 01, 02, 03, 04...)

22. NOT including yourself, what are the AGES of the other people living in your household?
 Age (in years)
 Male: _____
 Female: _____

23. Which best describes your family income?
 1. Under \$15,000 5. \$50,000-\$74,999
 2. \$15,000-\$24,999 6. \$75,000-\$100,000
 3. \$25,000-\$34,999 7. \$100,000-\$149,999
 4. \$35,000-\$49,999 8. Over \$150,000

24. In the last 6 months have you or your spouse:
 1. Purchased clothes through the mail?
 2. Purchased gifts through the mail?
 3. Worked in your garden?
 4. Traveled on vacation?
 5. Purchased through television shopping?
 6. Purchased two or more books?
 7. Purchased cassettes or CDs?
 8. Donated to wildlife / environmental causes?
 9. Donated to charities?

Thanks for taking time to fill out this questionnaire. Please check here [] if you do not wish to learn more about Graco or obtain information on new ideas from other exciting companies.