

User's Manual

FlexScan® L568/L568-AS

Color LCD Monitor

Important

Please read this User's Manual carefully to familiarize yourself with safe and effective usage procedures. Please retain this manual for future reference.



SAFETY SYMBOLS

This manual uses the safety symbols below. They denote critical information. Please read them carefully.



WARNING

Failure to abide by the information in a WARNING may result in serious injury and can be life threatening.



CAUTION

Failure to abide by the information in a CAUTION may result in moderate injury and/or property or product damage.



Indicates a prohibited action.



Indicates to ground for safety.

Copyright© 2004 EIZO NANA O CORPORATION All rights reserved. No part of this manual may be reproduced, stored in a retrieval system, or transmitted, in any form or by any means, electronic, mechanical, or otherwise, without the prior written permission of EIZO NANA O CORPORATION.

EIZO NANA O CORPORATION is under no obligation to hold any submitted material or information confidential unless prior arrangements are made pursuant to EIZO NANA O CORPORATION's receipt of said information. Although every effort has been made to ensure that this manual provides up-to-date information, please note that EIZO monitor specifications are subject to change without notice.

ENERGY STAR is a U.S. registered mark.

Apple and Macintosh are registered trademarks of Apple Computer, Inc.

VGA is a registered trademark of International Business Machines Corporation.

DPMS is a trademark and VESA is a registered trademark of Video Electronics Standards Association.

Windows is a registered trademark of Microsoft Corporation.

PowerManager is a trademark of EIZO NANA O CORPORATION.

ScreenManager, FlexScan and EIZO are registered trademarks of EIZO NANA O CORPORATION in Japan and other countries.



As an ENERGY STAR® Partner, EIZO NANA O CORPORATION has determined that this product meets the ENERGY STAR guidelines for energy efficiency.

TABLE OF CONTENTS

PRECAUTIONS	4
1. INTRODUCTION	9
1-1. Features	9
1-2. Package Contents	9
1-3. Controls & Connectors	10
2. CABLE CONNECTION	12
2-1. Before Connecting	12
2-2. Connecting the Signal Cable	13
2-3. Connecting Two PCs to the Monitor	15
3. SCREENMANAGER	16
3-1. How to use the ScreenManager	16
3-2. ScreenManager Adjustments and Settings.	17
3-3. FineContrast	18
3-4. Useful Functions	19
4. ADJUSTMENT	21
4-1. Screen Adjustment	21
4-2. Color Adjustment	25
4-3. Power-save Setup	27
5. ATTACHING AN ARM STAND	29
6. TROUBLESHOOTING	30
7. CLEANING	33
8. SPECIFICATIONS	34
9. GLOSSARY	38

PRECAUTIONS

IMPORTANT!

- This product has been adjusted specifically for use in the region to which it was originally shipped. If operated outside the region to which it was originally shipped, the product may not perform as stated in the specifications.
- To ensure personal safety and proper maintenance, please read this section and the caution statements on the unit (refer to the figure below).

[Location of the Caution Statements]

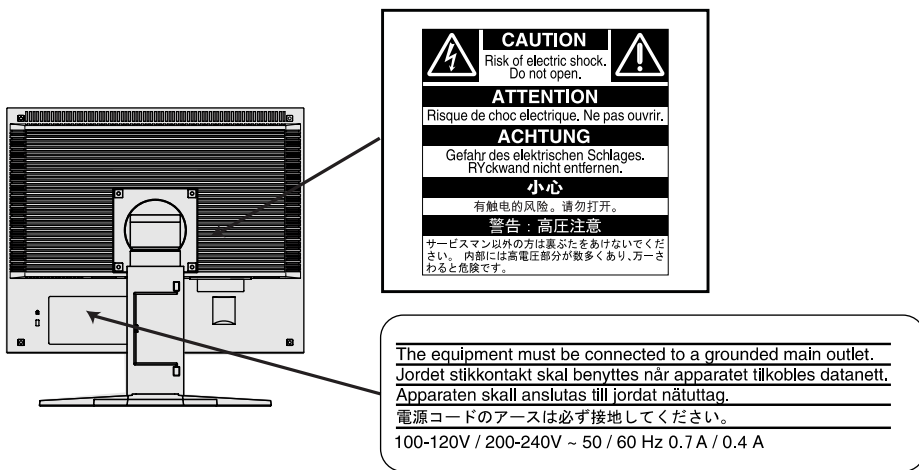

WARNING

If the unit begins to emit smoke, smells like something is burning, or makes strange noises, disconnect all power connections immediately and contact your dealer for advice.

Attempting to use a malfunctioning unit may result in fire, electric shock, or equipment damage.

Do not open the cabinet or modify the unit.

Opening the cabinet or modifying the unit may result in fire, electric shock, or burn.



Refer all servicing to qualified service personnel.

Do not attempt to service this product yourself as opening or removing covers may result in fire, electric shock, or equipment damage.

WARNING

Keep small objects or liquids away from the unit.

Small objects accidentally falling through the ventilation slots into the cabinet or spillage into the cabinet may result in fire, electric shock, or equipment damage. If an object or liquid falls/spills into the cabinet, unplug the unit immediately. Have the unit checked by a qualified service engineer before using it again.

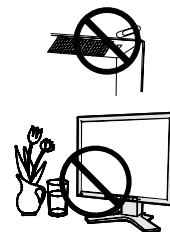

Place the unit at the strong and stable place.

A unit placed on an inadequate surface may fall and result in injury or equipment damage. If the unit falls, disconnect the power immediately and ask your dealer for advice. Do not continue using a damaged unit. Using a damaged unit may result in fire or electric shock.



Set the unit in an appropriate location.

Not doing so may result in fire, electric shock, or equipment damage.

- Do not place outdoors.
- Do not place in the transportation system (ship, aircraft, trains, automobiles, etc.)
- Do not place in a dusty or humid environment.
- Do not place in a location where the steam comes directly on the screen.
- Do not place near heat generating devices or a humidifier.

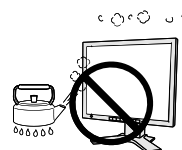

To avoid danger of suffocation, keep the plastic packing bags away from babies and children.

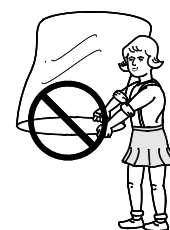

Use the enclosed power cord and connect to the standard power outlet of your country.

Be sure to remain within the rated voltage of the power cord. Not doing so may result in fire or electric shock.

To disconnect the power cord, grasp the plug firmly and pull.

Tugging on the cord may damage and result in fire or electric shock.



 **WARNING**

The equipment must be connected to a grounded main outlet.

Not doing so may cause in fire or electric shock.



Use the correct voltage.

- The unit is designed for use with a specific voltage only. Connection to another voltage than specified in this User's Manual may cause fire, electric shock, or equipment damage.
 - Do not overload your power circuit, as this may result in fire or electric shock.
-

Handle the power cord with care.

- Do not place the cord underneath the unit or other heavy objects.
- Do not pull on or tie the cord.

If the power cord becomes damaged, stop using it. Use of a damaged cord may result in fire or electric shock.



Never touch the plug and power cord if it begins to thunder.

Touching them may result in electric shock.



When attaching an arm stand, please refer to the user's manual of the arm stand and install the unit securely with the enclosed screws.

Not doing so may cause the unit to come unattached, which may result in injury or equipment damage. When the unit is dropped, please ask your dealer for advice. Do not continue using a damaged unit. Using a damaged unit may result in fire or electric shock. When reattaching the tilt stand, please use the same screws and tighten them securely.

Do not touch a damaged LCD panel directly with bare hands.

The liquid crystal which leaks from the panel is poisonous if it enters the eyes or mouth. If any part of the skin or body comes in direct contact with the panel, please wash thoroughly. If some physical symptoms result, please consult your doctor.



Follow local regulation or laws for safe disposal.

The backlight of the LCD panel contains mercury.

 **CAUTION**

Handle with care when carrying the unit.

Disconnect the power cord and cables when moving the unit. Moving the unit with the cord attached is dangerous. It may result in injury.

When handling the unit, grip the bottom of the unit firmly with both hands ensuring the panel faces outward before lifting.

Dropping the unit may result in injury or equipment damage.

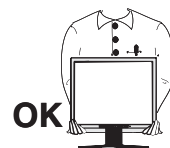
**Do not block the ventilation slots on the cabinet.**

- Do not place any objects on the ventilation slots.
- Do not install the unit in a closed space.
- Do not use the unit laid down or upside down.

Blocking the ventilation slots prevents proper airflow and may result in fire, electric shock, or equipment damage.

**Do not touch the plug with wet hands.**

Doing so may result in electrical shock.

**Use an easily accessible power outlet.**

This will ensure that you can disconnect the power quickly in case of a problem.

Periodically clean the area around the plug.

Dust, water, or oil on the plug may result in fire.

Unplug the unit before cleaning it.

Cleaning the unit while it is plugged into a power outlet may result in electric shock.

If you plan to leave the unit unused for an extended period, disconnect the power cord from the wall socket after turning off the power switch for the safety and the power conservation.

LCD Panel

When the monitor is cold and brought into a room or the room temperature goes up quickly, dew condensation may occur inside and outside the monitor. In that case, do not turn the monitor on and wait until dew condensation disappears, otherwise it may cause some damages to it.

In order to suppress the luminosity change by long-term use and to maintain the stable luminosity, use of a monitor in lower brightness is recommended.

The screen may have defective pixels. These pixels may appear as slightly light or dark area on the screen. This is due to the characteristics of the panel itself, and not the product.

The backlight of the LCD panel has a fixed life span. When the screen becomes dark or begins to flicker, please contact your dealer.

Do not press on the panel or edge of the frame strongly, as this may result in damage to the screen. There will be prints left on the screen if the pressed image is dark or black. If pressure is repeatedly applied to the screen, it may deteriorate or damage your LCD panel. Leave the screen white to decrease the prints.

Do not scratch or press on the panel with any sharp objects, such as a pencil or pen as this may result in damage to the panel. Do not attempt to brush with tissues as this may scratch the LCD panel.

When the screen image is changed after displaying the same image for extended periods of time, an afterimage may appear. Use the screen saver or timer to avoid displaying the same image for extended periods of time.

1. INTRODUCTION

Thank you very much for choosing an EIZO Color Monitor.

1-1. Features

- Dual inputs compliant
- DVI Digital input (TMDS) compliant
- [Horizontal scanning frequency] Analog: 24.8 - 80 kHz
Digital: 31 - 64 kHz
- [Vertical scanning frequency] Analog: 50 - 75 Hz
Digital: 59 - 61 Hz (VGA text: 69 - 71 Hz)
- [Resolution] 1280 dots x 1024 lines
- Auto Adjustment compliant
- FineContrast modes, to select the most suitable mode for screen display
- The EIZO LCD Utility Disk enclosed (See readme.txt in the CD-ROM for details.)
 - The utility software “ScreenManager Pro for LCD” (for Windows) to control a monitor from a PC with a mouse and a keyboard
 - The software “DesktopViewer” (for Windows) to display bright and clear still images
- The height adjustable stand incorporated
- Support to sRGB standard

1-2. Package Contents

Please contact your local dealer for assistance if any of the listed items are missing or damaged.

- | | |
|--------------------------------|---|
| ● LCD Monitor | ● User’s Manual (in the CD-ROM) |
| ● Power Cord | ● Setup Guide |
| ● Signal Cable (MD-C87) | ● ScreenManager Quick Reference |
| ● Signal Cable (FD-C35/FD-C39) | ● LIMITED WARRANTY |
| ● EIZO USB Cable (MD-C93) | ● Mounting Screws: M4 x 12 (mm) x 4 pcs |
| ● EIZO LCD Utility Disk | |

NOTE

- Please retain the packing materials for future transference.
- The EIZO USB cable is used when using the software in the EIZO Utility Disk. For information on the software, refer to the readme.txt in the EIZO LCD Utility Disk.

1-3. Controls & Connectors

Front (L568 is given as an example)

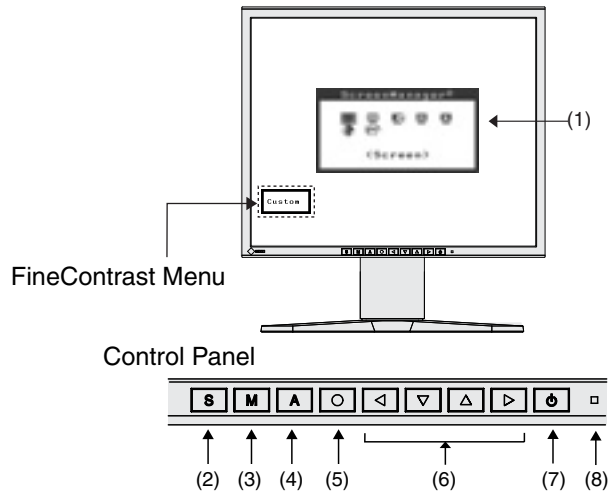

- (1) ScreenManager®
- (2) Input Signal Selection Button
- (3) Mode Button*1
- (4) Auto Adjustment Button
- (5) Enter Button
- (6) Control Buttons (Left, Down, Up, Right)
- (7) Power Button
- (8) Power Indicator*2

Blue	Operation
Yellow	Power saving
Flashing yellow (2 times for each)	Power save mode Digital only
Off	Power off

*1 Directly pressing the Mode button allows you to select a FineContrast mode. (The main menu of ScreenManager and the FineContrast menu cannot be displayed at the same time.)

*2 Regarding the power indicator for the “Off Timer”.

Rear (L568 is given as an example)

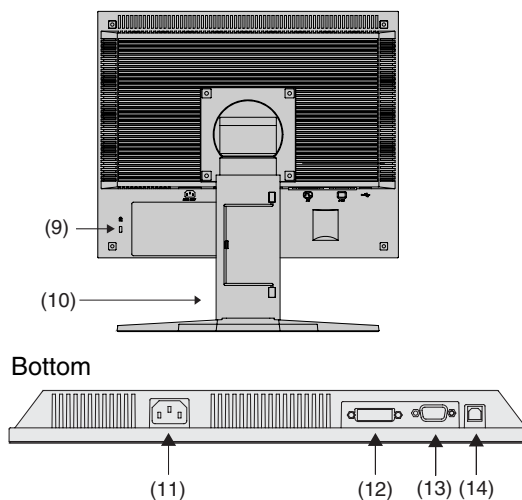

- (9) Security Lock Slot*³
- (10) Stand (Detachable)*⁴
- (11) Power Connector
- (12) DVI-D Input Connector
- (13) D-Sub mini 15 pin Input Connector
- (14) USB Port (1 Upstream)*⁵

*³ Allows for connection of a security cable. This lock supports Kensington's MicroSaver security system. For further information, please consult:
 Kensington Technology Group
 2855 Campus Drive, San Mateo, CA 94403 USA
 Tel.: 800-650-4242, x3348, Intl: 650-572-2700, x3348
 Fax: 650-572-9675
<http://www.kensington.com>

*⁴ The LCD monitor can be used with an optional arm stand by removing the stand (see "5. ATTACHING AN ARM STAND").

*⁵ USB Port upstream is used when using the software EIZO LCD Utility Disk (p. 15).

2. CABLE CONNECTION

2-1. Before Connecting

Before connecting your monitor to the PC, change the display screen settings (resolution and frequency) in accordance with the charts below.

NOTE

- The lower display modes like 640x 480, automatically enlarge to the maximum display mode (1280 x 1024), and some lines of the characters may become fuzzy. In this case, use <Smoothing> (p. 24) function to make the lines clear.
- When your computer and display support VESA DDC, the suitable resolution and the refresh rate are set by just plugging your display into the computer without any manual settings.

Analog Input

Resolution	Frequency	Dot Clock	Remarks
320 × 200	70 Hz	135 MHz (Max.)	VGA Graphic
640 × 480	~ 75 Hz		VGA, VESA
640 × 480	67 Hz		Apple Macintosh
720 × 400	70 Hz		VGA TEXT
800 × 600	~ 75 Hz		VESA
832 × 624	75 Hz		Apple Macintosh
1024 × 768	~ 75 Hz		VESA
1152 × 864	75 Hz		VESA
1152 × 870	75 Hz		Apple Macintosh
1280 × 960	60 Hz		VESA
1280 × 960	75 Hz		Apple Macintosh
1280 × 1024	~ 75 Hz		VESA

Digital Input

The monitor supports the following resolutions only.

Resolution	Frequency	Dot Clock	Remarks
640 × 480	60Hz	108 MHz (Max.)	VGA
720 × 400	70Hz		VGA TEXT
720 × 480	60Hz		VESA Safe Mode
800 × 600	60Hz		VESA
1024 × 768	60Hz		VESA
1280 × 1024	60Hz		VESA

2-2. Connecting the Signal Cable

NOTE

- Be sure that the power switches of both the PC and the monitor are OFF.

1. **Plug the signal cable into the connector at the rear of the monitor and the other end of the cable into the video connector on the PC.**

After connecting, secure the connection with the screw-in fasteners.

Analog Input

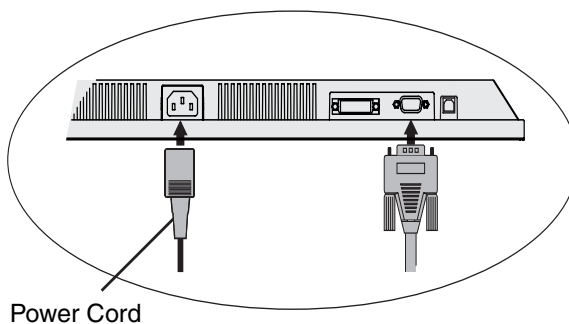

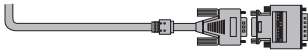
Signal Cable	Connector of the PC	PC
Signal Cable (enclosed) 	Video Output Connector / D-Sub mini 15 pin	<ul style="list-style-type: none"> ● Standard graphics card ● Power Macintosh G3 (Blue & White) / Power Mac G4 (VGA)
Signal Cable (enclosed) + Macintosh Adapter (Optional) 	Video Output Connector / D-Sub 15 pin	<ul style="list-style-type: none"> ● Macintosh

Digital Input

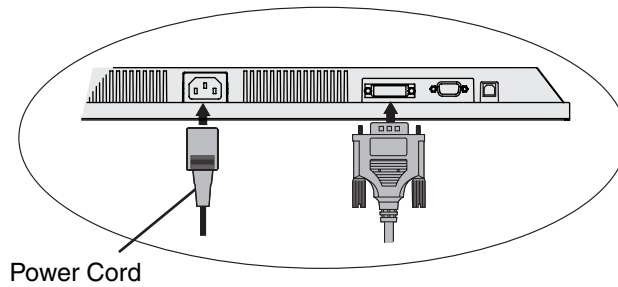

Signal Cable	Connector of the PC	PC
FD-C35 / FD-C39 (enclosed) 	Video Output Connector / DVI	<ul style="list-style-type: none"> Digital Graphics card Power Mac G4/G5 (DVI)

NOTE

- The monitor is not compatible with a Power Mac G4/G5 (Apple Display Connector).

- Plug the power cord into the power connector on the rear of the monitor. Then, plug the other end of the cord into a power outlet.



WARNING

Use the enclosed power cord and connect to the standard power outlet of your country.

Be sure to remain within the rated voltage of the power cord. Not doing so may result in fire or electric shock.

The equipment must be connected to a grounded main outlet.

Not doing so may result in fire or electric shock.



3. Adjust the “height”, “front and back position” and “angle” of the monitor (L568-AS only).

Grip both side of the center part of the monitor and move slowly (refer to the right figure.)

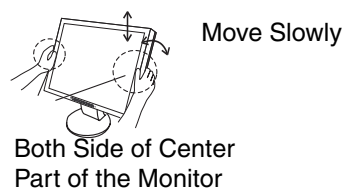

- (1) Adjust the height of the monitor. To heighten, push the monitor backward. To lower, pull the monitor forward.
- (2) Adjust the position and angle of the monitor.
- (3) If necessary, fine adjust the height of the monitor.

4. Turn on the monitor’s main power and then switch on the PC’s power.

The monitor’s power indicator will light up (blue). If an image does not appear, refer to the “6. TROUBLESHOOTING” for advice. Whenever finished, turn off the PC and the monitor.

5. When using the software in the EIZO LCD Utility Disk: Connect the upstream port of the monitor to the downstream port of the USB compliant PC or another hub with the USB cable.

After connecting the USB cable, the USB function can be set up automatically. For further details about the software, refer to the readme.txt in the CD-ROM.

NOTE

- Adjust brightness of the screen depending on the brightness of your environment. Too dark or too bright of a screen can cause eyestrain.
- Be sure to take adequate rests. A 10-minute rest period each hour is suggested.

2-3. Connecting Two PCs to the Monitor

Two PCs can be connected to the monitor through the DVI and the D-Sub mini 15 pin connector on the back of the monitor.

Selecting the Active Input

The Input signal selection button on the control panel can be used to select either DVI or D-Sub as the active input at any time. Every time the button is pressed, the input changes. When switching the signal, the kind of the input signal (Analog or Digital) is displayed for a few seconds on the right top corner of the screen.



3. SCREENMANAGER

3-1. How to use the ScreenManager

ScreenManager allows you to adjust screen performance through the main menu and select a FineContrast mode easily.

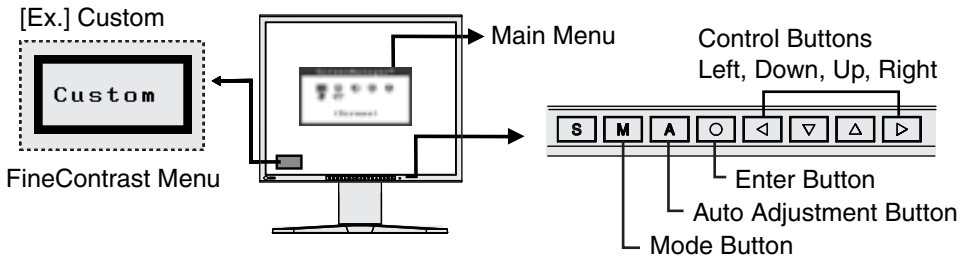

NOTE

- Main Menu and FineContrast Menu cannot be activated at the same time.

1. Entering the ScreenManager

Press the Enter Button once to display the main menu of the ScreenManager.

2. Making Adjustments and Settings

- (1) Select the desired sub menu icon using the Control buttons and presspress the Enter button. The sub menu appears.
- (2) Use the Control buttons to select the desired setting icon and press the Enter button. The setting menu appears.
- (3) Use the Control buttons to make all required adjustments and press the Enter button to save the settings.

3. Exiting the ScreenManager

- (1) To return to the main menu, select the <Return> icon or press the Down button twice, followed by the Enter button.
- (2) To exit the ScreenManager, select <Exit> icon or press the Down button twice, followed by the Enter button.

NOTE

- Double clicking the Enter button also exits the ScreenManager menu.

FineContrast Menu

Directly pressing the Mode button allows you to select the best suited mode for screen display from 5 FineContrast modes; Custom, sRGB, Text, Picture and Movie. To exit the menu, press the Enter button.

3-2. ScreenManager Adjustments and Settings.

The following table shows all the ScreenManager's adjustment and setting menus. “**” indicates adjustments of analog input only and “***” indicates digital input only.

Main menu	Sub menu		Reference
Screen	Clock	*	4-1. Screen Adjustment
	Phase	*	
	Position	*	
	Range Adjustment	*	
	Smoothing		
Color (Custom)*1	Brightness		4-2. Color Adjustment
	Temperature		
	Gamma		
	Saturation		
	Hue		
	Gain		
	Reset		
Power Manager	DVI DMPM	**	4-3. Power-save Setup
	VESA DPMS	*	
Others	Input Signal		Set the input signal selection of automatic or manual (p. 20).
	Off Timer		Set the monitor's off timer.
	VGA Selection	*	Select the display mode (p. 31).
	Menu Position		Adjust the menu position
	Translucent		Set the transparency of the menu.
	Menu Off Timer		Set the menu displaying time.*2
	Reset		Return to the factory default settings.
Information	Information		Review the ScreenManager's settings, model name, serial number and usage time.*3
Language	English, German, French, Spanish, Italian, Swedish and Japanese		Select the ScreenManager's language.

*1 The adjustable functions on the <Color> menu depend on the selected FineContrast mode. The above table shows the sub menus when the “Custom” mode is selected (see “4-2. Color Adjustment”).

*2 The displaying time of the FineContrast Menu cannot be changed.

*3 Due to the inspection on the factory, the usage time may not “0 hour” at shipping.

3-3. FineContrast

This function allows you to select the best suited mode for screen display.

To select the Mode

Directly pressing the Mode button allows you to select the best suited mode for screen display from 5 FineContrast modes; Custom, sRGB, Text, Picture and Movie.

Exit

Press the Enter button to exit the menu. Leaving the Mode button untouched more than 5 seconds also exits the menu.

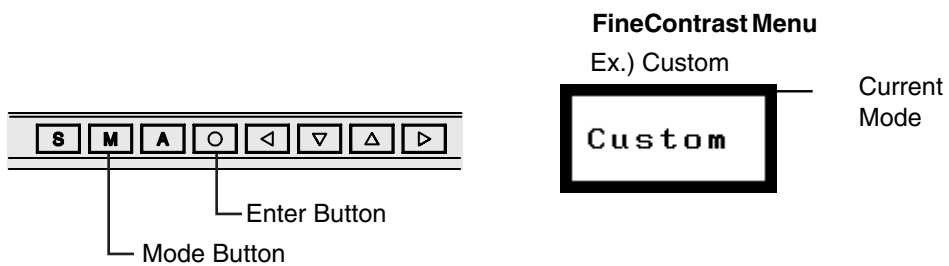

FineContrast Mode

Selectable FineContrast modes are as follows.

Custom	To adjust the color settings according to your preference
sRGB	To display the screen images based on those original colors (ex. over the Internet)
Text	Text on word processor or spreadsheet software
Picture	Photo or picture image
Movie	Animated images

Color Adjustment of the Mode Settings

The color settings of each mode can be adjusted by using the <Color> menu of the ScreenManager. (See “4-2. Color Adjustment”.)

3-4. Useful Functions

Adjustment Lock

Use the “Adjustment Lock” function to prevent any accidental changes.

Locked function	<ul style="list-style-type: none"> ● Settings in the ScreenManager ● Auto adjustment button adjustments
Unlocked function	<ul style="list-style-type: none"> ● Selecting of the FineContrast mode by the Mode button. ● Brightness adjustment by Control buttons ● Input signal selection button ● Turning the power on and off by the Power button

[How To lock]

- (1) Switch off the monitor’s power by the power button on the control panel.
- (2) Press on the Auto adjustment button while switching on the monitor’s power.

[How To unlock]

- (1) Switch off the monitor’s power by the power button on the control panel.
- (2) Hold down the Auto adjustment button once again and turn the power back on.

Off Timer

The off timer function causes the monitor to automatically enter a power off state after a predetermined amount of time has lapsed. This function was created to reduce afterimage characteristics that are particular to LCD monitors when the monitor screen is left on for a long period without use.

[Procedure]

- (1) Select <Off Timer> in the ScreenManager <Others> menu.
- (2) Select “Enable” and press the Right and Left buttons to adjust the “On Period” (1 to 23 hours).

[Off Timer System]

PC	Monitor	Power Indicator
On Period (1H - 23H)	Operation	Blue
Last 15 min. in “On period”	Advance Notice*1	Blue Flashing
“On period” expired	Power Off	Off

*1 Advance notice (Power Indicator flashing blue) will be given 15 minutes before the monitor automatically enters the “Power Off” mode. To delay entering the “Power Off” mode, press the power button during the advance notice period. The monitor will continue to operate for an additional 90 minutes.

[Power Resumption Procedure]

Press the Power button.

NOTE

- The off timer function works while the PowerManager is active, but there is no advance notice before the monitor's power is switched off.

EIZO Logo Disappearing Function

When switching on the power button on the front panel, the EIZO logo is displayed for a while. If you desire to display or undisplay this logo, use this function. (Default is logo appearing.)

[To undisplay]

Switch off the monitor's power by the power button, then hold down the Enter button once again and turn the power back on.

[To display]

Switch off the monitor's power by the power button, then hold down the Enter button once again and turn the power back on.

Automatically Selecting the Input Signal Function

The monitor will automatically detect the inputted signal of either the connection for display. (Default: this function is set ("Auto").)

NOTE

- **Connecting Two PCs to the Monitor**
When the one computer is switched off or entering the power saving mode, the monitor will automatically display the other signal.

Use the ScreenManager to switch the input signal manually.

[Procedure]

- (1) Select <Input Signal> in the <Others> menu.
- (2) Select <Manual>.

4. ADJUSTMENT

The monitor displays the digital input image correctly based on its pre-setting data.

4-1. Screen Adjustment

Screen adjustments for the LCD monitor should be used in suppressing screen flickering and also for adjusting the screen to its proper position. There is only one correct position for each display mode. It is also recommended to use the ScreenManager function when first installing the display or whenever changing the system. For convenience, an easy set-up Program installed on the utility disk to assist in the set-up procedure is provided.

NOTE

- Allow the LCD monitor to stabilize for at least 20 minutes before making image adjustments.

Adjustment Procedure

1. Press the Auto adjustment button on the front panel.

The message “Your setting will be lost, if you press again now.” appears and remains on the screen for 5 seconds. While the message is on the screen, press the Auto adjustment button again to automatically adjust the clock, phase, screen position and resolution. If you do not wish to do adjust the screen, do not press the Auto adjustment button again.

NOTE

- The Auto sizing function is intended for use on the Macintosh and on AT-compatible PC running Windows. It may not work properly in either of the following cases. When running an AT-compatible PC on MS-DOS (Not windows). The background color for the “wall paper” or “desktop” pattern is set to black.

If the appropriate screen cannot be made by using the Auto adjustment button, adjust the screen through the following procedures. If the appropriate screen can be made, proceed to step 4.

2. Run the “Screen adjustment program”.

Having read the “Readme.txt” file, run the “Screen adjustment program” in the enclosed EIZO LCD Utility Disk. Step by step, adjustment is provided by the wizard guide. (If using the Windows, the program can be directly run from the menu screen of the CD-ROM.)

NOTE

- If the user’s operating system has no utility disk (e.g. OS/2), we recommend setting the desktop pattern to that as shown in the diagram on the following.

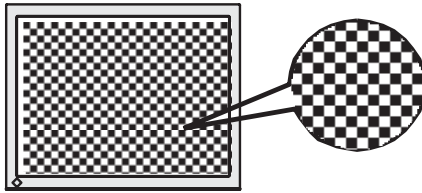



3. Adjust by using <Screen> menu in the ScreenManager.

- (1) Vertical bars appear on the screen
→  Use the <Clock> adjustment.

Select the <Clock> and eliminate the vertical bars by using the Right and Left of the Control buttons.

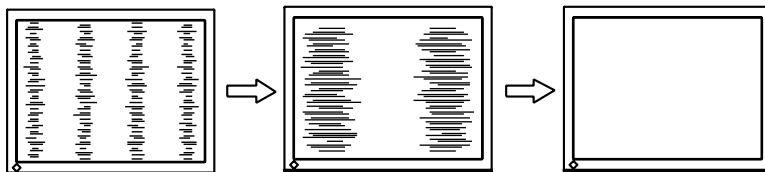
Do not continuously press the Control buttons, as the adjustment value will change quickly and make it difficult to locate the most suitable adjustment point. If the horizontal flickering, blur or bars appear, proceed to <Phase> adjustment as follows.



- (2) Horizontal bars appear on the screen.
→  Use the <Phase> adjustment.

Select the <Phase> and eliminate the horizontal flickering, blurring or bars by using the Right and Left buttons.

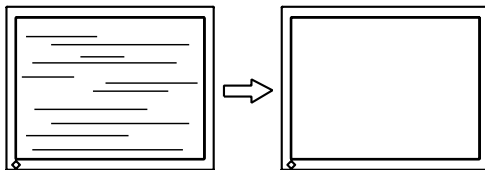

NOTE

- Horizontal bars may not completely disappear from the screen depending on the PC.

- (3) The screen position is incorrect.
→  Use the <Position> adjustment.

The correct displayed position of the monitor is decided because the number and the position of the pixels are fixed. The <Position> adjustment moves the image to the correct position.

Select <Position> and adjust the position by using the Up, Down, Right and Left buttons.

If vertical bars of distortion appear after finishing the <Position> adjustment, return to <Clock> adjustment and repeat the previously explained adjustment procedure. Clock → Phase → Position.

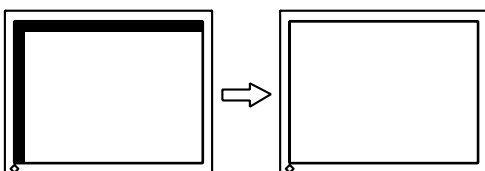

4. **Adjust the output signal range (Dynamic Range) of the signal.**
→  Use the <Range Adjustment> of <Screen> menu.

This controls the level of output signal range to display the whole color gradation (256 colors).

[Procedure]

Press the Auto adjustment button on the front panel while displaying the <Range Adjustment> menu to automatically adjust the range. The screen blanks for a moment and adjusts the color range to display the whole color gradation of the current output signal.

5. To smooth the blurred texts of the enlarged screen of the lower resolutions.

→  **Switch the <Smoothing> setting.**

Select the suitable level from 1 - 5 (Soft - Sharp).

Select <Smoothing> in the <Screen> menu and adjust by using the Right and Left buttons.

NOTE

- The <Smoothing> is disabled in the resolution 1280 x 1024.
- Since the displayed image is enlarged, the blurred texts may not be necessarily lost completely.

4-2. Color Adjustment







Color settings of each FineContrast mode can be adjusted and saved by using the <Color> menu of the ScreenManager.

In the analog input, perform the <Range Adjustment> (p. 23) before making the color adjustments.

Adjustment Items







The adjustable items and displayed icons on the <Color> menu depend on the selected FineContrast mode.

“√”: Settable/Adjustable “–”: Fixed at the factory

Icons	Functions	FineContrast Modes				
		Custom	sRGB	Text	Picture	Movie
	Brightness	√	√	√	√	√
	Temperature	√	–	√	√	√
	Gamma	√	–	√	–	–
	Saturation	√	–	√	√	√
	Hue	√	–	√	√	√
	Gain	√	–	–	–	–
	Reset	√	–	√	√	√

NOTE

- Allow the LCD monitor to stabilize for at least 20 minutes before making image adjustments.
- Performing the <Reset> of the <Color> menu returns the color settings of the selected mode to the default settings.

Menu	Function Descriptions	Adjustable range
Brightness 	To set the brightness of the screen	0 ~ 100 %
Temperature 	To set the color temperature	4,000 ~ 10,000 K in 500 K increments (including 9,300 K). Default setting is off (normal white)
	NOTE <ul style="list-style-type: none"> ● The values shown in the Kelvin are available only as a reference tool. ● Setting the temperature under 4,000 K or over 10,000 K invalidates the color temperature setting. (The color temperature's setting turns "OFF".) 	
Gamma 	To set the gamma value	1.8 ~ 2.6 (in 0.2 increments)
	NOTE <ul style="list-style-type: none"> ● If setting the gamma value, the using the monitor in the digital signal input is recommended. 	
Saturation 	To change the saturation	-128 ~ 127 Setting the minimum level (-128) turns the image to the monochrome.
	NOTE <ul style="list-style-type: none"> ● The <Saturation> adjustment may cause undisplayable color tone. 	
Hue 	To change the flesh color, etc.	-32 ~ 32
	NOTE <ul style="list-style-type: none"> ● The <Hue> adjustment may cause undisplayable color tone. 	
Gain 	To change each color (red, green and blue)	0 ~ 100% By adjusting the red, green and blue color tones for each mode, custom colors can be defined. Display a white or gray background image and adjust the <Gain>.
	NOTE <ul style="list-style-type: none"> ● The values shown in the percentage are available only as a reference tool. ● Setting the <Temperature> invalidates the <Gain> adjustment. <Gain> setting returns to the default. 	
Reset 	To return the color settings of the selected mode to the default settings	Select the <Reset>.

4-3. Power-save Setup

The <PowerManager> menu in the ScreenManager enables to set the power-save setup.

NOTE

- Do your part to conserve energy, turn off the monitor when you are finished using it. Disconnecting the monitor from the power supply is recommended to save energy completely.

Analog Input

This monitor complies with the “VESA DPMS”.

[Procedure]

- (1) Set the PC’s power saving settings.
- (2) Select “VESA DPMS” from the <PowerManager> menu.

[Operation]

PC		Monitor	Power Indicator
Operation		Operation	Blue
Power saving	STAND-BY SUSPEND OFF	Power saving	Yellow

[Power Resumption Procedure]

Operate the mouse or keyboard to return to a normal screen.

Digital Input

This monitor complies with the “DVI DMPM”.

[Procedure]

- (1) Set the PC’s power saving settings.
- (2) Select “DVI DMPM” from the <PowerManager> menu.

[Power Saving System]

PC		Monitor	Power Indicator
Operation		Operation	Blue
Power saving		Power saving	Yellow
Off mode		Power saving*1	Flashing yellow (2 times for each)

*1 Power saving through the PC's off mode is only supported when "Manual" is selected on the ScreenManager's <Input Signal>.

[Power Resumption Procedure]

Operate the mouse or keyboard to return to a normal screen from the Power save mode of the PC.

Power on the PC to return a normal screen from the Off mode of the PC.

5. ATTACHING AN ARM STAND

The LCD monitor can be used with an arm stand by removing the tilt stand and attaching the arm stand to the LCD monitor. Using our optional arm or stand is recommended. (Ask your local dealer for information.)

NOTE

- If you will use the arm or stand of other companies, confirm the followings to the arm or stand maker before selecting.
 - Hole spacing on the arm mounting: 100 mm x 100 mm (VESA compliant)
 - Supportable Weight: Total weight of the monitor (without stand) and attaching equipment such as a cable
 - TÜV/GS approved arm or stand
- Please connect cables after attaching an arm stand.

Setup Procedure

1. Lay the LCD monitor down. Do not scratch the panel.
2. Remove the tilt stand by loosening the screws (4 pcs of M4 x 14 mm).
3. Attach an arm stand to the LCD monitor securely.

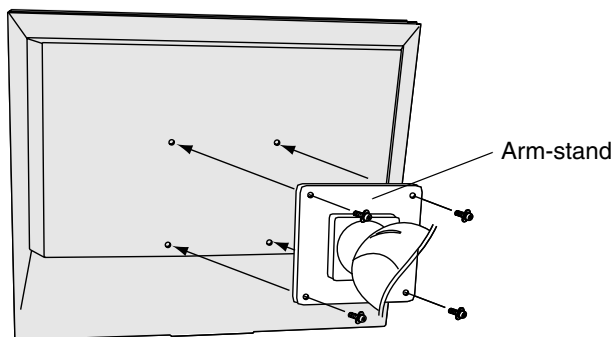



4 Mounting Screws : M4 x 12 mm (Enclosed)

6. TROUBLESHOOTING

If a problem persists even after applying the suggested remedies, contact an EIZO dealer.

- No picture problems → See No.1 ~ No.2
- Imaging problems → See No.3 ~ No.11
- Other problems → See No.12 ~ No.14

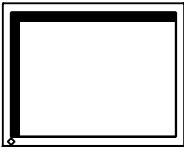
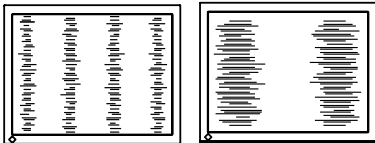
Problems	Points to check with Possible Solutions
<p>1. No picture</p> <ul style="list-style-type: none"> ● Indicator status: Off ● Indicator status: Blue ● Indicator status: Yellow ● Indicator status: Flashing Yellow (twice for each) 	<ul style="list-style-type: none"> <input type="checkbox"/> Check that the power cord is correctly connected. If the problem persists, turn off the monitor power for a few minutes, then turn it back on and try again. <input type="checkbox"/> Check the “Brightness” setting. <input type="checkbox"/> Switch the signal input by pressing the Input Signal Selection Button on the front control panel. <input type="checkbox"/> Try pressing a key on the keyboard, or clicking the mouse. <input type="checkbox"/> Try pressing the power of the computer (p. 28).
<p>2. Following messages appear. (Error messages shown below will remain on the screen for 40 seconds.)</p> <div style="border: 2px solid black; padding: 5px; text-align: center; margin: 10px 0;"> <p>Signal Check</p> <p>Anal og</p> <p>No Signal</p> </div> <ul style="list-style-type: none"> ● Whenever an error signal message appears, the signal frequency will be displayed in red. (Example) <div style="border: 2px solid black; padding: 5px; text-align: center; margin: 10px 0;"> <p>Signal Error</p> <p>Digital</p> <p>fD: 135.0MHz</p> <p>fH: 80.0kHz</p> <p>fV: 75.0Hz</p> </div>	<p>These messages appear when the signal is not inputted correctly, even if the monitor functions properly.</p> <ul style="list-style-type: none"> <input type="checkbox"/> When the image is displayed correctly after a short time, there is no problem with the monitor. (Some PCs do not output the signal soon after powering on.) <input type="checkbox"/> Check that the signal cable is properly connected to the PC or graphics board. <input type="checkbox"/> Switch the signal input by pressing the Input signal selection button on the front control panel. <input type="checkbox"/> Use the graphics board's utility software to change the frequency setting. (Refer to the manual of the graphics board.)

Problems	Points to check with Possible Solutions
<p>3. Display position is incorrect.</p> 	<ul style="list-style-type: none"> <input type="checkbox"/> Adjust the image position using the <Position> (p. 23). <input type="checkbox"/> The two display modes, VGA 720 x 400 (70 Hz) and 320 x 200 (70 Hz), have the same signal timings. Using <VGA Selection> selects the appropriate display mode. (This function effects only when the resolution is VGA 720 x 400 (70 Hz) or 320 x 200 (70 Hz). <input type="checkbox"/> If the problem persists, use the graphics board's utility software to change the display position if available.
<p>4. Vertical bars of distortion appear.</p> 	<ul style="list-style-type: none"> <input type="checkbox"/> Decrease the vertical bars using the <Clock> (p. 22).
<p>5. Horizontal bars of distortion appear.</p> 	<ul style="list-style-type: none"> <input type="checkbox"/> Decrease the horizontal bars using the <Phase> (p. 23).
<p>6. Letters and lines appear blurred.</p>	<ul style="list-style-type: none"> <input type="checkbox"/> Switch the <Smoothing> (p. 24) mode to "Off".
<p>7. The screen is too bright or too dark.</p>	<ul style="list-style-type: none"> <input type="checkbox"/> Adjust the <Brightness> (The backlight of the LCD monitor has a fixed life span. When the screen becomes dark or begins to flicker, please contact your dealer.)
<p>8. Afterimages appear.</p>	<ul style="list-style-type: none"> <input type="checkbox"/> Do you use the screen saver or timer when displaying the same image for extended periods of time? <input type="checkbox"/> Afterimages are particular to LCD monitors. Avoid displaying the same image for extended periods of time.
<p>9. The screen has defective pixels (e.g. slightly light or dark).</p>	<ul style="list-style-type: none"> <input type="checkbox"/> This is due to the characteristics of the panel itself, and not the LCD product.
<p>10. Fingerprints remain on the screen.</p>	<ul style="list-style-type: none"> <input type="checkbox"/> Leaving the screen white may solve the problem.
<p>11. The <Smoothing> cannot be selected.</p>	<ul style="list-style-type: none"> <input type="checkbox"/> <Smoothing> is disabled when the screen is displayed in the 1280 x 1024.

Problems	Points to check with Possible Solutions
12. The ScreenManager cannot be activated.	<input type="checkbox"/> The adjustment lock is probably on. To unlock (p. 19): switch the LCD monitor off. Then, while pressing the Auto adjustment button switch, the power on.
13. The Auto Adjustment Button does not operate.	<input type="checkbox"/> The Auto adjustment button does not operate when the digital signal is inputted <input type="checkbox"/> The adjustment lock is probably on. To unlock (p. 19): switch the monitor off. Then, while pressing the Auto adjustment button, switch the monitor on.
14. The Input signal selection button does not operate.	<input type="checkbox"/> The computer with digital may be in the off mode (power indicator flashing yellow). Try to press the monitor's power button and press the Input signal selection button again.

7. CLEANING

Periodic cleaning is recommended to keep the monitor looking new and to prolong its operation lifetime.

NOTE

- Never use thinner, benzene, alcohol (ethanol, methanol, or isopropyl alcohol), abrasive cleaners, or other strong solvents, as these may cause damage to the cabinet or LCD panel.

Cabinet

To remove stains, wipe the cabinet with a soft, lightly moistened cloth using a mild detergent. Do not spray wax or cleaner directly into the cabinet. (For details, refer to the manual of the PC.)

LCD Panel

- The LCD surface can be cleaned with a soft cloth, such as cotton or lens paper.
- If necessary, stubborn stains can be removed by moistening part of a cloth with water to enhance its cleaning power.

8. SPECIFICATIONS

LCD Panel	43 cm (17.0 inch), TFT color LCD panel with Anti-Glare Hard Coating, Viewing Angle: H: 178°, V: 178° (CR ≥ 10)
Dot Pitch	0.264 mm
Horizontal Scan Frequency	Analog: 24.8 ~ 80 kHz (Automatic) Digital: 31 ~ 64 kHz
Vertical Scan Frequency	Analog: 50 ~ 75 Hz (Automatic) Digital: 59 ~ 61 Hz (VGA Text: 69 ~ 71 Hz)
Resolution	1280 dots x 1024 lines
Dot Clock (Max.)	Analog: 135 MHz, Digital: 108 MHz
Display Colors	16 million colors (max)
Display Area	337 mm (H) x 270 mm (V) (13.3" (H) x 9.1" (V)) (Viewable image size: 430 mm (17.0"))
Power Supply	100 - 120 VAC ±10%, 50/60 Hz, 0.7 A 200 - 240 VAC ±0%, 50 Hz, 0.4 A
Power Consumption	Max.: 40 W Power Saving Mode: Less than 2 W (for single signal input)
Input Connector	D-Sub mini 15 pin, DVI-D
Analog Input Signal (Sync)	Separate, TTL, Positive/Negative
Analog Input Signal (Video)	0.7 Vp-p / 75 Ω Positive
Input Signal (Digital)	TMDS (Single Link)
Signal registration	Analog: 45 (Factory preset: 20)
Plug & Play	VESA DDC 2B
Dimensions	
L568	362 mm (W) x 389 ~ 489 mm (H) x 205 mm (D) (14.3" (W) x 15.3" ~ 19.3" (H) x 8.1" (D))
L568-AS	362 mm (W) x 280 ~ 406 mm (H) x 200 mm (D) (14.3" (W) x 11" ~ 16" (H) x 7.9" (D))
Dimensions (without stand)	362 mm (W) x 299 mm (H) x 55 mm (D) (14.3" (W) x 11.8" (H) x 2.17" (D))
Weight	
L568	5.8 kg (12.8 lbs.)
L568-AS	5.6 kg (12.3 lbs.)
Weight (without stand)	3.7 kg (8.2 lbs.)
Temperature	Operating: 0°C ~ 35°C (32°F ~ 95°F) Storage: -20°C ~ 60°C (-4°F ~ 140°F) Humidity 30% to 80% R.H. Non-condensing

Certifications and Standards	
100-120 VAC	TCO'03*1, TCO'99*2, NRTL/C-TÜV, FCC-B, EPA ENERGY STAR Program, TÜV/Rheinland Ergonomics Approved
200-240 VAC	TCO'03*1, TCO'99*2, CE, CB, TÜV Rheinland/GS, EPA ENERGY STAR Program, TÜV/Rheinland Ergonomics Approved

*1 Applicable to gray color version only.

*2 Applicable to black color version only.

■ Default settings

	Analog input	Digital input
Brightness	100%	100%
Smoothing	3	
FineContrast Mode	Custom	
PowerManager	VESA DPMS	DVI DMPM
Input Signal	Auto	
Off Timer	Disable	
Language	English	

■ Dimensions

mm (inches)

<L568>

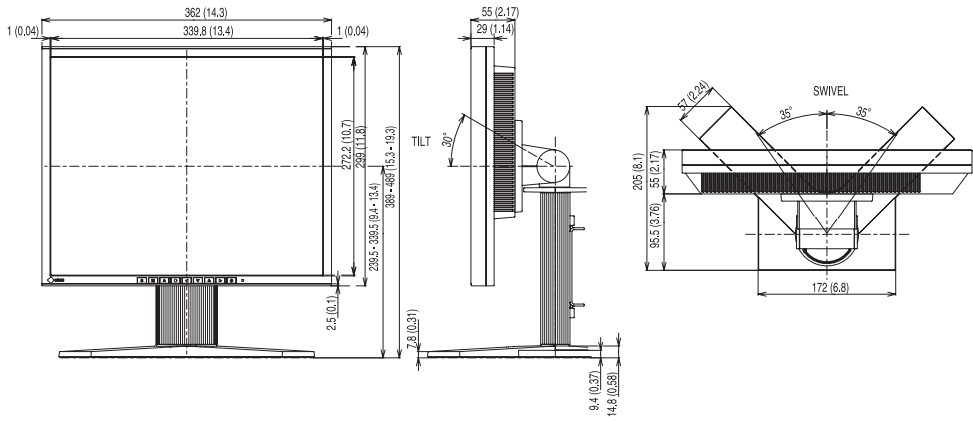

<L568-AS>

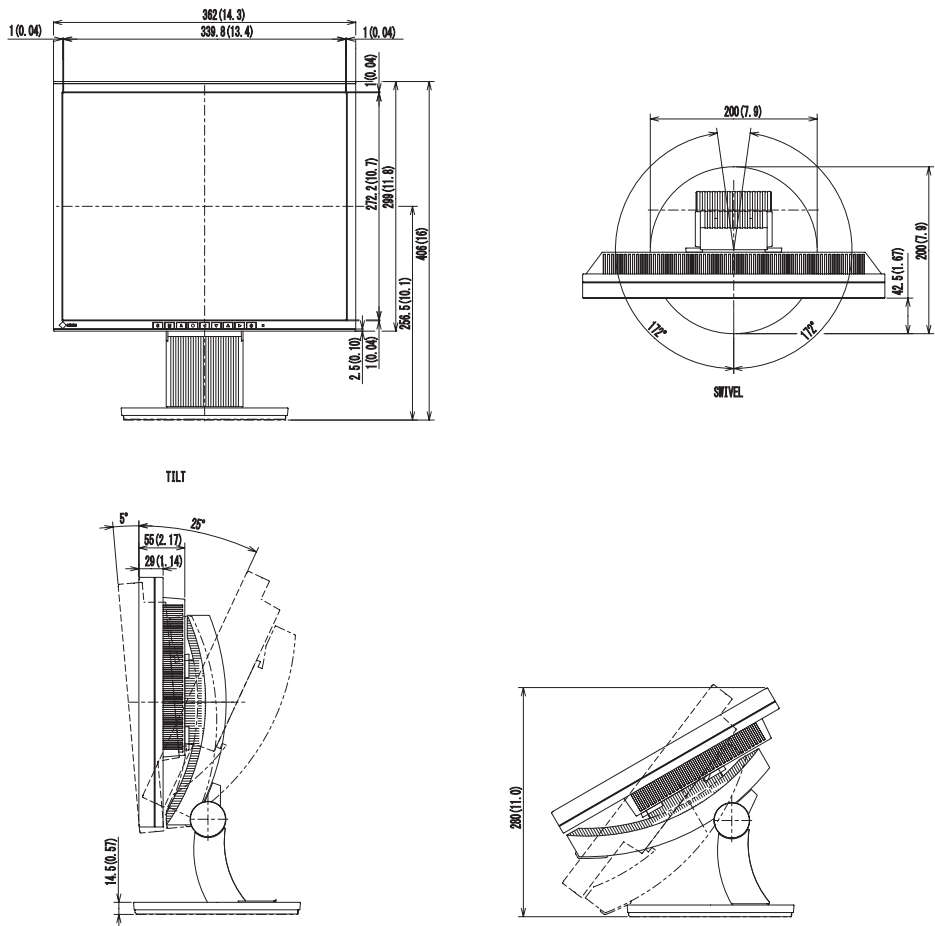

■ Pin Assignment

D-Sub mini 15 pin connector

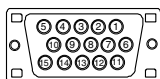

Pin No.	Signal	Pin No.	Signal	Pin No.	Signal
1	Red video	6	Red ground	11	Ground Shorted
2	Green video	7	Green ground	12	Data (SDA)
3	Blue video	8	Blue ground	13	H. Sync
4	Ground	9	No pin	14	V. Sync
5	No pin	10	Ground Shorted	15	Clock (SCL)

DVI-D Connector

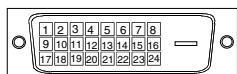

Pin No.	Signal	Pin No.	Signal	Pin No.	Signal
1	TMDS Data 2-	9	TMDS Data 1-	17	TMDS Data 0-
2	TMDS Data 2+	10	TMDS Data 1+	18	TMDS Data 0+
3	TMDS Data 2/4 Shield	11	TMDS Data 1/3 Shield	19	TMDS Data 0/5 Shield
4	NC*	12	NC*	20	NC*
5	NC*	13	NC*	21	NC*
6	DDC Clock (SCL)	14	+5V Power	22	TMDS Clock shield
7	DDC Data (SDA)	15	Ground (For +5V)	23	TMDS Clock+
8	NC	16	Hot Plug Detect	24	TMDS Clock-

(*NC: No Connection)

9. GLOSSARY

Clock

With the analog input signal display, the analog signal is converted to a digital signal by the LCD circuitry. To convert the signal correctly, the LCD monitor needs to produce the same number clock pulse as the dot clock of the graphics system. When the clock pulse is not correctly set, some vertical bars of distortion are displayed on the screen.

DVI

(Digital Visual Interface)

A digital flat panel interface. DVI can transmit digital data from the PC directly without loss with the signal transition method “TMDS”. There are two kinds of DVI connectors. One is DVI-D connector for digital signal input only. The other is DVI-I connector for both digital and analog signal inputs.

DVI DMPM

(DVI Digital Monitor Power Management)

The Power management system for the digital interface. The “Monitor ON” status (operation mode) and the “Active Off” status (power-saving mode) are indispensable for the DVI-DMPM as the monitor’s power mode.

Gain Adjustment

Adjusts each color parameter for red, green and blue. The color of the LCD monitor is displayed through the color filter of the LCD panel. Red, green and blue are the three primary colors. The colors on the monitor are displayed by combining these three colors. The color tone can change by adjusting the illumination amount passed through each color’s filter.

Gamma

Generally, the relationship that the light intensity values of a monitor change nonlinearly to the input signal level is called “Gamma Characteristic”. On the monitor, low gamma values display the whitish images and high gamma values display the high contrast images.

Phase

The phase adjustment decides the sampling timing point for converting the analog input signal to a digital signal. Adjusting the phase after the clock adjustment will produce a clear screen.

Range Adjustment

The Range Adjustment controls the level of output signal range to display the whole color gradation.

Resolution

The LCD panel consists of a fixed number of pixel elements which are illuminated to form the screen image. This products' display panel consists of 1280 horizontal pixels and 1024 vertical pixels. At a resolution of 1280 x 1024, all pixels are displayed as a full screen.

sRGB

(Standard RGB)

“International Standard for Red, Green, and Blue color space” A color space was defined with the aim of the color matching between applications and hardware devices, such as monitors, scanners, printers and digital cameras. As a standard default space, sRGB allows Internet users to closely match colors.

Temperature

Color Temperature is a method to measure the white color tone, generally indicated in degrees Kelvin. At high temperatures the white tone appears somewhat blue, while at lower temperatures it appears somewhat red. Computer monitors generally give best performance at high temperature settings.

5,000 K: Slightly reddish white.

6,500 K: Warm-white tone, similar to white paper or daylight.

9,300 K: Slightly bluish white.

TMDS

(Transition Minimized Differential Signaling)

A signal transition method for the digital interface.

VESA DPMS

(Video Electronics Standards Association - Display Power Management Signaling)

The acronym VESA stands for “Video Electronics Standards Association”, and DPMS stands for “Display Power Management Signaling”. DPMS is a communication standard that PCs and graphics boards use to implement power savings on the monitor side.

APPENDIX/ANHANG/ANNEXE

Preset Timing Chart for Analog input Timing-Übersichten für Analog Eingang Synchronisation des Signaux pour Analog numerique

Based on the signal diagram shown below 20 factory presets have been registered in the monitor's microprocessor.

Der integrierte Mikroprozessor des Monitors unterstützt 20 werkseitige Standardeinstellungen (siehe hierzu die nachfolgenden Diagramme).

25 signaux ont été enregistrés en usine dans le microprocesseur du moniteur, conformément au diagramme de synchronisation ci-dessous.

Mode	Dot Clock MHz	Sync Polarity		Frequencies	
		H	V	fH: kHz	fV: Hz
VGA Graphic 320 × 200	25.2	Nega	Posi	31.5	70.1
VGA 640 × 480	25.2	Nega	Nega	31.5	60.0
VGA Text 720 × 400	28.3	Nega	Posi	31.5	70.1
Macintosh 640 × 480	30.2	Nega	Nega	35.0	66.7
Macintosh 832 × 624	57.3	Posi	Posi	49.7	74.6
Macintosh 1152 × 870	100.0	Nega	Nega	68.7	75.1
Macintosh 1280 × 960	126.2	Posi	Posi	74.8	74.8
VESA 640 × 480	31.5	Nega	Nega	37.9	72.8
VESA 640 × 480	31.5	Nega	Nega	37.5	75.0
VESA 800 × 600	36.0	Posi	Posi	35.2	56.3
VESA 800 × 600	40.0	Posi	Posi	37.9	60.3
VESA 800 × 600	50.0	Posi	Posi	48.1	72.2
VESA 800 × 600	49.5	Posi	Posi	46.9	75.0

Mode	Dot Clock MHz	Sync Polarity		Frequencies	
		H	V	fH: kHz	fV: Hz
VESA 1024 × 768	65.0	Nega	Nega	48.4	60.0
VESA 1024 × 768	75.0	Nega	Nega	56.5	70.1
VESA 1024 × 768	78.8	Posi	Posi	60.0	75.0
VESA 1152 × 864	108.0	Posi	Posi	67.5	75.0
VESA 1280 × 960	108.0	Posi	Posi	60.0	60.0
VESA 1280 × 1024	108.0	Posi	Posi	64.0	60.0
VESA 1280 × 1024	135.0	Posi	Posi	80.0	75.0

[Applicable to gray cabinet version only.]



Congratulations!

The display you have just purchased carries the TCO'03 Displays label. This means that your display is designed, manufactured and tested according to some of the strictest quality and environmental requirements in the world. This makes for a high performance product, designed with the user in focus that also minimizes the Impact on our natural environment.

Some of the features of the TCO'03 Display requirements:

Ergonomics

- Good visual ergonomics and image quality in order to improve the working environment for the user and to reduce sight and strain problems. Important parameters are luminance, contrast, resolution, reflectance, colour rendition and image stability.

Energy

- Energy-saving mode after a certain time - beneficial both for the user and environment
- Electrical safety
- Emissions
Electromagnetic fields
- Noise emissions

Ecology

- The products must be prepared for recycling and the manufacturer must have a certified environmental management system such as EMAS or ISO 14000
- Restrictions on
 - chlorinated and brominated flame retardants and polymers
 - heavy metals such as cadmium, mercury and lead.

The requirements included in this label have been developed by TCO Development in co-operation with scientists, experts, users as well as manufacturers all over the world. Since the end of the 1980s TCO has been involved in influencing the development of IT equipment in a more user-friendly direction. Our labeling system with displays in 1992 and is now requested by users and IT-manufacturers all over the world.

For more information, please visit
www.tcodevelopment.com



Congratulations!

You have just purchased a TCO'99 approved and labelled product! Your choice has provided you with a product developed for professional use. Your purchase has also contributed to reducing the burden on the environment and also to the further development of environmentally adapted electronics products.

Why do we have environmentally labelled computers?

In many countries, environmental labelling has become an established method for encouraging the adaptation of goods and services to the environment. The main problem, as far as computers and other electronics equipment are concerned, is that environmentally harmful substances are used both in the products and during their manufacture. Since it is not so far possible to satisfactorily recycle the majority of electronics equipment, most of these potentially damaging substances sooner or later enter nature.

There are also other characteristics of a computer, such as energy consumption levels, that are important from the viewpoints of both the work (internal) and natural (external) environments. Since all methods of electricity generation have a negative effect on the environment (e.g. acidic and climate-influencing emissions, radioactive waste), it is vital to save energy. Electronics equipment in offices is often left running continuously and thereby consumes a lot of energy.

What does labelling involve?

This product meets the requirements for the TCO'99 scheme which provides for international and environmental labelling of personal computers. The labelling scheme was developed as a joint effort by the TCO (The Swedish Confederation of Professional Employees), Svenska Naturskyddsforeningen (The Swedish Society for Nature Conservation) and Statens Energimyndighet (The Swedish National Energy Administration).

Approval requirements cover a wide range of issues: environment, ergonomics, usability, emission of electric and magnetic fields, energy consumption and electrical and fire safety.

The environmental demands impose restrictions on the presence and use of heavy metals, brominated and chlorinated flame retardants, CFCs (freons) and chlorinated solvents, among other things. The product must be prepared for recycling and the manufacturer is obliged to have an environmental policy which must be adhered to in each country where the company implements its operational policy.

The energy requirements include a demand that the computer and/or display, after a certain period of inactivity, shall reduce its power consumption to a lower level in one or more stages. The length of time to reactivate the computer shall be reasonable for the user.

Labelled products must meet strict environmental demands, for example, in respect of the reduction of electric and magnetic fields, physical and visual ergonomics and good usability.

You will find a brief summary of the environmental requirements met by this product on the right. The complete environmental criteria document may be ordered from:

TCO Development

SE-114 94 Stockholm, Sweden

Fax: +46 8 782 92 07

Email (Internet): development@tco.se

Current information regarding TCO'99 approved and labelled products may also be obtained via the Internet, using the address: <http://www.tco-info.com/>

Environmental Requirements

Flame retardants

Flame retardants are present in printed circuit boards, cables, wires, casings and housings. Their purpose is to prevent, or at least to delay the spread of fire. Up to 30% of the plastic in a computer casing can consist of flame retardant substances. Most flame retardants contain bromine or chloride, and those flame retardants are chemically related to another group of environmental toxins, PCBs. Both the flame retardants containing bromine or chloride and the PCBs are suspected of giving rise to severe health effects, including reproductive damage in fish-eating birds and mammals, due to the bio-accumulative* processes. Flame retardants have been found in human blood and researchers fear that disturbances in foetus development may occur.

The relevant TCO'99 demand requires that plastic components weighing more than 25 grams must not contain flame retardants with organically bound bromine or chlorine. Flame retardants are allowed in the printed circuit boards since no substitutes are available.

Cadmium**

Cadmium is present in rechargeable batteries and in the colour-generating layers of certain computer displays. Cadmium damages the nervous system and is toxic in high doses.

The relevant TCO'99 requirement states that batteries, the colour-generating layers of display screens and the electrical or electronics components must not contain any cadmium.

Mercury**

Mercury is sometimes found in batteries, relays and switches. It damages the nervous system and is toxic in high doses.

The relevant TCO'99 requirement states that batteries may not contain any mercury. It also demands that mercury is not present in any of the electrical or electronics components associated with the labelled unit.

CFCs (freons)

The relevant TCO'99 requirement states that neither CFCs nor HCFCs may be used during the manufacture and assembly of the product. CFCs (freons) are sometimes used for washing printed circuit boards. CFCs break down ozone and thereby damage the ozone layer in the stratosphere, causing increased reception on earth of ultraviolet light with e.g. increased risks of skin cancer (malignant melanoma) as a consequence.

Lead**

Lead can be found in picture tubes, display screens, solders and capacitors. Lead damages the nervous system and in higher doses, causes lead poisoning.

The relevant TCO'99 requirement permits the inclusion of lead since no replacement has yet been developed.

* Bio-accumulative is defined as substances which accumulate within living organisms.

** Lead, Cadmium and Mercury are heavy metals which are Bio-accumulative.

For U.S.A, Canada, etc. (rated 100-120 Vac) Only

FCC Declaration of Conformity

We, the Responsible Party EIZO NANA O TECHNOLOGIES INC.
 5710 Warland Drive, Cypress, CA 90630
 Phone: (562) 431-5011

declare that the product Trade name: EIZO
 Model: FlexScan L568/L568-AS

is in conformity with Part 15 of the FCC Rules. Operation of this product is subject to the following two conditions: (1) this device may not cause harmful interference, and (2) this device must accept any interference received, including interference that may cause undesired operation.

This equipment has been tested and found to comply with the limits for a Class B digital device, pursuant to Part 15 of the FCC Rules. These limits are designed to provide reasonable protection against harmful interference in a residential installation. This equipment generates, uses, and can radiate radio frequency energy and, if not installed and used in accordance with the instructions, may cause harmful interference to radio communications. However, there is no guarantee that interference will not occur in a particular installation. If this equipment does cause harmful interference to radio or television reception, which can be determined by turning the equipment off and on, the user is encouraged to try to correct the interference by one or more of the following measures.

- * Reorient or relocate the receiving antenna.
- * Increase the separation between the equipment and receiver.
- * Connect the equipment into an outlet on a circuit different from that to which the receiver is connected.
- * Consult the dealer or an experienced radio/TV technician for help.

Changes or modifications not expressly approved by the party responsible for compliance could void the user's authority to operate the equipment.

Note

Use the attached specified cable below or EIZO signal cable with this monitor so as to keep interference within the limits of a Class B digital device.

- AC Cord
- Shielded Signal Cable (enclosed)

Canadian Notice

This Class B digital apparatus complies with Canadian ICES-003.
Cet appareil numérique de le classe B est conforme à la norme NMB-003 du Canada.

Hinweis zur Ergonomie :

Dieser Monitor erfüllt die Anforderungen an die Ergonomie nach EK1-ITB 2000 mit dem Videosignal, 1280 Punkte × 1024 Zeilen, RGB analog, 0,7 Vp-p und mindestens 75,0 Hz Bildwiederholfrequenz, non interlaced. Weiterhin wird aus ergonomischen Gründen empfohlen, die Grundfarbe Blau nicht auf dunklem Untergrund zu verwenden (schlechte Erkennbarkeit, Augenbelastung bei zu geringem Zeichenkontrast.)

Hinweise zur Auswahl des richtigen Schwenkarms für Ihren Monitor

Dieser Monitor ist für Bildschirmarbeitsplätze vorgesehen. Wenn nicht der zum Standardzubehör gehörige Schwenkarm verwendet wird, muss statt dessen ein geeigneter anderer Schwenkarm installiert werden. Bei der Auswahl des Schwenkarms sind die nachstehenden Hinweise zu berücksichtigen:

Der Standfuß muß den nachfolgenden Anforderungen entsprechen:

- a) Der Standfuß muß eine ausreichende mechanische Stabilität zur Aufnahme des Gewichtes vom Bildschirmgerät und des spezifizierten Zubehörs besitzen. Das Gewicht des Bildschirmgerätes und des Zubehörs sind in der zugehörigen Bedienungsanleitung angegeben.
- b) Die Befestigung des Standfusses muß derart erfolgen, daß die oberste Zeile der Bildschirmanzeige nicht höher als die Augenhöhe eines Benutzers in sitzender Position ist.
- c) Im Fall eines stehenden Benutzers muß die Befestigung des Bildschirmgerätes derart erfolgen, daß die Höhe der Bildschirmmitte über dem Boden zwischen 135 – 150 cm beträgt.
- d) Der Standfuß muß die Möglichkeit zur Neigung des Bildschirmgerätes besitzen (max. vorwärts: 5°, min. nach hinten $\geq 5^\circ$).
- e) Der Standfuß muß die Möglichkeit zur Drehung des Bildschirmgerätes besitzen (max. $\pm 180^\circ$). Der maximale Kraftaufwand dafür muß weniger als 100 N betragen.
- f) Der Standfuß muß in der Stellung verharren, in die er manuell bewegt wurde.
- g) Der Glanzgrad des Standfusses muß weniger als 20 Glanzeinheiten betragen (seidenmatt).
- h) Der Standfuß mit Bildschirmgerät muß bei einer Neigung von bis zu 10° aus der normalen aufrechten Position kippstabil sein.

Recycle Auskunft

Die Rücknahme dieses Produktes nach Nutzungsende übernimmt EIZO in Deutschland zusammen mit dem Partner eds-r gmbh rücknahmesysteme. Dort werden die Geräte in ihre Bestandteile zerlegt, die dann der Wiederverwertung zugeführt werden. Um einen Abholtermin zu vereinbaren und die aktuellen Kosten zu erfahren, benutzen Sie bitte folgende Rufnummer: 02153-73 35 00. Weitere Informationen finden Sie auch unter der Internet-Adresse: www.eizo.de.

Recycling Information for customers in Switzerland:

All recycling information is placed in the SWICO's website.
<http://www.swico.ch>

Recycling-Information für Kunden in der Schweiz:

Alle Informationen zum Thema Recycling finden Sie auf der Homepage des Branchenverbandes SWICO.
<http://www.swico.ch>

Renseignements de recyclage pour les clients en Suisse:

Vous trouvez tous les renseignements pour le sujet de recyclage sur la page WEB de l'UNION DE BRAN CHE SWICO.
<http://www.swico.ch>

Recycling Information for customers in USA:

All recycling information is placed in the EIZO Nanao Technologies, Inc's website.
<http://www.eizo.com/contact/index.html>

Återvinnings information för kunder i Sverige:

All information om återvinning finns på Eizo Nordics hemsida:
www.eizo.se