

# User's Manual

# FlexScan<sup>®</sup> SX3031W

Color LCD Monitor

## Important

Please read this User's Manual and Setup Manual (separate volume) carefully to familiarize yourself with safe and effective usage.

## PRECAUTIONS

## CONTENTS

### Chapter 1 Features and Overview

- 1-1 Features
- 1-2 Buttons and Indicators
- 1-3 Functions and Basic Operation

### Chapter 2 Settings and Adjustments

- 2-1 Utility Disk
- 2-2 Display Mode Selection
- 2-3 Color Adjustment
- 2-4 Off Timer/Power Saving Settings
- 2-5 Screen Size Selection
- 2-6 Power Indicator/EIZO Logo Display Setting
- 2-7 Locking Buttons
- 2-8 Setting Adjustment Menu Display
- 2-9 Viewing Information/Setting Language
- 2-10 Beeper Setting
- 2-11 Selecting input signal
- 2-12 Resumption of Default Setting

### Chapter 3 Connecting Cables

- 3-1 Connecting Peripheral USB Devices

### Chapter 4 Troubleshooting

### Chapter 5 Reference

- 5-1 Attaching an Arm
- 5-2 Cleaning
- 5-3 Specifications
- 5-4 Glossary





### How to Setup

Please read the Setup Manual (separate volume)



# SAFETY SYMBOLS

This manual uses the safety symbols below. They denote critical information. Please read them carefully.

	<p><b>WARNING</b> Failure to abide by the information in a WARNING may result in serious injury and can be life threatening.</p>	 <p><b>CAUTION</b> Failure to abide by the information in a CAUTION may result in moderate injury and/or property or product damage.</p>
	<p>Indicates a prohibited action.</p>	
	<p>Indicates a mandatory action that must be followed.</p>	

---

Copyright© 2007 EIZO NANA O CORPORATION All rights reserved.

No part of this manual may be reproduced, stored in a retrieval system, or transmitted, in any form or by any means, electronic, mechanical, or otherwise, without the prior written permission of EIZO NANA O CORPORATION. EIZO NANA O CORPORATION is under no obligation to hold any submitted material or information confidential unless prior arrangements are made pursuant to EIZO NANA O CORPORATION's receipt of said information. Although every effort has been made to ensure that this manual provides up-to-date information, please note that EIZO monitor specifications are subject to change without notice.

---

ENERGY STAR is a U.S. registered mark.  
 Apple and Macintosh are registered trademarks of Apple Inc.  
 VGA is a registered trademark of International Business Machines Corporation.  
 DPMS is a trademark and VESA is a registered trademark of Video Electronics Standards Association.  
 Windows is a registered trademark of Microsoft Corporation.  
 PowerManager is a trademark of EIZO NANA O CORPORATION.  
 FlexScan, ScreenManager, i•Sound and EIZO are registered trademarks of EIZO NANA O CORPORATION in Japan and other countries.

<p>As an ENERGY STAR® Partner, EIZO NANA O CORPORATION has determined that this product meets the ENERGY STAR guidelines for energy efficiency.</p>	
---	---

<p>Product specification may vary with sales areas.          Confirm the specification in the manual written in language of the region of purchase.</p>
---

# PRECAUTIONS

---

## IMPORTANT

- This product has been adjusted specifically for use in the region to which it was originally shipped. If the product is used outside the region, it may not operate as specified in the specifications.
- To ensure personal safety and proper maintenance, please read carefully this section and the caution statements on the monitor.

## [Location of Caution Statement]



 **WARNING**

**Place the unit at the strong and stable place.**

A unit placed on an inadequate surface may fall and cause damage to the unit. If the unit falls, disconnect the power immediately. Do not continue using a damaged unit. Using a damaged unit may cause fire or electric shock.

**Set the unit in an appropriate location.**

Not doing so may result in fire or electric shock.

- Do not place outdoors.
- Do not place in a place where the temperature is too high or too low.
- Do not place in a place where the humidity is too high.
- Do not place in a place where the unit may be exposed to direct sunlight.
- Do not place in a place where the unit may be exposed to rain or water.

**To**

Be sure

Not doing so may result in

**To disconnect the power cord, grasp the plug.**

Tugging on the cord may damage and result in fire or electric shock.

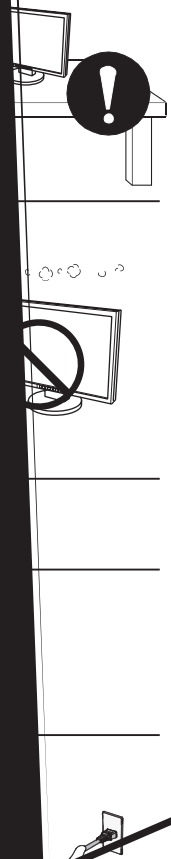

## **WARNING**

---

### **Handle the power cord with care.**

- Do not place the cord underneath the unit or other heavy objects.
- Do not pull on or tie the cord.

If the power cord becomes damaged, stop using it. Use of a damaged cord may result in fire or electric shock.



### **Never touch the plug and power cord if it begins to thunder.**

Touching them may result in electric shock.

### **When attaching an arm stand, please refer to the user's manual of the arm stand and install the unit securely.**

Not doing so may cause the unit to become unattached, which may result in injury or equipment damage. When the unit is dropped, please ask your dealer for advice. Do not continue using a damaged unit. Using a damaged unit may result in fire or electric shock. When reattaching the tilt stand, please use the same screws and tighten them securely.

### **Do not touch a damaged LCD panel directly with bare hands.**

The liquid crystal that may leak from the panel is poisonous if it enters the eyes or mouth. If any part of the skin or body comes in direct contact with the panel, please wash thoroughly. If some physical symptoms result, please consult your doctor.



## CAUTION

---

### **Handle with care when carrying the unit.**

Disconnect the power cord and cables when moving the unit. Moving the unit with the cord attached is dangerous. It may result in injury.

---

### **When handling the unit, grip the unit firmly by two people ensuring the panel faces outward before lifting.**

Dropping the unit may result in injury or equipment damage.

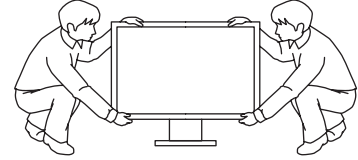

### **Do not block the ventilation slots on the cabinet.**

- Do not place any objects on the ventilation slots.
- Do not install the unit in a closed space.
- Do not use the unit laid down or upside down.

Blocking the ventilation slots prevents proper airflow and may result in fire, electric shock, or equipment damage.

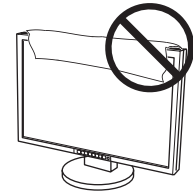

### **Do not touch the plug with wet hands.**

Doing so may result in electrical shock.



### **Use an easily accessible power outlet.**

This will ensure that you can disconnect the power quickly in case of a problem.

---

### **Periodically clean the area around the plug.**

Dust, water, or oil on the plug may result in fire.

---

### **Unplug the unit before cleaning it.**

Cleaning the unit while it is plugged into a power outlet may result in electric shock.

---

**If you plan to leave the unit unused for an extended period, disconnect the power cord from the wall socket after turning off the power switch for the safety and the power conservation.**

---

## LCD Panel

---

In order to suppress the luminosity change by long-term use and to maintain the stable luminosity, use of a monitor in lower brightness is recommended.

---

The LCD panel is manufactured using high-precision technology. However, note that the appearance of any missing pixels or lit pixels does not indicate damage to the LCD monitor.

Percentage of effective pixels: 99.9994% or higher.

---

The backlight of the LCD panel has a fixed life span. When the screen becomes dark or begins to flicker, please contact your dealer.

---

Do not press on the panel or edge of the frame strongly, as this may result in the display malfunction, such as the interference patterns, etc. If pressure is continually applied to the LCD panel, it may deteriorate or damage your LCD panel. (If the pressure marks remain on the LCD panel, leave the monitor with a white or black screen. The symptom may disappear.)

---

Do not scratch or press on the panel with any sharp objects, such as a pencil or pen as this may result in damage to the panel. Do not attempt to brush with tissues as this may scratch the LCD panel.

---

When the screen image is changed after displaying the same image for extended periods of time, an afterimage may appear. Use the screen saver or timer to avoid displaying the same image for extended periods of time.

---

When the monitor is cold and brought into a room or the room temperature goes up quickly, dew condensation may occur inside and outside the monitor. In that case, do not turn the monitor on and wait until dew condensation disappears, otherwise it may cause damage to the monitor.

---

## To use the monitor comfortably

---

An excessively dark or bright screen may affect your eyes. Adjust the brightness of the monitor according to the environmental conditions.

---

Staring at the monitor for a long time tires your eyes. Take a 10-minute rest every hour.

---

# CONTENTS

<b>PRECAUTIONS</b> .....	<b>1</b>	<b>2-7 Locking Buttons</b> .....	<b>16</b>
LCD Panel.....	5	• To lock operation [Adjustment Lock].....	16
To use the monitor comfortably .....	5	<b>2-8 Setting Adjustment Menu Display</b> .....	<b>17</b>
<b>Chapter 1 Features and Overview</b> .....	<b>7</b>	• To update menu settings [Menu Size/Menu Position/Menu Off Timer/ Translucent].....	17
<b>1-1 Features</b> .....	7	<b>2-9 Viewing Information/Setting Language</b> .....	<b>18</b>
<b>1-2 Buttons and Indicators</b> .....	7	• To check settings, usage time, etc. [Information].....	18
<b>1-3 Functions and Basic Operation</b> .....	8	• To set a language to be displayed [Language] .....	18
<b>Chapter 2 Settings and Adjustments</b> .....	<b>10</b>	<b>2-10 Beeper Setting</b> .....	<b>18</b>
<b>2-1 Utility Disk</b> .....	<b>10</b>	• To set the beeper [Beep] .....	18
• Disk contents and software overview .....	10	<b>2-11 Selecting Input Signal</b> .....	<b>19</b>
• To use ScreenManager Pro for LCD .....	10	• To select input signal [Input Signal].....	19
<b>2-2 Display Mode Selection</b> .....	<b>10</b>	<b>2-12 Resumption of Default Setting</b> .....	<b>19</b>
• To choose Dual Display [Display Setup].....	10	• To reset color adjustment [Reset].....	19
<b>2-3 Color Adjustment</b> .....	<b>11</b>	• To reset all settings [Reset] .....	19
<b>Simple Adjustment [FineContrast Mode]</b> .....	<b>11</b>	<b>Chapter 3 Connecting Cables</b> .....	<b>20</b>
• FineContrast mode.....	11	<b>3-1 Connecting Peripheral USB Devices</b> .....	<b>20</b>
• To select FineContrast mode.....	11	<b>Chapter 4 Troubleshooting</b> .....	<b>21</b>
• To update color setting of FineContrast mode... 11		<b>Chapter 5 Reference</b> .....	<b>23</b>
<b>Advanced Adjustments [Adjustment Menu]</b> .....	<b>12</b>	<b>5-1 Attaching an Arm</b> .....	<b>23</b>
• To select an appropriate mode for images .....	12	<b>5-2 Cleaning</b> .....	<b>23</b>
• To set/adjust color .....	13	<b>5-3 Specifications</b> .....	<b>24</b>
<b>2-4 Off Timer/Power Saving Settings</b> .....	<b>14</b>	<b>5-4 Glossary</b> .....	<b>27</b>
• To set monitor power-off time [Off Timer] .....	14		
• To set monitor power-saving [DVI DMPM] .....	14		
<b>2-5 Screen Size Selection</b> .....	<b>15</b>		
• To change screen size [Screen Size] .....	15		
• To adjust brightness of non-display area [Border Intensity] .....	15		
• To modify blurred characters/lines [Smoothing] .....	15		
<b>2-6 Power Indicator/EIZO Logo Display     Settings</b> .....	<b>16</b>		
• To turn off the Power indicator while a screen is displayed [Power Indicator] .....	16		
• To display EIZO logo [EIZO Logo Appearing Function].....	16		



# Chapter 1 Features and Overview

Thank you very much for choosing an EIZO color LCD monitor.

## 1-1 Features

- 30 inch class wide screen format LCD
- WQXGA (2560 × 1600) display compliant (SIGNAL1)
- HDCP signal (SIGNAL2) compliant
- Dual-display compliant by introducing dual-input system (DVI-D × 2 connectors)
- DVI digital input (TMDS) compliant
- Horizontal scan frequency: 31 - 100 kHz
- Vertical scan frequency: 59 - 61 Hz (VGA TEXT: 69 - 71 Hz)
- Resolution: 2560 dots × 1600 lines
- Compatible with frame synchronization mode (59 - 61 Hz)
- Smoothing (soft - sharp) function
- FineContrast mode to allow the best mode for screen display
- The utility software “ScreenManager Pro for LCD” (for Windows) to control the monitor from a PC with mouse/keyboard is included (refer to the EIZO LCD Utility Disk).

## 1-2 Buttons and Indicators

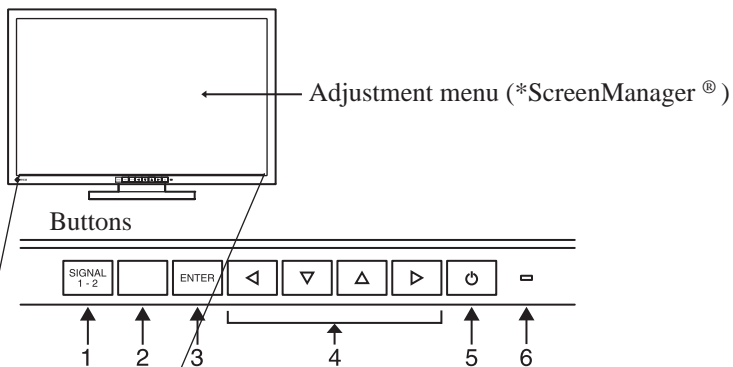

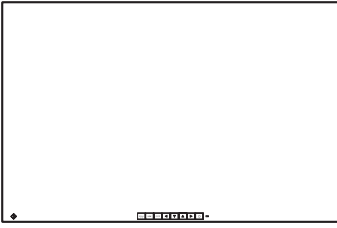

## To make useful settings/adjustments

**ENTER** Adjustment menu (Refer to below for operation)

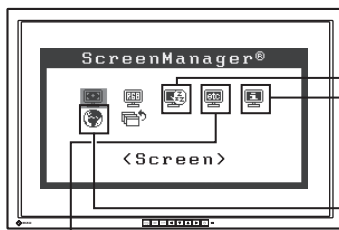

**Others**

**<Screen Size>**

**Screen Size Selection**

- To change screen size  
[Screen Size] ..... see page 15
- To adjust brightness of non-display area  
[Border Intensity] ..... see page 15

**Selecting Input Signal**

- To select input signal  
[Input Signal] ..... see page 19

**Beeper setting**

- To set the beeper [Beep] ..... see page 18

**Off Timer Setting**

- To set monitor power-off time  
[Off Timer] ..... see page 14

**Power Indicator Setting**

- To turn off the Power indicator while a screen is displayed  
[Power Indicator] ..... see page 16

**Setting Adjustment Menu Display**

- To update menu settings [Menu Size/Menu Position/Menu Off Timer/Translucent] ..... see page 17

**Resumption of Default Setting**

- To reset all settings [Reset] ..... see page 19

**Power Saving Setting** Page 14

**PowerManager™**

Set  
 DVI DMPM  
 Off

- To set monitor power-saving [DVI DMPM]

**Viewing Information** Page 18

**Information(1/3)**

Signal 1  
 2560x1600  
 fD: 268.5MHz  
 fH: 98.7kHz  
 fV: 60.0Hz

- To check settings, usage time, etc. [Information]

---

**Setting Language**

**Language**

English     Deutsch  
 Français     Español  
 Italiano     Svenska  
 简体中文     繁體中文  
 日本語

- To set a language to be displayed [Language]

**EIZO Logo Display Setting**

- To display EIZO logo [EIZO Logo Appearing Function] ..... see page 16

**Locking Buttons**

- To lock operation  
[Adjustment Lock] ..... see page 16

**Display Mode Selection**

- To choose Dual Display  
[Display Setup] ..... see page 10

## Basic operation of Adjustment menu

### [Displaying Adjustment menu and selecting function]

- Press **ENTER**. The Main menu appears.
- Select a function with **▲** / **▼** / **◀** / **▶**, and press **ENTER**. The Sub menu appears.
- Select a function with **▲** / **▼** / **◀** / **▶**, and press **ENTER**. The adjustment/setting menu appears.
- Adjust the selected item with **▲** / **▼** / **◀** / **▶**, and press **ENTER**. The setting is saved.

### [Exiting Adjustment menu]

- Choose <Return> from the Sub menu and press **ENTER**. The Main menu appears.
- Choose <Exit> from the Main menu and press **ENTER**. The Adjustment menu quits.

#### NOTE

- The Adjustment menu can also be exited by pressing **ENTER** twice quickly.
- <Exit> or <Return> can also be selected by pressing the **▼** button twice in the Main menu or Sub menu.

# Chapter 2 Settings and Adjustments

## 2-1 Utility Disk

An “EIZO LCD Utility Disk” (CD-ROM) is supplied with the monitor. The following table shows the disk contents and the overview of the application software programs.

### • Disk contents and software overview

The disk includes color profiles, application software programs for adjustment, and User's Manual. Refer to “Readme.txt” or the “Readme” file on the disk for software startup procedures or file access procedures.

Item	Overview	For Windows	For Macintosh
A “Readme.txt” or “Readme” file			
Color Profiles (ICC Profiles)	A specific file including the color characteristic information for the monitor.	✓	✓
ScreenManager Pro for LCD (for Windows)	A utility software program to control monitor adjustments from a PC using its mouse and keyboard. (A PC must be connected to the monitor with the supplied USB cable.) Refer to the description later.	✓	—
WindowMovie Checker Software	WindowMovie is a function of ScreenManager Pro for LCD. For more information, refer to the User's Manual of ScreenManager Pro for LCD on the disk.		
User's Manual of this monitor (PDF file)			

### • To use ScreenManager Pro for LCD



For the installation and use of ScreenManager Pro for LCD, refer to its User's Manual on the disk.

To adjust the monitor using ScreenManager Pro for LCD, connect a PC to the monitor with the supplied USB cable.

For details, refer to Chapter 3 Connecting Cables, item 3-1 Connecting Peripheral USB Devices (page 20).

## 2-2 Display Mode Selection

### • To choose Dual Display [Display Setup]

- (1) Check that the monitor and the PC are powered off.
- (2) Press  and  simultaneously to display the Display Setup menu.  
Single Display: Press [Single Display].  
Dual Display: Press [Dual Display].
- (3) Press .
- (4) Turn on the PC.  
The display appears on the screen.

#### Attention

- Default setting: Single Display

## 2-3 Color Adjustment

### Simple Adjustment [FineContrast Mode]

This function allows you to select the best display mode for monitor brightness, etc.

#### • FineContrast mode

An appropriate display mode is selectable out of five modes.

Mode	Purpose
Custom	Available for making desired setting.
sRGB	Suitable for color matching with sRGB compatible peripherals.
Text	Suitable for displaying texts for word processing or spreadsheets.
Picture	Suitable for displaying images such as photos or picture images.
Movie	Suitable for playing back animated images.

#### FineContrast menu

Example) Custom

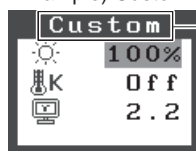

Displays current mode.

Displays current settings of brightness, color temperature, and gamma.

#### • To select FineContrast mode

- (1) Press **MODE**.

The fine contrast mode changes at every time pressing the **MODE**.



- (2) Choose desired mode and press **ENTER**.

The setting completes.

#### • To update color setting of FineContrast mode

<Brightness>, <Temperature>, and <Gamma> can be set or adjusted.

- (1) Choose a desired function from the FineContrast menu with **▲** or **▼**.

- (2) Adjust the selected function with **◀** or **▶**, and press **ENTER**.

The adjustment is completed.

#### NOTE

- The Adjustment menu and the FineContrast menu cannot be displayed at the same time.

#### Attention

- Color temperature values and gamma values are fixed in some modes. Set them as shown in “To select an appropriate mode for images” on page 12.

#### NOTE









- The <Color> menu of the Adjustment menu allows advanced color adjustments for each mode. Refer to “To select an appropriate mode for images” on page 12.

## Advanced Adjustments [Adjustment Menu]



Independent setting and saving of color adjustment are available for each FineContrast mode.

- **To select an appropriate mode for images**

✓: Adjustment available    -: Invalid for adjustment

Icon	Function		FineContrast mode				
			Custom	sRGB	Text	Picture	Movie
	Brightness	*	✓	✓	✓	✓	✓
	Temperature	*	✓	-	✓	✓	✓
	Gamma	*	✓	-	✓	-	-
	Saturation		✓	-	✓	✓	✓
	Hue		✓	-	✓	✓	✓
	Gain		✓	-	-	-	-
	6 Colors		✓	-	-	-	-
	Reset		✓	✓	✓	✓	✓

\* These items can also be set or adjusted with the FineContrast menu.

Menu	Description	Adjustment range
Gain 	To adjust red, green, and blue to a desired color tone respectively	0 to 100% Adjust the respective brightness of red/green/blue to make a desired color tone. Display an image with white or gray background for adjustment.
	<b>NOTE</b> • Values shown in percentage are available only as reference.	
6 Colors 	To adjust <Hue> and <Saturation> in Red, Yellow, Green, Cyan, Blue, and Magenta respectively	Hue: -100 to 100 Saturation: -100 to 100
Reset 	To reset the color settings of the selected FineContrast mode to the default settings	

• **To set/adjust color**

- (1) Choose <Color> from the Adjustment menu, and press .
  - (2) Select a desired function from the <Color> menu, and press .  
The selected function menu appears.
  - (3) Adjust the selected item with  /  /  / , and press .
- The adjustment is completed.

## 2-4 Off Timer/Power Saving Settings

### • To set monitor power-off time [Off Timer]







This function allows the monitor to automatically turn off after a specified time has passed. This function serves to reduce afterimages caused when the monitor screen is left on for a long time period without use. Use this function when an image is displayed throughout the day.

#### [Off Timer System]

Timer	Monitor	Power Indicator
ON time (1H - 23H)	Operating	Blue
Last 15 min. in "ON time"	Advance Notice*	Flashing blue
"ON time" expired	Power Off	Off

\* When  is pressed during the advance notice period, the monitor continues to operate for additional 90 minutes. Extension of operation time can be set without limitation.

#### [Procedure]

- (1) Choose <Others> from the Adjustment menu, and press .
- (2) Choose <Off Timer> from the <Others> menu, and press .  
The <Off Timer> menu appears.
- (3) Select "Enable" with  or .
- (4) Set a monitor ON time (1 to 23 hours) with  or , and press .  
The Off Timer setting is completed.

#### [Resumption Procedure]

- Press .

### • To set monitor power-saving [DVI DMPM]





This monitor complies with the DVI DMPM standard.

#### [Power Saving System]

The monitor enters the power saving mode in five seconds in connection with the PC setting.

PC	Monitor	Power Indicator
Operating	Operating	Blue
Power saving	Power saving	Orange

#### [Procedure]

- (1) Choose <PowerManager> from the Adjustment menu, and press .  
The <Set> menu appears.
- (2) Select "DVI DMPM" with  or , and press .  
The power saving setting is completed.

#### [Resumption Procedure]

- Operate the mouse or keyboard to resume the normal screen.

#### Attention

- The Off Timer functions even in the power saving mode, but the advance notice is disabled. The monitor power is turned off without advance notice.

#### Attention

- Unplugging the power cord completely shuts off power supply to the monitor.
- USB compliant devices connected to the monitor work even if the monitor is in the power saving mode. Therefore, power consumption of the monitor varies with connected devices even in the power saving mode.



## 2-5 Screen Size Selection

### • To change screen size [Screen Size]

The image with the resolution other than the recommended resolution is displayed in full screen automatically. You can change the screen size by using <Screen size> from <Others> menu.

Menu	Function
Full (default setting)	Displays an image in full screen. Images are distorted in some cases because the vertical rate is not equal to the horizontal rate.
Enlarged	Displays an image in full screen. In some cases, a blank horizontal or vertical border appears to equalize the vertical rate and the horizontal rate.
Normal	Displays images with the specified resolution.

Example: Image size 1280 × 1024 when setting <Single Display> in <Display Setup>.

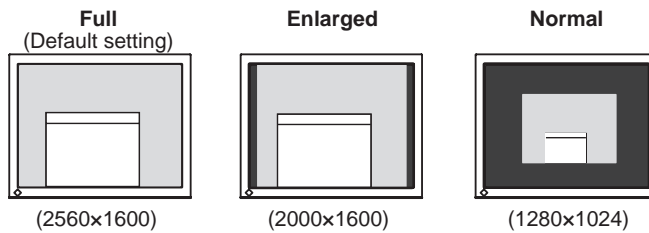

### [Procedure]

- (1) Choose <Others> from the Adjustment menu, and press .
- (2) Choose <Screen Size> from the <Others> menu, and press .
- The screen size setting window appears.
- (3) Select “Full,” “Enlarged,” or “Normal” with  or , and press .
- The screen size setting is completed.

### • To adjust brightness of non-display area [Border Intensity]

A border (black area with no image) around the image appears in the “Normal” or “Enlarged” mode.

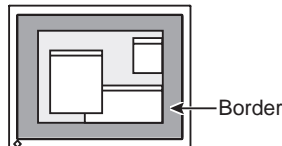

- (1) Choose <Others> from the Adjustment menu, and press .
- (2) Choose <Border Intensity> from the <Others> menu, and press .
- The <Border Intensity> menu appears.
- (3) Adjust border intensity with  or , and press .
- The border intensity adjustment is completed.

### • To modify blurred characters/lines [Smoothing]

When a low-resolution image is displayed in the “Full” or “Enlarged” mode, the characters or lines of the displayed image may be blurred.

- (1) Choose <Screen> from the Adjustment menu, and press .
- (2) Choose <Smoothing> from the <Screen> menu, and press .
- The <Smoothing> menu appears.
- (3) Select a suitable level from 1 to 5 (where 1 = soft and 5 = sharp) with  or , and press .
- The smoothing adjustment is completed.

### Attention

- Smoothing setting may not be required depending on the display resolution. (You cannot choose the smoothing icon.)

## 2-6 Power Indicator/EIZO Logo Display Settings

### • To turn off the Power indicator while a screen is displayed [Power Indicator]

This function enables to turn off the Power indicator (blue) while a screen is displayed.

- (1) Choose <Others> from the Adjustment menu, and press **ENTER**.
- (2) Choose <Power Indicator> from the <Others> menu, and press **ENTER**.  
The <Power Indicator> menu appears.
- (3) Select "Disable" with **▲** or **▼**, and press **ENTER**.  
The Power Indicator setting is completed.

### • To display EIZO logo [EIZO Logo Appearing Function]

When this unit is turned on, the EIZO logo appears at the center of the screen. Selection to display or not to display the logo is available with this function.

#### [Procedure]

- (1) Press **⏻** to power off the unit.
- (2) Press **⏻** again while pressing **ENTER**.  
The EIZO logo does not appear on the screen.

#### [Resetting]

- (1) Press **⏻** to power off the unit.
- (2) Press **⏻** again while pressing **ENTER**.  
The logo appears again.

## 2-7 Locking Buttons

### • To lock operation [Adjustment Lock]

This function locks the buttons to retain the status adjusted or set once.

Buttons that can be locked	<ul style="list-style-type: none"> <li>• <b>ENTER</b> (Enter button) Adjustments/settings using Adjustment menu</li> </ul>
Buttons that cannot be locked	<ul style="list-style-type: none"> <li>• <b>MODE</b> FineContrast mode selection/adjustment using control buttons</li> <li>• <b>◀</b> / <b>▶</b> Brightness adjustment using control buttons</li> <li>• <b>SIGNAL</b> (Input Signal Selection button), <b>MODE</b> (Mode button), <b>⏻</b> (Power button).</li> </ul>

- (1) Press **⏻** to turn off the unit.
- (2) Press **⏻** again while pressing **MODE**.  
The screen is displayed with the adjustment lock.

#### [Unlocking]

- (1) Press **⏻** to turn off the unit.
- (2) Press **⏻** again while pressing **MODE**.  
The screen is displayed with the adjustment lock released.

#### NOTE

- The Power indicator lights up at power on with the default setting.

#### NOTE

- The logo appears with the default setting.

## 2-8 Setting Adjustment Menu Display

- To update menu settings [Menu Size/Menu Position/Menu Off Timer/Translucent]

### Menu Size

Change the Adjustment menu size using the following procedure.

- (1) Choose <Others> from the Adjustment menu, and press .
- (2) Choose <Menu Settings> from the <Others> menu, and press .
- (3) Choose <Menu Size> from the <Menu Settings> menu, and press   
The <Menu Size> menu appears.
- (4) Select "Normal/Enlarged" using  or , and press   
The menu size setting is completed.

### Menu Position

Adjust the menu position using the following procedure.

- (1) Choose <Others> from the Adjustment menu, and press .
- (2) Choose <Menu Settings> from the <Others> menu, and press .
- (3) Choose <Menu Position> from the <Menu Settings> menu, and press   
The <Menu Position> menu appears.
- (4) Select a menu position with  /  /  / , and press   
The menu position setting is completed.

### Menu Off Timer

Set the menu display time using the following procedure.

- (1) Choose <Others> from the Adjustment menu, and press .
- (2) Choose <Menu Settings> from the <Others> menu, and press .
- (3) Choose <Menu Off Timer> from the <Menu Settings> menu, and press   
The <Menu Off Timer> menu appears.
- (4) Select "Enable" with  or .
- (5) Choose an Off Time (15/30/45/60 seconds) with  or , and press   
The menu off timer setting is completed.

### Translucent

Set the transparency for menu display using the following procedure.

- (1) Choose <Others> from the Adjustment menu, and press .
- (2) Choose <Menu Settings> from the <Others> menu, and press .
- (3) Choose <Translucent> from the <Menu Settings> menu, and press   
The <Translucent> menu appears.
- (4) Adjust the transparency for menu display with  or , and press   
The transparency setting is completed.

## 2-9 Viewing Information/Setting Language

### • To check settings, usage time, etc. [Information]

This function allows you to check settings, model name, serial number, display mode (see page 10), and usage time of the monitor.

- (1) Choose <Information> from the Adjustment menu, and press .  
The <Information> menu appears.
- (2) Then, press  to check settings, etc.

### • To set a language to be displayed [Language]

Select the Adjustment menu language.

#### Selectable languages

English/German/French/Spanish/Italian/Swedish/Simplified Chinese/  
Traditional Chinese/Japanese

- (1) Choose <Language> menu from the Adjustment menu, and press .  
The <Language> menu appears.
- (2) Choose a language with  /  /  / , and press .  
The language setting is completed.

## 2-10 Beeper Setting

### • To set the beeper [Beep]

Set the beeper on/off for operation tone of the switches, connection error, etc.

Sound type	Conditions for beeping
Short beep	<ul style="list-style-type: none"><li>• When <input type="button" value="MODE"/> is pressed.</li><li>• When an item is selected with <input type="button" value="ENTER"/>.</li><li>• When a maximum or minimum value is set with the control switches.</li><li>• When <input type="button" value="SIGNAL 1-2"/> is pressed.</li></ul>
Long beep	<ul style="list-style-type: none"><li>• When registration is performed with <input type="button" value="ENTER"/>.</li></ul>
Consecutive beeps	<ul style="list-style-type: none"><li>• When the monitor is not connected correctly.</li><li>• When the PC is not turned on.</li><li>• When no signal is received.</li><li>• When a frequency out of the specified range is received.</li></ul>
Beep-beep once every 15 seconds	<ul style="list-style-type: none"><li>• 15 minutes before the power off time set by "Off Timer" (advance notice time)</li></ul>

- (1) Choose <Others> from the Adjustment menu, and press .
  - (2) Choose <Beep> from the <Others> menu, and press .
  - (3) Select On or Off with  or , and press .
- The beep setting is completed.

#### NOTE

- The usage time is not always "0" when you purchase the monitor due to factory inspection.

#### Attention

- The information is displayed in the following order; settings, SIGNAL1, SIGNAL2 display mode (see page 10) and model name, serial No, and usage time of the monitor.

## 2-11 Selecting Input Signal

### • To select input signal [Input Signal]

This function allows you to select the signal displayed on the monitor.

- (1) Choose <Other> from the Adjustment menu, and press .
- (2) Select <Input Signal> with  and , and press .
- <Input Signal> menu appears.
- (3) Select <Auto/Manual> with  or , and press .

## 2-12 Resumption of Default Setting

### • To reset color adjustment [Reset]

The hue in the color mode currently set will revert to the default settings (factory settings).

- (1) Choose <Color> from the Adjustment menu, and press .
- (2) Choose <Reset> from the <Color> menu and press .
- The <Reset> menu appears.
- (3) Select <Reset> with  or , and press .
- The reset operation is completed.

### • To reset all settings [Reset]

Reset all adjustments/settings to the factory default settings.

- (1) Choose <Others> from the Adjustment menu, and press .
- (2) Choose <Reset> from the <Others> menu, and press .
- The <Reset> menu appears.
- (3) Select <Reset> with  or , and press .
- The reset operation is completed.

#### NOTE

- When no input signal is received on both SIGNAL1 and SIGNAL2 port, the signal port selecting function is performed at every two seconds.

#### NOTE

- For default settings, refer to “Main default settings (factory settings)” on page 25.

# Chapter 3 Connecting Cables

## 3-1 Connecting Peripheral USB Devices

This monitor has a hub compatible with USB. Connected to a PC compatible with USB or another USB hub, this monitor functions as a USB hub allowing connection to peripheral USB devices.

### • Required System Environment

- (1) A PC equipped with a USB port or another USB hub connected to a USB compatible PC
- (2) Windows 2000/XP/Vista or Mac OS 9.2.2 and Mac OS X 10.2 or later
- (3) EIZO USB cable (MD-C93)

### • Connection Procedure (Setup of USB Function)

- (1) Connect the monitor first to a PC using the signal cable, and run the PC.
- (2) Connect the supplied USB cable between the downstream USB port of a USB compatible PC (or another USB hub) and the monitor's upstream USB port.
- (3) When the USB function setup is completed, the monitor functions as a USB hub allowing connection to various peripheral USB devices through its downstream USB ports.

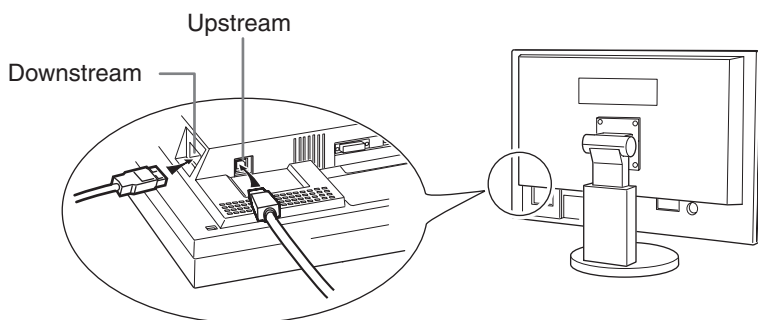

The USB function is set up automatically upon connection of the USB cable.

### Attention

- This monitor may not work depending on PC, OS or peripheral devices to be used.  
For USB compatibility of peripheral devices, contact their manufactures.
- If the monitor is in the power saving mode, or if the monitor is connected to the power outlet with the monitor turned off, all the devices connected to the USB ports (upstream and downstream) work. Therefore, power consumption of the monitor varies with connected devices even in the power saving mode.



Problems	Possible cause and remedy
<b>10. The [Smoothing] icon on the Adjustment menu [Screen] cannot be selected.</b>	<ul style="list-style-type: none"> <li>• Smoothing setting may not be required depending on the display resolution. (You cannot choose the smoothing icon.)</li> </ul>
<b>11. The Main menu of Adjustment menu does not start.</b>	<ul style="list-style-type: none"> <li>• Check for Adjustment Lock function.</li> <li>• Check whether the FineContrast menu is running. (Refer to “Simple adjustment [FineContrast mode]” on page 14.)</li> </ul>
<b>12. USB function cannot be set up.</b>	<ul style="list-style-type: none"> <li>• Check whether the USB cable is connected correctly.</li> <li>• Check whether the PC and OS are USB compliant. (For USB compliance of the respective devices, consult their manufacturers.)</li> <li>• Check the PC’s BIOS setting for USB when using Windows. Refer to the manual of the PC for details.</li> </ul>



# Chapter 5 Reference

## 5-1 Attaching an Arm

The stand can be removed and replaced with an arm (or another stand) to be attached to the monitor.

### [Attaching]

**1** Lay the LCD monitor on a soft cloth spread over on a stable surface with the panel surface facing down.

**2** Remove the stand. (Prepare a screwdriver.)

Unscrew the four screws securing the unit and the stand with the screwdriver.

**3** Attach the monitor to the arm or stand.

Secure the monitor to the arm or stand using the screws specified in the user's manual of the arm or stand.

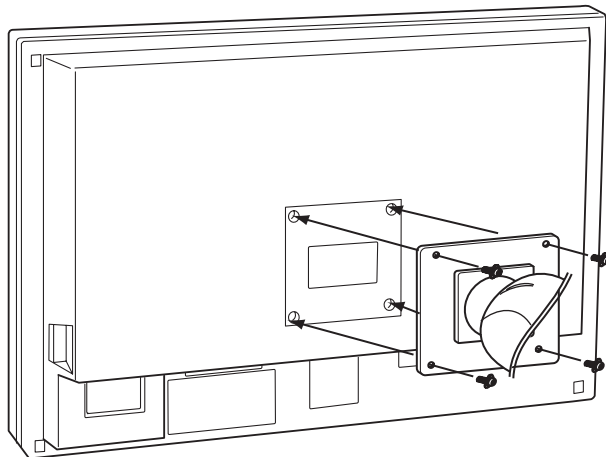

## 5-2 Cleaning

Clean the monitor periodically to keep the monitor clean and extend its life.

### Cabinet

Clean the cabinet with a soft cloth dampened with little mild detergent.

### LCD Panel

- Clean the LCD panel with a soft cloth such as cotton cloth or lens cleaning paper.
- Remove persistent stains gently with a cloth dampened with little water, and then clean the LCD panel again with a dry cloth for better finishing.

### Attention

- When attaching an arm or stand, follow the instructions of their user's manual.
- When using another manufacturer's arm or stand, confirm the following in advance and select one conforming to the VESA standard. Use M4 × 12 mm screws supplied with the monitor.
  - Clearance between the screw holes: 100 mm × 100 mm
  - Thickness of plate: 2.6 mm
  - Strong enough to support weight of the monitor unit (except the stand) and attachments such as cables.
- Attach an arm or stand to meet the following tilt angles of the monitor.
  - Up 45 degrees, down 45 degrees (Within operating range)
- Connect the cables after attaching an arm.

### Attention

- Never use any solvents or chemicals, such as thinner, benzene, wax, alcohol, and abrasive cleaner, which may damage the cabinet or LCD panel.

### NOTE

- Optional ScreenCleaner is recommended for cleaning the panel surface.

## 5-3 Specifications

LCD Panel	29.8-inch (76 cm) TFT color LCD with anti-glare hard coating Viewing angle: Vertical 178°, Horizontal 178° (CR: 10 or more)
Dot Pitch	0.2505 mm
Horizontal Scan Frequency	31 - 100 kHz
Vertical Scan Frequency	59 - 61 Hz (VGA TEXT: 69 - 71 Hz)
Resolution	2560 dots × 1600 lines
Max. Dot Clock	269 MHz
Max. Display Colors	16.77 million colors
Display Area (H × V)	641.2 mm × 400.8 mm
Power Supply	100 - 120 VAC ±10% 50/60 Hz, 1.8 A 200 - 240 VAC ±10% 50/60 Hz, 0.8 A
Power Consumption	Max.: 170 W (normal mode) Power saving mode: 2 W or less (for single signal input without USB) Power switch Off: 1 W or less
Input Signal Connectors	SIGNAL 1:DVI-D, Dual Link/SIGNAL 2:DVI-D, Single Link (HDCP compliant)
Digital Signal Transmission System	TMDS (SIGNAL1: Dual Link/SIGNAL2: Single Link)
Video Signal Memory	Digital Signal: 14 (preset: 0)
Plug & Play	VESA DDC 2B/EDID structure 1.3
Dimensions (Main unit)	689 mm (W) × 489.5 mm - 579.5 mm (H) × 272 mm (D) (27.1" (W) × 19.3" - 22.8" (H) × 10.7" (D))
Dimensions (Main unit with i•Sound L3)	689 mm (W) × 520.5 mm - 579.5 mm (H) × 272 mm (D) (27.1" (W) × 20.5" - 22.8" (H) × 10.7" (D))
Dimensions (without stand)	689 mm (W) × 450 mm (H) × 90 mm (D) (27.1" (W) × 17.7" (H) × 3.5" (D))
Weight (Main unit)	15.3 kg (33.7 lbs)
Weight (without stand)	11.1 kg (24.5 lbs)
Environmental Conditions	Operating temperature: 0 °C - 35 °C Storage temperature: -20 °C - 60 °C Relative humidity: 30% - 80% (no condensation)
USB Standard	USB Specification Revision 2.0
USB Port	Upstream port × 1, Downstream port × 2

### Main default settings (factory settings)

Smoothing		3
FineContrast Mode		Custom
PowerManager		DVI DMPM
Screen Size		Full Screen
Input Signal		Auto
Off Timer		Disable
Menu Settings	Menu Size	Normal
	Menu Off Timer	45sec
Beeper		ON
Language		English

### Outside Dimensions (Main unit)

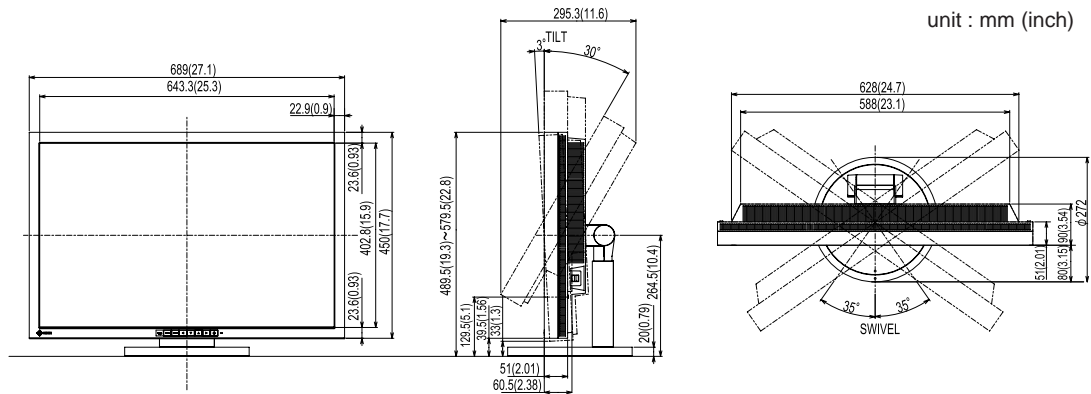

### Outside Dimensions (Main unit with i•Sound L3)

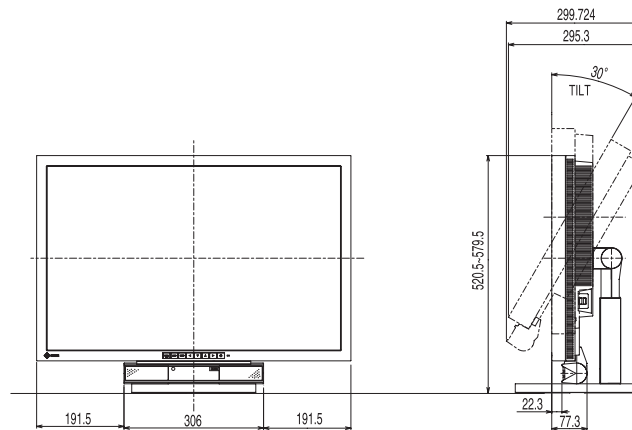

## Connector Pin Assignment

- DVI-D connector

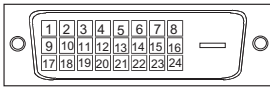

Pin No.	Signal	Pin No.	Signal	Pin No.	Signal
1	T.M.D.S. Data 2-	9	T.M.D.S. Data1-	17	T.M.D.S. Data 0-
2	T.M.D.S. Data 2+	10	T.M.D.S. Data1+	18	T.M.D.S. Data 0+
3	T.M.D.S. Data2/4 Shield	11	T.M.D.S. Data1/3 Shield	19	T.M.D.S. Data 0/5 Shield
4	NC*	12	NC*	20	NC*
5	NC*	13	NC*	21	NC*
6	DDC Clock (SCL)	14	+5V Power	22	T.M.D.S. Clock shield
7	DDC Data (SDA)	15	Ground (return for +5V, Hsync, and Vsync)	23	T.M.D.S. Clock+
8	Analog Vertical Sync	16	Hot Plug Detect	24	T.M.D.S. Clock-

(NC\*: No Connection)

- USB port

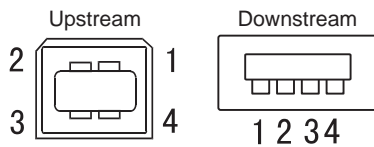

Contact No.	Signal	Remarks
1	VCC	Cable power
2	- Data	Serial data
3	+ Data	Serial data
4	Ground	Cable ground

## Option List

Cleaning Kit	EIZO ScreenCleaner
Signal Cable	FD-C16
Speaker Unit	i•Sound L3

## 5-4 Glossary

### Clock

The analog input monitor needs to reproduce a clock of the same frequency as the dot clock of the graphics system in use, when the analog input signal is converted to a digital signal for image display.

This is called clock adjustment. If the clock pulse is not set correctly, some vertical bars appear on the screen.

### DVI (Digital Visual Interface)

DVI is a digital interface standard. DVI allows direct transmission of the PC's digital data without loss.

This adopts the TMDS transmission system and DVI connectors. There are two types of DVI connectors. One is a DVI-D connector for digital signal input only. The other is a DVI-I connector for both digital and analog signal inputs.

### DVI DMPM (DVI Digital Monitor Power Management)

DVI DMPM is a digital interface power-saving function. The "Monitor ON (operating mode)" and "Active Off (power-saving mode)" are indispensable for DVI DMPM as the monitor's power mode.

### HDCP (High-bandwidth Digital Contents Protection)

Digital signal coding system developed to copy-protect the digital contents, such as video, music, etc. This helps to transmit the digital contents safely by coding the digital contents sent via DVI terminal on the output side and decoding them on the input side.

Any digital contents cannot be reproduced if both of the equipments on the output and input sides are not applicable to HDCP system.

### Gain

This is used to adjust each color parameter for red, green and blue. An LCD monitor displays the color by the light passing through the panel color filter. Red, green and blue are the three primary colors. All the colors on the screen are displayed by combining these three colors. The color tone can be changed by adjusting the light intensity (volume) passing through each color's filter.

### Gamma

Generally, the monitor brightness varies nonlinearly with the input signal level, which is called "Gamma Characteristic". A small gamma value produces a low-contrast image, while a large gamma value produces a high-contrast image.

### Phase

Phase means the sampling timing to convert the analog input signal to a digital signal. Phase adjustment is made to adjust the timing. It is recommended that phase adjustment be made after the clock is adjusted correctly.

### Range Adjustment

Range adjustment controls the signal output levels to display every color gradation. It is recommended that range adjustment be made before color adjustment.

### Resolution

The LCD panel consists of numerous pixels of specified size, which are illuminated to form images. This monitor consists of 2560 horizontal pixels and 1600 vertical pixels. At a resolution of 2560 x 1600, all pixels are illuminated as a full screen (1:1).

### sRGB (Standard RGB)

International standard for "color reproduction and color space" among peripheral devices (such as monitors, printers, digital cameras, scanners). sRGB allows Internet users to closely match colors as a simple color matching means for the Internet use.

### Temperature

Color temperature is a method to measure the white color tone, generally indicated in degrees Kelvin. The screen becomes reddish at a low temperature, and bluish at a high temperature, like the flame temperature.

5000K: Slightly reddish white

6500K: Warm white like paper white

9300K: Slightly bluish white

### TMDS (Transition Minimized Differential Signaling)

A signal transmission system for digital interface.



Congratulations!

The display you have just purchased carries the TCO'03 Displays label. This means that your display is designed, manufactured and tested according to some of the strictest quality and environmental requirements in the world. This makes for a high performance product, designed with the user in focus that also minimizes the Impact on our natural environment.

Some of the features of the TCO'03 Display requirements:

#### Ergonomics

- Good visual ergonomics and image quality in order to improve the working environment for the user and to reduce sight and strain problems. Important parameters are luminance, contrast, resolution, reflectance, colour rendition and image stability.

#### Energy

- Energy-saving mode after a certain time - beneficial both for the user and environment
- Electrical safety

#### Emissions

- Electromagnetic fields
- Noise emissions

#### Ecology

- The products must be prepared for recycling and the manufacturer must have a certified environmental management system such as EMAS or ISO 14000
- Restrictions on
  - chlorinated and brominated flame retardants and polymers
  - heavy metals such as cadmium, mercury and lead.

The requirements included in this label have been developed by TCO Development in co-operation with scientists, experts, users as well as manufacturers all over the world. Since the end of the 1980s TCO has been involved in influencing the development of IT equipment in a more user-friendly direction. Our labeling system with displays in 1992 and is now requested by users and IT-manufacturers all over the world.

**For more information, please visit  
[www.tcodevelopment.com](http://www.tcodevelopment.com)**

For U.S.A. , Canada, etc. (rated 100-120 Vac) Only

## FCC Declaration of Conformity

**We, the Responsible Party**

EIZO NANAOTECHNOLOGIES INC.

5710 Warland Drive, Cypress, CA 90630

Phone: (562) 431-5011

**declare that the product**

Trade name: EIZO

Model: FlexScan SX3031W

**is in conformity with Part 15 of the FCC Rules. Operation of this product is subject to the following two conditions: (1) this device may not cause harmful interference, and (2) this device must accept any interference received, including interference that may cause undesired operation.**

This equipment has been tested and found to comply with the limits for a Class B digital device, pursuant to Part 15 of the FCC Rules. These limits are designed to provide reasonable protection against harmful interference in a residential installation. This equipment generates, uses, and can radiate radio frequency energy and, if not installed and used in accordance with the instructions, may cause harmful interference to radio communications. However, there is no guarantee that interference will not occur in a particular installation. If this equipment does cause harmful interference to radio or television reception, which can be determined by turning the equipment off and on, the user is encouraged to try to correct the interference by one or more of the following measures.

- \* Reorient or relocate the receiving antenna.
- \* Increase the separation between the equipment and receiver.
- \* Connect the equipment into an outlet on a circuit different from that to which the receiver is connected.
- \* Consult the dealer or an experienced radio/TV technician for help.

Changes or modifications not expressly approved by the party responsible for compliance could void the user's authority to operate the equipment.

### Note

Use the attached specified cable below or EIZO signal cable with this monitor so as to keep interference within the limits of a Class B digital device.

- AC Cord
- Shielded Signal Cable (enclosed)

## Canadian Notice

This Class B digital apparatus complies with Canadian ICES-003.

Cet appareil numérique de la classe B est conforme à la norme NMB-003 du Canada.

### **Hinweise zur Auswahl des richtigen Schwenkarms für Ihren Monitor**

Dieser Monitor ist für Bildschirmarbeitsplätze vorgesehen. Wenn nicht der zum Standardzubehör gehörige Schwenkarm verwendet wird, muss statt dessen ein geeigneter anderer Schwenkarm installiert werden. Bei der Auswahl des Schwenkarms sind die nachstehenden Hinweise zu berücksichtigen:

Der Standfuß muß den nachfolgenden Anforderungen entsprechen:

- a) Der Standfuß muß eine ausreichende mechanische Stabilität zur Aufnahme des Gewichtes vom Bildschirmgerät und des spezifizierten Zubehörs besitzen. Das Gewicht des Bildschirmgerätes und des Zubehörs sind in der zugehörigen Bedienungsanleitung angegeben.
- b) Die Befestigung des Standfusses muß derart erfolgen, daß die oberste Zeile der Bildschirmanzeige nicht höher als die Augenhöhe eines Benutzers in sitzender Position ist.
- c) Im Fall eines stehenden Benutzers muß die Befestigung des Bildschirmgerätes derart erfolgen, daß die Höhe der Bildschirmmitte über dem Boden zwischen 135 – 150 cm beträgt.
- d) Der Standfuß muß die Möglichkeit zur Neigung des Bildschirmgerätes besitzen (max. vorwärts: 5°, min. nach hinten  $\geq 5^\circ$ ).
- e) Der Standfuß muß die Möglichkeit zur Drehung des Bildschirmgerätes besitzen (max.  $\pm 180^\circ$ ). Der maximale Kraftaufwand dafür muß weniger als 100 N betragen.
- f) Der Standfuß muß in der Stellung verharren, in die er manuell bewegt wurde.
- g) Der Glanzgrad des Standfusses muß weniger als 20 Glanzeinheiten betragen (seidenmatt).
- h) Der Standfuß mit Bildschirmgerät muß bei einer Neigung von bis zu 10° aus der normalen aufrechten Position kippstabil sein.

### **Hinweis zur Ergonomie :**

Dieser Monitor erfüllt die Anforderungen an die Ergonomie nach EK1-ITB2000 mit dem Videosignal, 2560 × 1600 Digital Eingang und mindestens 60,0 Hz Bildwiederholfrequenz, non interlaced. Weiterhin wird aus ergonomischen Gründen empfohlen, die Grundfarbe Blau nicht auf dunklem Untergrund zu verwenden (schlechte Erkennbarkeit, Augenbelastung bei zu geringem Zeichenkontrast.)

„Maschinenlärminformations-Verordnung 3. GPSGV:

Der höchste Schalldruckpegel beträgt 70 dB(A) oder weniger gemäss EN ISO 7779“





### **EIZO NANA O CORPORATION**

153 Shimokashiwano, Hakusan, Ishikawa 924-8566 Japan  
Phone: +81 76 277 6792 Fax: +81 76 277 6793

### **EIZO NANA O TECHNOLOGIES INC.**

5710 Warland Drive, Cypress, CA 90630, U.S.A.  
Phone: +1 562 431 5011

### **EIZO NANA O AG**

Moosacherstrasse 6, Au CH - 8820 Wadenswil, Switzerland  
Phone: +41-0-44 782 24 40 Fax: +41-0-44 782 24 50

### **Avnet Technology Solutions GmbH**

Lötscher Weg 66, D-41334 Nettetal, Germany  
Phone: +49 2153 733-400 Fax: +49 2153 733-483

<http://www.eizo.com>