

User's Manual

FlexScan[®] S1932

Color LCD Monitor

Important

Please read PRECAUTIONS, this User's Manual, and the Setup Manual (separate volume) carefully to familiarize yourself with safe and effective usage.

- Please refer to the Setup Manual for basic information ranging from connection of the monitor to a PC to using the monitor.
- The latest User's Manual is available for download from our web site:
<http://www.eizo.com>

CONTENTS

Chapter 1 Features and Overview

- 1-1 Features
- 1-2 Buttons and Indicators
- 1-3 Basic operation of Adjustment menu and the icon list

Chapter 2 Settings and Adjustments

- 2-1 Utility Disk
- 2-2 Screen Adjustment
- 2-3 Color Adjustment
- 2-4 Adjusting Sharpness
- 2-5 Setting Enable/Disable for the automatic brightness adjustment function
- 2-6 Turning off the monitor automatically
- 2-7 Locking Buttons
- 2-8 Displaying Monitor Information
- 2-9 Enabling/Disabling DDC/CI communication
- 2-10 Setting Power Indicator ON/OFF
- 2-11 Setting Language
- 2-12 Displaying EIZO logo
- 2-13 Resuming the Default Setting

Chapter 3 Connecting Cables

- 3-1 Connecting Two PCs to the Monitor

Chapter 4 Troubleshooting

Chapter 5 Reference

- 5-1 Attaching an Arm
- 5-2 Power Saving Mode
- 5-3 Cleaning
- 5-4 Specifications
- 5-5 Glossary
- 5-6 Preset Timing

How to use the adjustment menu

Please read the Quick Reference for the operation methods of the adjustment menu and the icon list.



This product has been adjusted specifically for use in the region to which it was originally shipped. If operated outside this region, the product may not perform as stated in the specifications.

Copyright© 2007-2012 EIZO NANA O CORPORATION All rights reserved.

No part of this manual may be reproduced, stored in a retrieval system, or transmitted, in any form or by any means, electronic, mechanical, or otherwise, without the prior written permission of EIZO NANA O CORPORATION.

EIZO NANA O CORPORATION is under no obligation to hold any submitted material or information confidential unless prior arrangements are made pursuant to EIZO NANA O CORPORATION's receipt of said information.

Although every effort has been made to ensure that this manual provides up-to-date information, please note that EIZO monitor specifications are subject to change without notice.

VESA is a registered trademark or a trademark of the Video Electronics Standards Association in the United States and other countries. Windows, Windows Vista, Windows Media, SQL Server, and Xbox 360 are registered trademarks of Microsoft Corporation in the United States and other countries.

Apple, Mac, Macintosh, iMac, eMac, Mac OS, MacBook, PowerBook, ColorSync, QuickTime, and iBook are registered trademarks of Apple Inc.

EIZO, the EIZO Logo, ColorEdge, DuraVision, FlexScan, FORIS, RadiForce, RadiCS, RadiNET, Raptor, and ScreenManager are registered trademarks of EIZO NANA O CORPORATION in Japan and other countries.

ColorNavigator, EIZO EasyPIX, EcoView NET, EIZO ScreenSlicer, i • Sound, Screen Administrator, and UniColor Pro are trademarks of EIZO NANA O CORPORATION.

All other company and product names are trademarks or registered trademarks of their respective owners.

Notice for this monitor

This product is suited to general purposes like creating documents, viewing multimedia content.

This product has been adjusted specifically for use in the region to which it was originally shipped. If the product is used outside the region, it may not operate as specified in the specifications.

This product may not be covered by warranty for uses other than those described in this manual.

The specifications noted in this manual are only applicable when the following are used:

- Power cords provided with the product
 - Signal cables specified by us
-

Only use optional products manufactured or specified by us with this product.

As it takes about 30 minutes for the performance of electrical parts to stabilize, adjust the monitor 30 minutes or more after the monitor power has been turned on.

Monitors should be set to a lower brightness to reduce changes in luminosity caused by long-term use and maintain a stable display.

When the screen image is changed after displaying the same image for extended periods of time, an afterimage may appear. Use the screen saver or power save function to avoid displaying the same image for extended periods of time.

Periodic cleaning is recommended to keep the monitor looking new and to prolong its operation lifetime (refer to “Cleaning” on [page 27](#)).

The LCD panel is manufactured using high-precision technology. Although, missing pixels or lit pixels may appear on the LCD panel, this is not a malfunction. Percentage of effective dots: 99.9994% or higher.

The backlight of the LCD panel has a fixed lifetime. When the screen becomes dark or begins to flicker, please contact your dealer.

Do not press on the panel or edge of the frame strongly, as this may result in display malfunctions, such as interference patterns, etc. If pressure is continually applied to the panel, it may deteriorate or damage your panel. (If the pressure marks remain on the panel, leave the monitor with a black or white screen. The symptom may disappear.)

Do not scratch or press on the panel with any sharp objects, as this may result in damage to the panel. Do not attempt to brush with tissues as this may scratch the panel.

When the monitor is cold and brought into a room or the room temperature goes up quickly, dew condensation may occur on the interior and exterior surfaces of the monitor. In that case, do not turn the monitor on. Instead wait until the dew condensation disappears, otherwise it may cause some damage to the monitor.

To use the monitor comfortably

An excessively dark or bright screen may affect your eyes. Adjust the brightness of the monitor according to the environmental conditions.

Staring at the monitor for a long time tires your eyes. Take a 10-minute rest every hour.

CONTENTS

Notice for this monitor	1	2-6 Turning off the monitor automatically [Off Timer]	18
To use the monitor comfortably	1	2-7 Locking Buttons [Key Lock] [Menu Lock] ...	19
Chapter 1 Features and Overview	3	2-8 Displaying Monitor Information [Info1] [Info2].....	19
1-1 Features.....	3	2-9 Enabling/Disabling DDC/CI communication [DDC/CI]	19
1-2 Buttons and Indicators.....	4	2-10 Setting Power Indicator ON/OFF [Power LED]	20
1-3 Basic operation of Adjustment menu and the icon list.....	5	2-11 Setting Language [Language]	20
Chapter 2 Settings and Adjustments	8	2-12 Displaying EIZO logo.....	20
2-1 Utility Disk	8	2-13 Resuming the Default Setting [Reset]	21
• Disk contents and software overview	8	• To reset color adjustment values.....	21
• To use ScreenManager Pro for LCD	9	• To reset all adjustments to the factory default settings.....	21
2-2 Screen Adjustment	10	Chapter 3 Connecting Cables	22
Digital Input.....	10	3-1 Connecting Two PCs to the Monitor	22
Analog Input	10	• To switch the input signal	22
2-3 Color Adjustment.....	13	• Setting auto-selection of the input signal [Input Signal]	23
• To select the display mode (FineContrast mode)	13	Chapter 4 Troubleshooting.....	24
• To perform advanced adjustments	14	Chapter 5 Reference	26
• Adjustment items in each mode	14	5-1 Attaching an Arm	26
• To adjust the brightness [Brightness]	14	5-2 Power Saving Mode.....	27
• To adjust the contrast [Contrast].....	15	5-3 Cleaning.....	27
• To adjust the gamma value [Gamma].....	15	5-4 Specifications	28
• To adjust the color temperature [Temperature]	16	5-5 Glossary	33
• To adjust the gain value [Gain].....	16	5-6 Preset Timing	35
• To adjust the color saturation [Saturation].....	16		
• To adjust the hue [Hue]	17		
• To set Enable/Disable of the contrast enhancer [Cont Enhancer]	17		
2-4 Adjusting Sharpness [Sharpness].....	18		
2-5 Setting Enable/Disable for the automatic brightness adjustment function [Bright Reg]	18		

Chapter 1 Features and Overview

Thank you very much for choosing an EIZO color LCD monitor.

1-1 Features

- Over drive circuit for clear motion pictures
- Dual-input system (DVI-D, D-sub)
 - 3-1 “Connecting Two PCs to the Monitor” (page 22)
- BrightRegulator
 - 2-5 “Setting Enable/Disable for the automatic brightness adjustment function” (page 18)
- Contrast Enhancer
 - “To set Enable/Disable of the contrast enhancer” (page 17)
- Sharpness
 - 2-4 “Adjusting Sharpness” (page 18)
- Auto adjust
 - 2-2 “Screen Adjustment” (page 10)
- 11 bit gamma correction
 - “To adjust the gamma value” (page 15)
- Built-in speakers
 - “Adjusting Speaker Volume” (page 6) in the Setup Manual (supplied)
- FineContrast mode to allow the best mode for screen display.
 - 2-3 “Color Adjustment” (page 13)
- Adjustment menu to execute the target function by simple operation.
 - 1-3 “Basic operation of Adjustment menu and the icon list” (page 5)
- The utility software “ScreenManager Pro for LCD” (for Windows) to control the monitor from a PC with mouse/keyboard is included
 - Refer to “About ScreenManager Pro for LCD” on EIZO LCD Utility Disk.
- HDCP (High-bandwidth Digital Content Protection)
- DDC/CI (Display Data Channel Command Interface)
 - 2-9 “Enabling/Disabling DDC/CI communication” (page 19)

Note

- The stand of the unit can be replaced with an arm or another stand. (Refer to “5-1 Attaching an Arm” on page 26.)

1-2 Buttons and Indicators

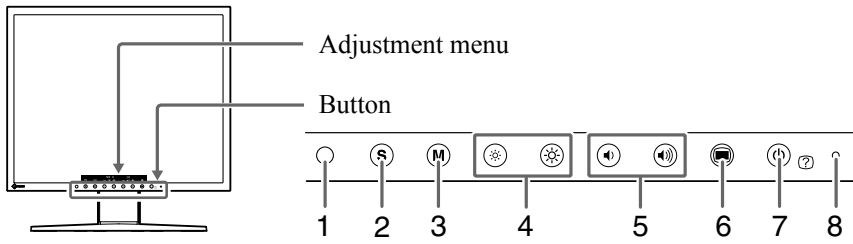

1. Sensor (BrightRegulator)
2. Input signal selection button
3. Mode button
4. Brightness control buttons
5. Volume control buttons
6. Menu button
7. Power/Help button
8. Power indicator

Indicator status	Operation status
Blue	The screen is displayed (Power on)
Orange	Power saving (Power on)
Off	Power off

Note

- While the screen is displayed, the power indicator that is lighting blue can be turned off (see “Setting Power Indicator ON/OFF” on [page 20](#)).

1-3 Basic operation of Adjustment menu and the icon list

Basic operation of Adjustment menu

Displaying the adjustment menu

Pressing the function button to change the setting or pressing  allows you to display the adjustment menu.

When pressing the input signal selection, mode, brightness control, or volume control button

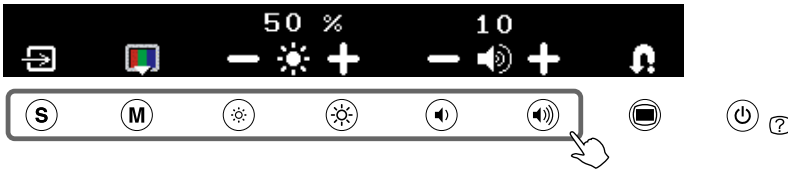

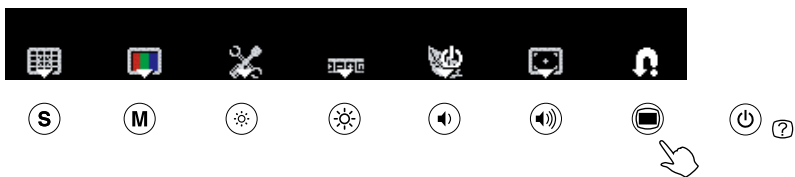

When pressing the menu button



Modifying the setting

The operation methods differ depending on the icons.

Example	Operation method
	As for the icons displayed with the +/- marks, selecting + allows you to increase the setting value or selecting - to decrease it.
	Selecting the icon displayed with ▽ mark allows you to show the next menu.
	The Enable/Disable setting is toggled by selecting the icon. X is displayed when the function is invalid.

Displaying the function name

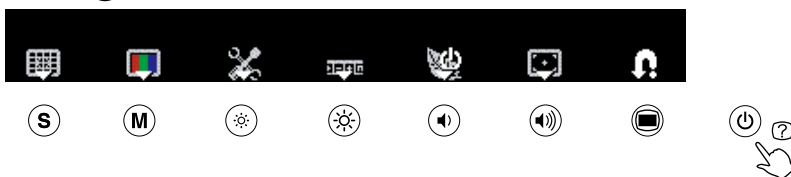

(1) Press  while the adjustment menu appears.

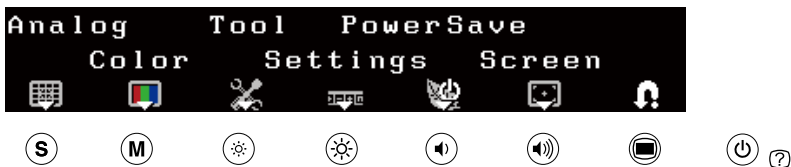

(2) The function name appears.



Storing the setting/Exiting the adjustment menu

After completing the setting, selecting  allows you to store the setting. Selecting  repeatedly allows you to close the adjustment menu.

Note









- The adjustment menu automatically finishes when no input operation occurs in 45 seconds.

Adjustment menu icon list

Icon	Function	Overview
	—	Determines the setting. Selecting the icon repeatedly allows you to close the adjustment menu.
	Analog	
	AutoSize	Flickering, screen position, and screen size are adjusted automatically. Returns to the pre-adjusted status. Determines the adjustment.
	AutoRange	Every color gradation (0 to 255) can be displayed by adjusting the signal output level. Returns to the pre-adjusted status. Determines the adjustment.
	Manual	Performs advanced adjustment when the automatic adjustment fails. The adjustments for clock, phase and position proceed in this order.
	Clock	Eliminates vertical bars.
	Phase	Removes flickering or blurring.
	Position	Correct screen position with .
	Color	
	Color Menu	Independent setting and saving of color adjustment are available for each FineContrast mode.
	Mode*	Selects the best display mode easily according to monitor's application. Each time you press the button, the mode is switched.
	Brightness	Adjusts the screen brightness. Adjustable range: 0 to 100%
	Contrast	Adjusts the contrast. Adjustable range: 0 to 100%
	Gain	Determines the mixing rate of red, green and blue, and adjust the color tone. Adjustable range: 0 to 100% Allows you to determine the mixing rate of red. Allows you to determine the mixing rate of green. Allows you to determine the mixing rate of blue.
	Advanced	Adjusts each function of hue, saturation and contrast enhancer.

* Current FineContrast mode is displayed.

Icon	Function	Overview
	Cont Enhancer	Reproduces images with a taste of contrast by compensating the gamma value as well as controlling the backlight brightness and the gain level according to the image status. The Enable/Disable setting is toggled by selecting the icon.
	Hue	Adjusts the hue. If you set the hue to a high value, the image turns greenish. If low, the image turns purplish. Adjustable range: -100 to 100
	Saturation	Adjusts the color saturation. Adjustable range: -100 to 100
	Temperature	Adjusts the color temperature. The gain preset values are set for each color temperature setting value. Adjustable range: Native, 4000K-10000K (specified by every 500K unit, including 9300K), User (at gain adjustment)
	Gamma	Adjusts the gamma value. Adjustable range: 1.8, 2.0, 2.2
	Tool	
	Info1	Displays the input signal status (analog/digital), resolution, H/V frequency.
	Info2	Displays the model name, usage time and serial number.
	Input Signal	Sets to detect the input signal automatically. The Enable/Disable setting is toggled by selecting the icon.
	DDC/CI	Sets enable/disable the DDC/CI communication. The Enable/Disable setting is toggled by selecting the icon.
	Reset	Resets the adjustment values to the factory settings. Attention <ul style="list-style-type: none"> After resetting, you cannot undo the operation. All : Resets all adjustments to the default settings (factory settings). Color (CUS*) : Only the adjustment values in the current FineContrast mode will revert to the default settings (factory settings).

Icon	Function	Overview
	Settings	
	Language	Selects a language for the adjustment menu or displaying message. The language setting is toggled by selecting the icon.
	PowerSave	
	Bright Reg	The sensor on the front side of the monitor detects the environmental brightness to adjust the screen brightness automatically and comfortably by using the BrightRegulator function. The Enable/Disable setting is toggled by selecting the icon.
	Power LED	Sets the power indicator (blue) ON/OFF in the monitor ON condition. The On/Off setting is toggled by selecting the icon.
	Off Timer	Turns off the monitor automatically after a specified time has passed. This function serves to protect the monitor from after-images caused when the same image is left displayed for a long time. Use this function when an image is displayed throughout the day. Adjustable range: Off, 1 to 23h
	Screen	
	Sharpness	Emphasizes the outline of the image by emphasizing the color difference between the pixels composing the image and to improve a sense of quality and materiality. Contrarily, this function allows you to show the image smoothly by blurring the outline of the image.

Chapter 2 Settings and Adjustments

2-1 Utility Disk

An “EIZO LCD Utility Disk” (CD-ROM) is supplied with the monitor. The following table shows the disk contents and the overview of the application software programs.

- **Disk contents and software overview**

The disk includes color profiles, application software programs for adjustment, and User’s Manual. Refer to “Readme.txt” or the “read me” file on the disk for software startup procedures or file access procedures.

Item	Overview	For Windows	For Macintosh
A “Readme.txt” or “read me” file		√	√
Color Profiles (ICC Profiles)	A specific file including the color characteristic information for the monitor. Used when performing the color management.	√	√
Screen Adjustment Utility	Monitor pattern display software used when adjusting the image of the analog input signal manually.	√	—
Screen adjustment pattern files	Used when adjusting the image of the analog signal input manually. If the Screen Adjustment Utility is not applicable to your PC, use this pattern files to adjust the image.	√	√
ScreenManager Pro for LCD	A utility software program to control monitor adjustments from a PC using its mouse and keyboard. (A PC must be connected to the monitor with the supplied USB cable.) Refer to the description later.	√	—
WindowMovie Checker Software	WindowMovie is a function of ScreenManager Pro for LCD. For more information, refer to the User’s Manual of ScreenManager Pro for LCD on the disk.		
User’s Manual of this monitor (PDF file)			

- **To use ScreenManager Pro for LCD**

For the installation and use of ScreenManager Pro for LCD, refer to its User's Manual on the disk.

To adjust the monitor using ScreenManager Pro for LCD, connect a PC to the monitor with the supplied USB cable.

[Connection]

- (1) Connect the USB port (downstream) of a USB compatible PC (or other USB hub) and the monitor's USB port (upstream) with the supplied USB cable.
- (2) The USB function is set up automatically upon connection of the USB cable.

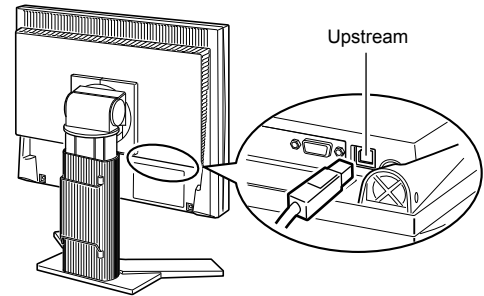

2-2 Screen Adjustment

Digital Input

When digital signals are input, images are displayed correctly based on the preset data of the monitor. When performing the advanced adjustment, see “2-3 Color Adjustment” (page 13) and its subsequence pages.

Analog Input

The monitor screen adjustment is used to suppress flickering of the screen or adjust screen position and screen size correctly according to the PC to be used. To use the monitor comfortably, adjust the screen when the monitor is set up for the first time or when the settings of the PC in use are updated. No adjustment is required when the image appears correctly.

The auto adjust function works in the following cases:

- When a signal is input into the monitor for the first time
- When the resolution or Vertical/Horizontal Frequency of input signals is changed

[Adjustment Procedure]

1 Perform the AutoSize adjustment.

- To adjust flickering, screen position, and screen size automatically [AutoSize]

(1) Press .

The adjustment menu appears.

(2) Select  (Analog).

(3) Select  (AutoSize).

Flickering, screen position, and screen size are adjusted automatically.

(4) After confirming the screen message, select  (OK).

If you select  (Undo), the monitor returns to the pre-adjusted status.

2 Prepare the display pattern for the analog display adjustment.

(1) Load the “EIZO LCD Utility Disk” to your PC.

(2) For Windows PC: Start the “Screen Adjustment Utility” from the startup menu on the disk.

For other than Windows PC: Use the screen adjustment pattern files.

If the screen is not displayed correctly even after adjusting in step 1 above, perform the adjustments according to the procedures on the following pages. When the screen is displayed correctly, go to step 5 “To adjust color gradation automatically [AutoRange]”.

Attention

- Wait 30 minutes or more from monitor power on before starting adjustments.
- Auto adjust function does not work for the images under the resolution of 800 × 600 (SVGA).

Attention

- This function works correctly when an image is fully displayed over the Windows or Macintosh display area. It does not work properly when an image is displayed only on a part of the screen (command prompt window, for example) or when a black background (wallpaper, etc.) is in use.
- This function does not work correctly with some graphics boards.
- “Auto in Progress” appears on the screen during auto adjustment.

Note

- For how to open and use the screen adjustment pattern files, refer to “Readme.txt” or the “read me” file. When you are using a Macintosh PC, you can open the file directly from the start menu of the disk.

3 Perform the AutoSize adjustment again with the analog screen adjustment pattern displayed.

- **To adjust flickering, screen position, and screen size automatically [AutoSize]**

(1) Display Pattern 1 in full screen on the monitor using the “Screen Adjustment Utility” or the screen adjustment pattern files.

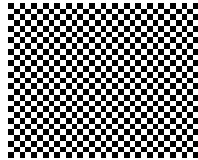

(2) Press .

The adjustment menu appears.

(3) Select  (Analog).

(4) Select  (AutoSize).

Flickering, screen position, and screen size are adjusted automatically.

(5) After confirming the screen message, select  (OK).



If you select  (Undo), the monitor returns to the pre-adjusted status.

If the screen is not displayed correctly even after adjusting in step 3 above, perform the adjustments according to the procedures on the following pages. When the screen is displayed correctly, go to step 5 “To adjust color gradation automatically [AutoRange]”.

4 Perform advanced adjustments by using (Manual) in the adjustment menu.



Select  (Manual) to adjust the clock, phase and position, in this order.

- **To eliminate vertical bars [Clock]**

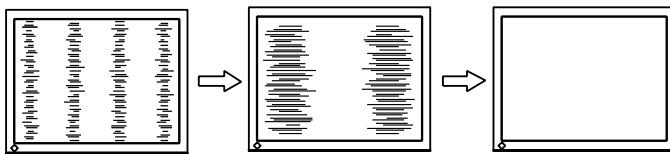
(1) Adjust the clock with  or  of  (Clock) to eliminate vertical bars.



- **To remove flickering or blurring [Phase]**

(1) Adjust the phase with  or  of  (Phase) to remove flickering or blurring.

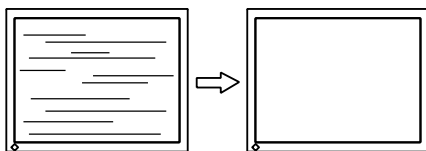







Note

- Press the control button slowly so as not to miss the adjustment point.
- When blurring, flickering or bars appear on the screen after adjustment, proceed to [Phase] to remove flickering or blurring.

Attention

- Flickering or blurring may not be eliminated depending on your PC or graphics board.

- **To correct screen position [Position]**

- (1) Select  (Position).
 - (2) Adjust the position with  (Left) /  (Right) /  (Down) /  (Up) to display the image properly in the display area of the monitor.
 - (3) Select .
- The adjustment is completed.

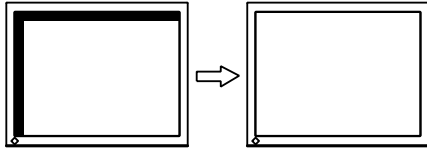





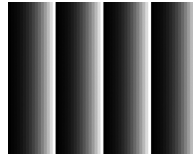

5 Adjust the color gradation.

- **To adjust color gradation automatically [AutoRange]**

Every color gradation (0 to 255) can be displayed by adjusting the signal output level.

- (1) Display Pattern 2 in full screen on the monitor using the “Screen Adjustment Utility” or the screen adjustment pattern files.



- (2) Press .
- The adjustment menu appears.
- (3) Select  (Analog).
 - (4) Select  (AutoRange).
- Color gradation is adjusted automatically.
- (5) After confirming the screen message, select  (OK).
- If you select  (Undo), the monitor returns to the pre-adjusted status.
- (6) Close the Pattern 2. When using the “Screen Adjustment Utility”, close the program.

Note







- Since the number of pixels and the pixel positions are fixed on the LCD monitor, only one position is provided to display images correctly. The position adjustment is made to shift an image to the correct position.
- When vertical bars appear on the screen after adjustment, go back to “To eliminate vertical bars [Clock]”. (Clock → Phase → Position)



2-3 Color Adjustment

- **To select the display mode (FineContrast mode)**



FineContrast allows you to select the best display mode easily according to the monitor's application.

FineContrast mode

Mode	Purpose
 (CUS)	Custom mode. Available to change all setting values.
 (sRGB)	sRGB mode. Suitable for color matching with sRGB compatible peripherals.
 (TXT)	Text mode. Suitable for displaying texts for word processing or spreadsheets.
 (PIC)	Picture mode. Suitable for displaying images such as photos or picture images.
 (MOV)	Movie mode. Suitable for playing back animated images.
 (CAD)	CAD mode. Suitable for displaying CAD drawings.

- (1) Press .
The adjustment menu appears.
- (2) Press  again while the adjustment menu is displayed.
Each time you press the button, the mode is switched.
- (3) Select .
The mode selected is set.

Note

- You can also select the FineContrast mode by pressing  and select  (Color).
- “ScreenManager Pro for LCD” allows you to select the FineContrast mode automatically according to the application used.
(Refer to “Chapter 3 Auto FineContrast” on the User’s Manual for “ScreenManager Pro for LCD”.)

- **To perform advanced adjustments**

Independent setting and saving of color adjustment are available for each FineContrast mode.

- **Adjustment items in each mode**

According to the FineContrast mode selected, the adjustable function differs.

√: Adjustment available —: Invalid for adjustment

Icon	Function	FineContrast mode					
		CUS	sRGB	TXT	PIC	MOV	CAD
	Brightness	√	√	√	√	√	√
	Contrast	√	—	√	√	√	√
	Gamma	√	—	√	—	—	—
	Temperature	√	—	√	√	√	√
	Gain	√	—	—	—	—	—
	Saturation	√	—	—	√	√	—
	Hue	√	—	—	√	√	—
	Cont Enhancer	√	—	—	—	—	—

- **To adjust the brightness [Brightness]**

The screen brightness is adjusted by changing the brightness of the backlight (Light source from the LCD back panel).

Adjustable range: 0 to 100%

- (1) Press .
The adjustment menu appears.
- (2) Select (Color).
- (3) Adjust the brightness with or of (Brightness).
- (4) Select .
The adjustment is completed.

Attention

- Wait 30 minutes or more from monitor power on before starting the color adjustment.
- Perform (AutoRange) first when adjusting color for analog input signals.
(Refer to “To adjust color gradation automatically” on page 12).
- The same image may be seen in different colors on multiple monitors due to their monitor-specific characteristics. Make fine color adjustment visually when matching colors on multiple monitors.

Note

- The values shown in “%” or “K” are available only as reference.
- Using the “ScreenManager Pro for LCD” allows you to perform the color adjustment by using the mouse and keyboard of your PC. The adjusted status can be registered as a color data and restore the data later. (Refer to “Chapter 4 Color Adjustment” on the User’s Manual for “ScreenManager Pro for LCD”.)

Note

- You can also adjust the brightness by pressing or without displaying the adjustment menu.

• To adjust the contrast [Contrast]

The luminance of the screen is adjusted by varying the video signal level.

Adjustable range: 0 to 100%

- (1) Press .

The adjustment menu appears.

- (2) Select  (Color).

- (3) Adjust the contrast with  or  of  (Contrast).

- (4) Select .

The adjustment is completed.

• To adjust the gamma value [Gamma]

The gamma value can be adjusted. The luminance of the monitor varies depending on the input signal, however, the variation rate is not proportional to the input signal. To keep the balance between the input signal and the luminance of the monitor is called as “Gamma correction”.



Adjustable range: 1.8, 2.0, 2.2

- (1) Press .

The adjustment menu appears.

- (2) Select  (Color).





- (3) Select  (Color Menu).

- (4) Adjust the gamma value with  or  of  (Gamma).

- (5) Select .

The adjustment is completed.

Note

- You can also adjust the contrast by pressing  while the adjustment menu is not displayed, and press  or  of  (Contrast).
- In the contrast of 50%, every color gradation is displayed.
- When adjusting the monitor, it is recommended to perform the brightness adjustment which may not lose the gradation characteristics, prior to the contrast adjustment. Perform the contrast adjustment in the following cases.
 - When you feel the image is dark even if the brightness is set to 100%.
 - When you feel the black level of the screen is bright (Set the brightness down and the contrast to higher than 50%).

Note

- You cannot adjust the value if the icon is not displayed, depending on the FineContrast mode selected. (See “Adjustment items in each mode” on [page 14.](#))

● To adjust the color temperature [Temperature]

The color temperature can be adjusted. The color temperature is normally used to express the hue of “White” and/or “Black” by a numerical value. The value is expressed in degrees “K” (Kelvin).

In the same way as the flame temperature, the image on the monitor is displayed reddish if the color temperature is low and is bluish if the color temperature is high. The gain preset values are set for each color temperature setting value.

5000K	The white color image is displayed reddish. The 5000K or 6000K is usually used in the printing industry.
6500K	The white color image is displayed in warm white like paper white. The temperature is suitable to display photographs or video images.
9300K	The white color image is displayed slightly bluish white.



Adjustable range: Native, 4000K-10000K (specified by every 500K unit, including 9300K), User (at gain adjustment)

(1) Press .

The adjustment menu appears.

(2) Select  (Color).

(3) Select  (Color Menu).

(4) Adjust the color temperature with  or  of  (Temperature).

(5) Select .

The adjustment is completed.

● To adjust the gain value [Gain]

Each luminance of red/green/blue composing the color is called “Gain”. The gain adjustment may change the color tone of the “White” (when the max input signal for each color is obtained)

Adjustable range: 0 to 100%

(1) Press .



The adjustment menu appears.

(2) Select  (Color).

(3) Select  (Color Menu).

(4) Select  (Gain).

(5) Adjust the respective value of  (Red)/ (Green)/ (Blue) with

 or .

(6) Select .

The adjustment is completed.

● To adjust the color saturation [Saturation]

This function allows you to adjust the saturation of the color on the monitor.

Adjustable range: -100 to 100

(1) Press .

The adjustment menu appears.

(2) Select  (Color).

(3) Select  (Color Menu).

(4) Select  (Advanced).

(5) Adjust the saturation with  or  of  (Saturation).

(6) Select .

The adjustment is completed.

Note

- You cannot adjust the value if the icon is not displayed, depending on the FineContrast mode selected. (See “Adjustment items in each mode” on [page 14](#).)
- [Gain] allows you to perform more advanced adjustment (See “To adjust the gain value” on [page 16](#)).
- If you set to [Native], the image is displayed in the preset color of the monitor (Gain: 100% for each RGB).
- When changing the gain value, the color temperature adjusting range is changed to “User”.

Note

- You cannot adjust the value if the icon is not displayed, depending on the FineContrast mode selected. (See “Adjustment items in each mode” on [page 14](#).)
- The gain value may change depending on the value of the color temperature.
- When changing the gain value, the color temperature adjusting range is changed to “User”.

Attention

- This function does not enable to display every color gradation.









Note

- You cannot adjust the value if the icon is not displayed, depending on the FineContrast mode selected. (See “Adjustment items in each mode” on [page 14](#).)
- Setting the minimum (-100) turns the image to a monochrome screen.

• To adjust the hue [Hue]





This function allows you to adjust the hue. If you set the hue to a high value, the image turns greenish. If low, the image turns purplish.



Adjustable range: -100 to 100

- (1) Press .
The adjustment menu appears.
- (2) Select  (Color).
- (3) Select  (Color Menu).
- (4) Select  (Advanced).
- (5) Adjust the hue with  or  of  (Hue).
- (6) Select .
The adjustment is completed.

• To set Enable/Disable of the contrast enhancer [Cont Enhancer]

This function allows you to reproduce images with a taste of contrast by compensating the gamma value as well as controlling the backlight brightness and the gain level according to the image status.

- (1) Press .
The adjustment menu appears.
- (2) Select  (Color).
- (3) Select  (Color Menu).
- (4) Select  (Advanced).
- (5) The Enable/Disable setting is toggled by selecting  (Cont Enhancer).

	Enable
	Disable

- (6) Select .
The mode selected is set.

Attention

- This function does not enable to display every color gradation.

Note

- You cannot adjust the value if the icon is not displayed, depending on the FineContrast mode selected. (See “Adjustment items in each mode” on [page 14.](#))







Note

- You cannot adjust the value if the icon is not displayed, depending on the FineContrast mode selected. (See “Adjustment items in each mode” on [page 14.](#))

2-4 Adjusting Sharpness [Sharpness]



This function allows you to emphasize the outline of the image by emphasizing the color difference between the pixels composing the image and to improve a sense of quality and materiality. Contrarily, this function allows you to show the image smoothly by blurring the outline of the image.



Adjustable range: -3 to 3

- (1) Press .
The adjustment menu appears.
- (2) Select  (Screen).
- (3) Adjust the sharpness with  or  of  (Sharpness).
- (4) Select .
The adjustment is completed.

2-5 Setting Enable/Disable for the automatic brightness adjustment function [Bright Reg]

The sensor on the front side of the monitor detects the environmental brightness to adjust the screen brightness automatically and comfortably by using the BrightRegulator function.

- (1) Press .
The adjustment menu appears.
- (2) Select  (PowerSave).
- (3) The Enable/Disable setting is toggled by selecting  (Bright Reg).







	Enable
	Disable

- (4) Select .
The mode selected is set.

2-6 Turning off the monitor automatically [Off Timer]

This function allows the monitor to automatically turn off after a specified time has passed. This function serves to protect the monitor from after-images caused when the same image is left displayed for a long time. Use this function when an image is displayed throughout the day.

Adjustable range: Off, 1 to 23h

- (1) Press .
The adjustment menu appears.
- (2) Select  (PowerSave).
- (3) Set a monitor OFF time with  or  of  (Off Timer).
Select "Off" to set Off timer setting to "Off".
- (4) Select .
The Off timer setting is completed.
- (5) "Power will shut off in a minute" appears on the display if it becomes one minute before the setting time.
If you select  (Extend), the off timer function works 90 minutes later.

Note





- You can turn on or off the monitor at the setting time by using the "ScreenManager Pro for LCD". You can specify up to 8 timer settings.



2-7 Locking Buttons [Key Lock] [Menu Lock]

This function allows you to lock the operation buttons to prevent changing the adjusted/set status.

Key Lock : Locks the buttons other than the Power button.

Menu Lock : Locks the buttons other than the Power, Input signal selection, Brightness control, and Volume control buttons.

- (1) Press  to turn off the monitor.
- (2) Press  holding  down to turn on the monitor.
The adjustment menu appears.
- (3) Each time you press , the mode is switched.

	Unlock
	Menu Lock
	Key Lock





- (4) Select .
The mode selected is set.

2-8 Displaying Monitor Information [Info1] [Info2]

This function allows you to display the input signal status, current resolution and model name.



Info1 : Displays the input signal status (analog/digital), resolution, H/V frequency



Info2 : Displays the model name, usage time and serial number.

- (1) Press .
The adjustment menu appears.
- (2) Select  (Tool).
- (3) Select  (Info1) or  (Info2).
- (4) Select .
The menu is closed.

2-9 Enabling/Disabling DDC/CI communication [DDC/CI]

This function allows you to enable/disable the DDC/CI communication.



- (1) Press .
The adjustment menu appears.
- (2) Select  (Tool).
- (3) The Enable/Disable setting is toggled by selecting  (DDC/CI).



	Enable
	Disable

- (4) Select .
The mode selected is set.

2-10 Setting Power Indicator ON/OFF [Power LED]

This function allows you to set the power indicator (blue) ON/OFF in the monitor ON condition.

- (1) Press .
The adjustment menu appears.
- (2) Select  (PowerSave).
- (3) The On/Off setting is toggled by selecting  (Power LED).

	On
	Off



- (4) Select .
The mode selected is set.

2-11 Setting Language [Language]

This function allows you to select a language for the adjustment menu or displaying message.

Selectable languages

English/German/French/Spanish/Italian/Swedish/Simplified Chinese/
Traditional Chinese/Japanese



- (1) Press .
The adjustment menu appears.
- (2) Select  (Settings).
- (3) The language setting is toggled by selecting  (Language).

	English
	German
	French
	Spanish
	Italian
	Swedish
	Simplified Chinese
	Traditional Chinese
	Japanese

- (4) Select .
The language selected is set.

2-12 Displaying EIZO logo

The EIZO logo appears on the display when turning on the monitor. This function allows you to display, or not, the EIZO logo.

- (1) Press  to turn off the monitor.
- (2) Press  holding  down to turn on the monitor.
The EIZO logo display setting is toggled by performing the operation in step 2.

2-13 Resuming the Default Setting [Reset]

There are two types of Reset. One is to reset the color adjustment only to the default settings, and the other is to reset all the settings to the default settings.

• To reset color adjustment values

Only the adjustment values in the current FineContrast mode will revert to the default settings (factory settings).

(1) Press .

The adjustment menu appears.

(2) Select  (Tool).

(3) Select  (Reset).

If you will not perform the reset operation, select .

(4) Select  (Color (CUS*)).

The color adjustment values revert to the default settings.

* Current FineContrast mode is displayed.

• To reset all adjustments to the factory default settings

Reset all adjustments to the factory default settings.

(1) Press .

The adjustment menu appears.

(2) Select  (Tool).

(3) Select  (Reset).

If you will not perform the reset operation, select .

(4) Select  (All).

All setting values revert to the default settings.

Attention

- After resetting, you cannot undo the operation.

Chapter 3 Connecting Cables

3-1 Connecting Two PCs to the Monitor

Two PCs can be connected to the monitor through the DVI-D and the D-Sub mini 15 pin connector on the back of the monitor.

Connection examples

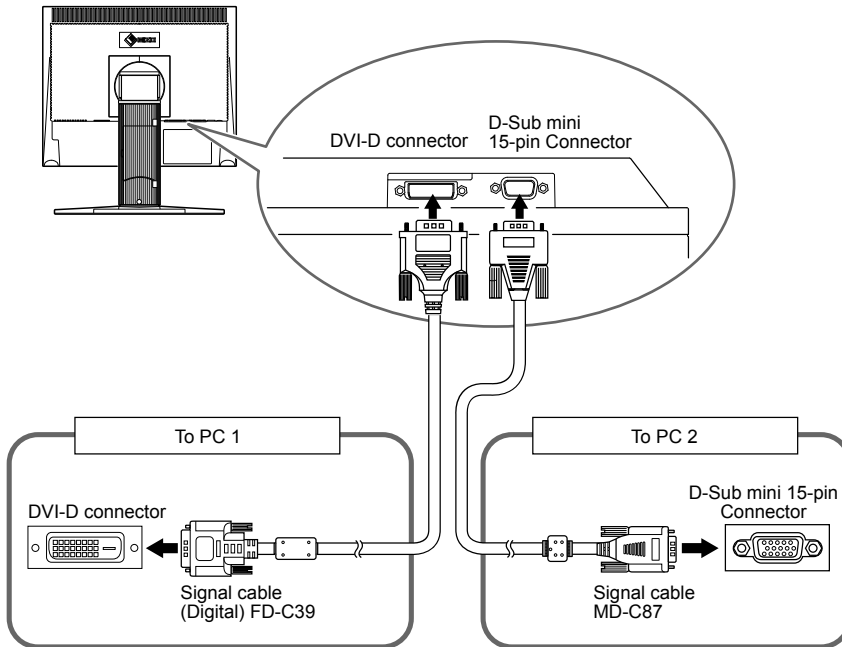

- **To switch the input signal**

The input signal switches each time **(S)** is pressed.

When the signal is switched, the active input port name appears at the top right corner of the screen.

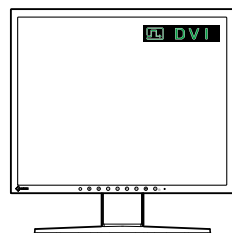

- **Setting auto-selection of the input signal [Input Signal]**

Enable : When either PC is turned off or enters the power-saving mode, the monitor automatically displays signals of another PC.



Disable: The monitor does not detect the PC's signals automatically. Switch an input signal with .

(1) Press .

The adjustment menu appears.

(2) Select  (Tool).

(3) The Enable/Disable setting is toggled by selecting  (Input Signal).

	Enable
	Disable

(4) Select .

The mode selected is set.





Note



- When “Enable” is selected for [Input Signal], the monitor’s power-saving function works only when the two PCs are in the power-saving mode.

Chapter 4 Troubleshooting

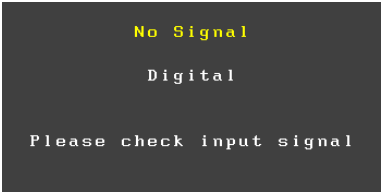
If a problem still remains after applying the suggested remedies, contact your local dealer.

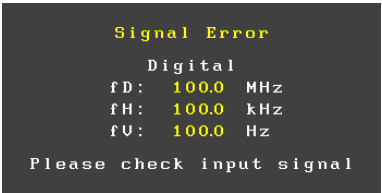
- No-picture problems → See No.1 - No.2.
- Imaging problems (digital input) → See No.3 - No.9.
- Imaging problems (analog input) → See No.3 - No.12.
- Other problems → See No.13 - No.15.
- USB problems → See No.16.

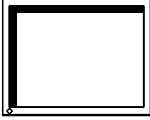
Problems	Possible cause and remedy
1. No picture <ul style="list-style-type: none"> • Power indicator does not light. 	<ul style="list-style-type: none"> • Check whether the power cord is connected correctly. If the problem persists, turn off the monitor, and then turn it on again a few minutes later. • Press .
<ul style="list-style-type: none"> • Power indicator is lighting blue. 	<ul style="list-style-type: none"> • Set each RGB adjusting value in [Gain] to higher level. (see page 16)
<ul style="list-style-type: none"> • Power indicator is lighting orange. 	<ul style="list-style-type: none"> • Switch the input signal with . • Operate the mouse or keyboard. • Check whether the PC is turned on.
2. The message below appears. <ul style="list-style-type: none"> • This message appears when no signal is input. 	<p>This message appears when the signal is not input correctly even when the monitor functions properly.</p> <ul style="list-style-type: none"> • The message shown left may appear, because some PCs do not output the signal soon after power-on. • Check whether the PC is turned on. • Check whether the signal cable is connected properly. • Switch the input signal with .
<ul style="list-style-type: none"> • The message shows that the input signal is out of the specified frequency range. (Such signal frequency is displayed in yellow.) Example: 	<ul style="list-style-type: none"> • Check whether the signal setting of your PC matches the resolution and the vertical frequency settings for the monitor. (See “Compatible Resolutions/Frequencies” on the cover back of the Setup Manual.) • Reboot the PC. • Select an appropriate display mode using the graphics board’s utility. Refer to the manual of the graphics board for details. <ul style="list-style-type: none"> fD : Dot Clock (Displayed only when the digital signal inputs) fH : Horizontal Frequency fV : Vertical Frequency
3. The screen is too bright or too dark.	<ul style="list-style-type: none"> • Adjust using [Brightness] or [Contrast]. (The LCD monitor backlight has a fixed life span. When the screen becomes dark or begins to flicker, contact your local dealer.)
4. Characters are blurred.	<ul style="list-style-type: none"> • Check whether the signal setting of your PC matches the resolution and the vertical frequency settings for the monitor. (See “Compatible Resolutions/Frequencies” on the cover back of the Setup Manual.) • Adjust using [Sharpness]. (see page 18)
5. Afterimages appear.	<ul style="list-style-type: none"> • Use a screen saver or off timer function for a long-time image display. • Afterimages are particular to LCD monitors. Avoid displaying the same image for a long time.
6. Green/red/blue/white dots or defective dots remain on the screen.	<ul style="list-style-type: none"> • This is due to LCD panel characteristics and is not a failure.

Problems	Possible cause and remedy
7. Interference patterns or pressure marks remain on the screen.	<ul style="list-style-type: none"> • Leave the monitor with a white or black screen. The symptom may disappear.
8. The outline of the letters are colored.	<ul style="list-style-type: none"> • If the [Sharpness] setting is set to a high level, the characters displayed on the monitor may be colored.
9. Noise appears on the screen.	<ul style="list-style-type: none"> • When entering the signals of HDCP system, the normal images may not be displayed immediately.
10. Display position is incorrect. 	<ul style="list-style-type: none"> • Adjust image position so that it is displayed properly within the display area using [Position]. (See page 12) • If the problem persists, use the graphics board's utility if available to change the display position.
11. Vertical bars appear on the screen or a part of the image is flickering. 	<ul style="list-style-type: none"> • Adjust using [Clock]. (see page 11)
12. Whole screen is flickering or blurring. 	<ul style="list-style-type: none"> • Adjust using [Phase]. (see page 11)
13. The adjustment menu does not appear.	<ul style="list-style-type: none"> • Check whether the operation lock function works. (see page 19)
14. The auto adjust function does not work correctly.	<ul style="list-style-type: none"> • This function does not work when digital signal is input. • Check whether the operation lock function works. (see page 19) • This function does not work correctly with some graphics boards.
15. No audio output.	<ul style="list-style-type: none"> • Check whether the mini jack cable is correctly connected. • Check whether volume is set to 0. • Check the setting of the PC and the audio playback software.
16. The monitor connected with the USB cable is not detected.	<ul style="list-style-type: none"> • Check whether the USB cable is connected correctly. • Please perform the following to check the status. <ul style="list-style-type: none"> • Reboot the PC. • Check whether the PC and OS are USB compliant. (For USB compliance of the respective devices, consult their manufacturers.) • Check the PC's BIOS setting for USB when using Windows. (Refer to the manual of the PC for details.)

Chapter 5 Reference

5-1 Attaching an Arm

The stand can be removed and replaced with an arm (or another stand) to be attached to the monitor. Use an arm or stand of EIZO option.

[Attaching]

1 Lay the LCD monitor on a soft cloth spread over on a stable surface with the panel surface facing down.

2 Remove the stand. (Prepare a screwdriver.)

Unscrew the four screws securing the unit and the stand with the screwdriver.

3 Attach the monitor to the arm or stand.

Secure the monitor to the arm or stand using the screws specified in the user's manual of the arm or stand.

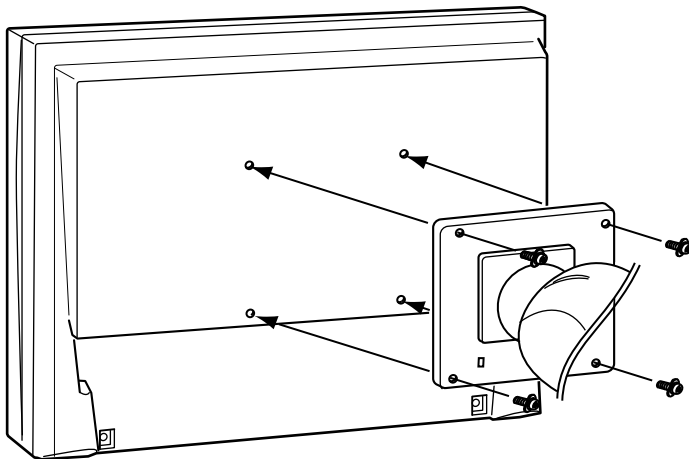

Attention

- When attaching an arm or stand, follow the instructions of their user's manual.
- When using another manufacturer's arm or stand, confirm the following in advance and select one conforming to the VESA standard. Use the M4 × 12 mm screws supplied with this monitor.
 - Clearance between the screw holes: 100 mm × 100 mm
 - Thickness of plate: 2.6 mm
 - Strong enough to support weight of the monitor unit (except the stand) and attachments such as cables.
- When using an arm or stand, attach it to meet the following tilt angles of the monitor.
 - Up 45 degrees, down 45 degrees (horizontal display, and vertical display rotated 90 degrees clockwise)
- Connect the cables after attaching an arm.
- If you need to remove the EZ-UP stand, turn the panel on the monitor to the left and right a little to appear the four screws positioned under the stand. Then unscrew the four screws.

5-2 Power Saving Mode

■ Analog input

This monitor complies with the VESA DPMS standard.

[Power Saving System]

PC		Monitor	Power Indicator
Operating		Operating	Blue
Power saving	STAND-BY SUSPENDED OFF	Power saving	Orange

[Resumption Procedure]

- Operate the mouse or keyboard to resume the normal screen.

■ Digital input

This monitor complies with the DVI DMPM standard.

[Power Saving System]

The monitor enters the power saving mode in five seconds in connection with the PC setting.

PC	Monitor	Power Indicator
Operating	Operating	Blue
Power saving	Power saving	Orange

[Resumption Procedure]

- Operate the mouse or keyboard to resume the normal screen.

5-3 Cleaning

If necessary, the stains on the cabinet and panel surface can be removed by moistening part of a soft cloth with water.

Attention

- Unplugging the power cord completely shuts off power supply to the monitor.
- Power consumption changes even when a sound input signal is detected.

Attention

- Chemicals such as alcohol and antiseptic solution may cause gloss variation, tarnishing, and fading of the cabinet or panel, and also quality deterioration of the image.
- Never use any thinner, benzene, wax, and abrasive cleaner, which may damage the cabinet or panel.

Note





- The optional ScreenCleaner is recommended for cleaning the cabinet and panel surface.

5-4 Specifications

LCD Panel		19-inch (480 mm) TFT color LCD with anti-glare Viewing angle: Horizontal 178°, Vertical 178° (CR:10 or more)
Dot Pitch		0.294mm
Horizontal Scan Frequency		Analog: 24.8-80kHz Digital: 31-64kHz
Vertical Scan Frequency		Analog: 50-75Hz (Non-interlace) Digital: 59-61Hz (Non-interlace) (VGA TEXT: 69-71Hz)
Resolution		1280 dots × 1024 lines
Max. Dot Clock		Analog: 135MHz Digital: 108MHz
Max. Display Color		Approx. 16.77 million colors
Display Area (H × V)		376.3mm × 301.0mm
Power Supply		100-120 VAC ±10%, 50/60Hz 0.65A 200-240 VAC ±10%, 50/60Hz 0.4A
Power Consumption	Screen Display On	45W or less (Speaker working) 40W or less (Speaker not working)
	Power saving mode	0.8W or less (for single signal input, when stereo mini jack cable is not connected)
	Power button Off	0.7W or less
Input Signal Connector		DVI-D connector (Applicable to HDCP), D-Sub mini 15-pin
Analog Input Signal (Sync)		Separate, TTL, positive/ negative
Analog Input Signal (Video)		Analog, Positive (0.7Vp-p/75Ω)
Digital Signal Transmission System		TMDS (Single Link)
Video Signal Memory		Analog signal: 26 (preset: 21)
Audio Output		Speaker output: 0.5W + 0.5W (8Ω, THD: 10% or less) Headphone output: 2mW + 2mW
Line input		Input impedance : 48 kΩ (typ.) Input level : 1.0 Vrms (Max.)
Plug & Play		VESA DDC 2B / EDID structure 1.3
Dimensions (Width) × (Height) × (Depth)	Main unit (including Tilt stand)	405 mm (15.9 inch) × 416 mm (16.4 inch) × 205 mm (8.1 inch)
	Main unit (including Height adjustable stand)	405 mm (15.9 inch) × 406.5 - 506.5 mm (16.0 - 19.9 inch) × 205 mm (8.1 inch)
	Main unit (including ArcSwing2 stand)	405 mm (15.9 inch) × 288 - 423.5 mm (11.3 - 16.7 inch) × 200 mm (7.9 inch)
	Main unit (including EZ-UP stand)	405 mm (15.9 inch) × 347.7 - 507 mm (13.7 - 20.0 inch) × 246.8 - 277.6 mm (9.7 - 10.9 inch)
	Main unit (without stand)	405 mm (15.9 inch) × 334 mm (13.1 inch) × 61.5 mm (2.4 inch)

Mass	Main unit (including Tilt stand)	6.0 kg (13.2 lbs.)
	Main unit (including Height adjustable stand)	7.2 kg (15.9 lbs.)
	Main unit (including ArcSwing2 stand)	7.0 kg (15.4 lbs.)
	Main unit (including EZ-UP stand)	8.8 kg (19.4 lbs.)
	Main unit (without stand)	5.2 kg (11.5 lbs.)
Movable range	Tilt stand	Tilt: 30° Up, 5° Down
	Height adjustable stand	Tilt: 30° Up, 0° Down Swivel: 35° Right, 35° Left Adjustable height: 100 mm (3.9 inch) Rotation: 90° (clockwise)
	ArcSwing2 stand	Tilt: 60° Up, 5° Down Swivel: 172° Right, 172° Left Adjustable height: 134.5 mm (5.3 inch)
	EZ-UP stand	Tilt: 25° Up, 0° Down Swivel: 172° Right, 172° Left Adjustable height: 159.3 mm (6.3 inch) Rotation: -10° to 92° (clockwise)
Environmental Conditions	Temperature	Operating temperature: 0 °C - 35 °C (32 °F - 95 °F) Storage temperature: -20 °C - 60 °C (-4 °F - 140 °F)
	Humidity	Relative humidity: 30% - 80% (no condensation)
USB	Standard	USB Specification Revision 2.0
	Port	Upstream port × 1

Main default settings (factory settings)

BrightRegulator	 Disable
FineContrast Mode	 Custom
Off Timer	 Disable
Language	 English

Outside Dimensions (Tilt stand)

unit : mm (inch)

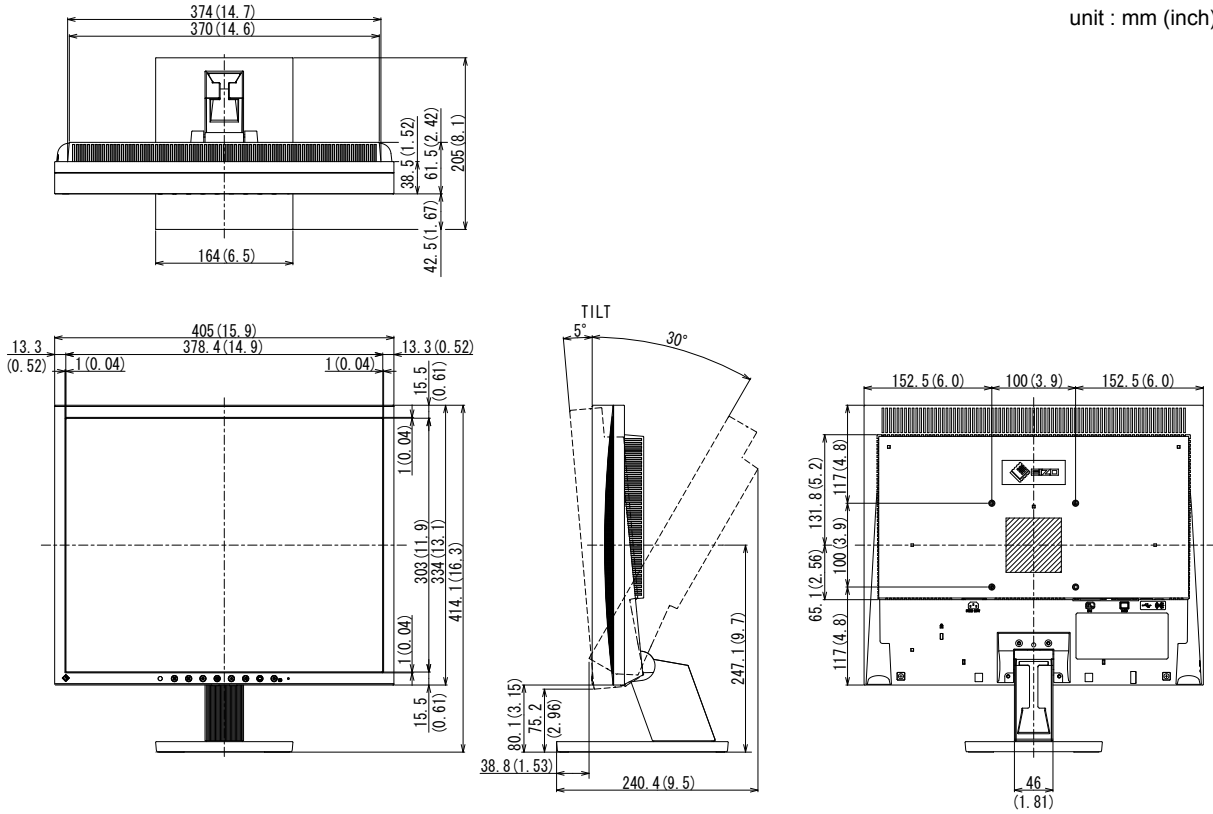

Outside Dimensions (Height adjustable stand)

unit : mm (inch)

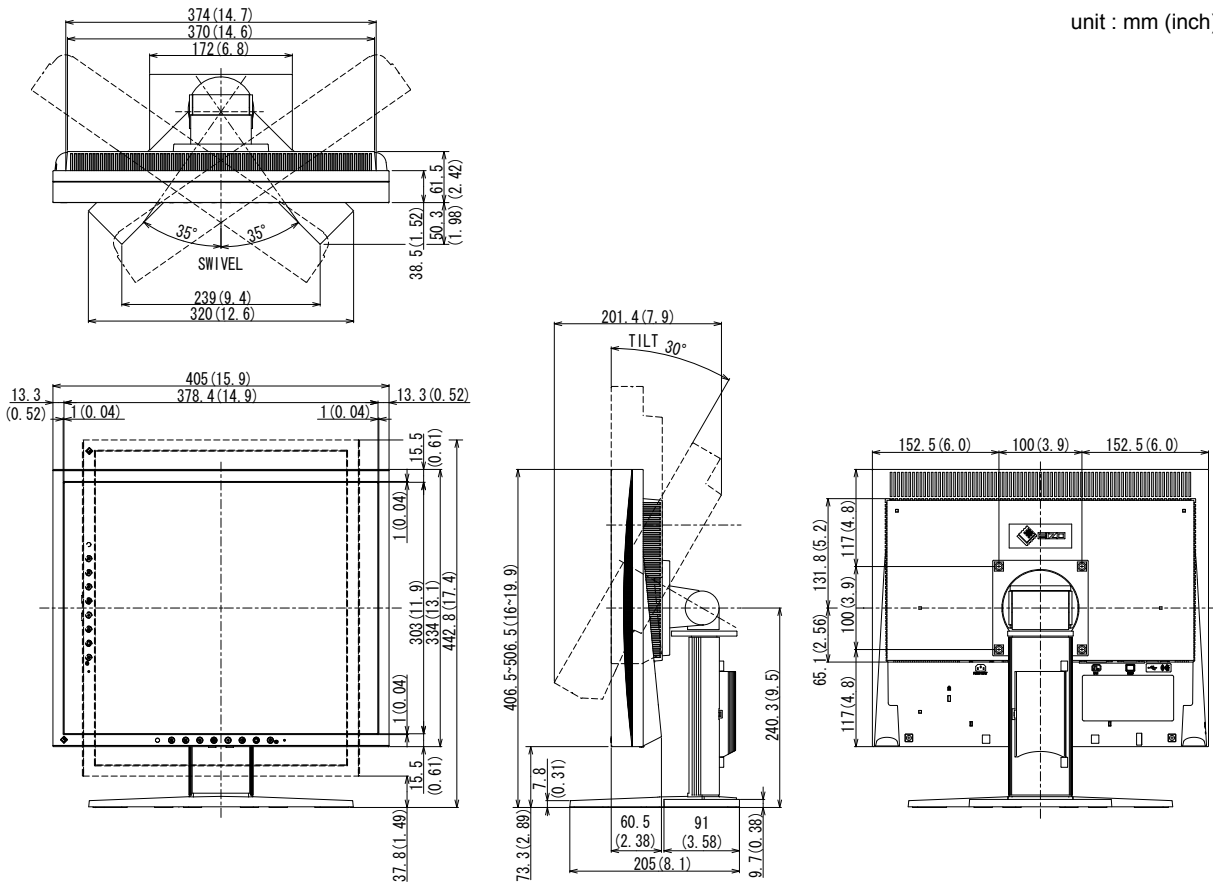

Outside Dimensions (ArcSwing2 stand)

unit : mm (inch)

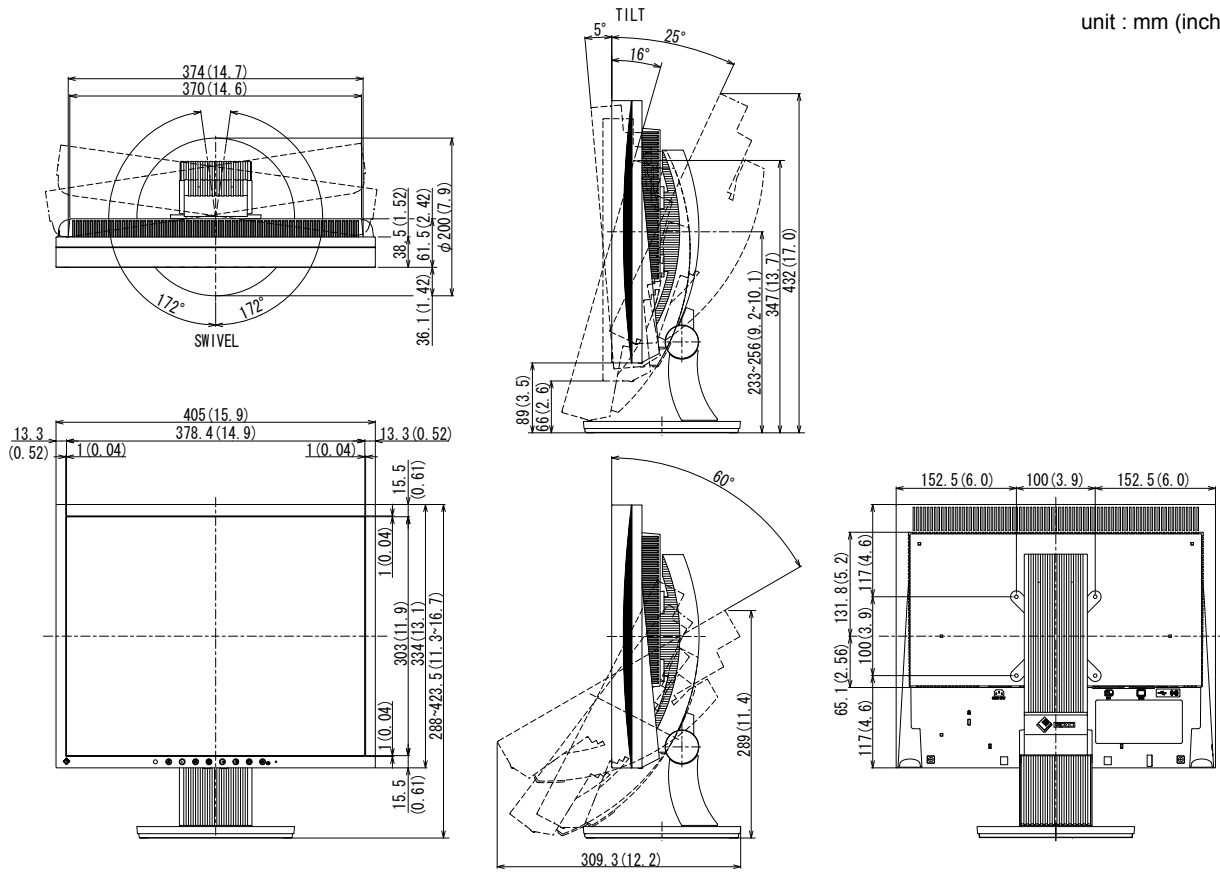

Outside Dimensions (EZ-UP stand)

unit : mm (inch)

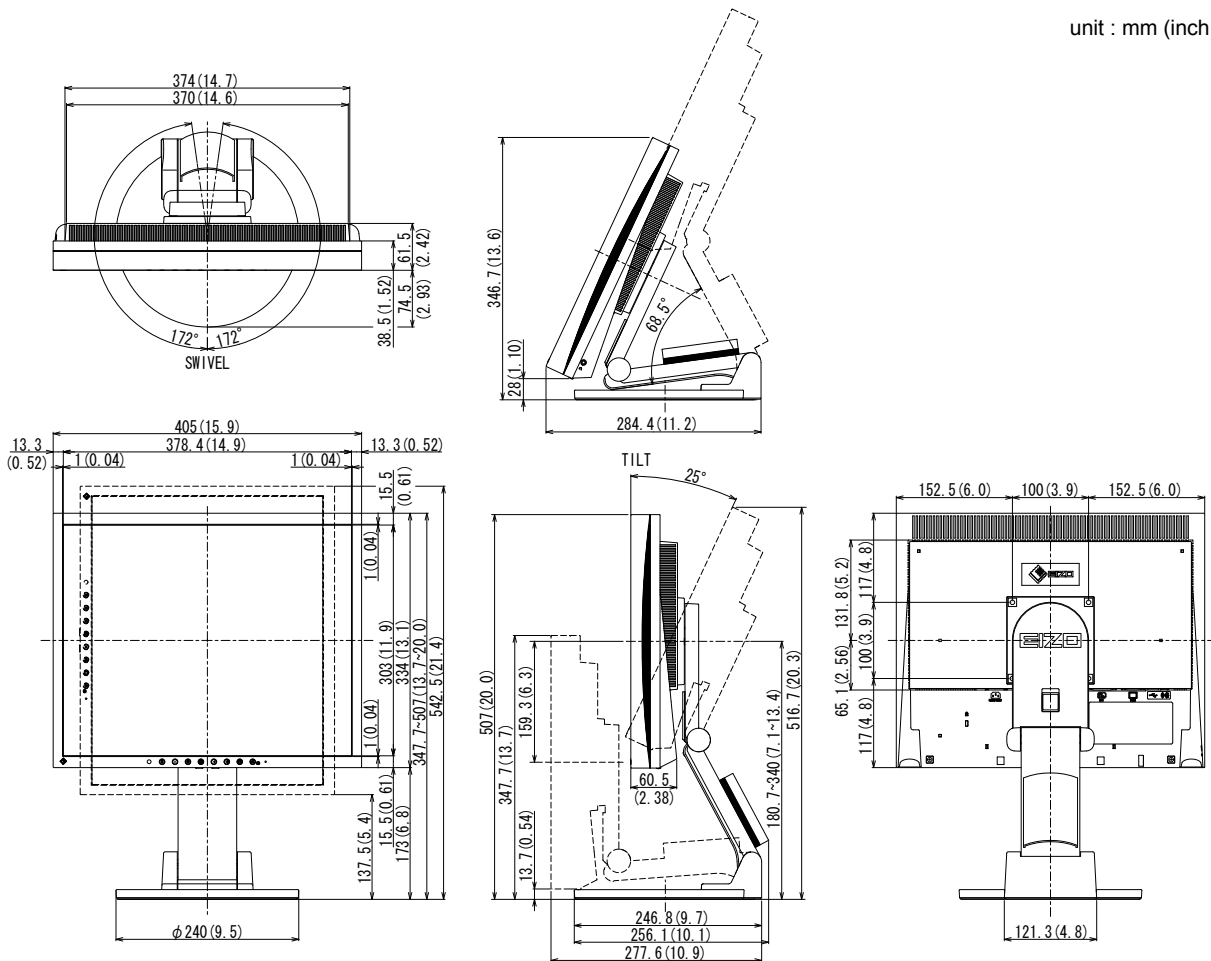

Connector Pin Assignment

- DVI-D connector

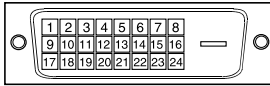

Pin No.	Signal	Pin No.	Signal	Pin No.	Signal
1	T.M.D.S. Data 2-	9	T.M.D.S. Data1-	17	T.M.D.S. Data0-
2	T.M.D.S. Data 2+	10	T.M.D.S. Data1+	18	T.M.D.S. Data0+
3	T.M.D.S. Data2/4 Shield	11	T.M.D.S. Data1/3 Shield	19	T.M.D.S. Data0/5 Shield
4	NC*	12	NC*	20	NC*
5	NC*	13	NC*	21	NC*
6	DDC Clock (SCL)	14	+5V Power	22	T.M.D.S. Clock shield
7	DDC Data (SDA)	15	Ground (return for +5V, Hsync, and Vsync)	23	T.M.D.S. Clock+
8	NC*	16	Hot Plug Detect	24	T.M.D.S. Clock-

(NC*: No Connection)

- D-Sub mini 15-pin connector

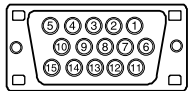

Pin No.	Signal	Pin No.	Signal	Pin No.	Signal
1	Red video	6	Red video ground	11	Ground
2	Green video	7	Green video ground	12	Data (SDA)
3	Blue video	8	Blue video ground	13	H. Sync
4	Ground	9	NC*	14	V. Sync
5	NC*	10	Ground	15	Clock (SCL)

(NC*: No Connection)

- USB port

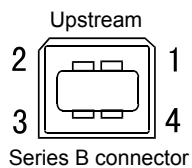

Contact No.	Signal	Remarks
1	VCC	Cable power
2	- Data	Serial data
3	+ Data	Serial data
4	Ground	Cable ground

Option List

Cleaning Kit	EIZO ScreenCleaner
Speaker Unit	i•Sound L3

5-5 Glossary

Clock

The analog input monitor needs to reproduce a clock of the same frequency as the dot clock of the graphics system in use, when the analog input signal is converted to a digital signal for image display.

This is called clock adjustment. If the clock pulse is not set correctly, some vertical bars appear on the screen.

Contrast Enhancer

Contrast Enhancer functions to reproduce images with a taste of contrast by compensating the gamma value as well as controlling the backlight brightness and the gain level according to the image status.

DDC/CI (Display Data Channel/Command Interface)

VESA provides the standardization for the interactive communication of the setting information, etc. between a PC and the monitor.

DVI (Digital Visual Interface)

DVI is a digital interface standard. DVI allows direct transmission of the PC's digital data without loss.

This adopts the TMDS transmission system and DVI connectors. There are two types of DVI connectors. One is a DVI-D connector for digital signal input only. The other is a DVI-I connector for both digital and analog signal inputs.

DVI DMPM (DVI Digital Monitor Power Management)

DVI DMPM is a digital interface power-saving function. The "Monitor ON (operating mode)" and "Active Off (power-saving mode)" are indispensable for DVI DMPM as the monitor's power mode.

Gain

This is used to adjust each color parameter for red, green and blue. An LCD monitor displays the color by the light passing through the panel color filter. Red, green and blue are the three primary colors. All the colors on the screen are displayed by combining these three colors. The color tone can be changed by adjusting the light intensity (volume) passing through each color's filter.

Gamma

Generally, the monitor brightness varies nonlinearly with the input signal level, which is called "Gamma Characteristic". A small gamma value produces a low-contrast image, while a large gamma value produces a high-contrast image.

HDCP (High-bandwidth Digital Contents Protection)

Digital signal coding system developed to copy-protect the digital contents, such as video, music, etc. This helps to transmit the digital contents safely by coding the digital contents sent via DVI terminal on the output side and decoding them on the input side.

Any digital contents cannot be reproduced if both of the equipments on the output and input sides are not applicable to HDCP system.

Phase

Phase means the sampling timing to convert the analog input signal to a digital signal. Phase adjustment is made to adjust the timing. It is recommended that phase adjustment be made after the clock is adjusted correctly.

Range Adjustment

Range adjustment controls the signal output levels to display every color gradation. It is recommended that range adjustment be made before color adjustment.

Resolution

The LCD panel consists of numerous pixels of specified size, which are illuminated to form images. This monitor consists of 1280 horizontal pixels and 1024 vertical pixels. At a resolution of 1280 x 1024, all pixels are illuminated as a full screen (1:1).

sRGB (Standard RGB)

International standard for “color reproduction and color space” among peripheral devices (such as monitors, printers, digital cameras, scanners). sRGB allows Internet users to closely match colors as a simple color matching means for the Internet use.

Temperature

Color temperature is a method to measure the white color tone, generally indicated in degrees Kelvin. The screen becomes reddish at a low temperature, and bluish at a high temperature, like the flame temperature.

5000K: Slightly reddish white

6500K: Warm white like paper white

9300K: Slightly bluish white

TMDs (Transition Minimized Differential Signaling)

A signal transmission system for digital interface.

VESA DPMS (Video Electronics Standards Association - Display Power Management Signaling)

VESA provides the standardization of signals from PC (graphics board) for power saving of PC monitors. DPMS defines the signal status between PC and monitor.

5-6 Preset Timing

The following table shows factory preset video timing (for analog signal only).

Mode	Dot clock		Frequency		Polarity
			Horizontal: kHz	Vertical: Hz	
VGA 640×480@60Hz	25.2 MHz	Horizontal	31.47	Negative	
		Vertical	59.94	Negative	
VGA 720×400@70Hz	28.3 MHz	Horizontal	31.47	Negative	
		Vertical	70.09	Positive	
Macintosh 640×480@67Hz	30.2 MHz	Horizontal	35.00	Negative	
		Vertical	66.67	Negative	
Macintosh 832×624@75Hz	57.3 MHz	Horizontal	49.72	Negative	
		Vertical	74.55	Negative	
Macintosh 1152×870@75Hz	100.0 MHz	Horizontal	68.68	Negative	
		Vertical	75.06	Negative	
Macintosh 1280×960@75Hz	126.2 MHz	Horizontal	74.76	Positive	
		Vertical	74.76	Positive	
VESA 640×480@72Hz	31.5 MHz	Horizontal	37.86	Negative	
		Vertical	72.81	Negative	
VESA 640×480@75Hz	31.5 MHz	Horizontal	37.50	Negative	
		Vertical	75.00	Negative	
VESA 800×600@56Hz	36.0 MHz	Horizontal	35.16	Positive	
		Vertical	56.25	Positive	
VESA 800×600@60Hz	40.0 MHz	Horizontal	37.88	Positive	
		Vertical	60.32	Positive	
VESA 800×600@72Hz	50.0 MHz	Horizontal	48.08	Positive	
		Vertical	72.19	Positive	
VESA 800×600@75Hz	49.5 MHz	Horizontal	46.88	Positive	
		Vertical	75.00	Positive	
VESA 1024×768@60Hz	65.0 MHz	Horizontal	48.36	Negative	
		Vertical	60.00	Negative	
VESA 1024×768@70Hz	75.0 MHz	Horizontal	56.48	Negative	
		Vertical	70.07	Negative	
VESA 1024×768@75Hz	78.8 MHz	Horizontal	60.02	Positive	
		Vertical	75.03	Positive	
VESA 1152×864@75Hz	108.0 MHz	Horizontal	67.50	Positive	
		Vertical	75.00	Positive	
VESA 1280×960@60Hz	108.0 MHz	Horizontal	60.00	Positive	
		Vertical	60.00	Positive	
VESA 1280×1024@60Hz	108.0 MHz	Horizontal	63.98	Positive	
		Vertical	60.02	Positive	
VESA 1280×1024@75Hz	135.0 MHz	Horizontal	79.98	Positive	
		Vertical	75.03	Positive	
PC-9801 640×400@56Hz	21.1 MHz	Horizontal	24.83	Negative	
		Vertical	56.42	Negative	
PC-9821 AP2 640×400@70Hz	25.2 MHz	Horizontal	31.48	Negative	
		Vertical	70.10	Negative	

Attention

- Display position may be deviated depending on the PC connected, which may require screen adjustment using Adjustment menu.
- If a signal other than those listed in the table is input, adjust the screen using the Adjustment menu. However, screen display may still be incorrect even after the adjustment.
- When interlace signals are used, the screen cannot be displayed correctly even after screen adjustment using the Adjustment menu.



Congratulations!

The display you have just purchased carries the TCO'03 Displays label. This means that your display is designed, manufactured and tested according to some of the strictest quality and environmental requirements in the world. This makes for a high performance product, designed with the user in focus that also minimizes the Impact on our natural environment.

Some of the features of the TCO'03 Display requirements:

Ergonomics

- Good visual ergonomics and image quality in order to improve the working environment for the user and to reduce sight and strain problems. Important parameters are luminance, contrast, resolution, reflectance, colour rendition and image stability.

Energy

- Energy-saving mode after a certain time - beneficial both for the user and environment
- Electrical safety

Emissions

- Electromagnetic fields
- Noise emissions

Ecology

- The products must be prepared for recycling and the manufacturer must have a certified environmental management system such as EMAS or ISO 14000
- Restrictions on
 - chlorinated and brominated flame retardants and polymers
 - heavy metals such as cadmium, mercury and lead.

The requirements included in this label have been developed by TCO Development in co-operation with scientists, experts, users as well as manufacturers all over the world. Since the end of the 1980s TCO has been involved in influencing the development of IT equipment in a more user-friendly direction. Our labeling system with displays in 1992 and is now requested by users and IT-manufacturers all over the world.

**For more information, please visit
www.tcodevelopment.com**

For U.S.A. , Canada, etc. (rated 100-120 Vac) Only

FCC Declaration of Conformity

We, the Responsible Party

EIZO NANAOTECHNOLOGIES INC.

5710 Warland Drive, Cypress, CA 90630

Phone: (562) 431-5011

declare that the product

Trade name: EIZO

Model: FlexScan S1932

is in conformity with Part 15 of the FCC Rules. Operation of this product is subject to the following two conditions: (1) this device may not cause harmful interference, and (2) this device must accept any interference received, including interference that may cause undesired operation.

This equipment has been tested and found to comply with the limits for a Class B digital device, pursuant to Part 15 of the FCC Rules. These limits are designed to provide reasonable protection against harmful interference in a residential installation. This equipment generates, uses, and can radiate radio frequency energy and, if not installed and used in accordance with the instructions, may cause harmful interference to radio communications. However, there is no guarantee that interference will not occur in a particular installation. If this equipment does cause harmful interference to radio or television reception, which can be determined by turning the equipment off and on, the user is encouraged to try to correct the interference by one or more of the following measures.

- * Reorient or relocate the receiving antenna.
- * Increase the separation between the equipment and receiver.
- * Connect the equipment into an outlet on a circuit different from that to which the receiver is connected.
- * Consult the dealer or an experienced radio/TV technician for help.

Changes or modifications not expressly approved by the party responsible for compliance could void the user's authority to operate the equipment.

Note

Use the attached specified cable below or EIZO signal cable with this monitor so as to keep interference within the limits of a Class B digital device.

- AC Cord
- Shielded Signal Cable (enclosed)

Canadian Notice

This Class B digital apparatus complies with Canadian ICES-003.

Cet appareil numérique de la classe B est conforme à la norme NMB-003 du Canada.

Hinweise zur Auswahl des richtigen Schwenkarms für Ihren Monitor

Dieser Monitor ist für Bildschirmarbeitsplätze vorgesehen. Wenn nicht der zum Standardzubehör gehörige Schwenkarm verwendet wird, muss statt dessen ein geeigneter anderer Schwenkarm installiert werden. Bei der Auswahl des Schwenkarms sind die nachstehenden Hinweise zu berücksichtigen:

Der Standfuß muß den nachfolgenden Anforderungen entsprechen:

- a) Der Standfuß muß eine ausreichende mechanische Stabilität zur Aufnahme des Gewichtes vom Bildschirmgerät und des spezifizierten Zubehörs besitzen. Das Gewicht des Bildschirmgerätes und des Zubehörs sind in der zugehörigen Bedienungsanleitung angegeben.
- b) Die Befestigung des Standfusses muß derart erfolgen, daß die oberste Zeile der Bildschirmanzeige nicht höher als die Augenhöhe eines Benutzers in sitzender Position ist.
- c) Im Fall eines stehenden Benutzers muß die Befestigung des Bildschirmgerätes derart erfolgen, daß die Höhe der Bildschirmmitte über dem Boden zwischen 135 – 150 cm beträgt.
- d) Der Standfuß muß die Möglichkeit zur Neigung des Bildschirmgerätes besitzen (max. vorwärts: 5°, min. nach hinten $\geq 5^\circ$).
- e) Der Standfuß muß die Möglichkeit zur Drehung des Bildschirmgerätes besitzen (max. $\pm 180^\circ$). Der maximale Kraftaufwand dafür muß weniger als 100 N betragen.
- f) Der Standfuß muß in der Stellung verharren, in die er manuell bewegt wurde.
- g) Der Glanzgrad des Standfusses muß weniger als 20 Glanzeinheiten betragen (seidenmatt).
- h) Der Standfuß mit Bildschirmgerät muß bei einer Neigung von bis zu 10° aus der normalen aufrechten Position kippstabil sein.

Hinweis zur Ergonomie :

Dieser Monitor erfüllt die Anforderungen an die Ergonomie nach EK1-ITB2000 mit dem Videosignal, 1280 × 1024, Digital Eingang und mindestens 60,0 Hz Bildwiederholfrequenz, non interlaced. Weiterhin wird aus ergonomischen Gründen empfohlen, die Grundfarbe Blau nicht auf dunklem Untergrund zu verwenden (schlechte Erkennbarkeit, Augenbelastung bei zu geringem Zeichenkontrast.)

Übermäßiger Schalldruck von Ohrhörern bzw. Kopfhörern kann einen Hörverlust bewirken.

Eine Einstellung des Equalizers auf Maximalwerte erhöht die Ausgangsspannung am Ohrhörer- bzw. Kopfhörerausgang und damit auch den Schalldruckpegel.

„Maschinenlärminformations-Verordnung 3. GPSGV:

Der höchste Schalldruckpegel beträgt 70 dB(A) oder weniger gemäss EN ISO 7779“

[Begrenzung des maximalen Schalldruckpegels am Ohr]
Bildschirmgeräten: Größte Ausgangsspannung 150 mV

