

# User's Manual

# FlexScan<sup>®</sup> T566

Color Display Monitor

## **Important**

Please read this User's Manual carefully to familiarize yourself with safe and effective usage procedures. Please retain this manual for future reference.



## SAFETY SYMBOLS

This manual uses the safety symbols below. They denote critical information. Please read them carefully.



### WARNING

Failure to abide by the information in a WARNING may result in serious injury and can be life threatening.



### CAUTION

Failure to abide by the information in a CAUTION may result in moderate injury and/or property or product damage.



Indicates a prohibited action.



Indicates to ground for safety.

---

Copyright© 2002 by EIZO NANA0 CORPORATION. All rights reserved. No part of this manual may be reproduced, stored in a retrieval system, or transmitted, in any form or by any means, electronic, mechanical, or otherwise, without the prior written permission of Eizo Nanao Corporation.

Eizo Nanao Corporation is under no obligation to hold any submitted material or information confidential unless prior arrangements are made pursuant to Eizo Nanao Corporation's receipt of said information. Although every effort has been made to ensure that this manual provides up-to-date information, please note that EIZO monitor specifications are subject to change without notice.

---

ENERGY STAR is a U.S. registered mark.

Apple and Macintosh are registered trademarks of Apple Computer, Inc.

VGA is a registered trademark of International Business Machines Corporation.

DPMS is a trademark and VESA is a registered trademark of Video Electronics Standards Association.

Windows is a registered trademark of Microsoft Corporation.

ScreenManager and PowerManager, QuickSet and i-Sound are trademarks of Eizo Nanao Corporation.

FlexScan, SuperErgoCoat and EIZO are registered trademarks of Eizo Nanao Corporation.

---



As an ENERGY STAR® Partner, Eizo Nanao Corporation has determined that this product meets the ENERGY STAR guidelines for energy efficiency.

---

# TABLE OF CONTENTS

 <b>PRECAUTIONS</b> .....	<b>4</b>
<b>1. INTRODUCTION</b> .....	<b>8</b>
1-1. Features .....	8
1-2. Package Contents.....	8
1-3. Controls & Connectors .....	9
<b>2. INSTALLATION</b> .....	<b>10</b>
2-1. Connecting the monitor to the PC .....	10
2-2. Getting Ready for Operation .....	12
<b>3. SCREEN ADJUSTMENT</b> .....	<b>13</b>
3-1. How to use the ScreenManager .....	13
3-2. Fine Contrast .....	15
3-3. Color .....	16
3-4. Power Save .....	18
3-5. Adjustment Lock .....	19
3-6. Connecting two PCs to the Monitor .....	20
<b>4. TROUBLESHOOTING</b> .....	<b>21</b>
<b>5. CLEANING</b> .....	<b>26</b>
<b>6. SPECIFICATIONS</b> .....	<b>27</b>
<b>7. GLOSSARY</b> .....	<b>30</b>

# PRECAUTIONS

## IMPORTANT!

- This product has been adjusted specifically for use in the region to which it was originally shipped. If operated outside the region to which it was originally shipped, the product may not perform as stated in the specifications.
- To ensure personal safety and proper maintenance, please read this section and the caution statements on the unit (refer to the figure below).

### [Location of the Caution Statements]



The equipment must be connected to a grounded main outlet.  
 Jordat sikkontakt skal benyttes når apparatet tikobles datanett.  
 Apparaten skall anslutas till jordat näuttag.  
 電源コードのアースは必ず接地してください。

	<b>警告</b> <b>高圧注意</b> サービスマン以外の方は裏ふたを あけないでください。 内部には高電圧部分が数多くあり、 万一さわると危険です。	<b>CAUTION</b> RISK OF ELECTRIC SHOCK. DO NOT OPEN.	<b>ATTENTION</b> RISQUE DE CHOC ELECTRIQUE. NE PAS OUVRIIR.	<b>ACHTUNG</b> GEFAHR DES ELEKTRISCHEN SCHLAGES. RÜCKWAND NICHT ENTFERNEN.	
---	--	--	--	---	---

## WARNING

**If the unit begins to emit smoke, smells like something is burning, or makes strange noises, disconnect all power connections immediately and contact your dealer for advice.**

Attempting to use a malfunctioning unit can be dangerous.

**Do not dismantle the cabinet or modify the unit.**

Dismantling the cabinet or modifying the unit may result in electric shock or burn.



**Refer all servicing to qualified service personnel.**

Do not attempt to service this product yourself as opening or removing covers may expose you to dangerous voltage or other hazards.

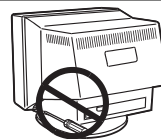

## WARNING

### Keep small objects or liquids away from the unit.

Small objects accidentally falling through the ventilation slots into the cabinet or spillage into the cabinet may result in fire, electric shock, or equipment damage.

If an object or liquid falls/spills into the cabinet, unplug the unit immediately. Have the unit checked by a qualified service engineer before using it again.

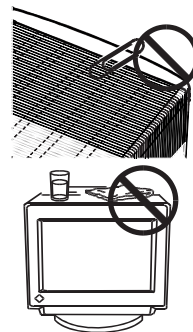

### Place the unit on a strong, stable surface.

A unit placed on an inadequate surface may fall, resulting in injury or equipment damage.

When the unit is dropped, please ask your dealer for advice. Do not continue using a damaged unit. Using a damaged unit may result in fire or electric shock.

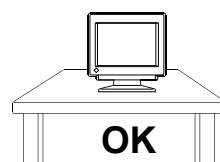

### Set the unit in an appropriate location.

Not doing so may cause damage and could result in fire or electric shock.

- \* Do not place in outdoors.
- \* Do not place in the transportation system (ship, aircraft, trains, automobiles, etc.)
- \* Do not install in a dusty or humid environment.
- \* Do not place in a location where the steam comes directly on the screen.
- \* Do not place near heat generating devices or a humidifier.

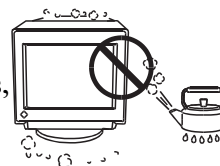

### To avoid danger of suffocation, keep the plastic packing bags away from babies and children.



### Use the enclosed power cord and connect to the standard power outlet of your country. Be sure to remain within the rated voltage of the power cord.

Not doing so may cause in fire or electric shock.

### To disconnect the power cord, grasp the plug firmly and pull.

Never tug on the cord, doing so may cause damage and could result in fire or electric shock.



## **WARNING**

---

### **The equipment must be connected to a grounded main outlet.**

Not doing so may cause in fire or electric shock.



### **Use the correct voltage.**

- \* Do not overload your power circuit, as this may result in fire or electric shock.
  - \* The unit is designed for use with a specific voltage only. Connection to another voltage than specified in this User's Manual may cause fire, electric shock, or other damage.
  - \* Do not overload your power circuit, as this may result in fire or electric shock.
- 

### **Handle the power cord with care.**

- \* Do not place the cord underneath the unit or other heavy objects.
- \* Do not pull on or tie the cord.

If the power cord becomes damaged, stop using it. Use of a damaged cord may result in fire or electric shock.

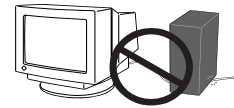

### **Never touch the plug and power cord if it begins to thunder.**

Touching them may result in electric shock.

---

---

## CAUTION

---

### **Handle with care when carrying the unit.**

Disconnect the power cord and cables and remove the optional unit. Moving the unit with the cord or the option attached is dangerous. It may result in injury or equipment damage.

### **Do not move it alone. Always work with another person.**

Moving it alone may cause lower back pain. Also note that the unit is heavier at the front than at the rear.



### **Do not block the ventilation slots on the cabinet.**

- \* Do not place books or any other papers on the ventilation slots.
- \* Do not install the unit in a closed space.
- \* Do not use the unit lying down or upside down.
- \* Do not remove the tilt-swivel stand.

Using the unit in these ways blocks the ventilation slots and prevents proper airflow, leading to fire or other damage.

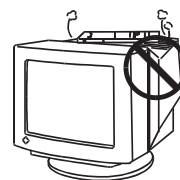

### **Do not sit on the cabinet or place any heavy objects on the cabinet.**

A unit with heavy objects on it may fall or be damaged and result in injury.

### **Do not touch the plug with wet hands.**

Touching them may result in electric shock.



### **Use an easily accessible power outlet.**

This will ensure that you can disconnect the power quickly in case of a problem.

### **Periodically clean the area around the plug.**

Buildup of dust, water, or oil on the plug may result in fire.

### **Unplug the unit before cleaning it.**

Cleaning the unit while it is plugged into a power outlet may result in electric shock.

**If you plan to leave the unit unused for an extended period, disconnect the power cord from the wall socket after turning off the power switch for the safety and the power conservation.**

---

# 1. INTRODUCTION

Thank you very much for choosing an EIZO Color Display Monitor.

## 1-1. Features

- Horizontal scanning frequency of 30-96kHz  
Vertical scanning frequency of 50-160 Hz
- Support to sRGB standard (See page 31.)
- Max Brightness 400 cd/m<sup>2</sup> bright screen (when the movie mode is selected.)
- The color restoration circuit that can keep stable brightness and color-tone for a long period supported (See page 16.)
- Fine contrast modes, to adjust the most suitable brightness and contrast of the screen (See page 15.)
- The EIZO CRT Utility Disk enclosed (See readme.txt in the CD-ROM for details.)
  - The utility software “ScreenManager Pro for USB” (for Windows) to control a monitor from a PC with a mouse and a keyboard
  - The software “ActiveGamma” (for Windows/Macintosh) to assign fine contrast modes to applications
  - The software “DesktopViewer” (for Windows) to display bright and clear still images

## 1-2. Package Contents

Please contact your local dealer for assistance if any of the listed items are missing or damaged.

- Monitor
- Power Cord
- Signal Cable (MD-C87 or MD-C100)
- Setup Guide
- EIZO CRT Utility Disk (for Windows/Macintosh)
- EIZO USB Cable (MD-C93)
- LIMITED WARRANTY

### **NOTE**

- Please retain the packing materials for future transference.
- The EIZO USB cable is used when using the software in the EIZO CRT Utility Disk. For information on the software, refer to the readme.txt in the EIZO CRT Utility Disk.



## 1-3. Controls & Connectors

Front

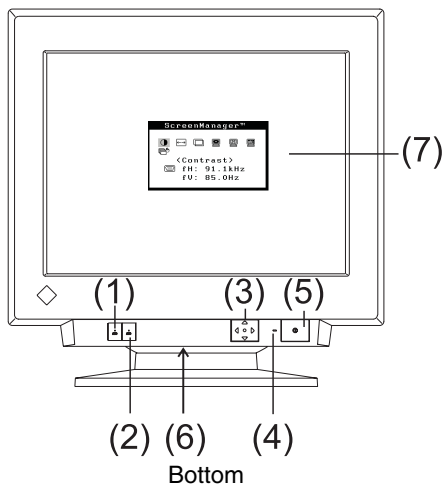

Rear

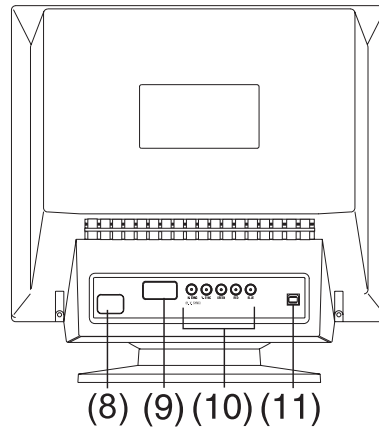

- (1) BNC/D-SUB Selection Button
- (2) AUTO/FINE MODE button  
Push the button lightly: Fine Contrast Mode Selection button  
Press and hold the button more than 2 seconds: AUTO-SIZING button
- (3) QuickSet™ Control Pad  
(Hereinafter "Control Pad")
- (4) Power Indicator

Green	Power is on (Normal mode)
Flashing Green	Power save (Mode 1) Advance notice of monitor's Off Timer <sup>1</sup>
Yellow	Power save (Mode 2)
Flashing Yellow	Power save mode with monitor's Off Timer <sup>1</sup>
Off	Power is off

- (5) Power Switch
- (6) Power Terminal<sup>2</sup> (with a cover)
- (7) ScreenManager™
- (8) Power Connector
- (9) D-Sub mini 15 pin connector
- (10) BNC Input Connector
- (11) USB Port<sup>3</sup>  
Upstream port x 1

<sup>1</sup> Regarding the "Off Timer", see page 19.

<sup>2</sup> Power Terminal can be used with an optional *i:Sound* Sound Unit.

<sup>3</sup> USB Port is used when using the software EIZO CRT Utility Disk. (See page 11.)

# 2. INSTALLATION

## 2-1. Connecting the monitor to the PC

### NOTE

- Be sure that the power switches of both of the PC and the monitor are OFF.

1. Plug the signal cable into the connector at the rear of the monitor and the other end of the cable into the video connector on the PC.

After connecting, secure the connection with the screw-in fasteners.

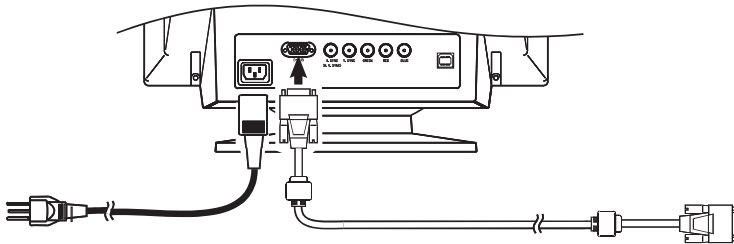

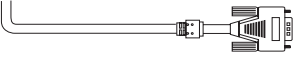
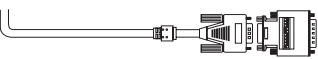
Signal Cable	Connector	PC
Signal Cable (enclosed) 	D-Sub mini 15 pin connector	<ul style="list-style-type: none"> <li>● Standard Graphics Board</li> <li>● Macintosh G3 (Blue &amp; White) / G4</li> </ul>
Signal Cable (enclosed) + Adapter* (optional) 	D-Sub 15 pin connector	<ul style="list-style-type: none"> <li>● Macintosh</li> <li>* Macintosh Adapter (optional)</li> </ul>

2. Plug the power cord into the power connector at the rear of the monitor. Then, plug the other end of the cord into a power outlet.

## WARNING

**Use the enclosed power cord and connect to the standard power outlet of your country.**

Be sure to remain within the rated voltage of the power cord.

Not doing so may cause in fire or electric shock.

**The equipment must be connected to a grounded main outlet.**

Not doing so may cause in fire or electric shock.



### 3. Turn on the monitor first, then the PC.

Turn on the monitor first, then the PC. The monitor's power indicator will light up (green).

The monitor will warm up briefly, then display an image.

Whenever finishing your operation, turn off the PC and the monitor. (If an image does not appear, make sure that all connections have been made properly. Refer to the "4. TROUBLESHOOTING" (See page 21) for additional advice).

### 4. When using the software in the EIZO CRT Utility Disk: Connect the upstream port of the monitor to the downstream port of the USB compliant PC or another hub with the USB cable.

After connecting the USB cable, the USB function can be set up automatically. For further details about the "ScreenManager Pro for USB", refer to the readme.txt in the CD-ROM.

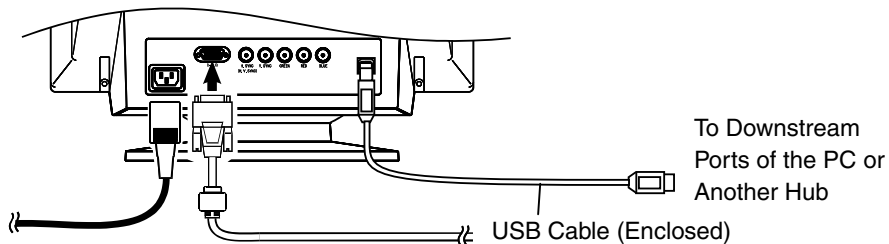

#### NOTE

- Generally, for maximum viewing comfort, position the monitor slightly below eye level. Staring at the monitor for prolonged periods can cause eyestrain. Be sure to take adequate rests. (A 10-minute rest period each hour is suggested).



## 2-2. Getting Ready for Operation

Try each setting procedure if necessary in the following cases.

### The display image size and/or position is not appropriate.

→ Press the AUTO/FINE MODE button on the front panel for more than 2 seconds.

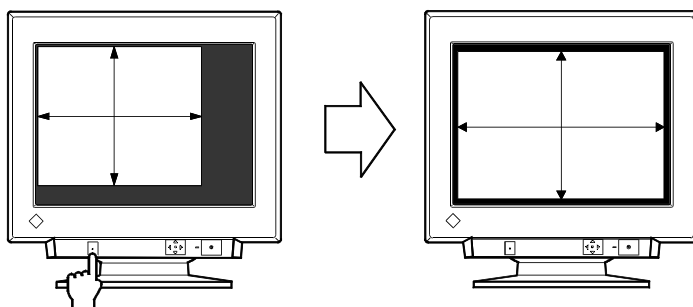

The AUTO-SIZING function centers the displayed image, aligning the image's borders with respect to the monitor frame. In general, press the AUTO/FINE MODE button whenever changing the graphics card or the resolution (p. 31), or when image size and/or position is incorrect.

#### NOTE

- Pushing the AUTO/FINE MODE button lightly allows changing of the Fine Contrast mode.

### The display area is too large or too small.

→ Readjust the refresh rates.

Readjust the preferred refresh rates in accordance with the following look-up-table. Refer to the PC or graphics card manuals on how to change the refresh rates.

#### [The maximum (non-interlaced) vertical refresh rates for the model]

Horizontal frequency (kHz)	Maximum Vertical Refresh rate (Hz)				
	640×480	800×600	1024×768	1280×1024	1600×1200
30-96	160	144	118	89	76

#### NOTE

- About Plug & Play of the monitor  
When your computer and monitor support VESA DDC, the suitable resolution and the refresh rate are set by just plugging your monitor into the computer without any manual settings. When your computer system supports Plug & Play, the Display Information File is not required except for installing the Color Profile.

### Further adjustment is required

→ Adjust the screen using the ScreenManager. (See page 13.)

# 3. SCREEN ADJUSTMENT

## NOTE

- Allow the monitor to stabilize for at least 30 minutes before making image adjustments.

## 3-1. How to use the ScreenManager

Use the control pad on the front panel. The control pad can be pressed in 5 directions, Enter, Up, Down, Left and Right.

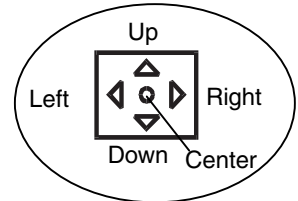

### 1. Entering the ScreenManager

Display the ScreenManager Main menu by pressing the Enter of the control pad. Main menu displays the current connector type and frequency of the input signal.

[Main Menu]



### 2. Making Adjustments and Settings

- (1) Select the desired icon by using Up, Down, Left and Right keys.
- (2) Press the Enter key to display each adjustment/setting menu or Sub menu.
- (3) Make the required adjustments/settings by using the control pad.
- (4) To save the adjustments/settings and return to the Main menu, press the Enter key.

### 3. Exiting the ScreenManager

To exit the ScreenManager, select the <Exit> from the Main menu and press the Enter key.

Pushing the down arrow key twice goes to the <Exit> position instantly.

**NOTE**

- Leaving the ScreenManager idle for 45 seconds or more will turn the adjustment off automatically without saving.
- The brightness and contrast can be adjusted by pressing the Up, Down, Left and Right keys of the control pad directly. Press the center of the control pad to save and exit the settings after the adjustment.

**Adjustments and Settings**

Main Menu	Sub menu	Adjustments and Settings	See page
Contrast	-	Screen contrast and brightness	-
Size	-	Screen Size	-
Position	-	Screen position	-
Screen	Side Pin.	Side pin balance	-
	Trapezoidal	Distortion	-
	Tilt	Inclination	-
	Convergence	Convergence (p. 30)	p. 23
	Moiré Reduction	Moiré (p. 30)	p. 22
	Fine Contrast	To Select Movie Settings (1 to 4)	p. 15
	Video Level	To set the video level	p. 23
Color	Color Mode	To select the adjustment mode from standard custom or sRGB	p. 16
	•Standard		p. 16
	Temperature	To set the color temperature. (p. 30)	p. 16
	Color Restoration	To restore the changed brightness and the color caused by long use to close to those original ones.	p. 16
	•Custom	To adjust each color, (Red, Green and Blue)	p. 17
	•sRGB	To select sRGB (p. 31)	p. 17
Others	Power Manager	To set the power save (with PC's power saving system)	p. 18
	Off Timer	To set the power save (with Monitor's off timer)	p. 19
	Degauss	To degauss (p. 30)	p. 23
	Menu Position	To adjust the menu position of the ScreenManager	-
	Input Priority	To select the priority input signal	p. 20
	Reset	To return to the factory default setting	p. 23
	Information	To know the total usage time	p. 16

## 3-2. Fine Contrast

The fine contrast modes differ in brightness and contrast settings. Select the mode that is the best suited to the application in use. The mode can be changed with the AUTO/FINE MODE button that is on the front of the monitor.

### To select the most suitable brightness mode

→ Push AUTO/FINE MODE button lightly.

Select from the following modes to adjust the most suitable brightness of the screen. Pushing this button displays the fine contrast modes in the following order.

(Text→ Browser→ Picture→ Graphic→ Movie→ Text...)

Text	Text on word processor or spreadsheet software
Browser	Text and picture image (ex. home page)
Picture	The photo or picture image
Graphic	Animation or illustration (Contrast is not enhanced.)
Movie* <sup>1</sup>	The animated image (games or DVDs) dark still images

#### NOTE

- When changing the mode or adjusting the contrast, the brightness of the screen might change for a split second.
- The color temperature and the brightness can be set in the each mode.
- \*<sup>1</sup>There are 4 kinds of movie mode settings. Set the mode by using the <Fine Contrast> in the <Screen> menu (Refer to the following section for details).

### To select proper Movie Mode

→  Select a proper Movie Mode in <Fine Contrast>.

Select a mode from the following 4 options when adjusting the contrast or the sharpness settings.

Set the mode by using the <Fine Contrast> in the <Screen> menu.

Mode	Enhanced contrast <sup>2</sup>	Enhanced sharpness	Suitable for;
Movie 1	ON	ON	DVDs and TV with full-screen
Movie 2	ON	OFF	DVDs and TV with default screen
Movie 3	OFF	ON	When the brightness or sharpness of the input images has been already compensated
Movie 4	OFF	OFF	

<sup>2</sup> To display clear images, the monitor checks the input signal then corrects the mid-range color tone and further adjusts contrast.

## 3-3. Color

By using the <Color Mode> in the <Color> menu, the adjustment mode can be selected from standard mode (to set the color temperature and the color restoration), custom mode (to adjust each color tone, (Red, Green and Blue) and sRGB mode. These modes allow you to adjust the color settings according to your preference.

### <Standard> mode to set the color temperature and the color restoration

#### To set the color temperature

→  K Set the <Temperature>.

Temperature can be set from 4,000 K to 10,000 K, in 500 K increments.  
(Including the 9,300 K default setting.)

#### To restore the changed brightness and the color caused by long use to close to those original ones.

→  Execute the <Color Restoration>.

The changed brightness and the color caused by long use can be corrected and restored to close to those factory default settings.

#### [Adjustment Procedure]



- (1) Execute the <Color Restoration>. (The operation takes about one minute.)
- (2) When color restoration is completed, the original ScreenManager menu is displayed.

#### **NOTE**

- Allow the monitor to stabilize for at least 60 minutes before executing this function. Otherwise, the warning message "Still Warming Up! xx min. remain" will appear on the screen.
- Execute this function in every fixed time (ex. 2000 hours usage), so that you can keep stable brightness and color-tone for a long period.
- The total usage time (in hour) can be checked as the <Information> in the <Others> menu.



## **<Custom> mode: to adjust each color, (Red, Green and Blue)**

→ Adjust the **<  Gain (p. 30)>**, **<  Cutoff (p. 30)>**

Change the <Color Mode> to <Custom>. The values shown in percentages (%) for both the Cutoff and Gain are available only as a reference tool.

### **[Adjustment Procedure]**

- (1) First, set the monitor to maximum contrast and brightness.
- (2) <Temperature> Set the color temperature that is close to the desired color.
- (3) Adjust each color to become a uniform black level by using the <Cutoff> function.
- (4) Adjust each color to the desired white level by using the <Gain> function.
- (5) Select <Save> and then press the Enter key. (The adjustment data will be lost, if the monitor is turned off without saving changes).

## **<sRGB> mode: To select sRGB**

→ Select the **<  sRGB >** in **< Color Mode>**.

During selecting the <sRGB>, color, brightness and contrast cannot be adjusted. Likewise, Fine Contrast Mode can not be changed by the AUTO/FINE MODE button.

## 3-4. Power Save

There are two power save settings. Choose the setting which matches your environment.

Set the power saving by using <Others> menu.

### **NOTE**

- Do your part to conserve energy, turn off the monitor when you are finished using it. Complete energy use can only be accomplished by disconnecting the monitor's power supply cord from the plug receptacle.

### **To use the PC's power saving system (VESA DPMS (p. 31))**

→ Select "ON" in the <PowerManager> menu.

[Procedure]

- (1) Set the PC's power saving settings.
- (2) Select "ON" in the <PowerManager> menu.

[Power saving system]

PC Signal	Screen	Power Indicator
On	Operation	Green
STAND-BY	Blank screen	Green
SUSPEND	Power save (Mode 1)	Flashing Green
Off	Power save (Mode 2)	Yellow

[To return to a normal screen]

Operate the mouse or keyboard.

## To use the Monitor's off timer system

→ Select "Enable" in the <Off Timer> menu.

Without the PC's power saving system, the off timer allows the monitor to enter a power save mode after a predetermined amount of time has lapsed.

### [Procedure]

Select "Enable" and press the left/right keys on the control pad to set the "On period". (1 to 23 hours)

### [To return to a normal screen]

Press any direction of the control pad or to turn the power off then on again to return to a normal screen.

### [Power saving system]

Timer	Screen	Power Indicator
On period (1-23H)	Operation	Green
Last 15 min. in "On period"	Advance notice <sup>*1</sup>	Flashing Green
"On period" expired	Power save mode	Flashing Yellow

<sup>\*1</sup> To delay entering the power save mode, press any direction of the control pad during the advance notice mode. The monitor will continue to operate for an additional 90 minutes.

## 3-5. Adjustment Lock

Use the "Adjustment Lock" function to prevent any accidental changes.

Locked function	<ul style="list-style-type: none"> <li>• Adjust the screen using the ScreenManager.</li> <li>• AUTO/FINE MODE button.</li> </ul>
Unlocked function	<ul style="list-style-type: none"> <li>• Adjustment of contrast and brightness by the shortcut keys.</li> <li>• BNC/D-Sub Selection button</li> </ul>

### [To lock]

Press on the AUTO/FINE MODE button while switching on the monitor's power.

### [To unlock]

Switch off the monitor's power, then hold down the AUTO/FINE MODE button once again and turn the power back on.

## 3-6. Connecting two PCs to the Monitor

Two PCs can be connected to the monitor through the BNC/D-Sub input connections on the rear of the monitor.

(Example)

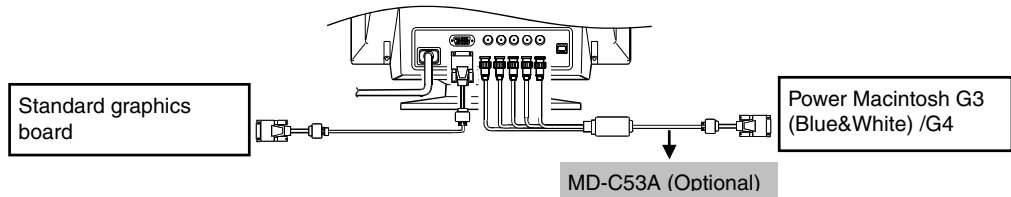

### Selecting the Active input

Every time the BNC/D-Sub selection button is pressed, the input changes in order.

[Automatically selecting the priority input signal for screen]

The monitor will automatically detect the input signal of either the BNC or D-Sub connection for display. In the following cases, the signal given preference will be displayed automatically.

- When the monitor is turned on.
- Once a priority is selected in the <Input Priority> function, whenever a change of signal is detected at the selected input, the monitor will switch the input to that signal.

[How to give priority to the input]

- (1) Select <Input Priority> in the <Others> menu.
- (2) Select <Auto> and set BNC or D-Sub input.

### Saving the adjustment data

The adjustment data can be saved for both signals. However, the following adjustment and setting data can be saved for each input signal (BNC/D-Sub).

<Contrast>, <Fine Contrast>, <Temperature>, <Custom> and <sRGB>

# 4. TROUBLESHOOTING

If a problem persists even after applying the suggested remedies, contact an EIZO dealer.

\*The bracket < > indicates the function of ScreenManager

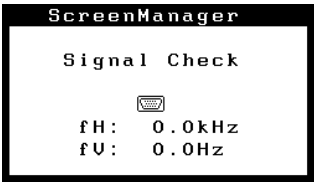
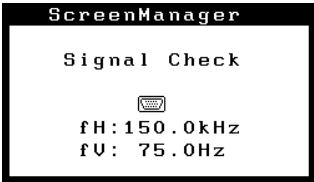
Problems	Points to check with possible solutions
<p><b>1. No picture</b></p> <ul style="list-style-type: none"> <li>Indicator status: Off</li> </ul>	<ul style="list-style-type: none"> <li><input type="checkbox"/> Check that the power cord is correctly connected.</li> <li><input type="checkbox"/> If the problem persists, turn off the monitor power for a few minutes, then turn it back on and try again.</li> </ul>
<ul style="list-style-type: none"> <li>Indicator status: Green</li> <li>Indicator status: Flashing Green</li> <li>Indicator status: Flashing Yellow</li> </ul>	<ul style="list-style-type: none"> <li><input type="checkbox"/> Check the Contrast and Brightness.</li> <li><input type="checkbox"/> Try pressing a key on the keyboard, or clicking the mouse. (p. 18)</li> <li><input type="checkbox"/> Try pressing the AUTO/FINE MODE button or control pad or turn the monitor off and then on. (p. 19)</li> </ul>
<p><b>2. Following messages appear. (Error messages shown below will remain on the screen for 30 seconds.)</b></p> <ul style="list-style-type: none"> <li>"No signal detected" error message appears.</li> </ul> 	<ul style="list-style-type: none"> <li><input type="checkbox"/> These messages appear when the signal is not input correctly, even if the monitor functions properly.</li> <li><input type="checkbox"/> When the image is displayed correctly after a short time, it is not a monitor's problem. (Some PCs do not output the signal soon after powering on).</li> <li><input type="checkbox"/> Check that the PC is turned ON.</li> <li><input type="checkbox"/> Check that the signal cable is properly connected to the PC or graphics board.</li> <li><input type="checkbox"/> Switch the signal input by pressing the BNC/D-Sub selection button on the front control panel.</li> </ul>
<ul style="list-style-type: none"> <li>"Out of range" error message appears. Whenever an error signal message appears, the signal frequency will be displayed in red. (Example)</li> </ul> 	<ul style="list-style-type: none"> <li><input type="checkbox"/> Use the graphics board's utility software to change the frequency setting. (Refer to the manual of the graphics board).</li> </ul>

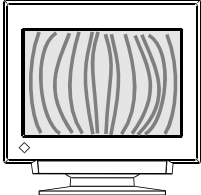
Problems	Points to check with possible solutions
<p><b>3. The image vibrates on the screen.</b></p>	<ul style="list-style-type: none"> <li><input type="checkbox"/> Check that the signal cable is correctly connected to the PC or graphics board.</li> <li><input type="checkbox"/> The monitor may be located close to a device that is generating a magnetic field. Such devices include speakers (other than the EIZO optional <i>i</i>-Sound speaker), electric motors, high-voltage cables, and other monitors. It may be solved by turning off or moving the interfering device, or by relocating the monitor.</li> <li><input type="checkbox"/> Use of the &lt;Moiré Reduction&gt; adjustment may cause a slight vibration. To eliminate the vibration, set the adjustment level to lower percentage or 0%.</li> <li><input type="checkbox"/> If the volume level of the EIZO optional <i>i</i>-Sound speaker is too high, it may, in some cases, cause a slight vibration. To eliminate, turn down the volume of the speaker.</li> </ul>
<p><b>4. The image is flickering.</b></p>	<ul style="list-style-type: none"> <li><input type="checkbox"/> Flicker will occur with interlaced scanning or non-interlaced scanning with a low refresh rate. All EIZO monitors are capable of reproducing high refresh rates for non-interlaced scanning. If a problem occurs when using a non-interlaced signal, try adjusting the graphics board to increased the refresh rate (if possible). Refer to the graphics board manual for information.</li> </ul>
<p><b>5. Moiré patterns appear.</b></p> 	<ul style="list-style-type: none"> <li><input type="checkbox"/> Reduce the moiré using the &lt;Moiré Reduction&gt;.</li> <li><input type="checkbox"/> Change the horizontal and vertical size of the display area.</li> <li><input type="checkbox"/> Change the selected desktop or wallpaper pattern to any solid color pattern. For detailed information in how to change these patterns, refer to the PC and operating system manual.</li> </ul>

Problems	Points to check with possible solutions
<p><b>6. The entire screen appears too dark or bright.</b></p>	<ul style="list-style-type: none"> <li><input type="checkbox"/> Adjust the &lt;Contrast&gt; (Contrast and Brightness).</li> <li><input type="checkbox"/> Try changing the setting of the fine contrast mode. (p. 15)</li> <li><input type="checkbox"/> Video Signal level from the PC may not match the monitor. Set the video signal level using the ScreenManager.</li> <li><input type="checkbox"/> Turn off the monitor, then hold down the down arrow key while turning on the monitor again. Some signal timing can be the cause of this problem. This will change the signal timing and brighten the screen. If the above operation is repeated, the screen becomes dark again.</li> <li><input type="checkbox"/> Execute the &lt;Color Restoration&gt;. (p. 16)</li> </ul>
<p><b>7. Color is abnormal.</b></p> <ul style="list-style-type: none"> <li>• The entire screen appears bluish or reddish.</li> <li>• Color purity is not uniform.</li> <li>• Misconvergence of colors (red, green, blue)</li> </ul>	<ul style="list-style-type: none"> <li><input type="checkbox"/> When the monitor is not fully warmed up, the screen may look slightly colored, e.g. bluish or reddish. This phenomenon is due to the unstableness of the electron gun during its warm-up period. Wait for about 30 minutes until the monitor stabilizes in order to gain its proper color.</li> <li><input type="checkbox"/> Adjust the &lt;Degauss&gt;.</li> <li><input type="checkbox"/> Return the factory default setting by using &lt;Reset&gt;. Note that all the ScreenManager parameters will be returned to the factory default settings. (p. 28)</li> <li><input type="checkbox"/> Try adjusting the &lt;Convergence&gt;. The &lt;Convergence&gt; function adjusts the entire screen. It is not possible to limit adjustment to specific screen areas.</li> <li><input type="checkbox"/> Execute the &lt;Color Restoration&gt;. (p. 16)</li> </ul>
<p><b>8. &lt;Color Restoration&gt; does not work properly.</b></p>	<ul style="list-style-type: none"> <li><input type="checkbox"/> Allow the monitor to stabilize for at least 60 minutes before executing this function. Otherwise, the warning message "Still Warming Up! xx minutes remain" will appear on the screen. (p. 16)</li> </ul>
<p><b>9. ScreenManager or AUTO/FINE MODE button does not operate.</b></p>	<ul style="list-style-type: none"> <li><input type="checkbox"/> The Adjustment Lock is probably on. To unlock: Turn off the monitor power, then hold down the AUTO/FINE MODE button once again and turn the power back on. (p. 19)</li> </ul>

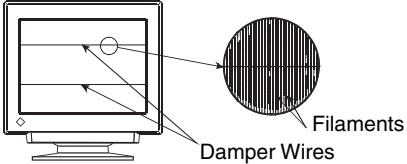
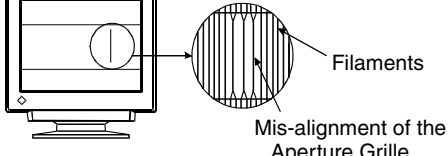
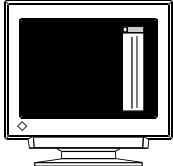
Problems	Points to check with possible solutions
<p><b>10. The Auto sizing function does not work properly.</b></p>	<ul style="list-style-type: none"> <li><input type="checkbox"/> The Auto sizing function is intended for use on the Macintosh and on AT-compatible PC running Windows. It may not work properly in either of the following cases. You are running an AT-compatible PC on MS-DOS (Not windows). The background color for the "wall paper" or "desktop" pattern is set to black.</li> <li><input type="checkbox"/> Some signals from graphics card may not function properly.</li> </ul>
<p><b>11. Two horizontal hairlines are visible on the screen.</b></p> 	<ul style="list-style-type: none"> <li><input type="checkbox"/> These are damper wires. Damper wires are used to support the CRT's aperture grille, and are visible as thin dark lines across the screen. All EIZO aperture grille type CRTs include two such horizontal wires. The aperture grille itself is a grid of taut metal filaments that spans the entire screen from top to bottom.</li> </ul>
<p><b>12. Faint black vertical lines are visible on the screen.</b></p>  	<ul style="list-style-type: none"> <li><input type="checkbox"/> The aperture grille may be misaligned. Shock or vibration during transport may, in some cases, cause the aperture grille to fall out of alignment. The problem will appear as one or more faint black lines across the screen. If this problem occurs, it may be solved by: <ol style="list-style-type: none"> <li>1. Degaussing the screen.</li> <li>2. Lightly tapping (do not hit) the side of the monitor.</li> </ol> </li> <li><input type="checkbox"/> If neither of these methods works, try executing the following procedure. <ol style="list-style-type: none"> <li>1. Display a bright white field over the area where the black line(s) appear, with a black field over the unaffected areas. (Do this by opening a bright-white window on top of a black desktop or wallpaper background. Position the window so that it just covers the area of misalignment.) (Refer to left figure)</li> <li>2. Set brightness and contrast to maximum values, and keep the display ON until the problem is corrected.</li> <li>3. Try tapping the side of the display lightly to help expedite realignment. The white field will heat up the misaligned area of the grille, returning it to proper alignment.</li> </ol> </li> </ul>



---

Problems	Points to check with possible solutions
<b>13. USB Function cannot be setup</b>	<ul style="list-style-type: none"><li data-bbox="659 204 1251 237">❑ Check that the USB cable is correctly connected.</li><li data-bbox="659 243 1251 334">❑ Check that the PC and USB compliant. (Please consult the manufacturer of each device about USB support.)</li><li data-bbox="659 340 1251 430">❑ When using the Windows 98 or later, check the BIOS setting of the PC for the USB. (Refer to the PC manual for details.)</li></ul>

# 5. CLEANING

Periodic cleaning is recommended to keep the monitor looking new and to prolong its operational lifetime. Clean the cabinet and CRT areas as follows:

## **NOTE**

- Never use thinner, benzene, alcohol (ethanol, methanol, or isopropyl alcohol), abrasive cleaners, or other strong solvents, as these may cause damage to the cabinet or CRT.

## **Cabinet**

To remove stains, wipe the cabinet with a soft, lightly moistened cloth using a mild detergent. Do not spray wax or cleaner directly onto the cabinet.

## **CRT Surface**

- The CRT surface can be cleaned with a soft cloth, such as cotton or lens paper.
- If necessary, use a moist cloth to remove stubborn stains.

# 6. SPECIFICATIONS

CRT		45 cm (17 inch) class, 90° deflection Tension Mask with Anti-Reflective SuperErgoCoat®, 0.25 mm AG Pitch
Horizontal Scan Frequency		30 kHz – 96 kHz (Automatic)
Vertical Scan Frequency		50 Hz – 160 Hz (Automatic)
Recommended Resolution		1280 dots x 1024 lines
Max .Active Display Area <sup>*1</sup>		316 mm (H) x 237 mm (V) (12.4 (H) x 9.3 (V)) Viewable image size: 403 mm (15.9")
Power Supply		100-120/200-240 VAC ± 10%, 50/60 Hz, 1.35 A/0.7 A
Power Consumption		Normal/Max: 110 W/ 130 W** (**With EIZO optional speaker) PowerManager Mode 1: Less than 10 W PowerManager Mode 2: Less than 3 W
Input Connector		D-Sub mini 15 pin connector and BNCx 5 (switchable)
Input Signal	Sync	a) Separate, TTL, Positive/Negative b) Composite, TTL, Positive/Negative c) Sync on Green, 0.3 Vp-p, Negative
Input Signal	Video	Analog 0.7 Vp-p/75 Ω, Positive
Signal registration		20 signals (Factory preset 2 modes)
Plug & Play		VESA DDC 2B
Dimensions		410mm (W) x 413 mm (H) x 439 mm (D) (16.1" (W) x 16.3" (H) x 17.3" (D))
Weight		19.5 kg (43.0 lbs.)
Temperature		Operating: 0 °C ~ 35 °C (32 °F to 95 °F) Storage: -20 °C ~ 60 °C (-4 °F to 140 °F)
Humidity		30% to 80 % R.H. Non-condensing
Certifications and Standards		
100-120 VAC		UL/C-UL, FCC-B, DHHS, TCO '99 <sup>*2</sup> , EPA ENERGY STAR® Program
200-240 VAC		CE, CB, TÜV Rheinland/GS, TCO '99 <sup>*2</sup> , EPA ENERGY STAR® Program, TÜV Eco Circle 2001

<sup>\*1</sup> Display size can be set by the user through microprocessor control panel. The actual size displayed can be dependent on the graphics board or PC utilized.

<sup>\*2</sup> Applicable to gray (standard) color version only.

### Factory Defaults

Contrast	100%/50%
Moiré Reduction	0%
Video Label	0.7
Color Mode/Temperature	Standard/9300K
PowerManager	On
Off Timer	Disable
Input Priority	Auto D-Sub
Fine Contrast	Text
Movie Mode	Movie 1

### Preset Timing

	Resolution	Horizontal frequency (kHz)	Vertical frequency (kHz)	Interlace	Sync Polarity		Video Signal level
					H	V	
VGA (Text)	640 x 480	31.47	59.94	Non	Negative	Negative	Analog 0.7 Vp-p/75 Ω
VESA	1280 x 1024	91.15	85.02	Non	Positive	Positive	Analog 0.7 Vp-p/75 Ω

### Dimensions

mm  
(inches)

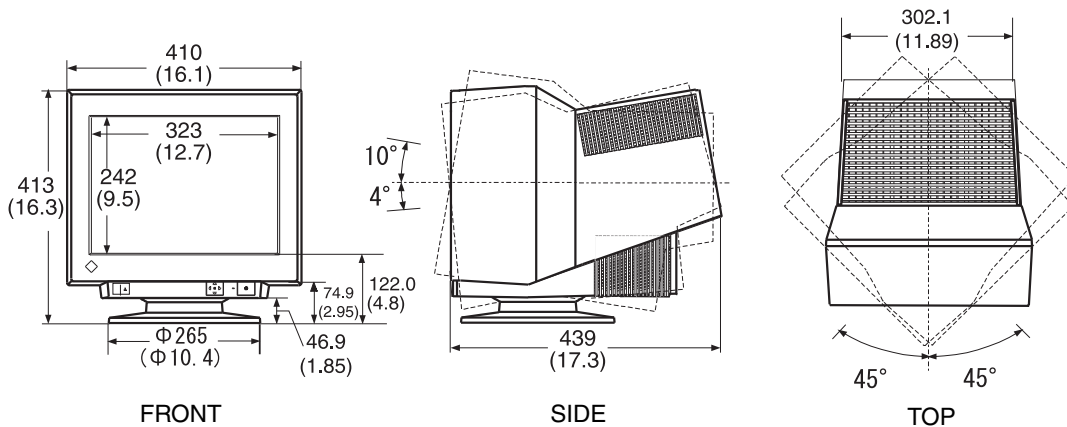

## Pin Assignment

### D-Sub mini 15 pin connector

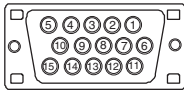

No.	Signal	No.	Signal	No.	Signal
1	Red Video	6	Red ground	11	Ground (shorted with 10 pin)
2	Green Video / Green composite sync	7	Green ground	12	Data (SDA)
3	Blue video	8	Blue ground	13	H.Sync / HV composite Sync
4	Ground	9	-	14	V.Sync
5	-	10	Ground	15	Clock (SCL)

### BNC-Connector

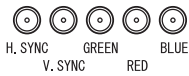

Connector Input signal	H.Sync	V.Sync	Green	Red	Blue
Separate sync	H.Sync	V.Sync	Green	Red	Blue
Composite sync	H/V composite sync	N/A	Green	Red	Blue
Sync on Green	N/A	N/A	Green Composite sync	Red	Blue

# 7. GLOSSARY

## Color Temperature

Color temperature is a method to measure the white color tone, generally indicated in degrees Kelvin. At high temperatures the white tone appears somewhat blue, while at lower temperatures it appears somewhat red. Computer monitors generally give best performance at high temperature settings.

5,000K: Often used in printing industry.

6,500K: Good for video-image display.

9,300K: Default setting for your EIZO monitor.

## Cutoff and Gain

All colors displayed on the screen are produced by the combination of the light's three primary colors, red, green, and blue. For example, white will be displayed when the amount of luminescence of red, green and blue is at the almost same rate.

Theoretically, black will be displayed when red, green and blue don't emit light at all. However, actually, on the screen the amount of luminescence of each color is not zero and each color emits light slightly. The luminosity of each color at this time is called cutoff (Black level), and the luminosity of each color on the basis of the cutoff is called gain.

## Convergence

Convergence is the monitor's ability to precisely illuminate specific phosphors and line them up properly in order to produce pure color.

## Degaussing

"Degaussing" refers to the process of removing magnetic-field effects from the monitor. Operation of the monitor within a magnetic field may adversely effect color purity. Degaussing can be used to correct the problem.

## Moiré Reduction

Moiré refers to an interference pattern of dark wavy lines on the screen. It is not a defect, but rather an interference phenomenon caused by the relationship between the phosphor layout and the imaging signal. Moiré is often an indication of a good focus level. Moiré is particularly noticeable when using a light-gray or every-other-dot pattern background. Although moiré cannot be eliminated, it can be reduced with the moiré reduction feature.

**Resolution**

Resolution is expressed as the number of dots (pixels) displayed on the screen.

A larger number of dots produces a more sharply defined (a higher-resolution) image. Note that for a given screen size the dot size decreases as the number of dots increases: a 640 x 480 (dot x line) resolution uses larger pixels than a 1024 x 768 resolution. The display size of a given font therefore varies according to the resolution. Higher resolutions allow you to display more information on the screen.

**sRGB (Standard RGB)**

"International Standard for Red, Green, and Blue color space" A color space was defined with the aim of the color matching between applications and hardware devices, such as monitors, scanners, printers and digital cameras. As a standard default space, sRGB allows Internet users to closely match colors.

**VESA DPMS**

The acronym VESA stands for "Video Electronics Standards Association," and DPMS stands for "Display Power Management Signaling." DPMS is a communication standard that PCs and graphics boards use to implement power savings on the monitor side.

[Applicable to gray (standard color version only).]



### **Congratulations!**

You have just purchased a TCO'99 approved and labelled product! Your choice has provided you with a product developed for professional use. Your purchase has also contributed to reducing the burden on the environment and also to the further development of environmentally adapted electronics products.

### **Why do we have environmentally labelled computers?**

In many countries, environmental labelling has become an established method for encouraging the adaptation of goods and services to the environment. The main problem, as far as computers and other electronics equipment are concerned, is that environmentally harmful substances are used both in the products and during their manufacture. Since it is not so far possible to satisfactorily recycle the majority of electronics equipment, most of these potentially damaging substances sooner or later enter nature.

There are also other characteristics of a computer, such as energy consumption levels, that are important from the viewpoints of both the work (internal) and natural (external) environments. Since all methods of electricity generation have a negative effect on the environment (e.g. acidic and climate-influencing emissions, radioactive waste), it is vital to save energy. Electronics equipment in offices is often left running continuously and thereby consumes a lot of energy.

### **What does labelling involve?**

This product meets the requirements for the TCO'99 scheme which provides for international and environmental labelling of personal computers. The labelling scheme was developed as a joint effort by the TCO (The Swedish Confederation of Professional Employees), Svenska Naturskyddsforeningen (The Swedish Society for Nature Conservation) and Statens Energimyndighet (The Swedish National Energy Administration).

Approval requirements cover a wide range of issues: environment, ergonomics, usability, emission of electric and magnetic fields, energy consumption and electrical and fire safety.

The environmental demands impose restrictions on the presence and use of heavy metals, brominated and chlorinated flame retardants, CFCs (freons) and chlorinated solvents, among other things. The product must be prepared for recycling and the manufacturer is obliged to have an environmental policy which must be adhered to in each country where the company implements its operational policy.

The energy requirements include a demand that the computer and/or display, after a certain period of inactivity, shall reduce its power consumption to a lower level in one or more stages. The length of time to reactivate the computer shall be reasonable for the user.

Labelled products must meet strict environmental demands, for example, in respect of the reduction of electric and magnetic fields, physical and visual ergonomics and good usability.

You will find a brief summary of the environmental requirements met by this product on the right. The complete environmental criteria document may be ordered from:

TCO Development

SE-114 94 Stockholm, Sweden

Fax: +46 8 782 92 07

Email (Internet): [development@tco.se](mailto:development@tco.se)

Current information regarding TCO'99 approved and labelled products may also be obtained via the Internet, using the address: <http://www.tco-info.com/>



## **Environmental Requirements**

### **Flame retardants**

Flame retardants are present in printed circuit boards, cables, wires, casings and housings. Their purpose is to prevent, or at least to delay the spread of fire. Up to 30% of the plastic in a computer casing can consist of flame retardant substances. Most flame retardants contain bromine or chloride, and those flame retardants are chemically related to another group of environmental toxins, PCBs. Both the flame retardants containing bromine or chloride and the PCBs are suspected of giving rise to severe health effects, including reproductive damage in fish-eating birds and mammals, due to the bio-accumulative\* processes. Flame retardants have been found in human blood and researchers fear that disturbances in foetus development may occur.

The relevant TCO'99 demand requires that plastic components weighing more than 25 grams must not contain flame retardants with organically bound bromine or chlorine. Flame retardants are allowed in the printed circuit boards since no substitutes are available.

### **Cadmium\*\***

Cadmium is present in rechargeable batteries and in the colour-generating layers of certain computer displays. Cadmium damages the nervous system and is toxic in high doses.

The relevant TCO'99 requirement states that batteries, the colour-generating layers of display screens and the electrical or electronics components must not contain any cadmium.

### **Mercury\*\***

Mercury is sometimes found in batteries, relays and switches. It damages the nervous system and is toxic in high doses.

The relevant TCO'99 requirement states that batteries may not contain any mercury. It also demands that mercury is not present in any of the electrical or electronics components associated with the labelled unit.

### **CFCs (freons)**

The relevant TCO'99 requirement states that neither CFCs nor HCFCs may be used during the manufacture and assembly of the product. CFCs (freons) are sometimes used for washing printed circuit boards. CFCs break down ozone and thereby damage the ozone layer in the stratosphere, causing increased reception on earth of ultraviolet light with e.g. increased risks of skin cancer (malignant melanoma) as a consequence.

### **Lead\*\***

Lead can be found in picture tubes, display screens, solders and capacitors. Lead damages the nervous system and in higher doses, causes lead poisoning.

The relevant TCO'99 requirement permits the inclusion of lead since no replacement has yet been developed.

\* Bio-accumulative is defined as substances which accumulate within living organisms.

\*\* Lead, Cadmium and Mercury are heavy metals which are Bio-accumulative.

For U.S.A, Canada, etc. (rated 100-120 Vac) Only

---

## FCC Declaration of Conformity

We, the Responsible Party

EIZO NANA O TECHNOLOGIES INC.  
5710 Warland Drive, Cypress, CA 90630  
Phone: (562) 431-5011

declare that the product

Trade name: EIZO  
Model: FlexScan T566

is in conformity with Part 15 of the FCC Rules. Operation of this product is subject to the following two conditions: (1) this device may not cause harmful interference, and (2) this device must accept any interference received, including interference that may cause undesired operation.

This equipment has been tested and found to comply with the limits for a Class B digital device, pursuant to Part 15 of the FCC Rules. These limits are designed to provide reasonable protection against harmful interference in a residential installation. This equipment generates, uses, and can radiate radio frequency energy and, if not installed and used in accordance with the instructions, may cause harmful interference to radio communications. However, there is no guarantee that interference will not occur in a particular installation. If this equipment does cause harmful interference to radio or television reception, which can be determined by turning the equipment off and on, the user is encouraged to try to correct the interference by one or more of the following measures.

- \* Reorient or relocate the receiving antenna.
- \* Increase the separation between the equipment and receiver.
- \* Connect the equipment into an outlet on a circuit different from that to which the receiver is connected.
- \* Consult the dealer or an experienced radio/TV technician for help.

Changes or modifications not expressly approved by the party responsible for compliance could void the user's authority to operate the equipment.

### Note

Use the attached specified cable below or EIZO signal cable with this monitor so as to keep interference within the limits of a Class B digital device.

- AC Cord
- Shielded Signal Cable (enclosed)

---

## Canadian Notice

This Class B digital apparatus complies with Canadian ICES-003.

Cet appareil numérique de la classe B est conforme à la norme NMB-003 du Canada.

**Hinweis zur Ergonomie :**

Dieser Monitor erfüllt die Anforderungen an die Ergonomie nach EK1-ITB 2000 mit dem Videosignal, 1280 Punkte × 1024 Zeilen, RGB analog, 0,7 Vp-p und mindestens 85,0 Hz Bildwiederholfrequenz, non interlaced. Weiterhin wird aus ergonomischen Gründen empfohlen, die Grundfarbe Blau nicht auf dunklem Untergrund zu verwenden (schlechte Erkennbarkeit, Augenbelastung bei zu geringem Zeichenkontrast.)

**Recycle Auskunft**

Die Rücknahme dieses Produktes nach Nutzungsende übernimmt EIZO in Deutschland zusammen mit dem Partner von Roll MBB Recycling GmbH. Dort werden die Geräte in ihre Bestandteile zerlegt, die dann der Wiederverwertung zugeführt werden. Um einen Abholtermin zu vereinbaren und die aktuellen Kosten zu erfahren, benutzen Sie bitte folgende Rufnummer: 02153-73 35 00. Weitere Informationen finden Sie auch unter der Internet-Adresse: [www.eizo.de](http://www.eizo.de).

**Hinweis**

Die boldröhre dieses Monitors ist frei von Cadmium.



**EIZO NANAO CORPORATION**

153 Shimokashiwano, Matto, Ishikawa 924-8566 Japan  
Phone: +81 76 277 6792 Fax: +81 76 277 6793

**EIZO NANAO TECHNOLOGIES INC.**

5710 Warland Drive, Cypress, CA 90630  
Phone: +1 562 431 5011 Fax: +1 562 431 4811

<http://www.eizo.com/>

First Edition-April, 2002

Version A  
(MA-1798-EU)