

User's Manual

FlexScan[®] F730

Color Display Monitor



CONTENTS



PRECAUTIONS 3

INTRODUCTION 7

About This Manual 7

Controls & Connectors 7

Package Contents 7

1 INSTALLATION 8

1-1 Connecting the Monitor to the PC 8

1-2 Using the AUTO-SIZING Button 10

1-3 Setting the Resolution 10

2 SCREEN ADJUSTMENT 11

2-1 How to Use the ScreenManager 11

2-2 Adjustments and Settings 11

2-3 Shortcut Keys 18

2-4 Adjustment Lock 18

3 TROUBLESHOOTING 19

4 CLEANING 23

5 SPECIFICATIONS 24

Copyright© 2001 by EIZO NANAO CORPORATION. All rights reserved. No part of this manual may be reproduced, stored in a retrieval system, or transmitted, in any form or by any means, electronic, mechanical, or otherwise, without the prior written permission of Eizo Nanao Corporation.

Eizo Nanao Corporation is under no obligation to hold any submitted material or information confidential unless prior arrangements are made pursuant to Eizo Nanao Corporation's receipt of said information.

Although every effort has been made to ensure that this manual provides up-to-date information, please note that EIZO monitor specifications are subject to change without notice.

ENERGY STAR is a U.S. registered mark.

Apple and Macintosh are registered trademarks of Apple Computer, Inc.

VGA is a registered trademark of International Business Machines Corporation.

DPMS is a trademark and VESA is a registered trademark of Video Electronics Standards Association.

Windows is registered trademark of Microsoft Corporation.

ScreenManager, PowerManager, QuickSet, i-Sound and i-Station are trademarks of Eizo Nanano Corporation.

FlexScan, SuperErgoCoat and EIZO are registered trademarks of Eizo Nanao Corporation.

PRECAUTIONS

IMPORTANT!

- * This product has been adjusted specifically for use in the region to which it was originally shipped. The performance of the product, (i.e. picture geometry, picture positioning and color convergence and purity in the case of color monitors) is optimally adjusted to the earth's magnetic field of the specific destination. If operated outside the region to which it was originally shipped, the product may not perform as stated in the specifications.
- * The manufacturer is not responsible for damage or malfunction caused by improper connection. The power cord should be connected directly to a standard wall power outlet.

Location of the Caution Statements

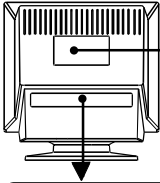

The equipment must be connected to a grounded main outlet.
Jordet stikkontakt skal benyttes når apparatet tilkobles datanett.
Apparaten skall anslutas till jordat nätuttag.
電源コードのアースは必ず接地してください。

| | | | | | |
|--|--|--|--|---|--|
| | <p>警告 高压注意 サービスマン以外の人は裏ぶたを あけないでください。 内部には高電圧部分が多くあり、 万一さわると危険です。</p> | <p>CAUTION RISK OF ELECTRIC SHOCK. DO NOT OPEN.</p> | <p>ATTENTION RISQUE DE CHOC ELECTRIQUE. NE PAS OUVRIIR.</p> | <p>ACHTUNG GEFAHR DES ELEKTRISCHEN SCHLAGES. RÜCKWAND NICHT ENTFERNEN.</p> | |
|--|--|--|--|---|--|

IMPORTANT!

To ensure personal safety and proper maintenance. Please read this section and the caution statements on the monitor (refer to the figure above).

This manual uses the safety symbols below. They denote critical information.

Please read them carefully.



Indicates a prohibited action.



Indicates to ground for safety.



WARNING

Failure to abide by the information in a WARNING may result in serious injury and can be life threatening.



CAUTION

Failure to abide by the information in a CAUTION may result in moderate injury and/or property or product damage.

 **WARNING**

- **If the monitor begins to emit smoke, smells like something is burning, or makes strange noises, disconnect all power connections immediately and contact your dealer for advice.**

Attempting to use a malfunctioning monitor can be dangerous.

- **Do not dismantle the cabinet or modify the monitor.**

Dismantling the cabinet or modifying the monitor may result in electric shock or burn.

- **Keep small objects away from the monitor.**

Small objects may accidentally fall through the ventilation slots into the cabinet, leading to fire, shock, or equipment damage.

- **Keep liquids away from the monitor.**

Spillage into the cabinet may result in fire, electric shock, or equipment damage. If an object or liquid falls/spills into the cabinet, unplug the monitor immediately. Have the unit checked by a qualified service engineer before using it again.

- **Place the monitor on a strong, stable surface.**

A unit placed on an inadequate surface may fall, resulting in injury or equipment damage. If the monitor falls, disconnect the power immediately and have the unit checked by a qualified service engineer before using it again. Using a monitor after it has been dropped may result in fire or electric shock.

- **Keep the plastic packing bags away from children and infants.**

Plastic bags can be dangerous. To avoid danger of suffocation, keep the bag away from babies and children.

- **Keep power terminal covers for the optional *i-Sound*[®] sound unit away from children and infants.**

Children and infants may accidentally swallow the covers and choke. If swallowed, consult a doctor immediately.

- **Use the enclosed power cord. If using the power cord other than the enclosed one, use the following cord.**

In USA and Canada, use a UL LISTED/CSA LABELED or CERTIFIED power cord set meeting the following specifications.

* Rating: min. 125 V, 10 A * Length: max. 2.0 m

* Type: SVT

* Plug type: NEMA 5-15P, Parallel blade, Grounding type, 125 V, 10 A

In Europe, use a proper European standard approved power cord meeting the following specifications.

* Rating: min. 250 V, 10 A * Length: max. 2.0 m

* Type: H05VV-F 3G 1 mm²

Use a plug type approved by the country where you use

Failure to do so may cause fire or electric shock.

- **The equipment must be connected to a grounded main outlet.**

- **Use the correct voltage.**

The monitor is designed for use with a specific voltage only. Connection to a different voltage may cause fire, electric shock, or other damage.

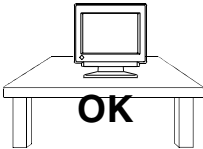



- **Do not overload your power circuit, as this may result in fire or electric shock.**
- **For proper connections of the power cord, be certain to plug the power cord to the provided monitor connector and directly to a wall outlet.**

By not doing so may result in fire or electric shock.



- **Handle the power cord with care.**

- * Do not place the cord underneath the monitor or other heavy objects.
- * Do not pull on the cord.
- * Do not attempt to repair a damaged cord.

If the power cord becomes damaged, stop using it. Use of a damaged cord may result in fire or electric shock.



- **To disconnect the power cord, grasp the plug firmly and pull.**

Never tug on the cord, doing so may cause damage and could result in fire or electric shock.

CAUTION

- **Disconnect the power cord, signal cables and remove the optional i-Sound[®] sound unit and i-Station[®] USB hub (if applicable) when moving the monitor.**

Moving the monitor with the cord attached or lifting it by the i-Sound sound unit or i-Station USB hub is dangerous. It may result in injury or equipment damage.



- **Handle with care when carrying the monitor**

Note that the monitor is heavier at the front than at the rear. Do not move it alone. Always work with another person.

The screen is optically coated to reduce glare. Keep hard objects (such as buttons, tie pins, and other clothing accessories) away from the screen surface to prevent scratches.



- **Set the monitor in an appropriate location.**

- * Do not install in a dusty or humid environment.
- * Do not place in a location where light shines directly on the screen.
- * Do not place near heat generating devices or a humidifier.



- **Use an easily accessible power outlet.**

This will ensure that you can disconnect the power quickly in case of a problem.

- **Do not sit on the cabinet or place any heavy objects on the cabinet.**

A unit with heavy objects on it may fall or be damaged and result in injury.

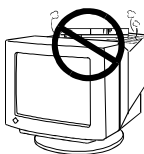

- **Do not block the ventilation slots on the cabinet.**

- * Do not place books or any other papers on the ventilation slots.
- * Do not install the monitor in a closed space.
- * Do not use the monitor laying down or upside down.
- * Do not remove the tilt-swivel stand.

Using the monitor in this way blocks the ventilation slots and prevents proper airflow, leading to fire or other damage.

-
- **Do not remove the tilt-swivel stand.**

The stand is required to maintain clearance for the ventilation slots on the bottom of the cabinet. Removing the stand will block these slots and may result in fire or electric shock.



- **Do not touch the plug with wet hands.**

Touching the plug with wet hands is dangerous and can cause electrical shock.

- **At the end of the day or if you plan to leave the monitor unused for an extended period, after turning off the power switch disconnect the power cord from the wall socket so that no power connections are made.**

- **Unplug the monitor before cleaning it.**

Cleaning the monitor while it is plugged into a power outlet may result in electric shock.

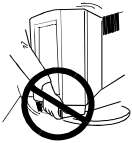

- **When adjusting the viewing angle of the monitor, do not do so by handling the sound unit or USB hub (if applicable).**

Adjusting the monitor in this way may break the unit or cause bodily injury.

Others

- Do not install the monitor within an area subject to strong magnetic fields (for example, in the vicinity of a speaker, except the optional *i*-Sound unit, or a high-voltage transformer). Magnetic fields can cause noise, image shaking, and other distortions.

Generally, for maximum viewing comfort position the monitor slightly below eye level. Staring at the monitor for prolonged periods can cause eye strain. Be sure to take adequate rests. (A 10-minute rest period each hour is suggested.)

- Do not remove the covers to the power terminal for the optional *i*-Sound speaker unit for any reason except to attach the unit.

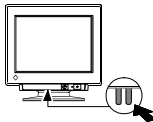
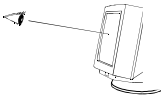
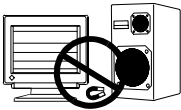

INTRODUCTION

About This Manual

This manual explains the precautions, specifications, and operation of your EIZO monitor. Please read through this manual as it will help you to get the most out of your monitor.

Controls & Connectors:

Front

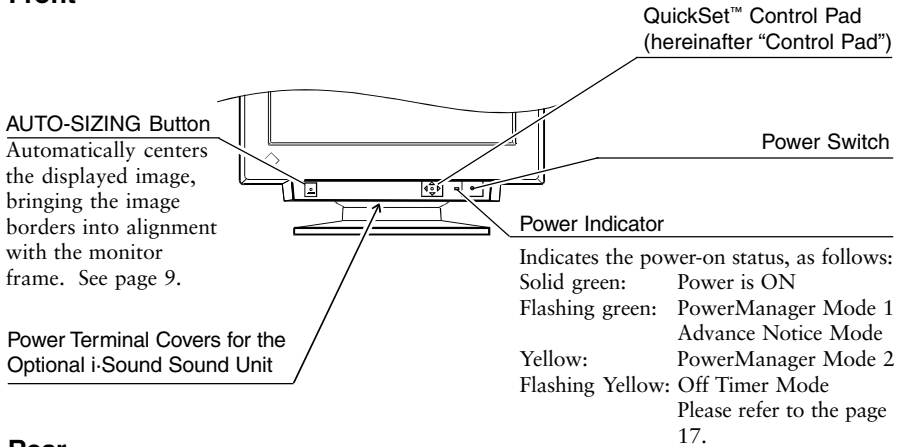

Rear

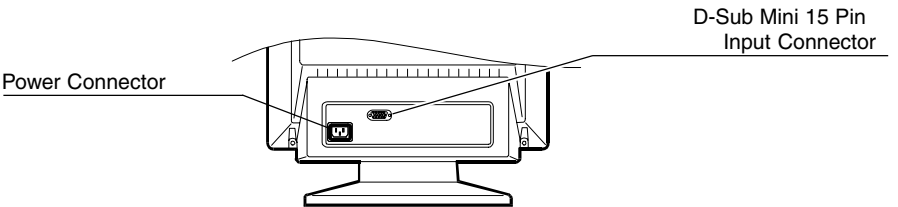

Package Contents:

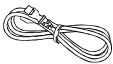

Power Cord



EIZO CRT
Utility Disk

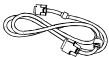

Signal Cable
(MD-C87/
MD-C100)



Warranty
Registration
Card



User's Manual

NOTE

- If any of the above-listed items are missing or damaged, please contact your local dealer for assistance.

1 INSTALLATION

1-1. Connecting the monitor to the PC

- 1) Be sure that the power switches of both the PC and the monitor are OFF.
- 2) Plug the signal cable into the connector at the rear of the monitor.

NOTE

- When connecting the signal cable or cable adapter, first check that the shape at the cable side matches the shape at the connecting side. After connecting, secure the connection with the screw-in fasteners.
- 3) Plug the other end of the cable into the video connector on the rear of the PC.

■ Standard PC graphics board

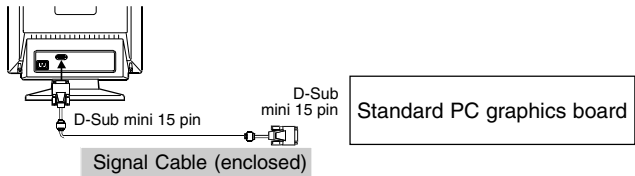

Using the monitor with Windows 95/98

A monitor information file is in the EIZO CRT Utility disk enclosed with the package. It includes all the required information for best operation with Windows 95/98.

Install the enclosed utility and select your model name from the monitor list in Windows 95/98. For installation procedure, read the Readme file in the utility disk.

■ Macintosh

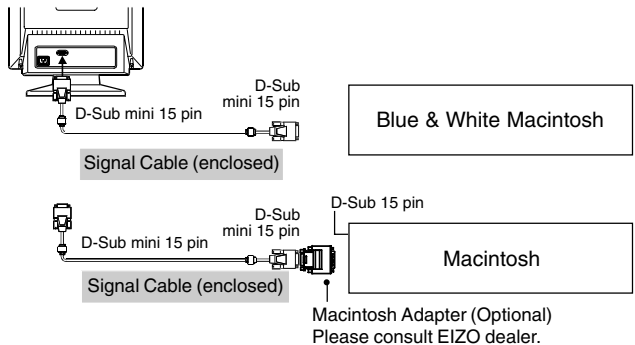

- 4) Plug the power cord into the power connector at the rear of the monitor. Then plug the other end of the cord into a power outlet.

 **WARNING**

- **Use the enclosed power cord. If using the power cord other than the enclosed one, use the following cord.**

In USA and Canada, use a UL LISTED/CSA LABELED or CERTIFIED power cord set meeting the following specifications:

- * Rating: min. 125 V, 10 A
- * Length: max. 2.0 m
- * Type: SVT
- * Plug type: NEMA 5-15P, Parallel blade, Grounding type, 125 V, 10 A

In Europe, use a proper European standard approved power cord meeting the following specifications:

- * Rating: min. 250 V, 10 A
- * Length: max. 2.0 m
- * Type: H05VV-F 3G 1 mm²

Use a plug type approved by the country where you use

Failure to do so may cause fire or electric shock.

- 5) Turn on the monitor first, then the PC. The monitor's power indicator will light up (green). The monitor will warm up briefly, then display an image. Whenever finishing your operation, turn off the PC and the monitor.

NOTE

- If an image does not appear, refer to the "TROUBLESHOOTING" section on page 19 for an advice.

1-2. Using the AUTO-SIZING Button

After connecting the monitor to the PC, first press the AUTO-SIZING button on the front panel. The AUTO-SIZING function centers the displayed image, aligning the image's borders with respect to the monitor frame.

In general, press the AUTO-SIZING button whenever changing the graphics board to the resolution or when image size and/or position is incorrect.

If further adjustment is required, adjust the picture size/position as desired using the Size/Position function in the ScreenManager. Refer to page 11.

NOTE

- Some signals from the graphics board may not function properly.
- A solid-color screen (i.e. red, green, blue) may appear for an instant while performing the AUTO-SIZING function, while this phenomenon is not a failure.

1-3. Setting the resolution

The following look-up table shows the maximum (Non-interlaced) vertical refresh rates for this model with regard to *standard resolutions set forth by VESA*. The best way to see if the monitor will work with a given resolution and rate, is to compare the vertical refresh rate of the graphics board to the monitor's range (Refer to the graphics board manual for specifications). If the refresh rate is within the specified range of the monitor, it should operate properly.

| Horizontal Scan Frequency (kHz) | Maximum Vertical Refresh rate (Hz) | | | | | |
|---------------------------------|------------------------------------|---------|----------|-----------|-----------|-----------|
| | 640x480 | 800x600 | 1024x768 | 1280x1024 | 1600x1200 | 1600x1280 |
| 30-115 | 160 | 160 | 142 | 107 | 92 | 86 |

What is Resolution?

Resolution is expressed as the number of dots (pixels) displayed on the screen. A larger number of dots produces a more sharply defined (a higher-resolution) image.

Note that for a given screen size the dot size decreases as the number of dots increases: a 640 x 480 (dot x line) resolution uses larger pixels than a 1024 x 768 resolution. The display size of a given font therefore varies according to the resolution. Higher resolutions allow you to display more information on the screen.

2 SCREEN ADJUSTMENT

2-1. How to use the ScreenManager

Entering the ScreenManager

Press the ENTER key to display the ScreenManager Main menu.

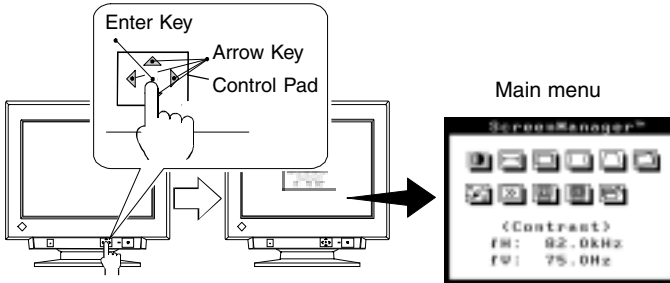

Making the Adjustments and Settings

- 1) Select the desired icon using the Arrow keys, and then press the ENTER key to display the each adjustment/setting menu.
- 2) Use the Control pad to make the required adjustments and settings.

Save & Exit

- 1) To save settings and return to the Main menu, press the ENTER key.
- 2) To exit the ScreenManager, select the Exit icon (or push the down Arrow key twice) and press the ENTER key.



NOTE

- Leaving the ScreenManager idle for 45 seconds or more will turn the adjusting off automatically, without the adjustment being saved.

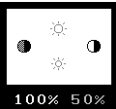

2-2. Adjustments and Settings

NOTE

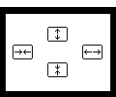
- Allow the monitor to stabilize for at least 30 minutes before making image adjustments.

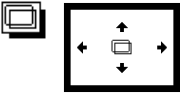
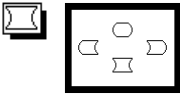
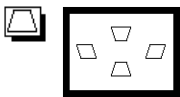
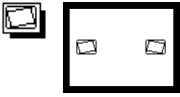
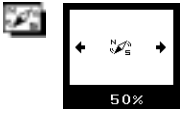
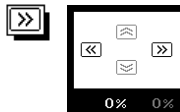

| | Function |
|--|--|
| Contrast/Brightness   | Adjusts: Contrast/Brightness • When a white text against a black background (e.g., DOS text) is used, setting the brightness at its maximum is recommended because a dark setting will result in eye strain due to high character contrast. |
| Size   | Adjusts: Horizontal Image Size/Vertical Image Size |

| | Function |
|---|--|
| Position  | Adjusts: Screen Position |
| Side-Pin Balance/ Side-Pincushion  | Adjusts: Side-pin Balance/Side-pincushion |
| Parallelogram/ Trapezoidal  | <ul style="list-style-type: none"> · Tilts: Image Sides to Sides · Expands: Top Side/Bottom Side, Shrinking the Other Side |
| Tilt  | Tilts: The Image |
| Uniformity  | Adjusts: Uniformity |
| Moiré  | Adjusts: Horizontal Moiré Adjusts: Vertical Moiré <div style="border: 1px solid black; padding: 5px;"> <p>What is moiré?</p> <p>Moiré refers to an interference pattern of dark wavy lines on the screen. It is not a defect, but rather an interference phenomenon caused by the relationship between the phosphor layout and the imaging signal. Moiré is often an indication of a good focus level. Moiré is particularly noticeable when using a light-gray or every-other-dot pattern background. Although moiré can not be eliminated, it can be reduced with the moiré reduction feature.</p> </div> |

| | Function |
|--|--|
| <p>Color</p>  | <ul style="list-style-type: none"> · Standard mode For routine work and printing. Temperature can be set from 6,500K to 10,000K, in 500K increments. (Additionally, industry standard of 9,300K is set as default.) · Custom mode For use when high precision color adjustment is necessary (i.e. when there is a need to obtain identical colors on multiple monitors* or match the display color with printout color**.) Color custom sets color temperature, allows for specific adjustments to Red, Green and Blue (R/G/B). This consists of the Cutoff and Gain functions. <p>Refer to the instruction below for details.</p> |
| <p>Others</p>  | <ul style="list-style-type: none"> · PowerManager · Signal Filter · Menu Position · Off Timer · Video Level · Reset <p>Refer to the page 16 for details.</p> |

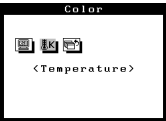
Color

| | Function |
|--|--|
| <p>Standard Mode</p>  | <p>Adjusts: Color Temperature</p> <div style="border: 1px solid black; padding: 5px;"> <p>What is color temperature?</p> <p>Color temperature is a method to measure the white color tone, generally indicated in degrees Kelvin. At high temperatures the white tone appears somewhat blue, while at lower temperatures it appears somewhat red. Computer monitors generally give best performance at high temperature settings.</p> <p>6,500K: This temperature is good for video-image display.</p> <p>9,300K: This is the default setting for your EIZO monitor.</p> </div> |

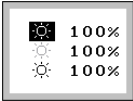
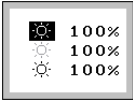

| | Function |
|---|--|
| <p>Custom Mode</p>  | <p>Adjusts: Color Temperature Gain Cutoff</p> <div style="border: 1px solid black; padding: 5px;"> <p>Cutoff and Gain adjustments</p> <p>Monitors use red, green and blue (R, G, and B) to convey color information. They use an additive method to combine different amounts of the primary colors to produce a desired color. In other words, monitors start with no light (black) and add percentages of red, green and blue to make colors. White is usually produced by adding the same amount of all three colors, where black is usually produced by adding no color.</p> <p>However, colors are not only determined by the balance but also the intensities of R, G, and B (how bright they are) which we call Gain, and the saturation of R, G and B (how vivid or dull they are) which we call Cutoff.</p> </div> <p>· If only a quick setting is required, that is close to the desired color, but not exact, skip making any changes to the Cutoff adjustment (step 4). If a precise match is desired, adjustment of the Cutoff levels must be made. We recommend that for exact matching, use a color calibrator.</p> <p>■ Set-up Procedure</p> <ol style="list-style-type: none"> (1) Set the monitor to maximum brightness and contrast. (2) Return to the “Color” menu and select the “Custom mode” setting. (3) Set the color temperature. (4) Adjust the Cutoff. (5) Adjust the Gain. (6) Select the “Save” icon and then pres the enter key. (7) Readjust the contrast in the Screen menu to get the best image clarity. |
| <p>Color Temperature (Custom Mode)</p>  | <p>Adjusts: Color Temperature</p> <ol style="list-style-type: none"> a) Select the “Temperature” icon from the sub menu. b) Select the temperature as desired by moving the arrow keys in any direction. |

| Function | |
|--|--|
| <p>Cutoff (Custom Mode)</p>  | <p>Adjusts: Cutoff</p> <p>Cutoff</p> <p>The Cutoff adjustment is the most powerful adjustment. It alters the starting point (the black level) and the ending point (the white level). If the Cutoff level for color is raised or lowered, black, white, and all levels between are raised or lowered by the same degree.</p> |
| <p>Gain (Custom Mode)</p>  | <p>Adjusts: Gain</p> <p>Gain</p> <p>The Gain adjustment has no effect on the starting point (the black level). It changes only the ending point (the white level). The Gain adjustment is used to fine tune the whites and light grays to a good balance.</p> |

NOTE

- If an inappropriate adjustment is made, corrections can be made by repeating the above procedure starting from Step 3 (temperature setting).
- The values shown in percentages (%) for both the Cutoff and Gain adjustments represent the current level within the specific adjustment only. They are available only as a reference tool. (To create a uniform white or black screen, the percentages for each will probably not be the same.)

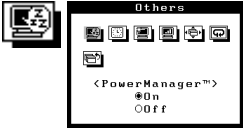

Others

| | Function |
|---|--|
| <p>VESA DPMS</p>  | <p>The PowerManager feature automatically reduces the monitor's power consumption during idle periods. The EIZO PowerManager functions comply with the VESA DPMS standard.</p> <ul style="list-style-type: none"> • Do your part to conserve energy, turn off the monitor when your finished using it. Complete energy use can only be stopped by disconnecting the monitor from the power supply. • When the monitor is in a power saving mode, the optional EIZO i-Sound speaker unit will turn off. • Off Timer will work while PowerManager is active, but there will be no advance notice before the monitor's power switches off. <div style="border: 1px solid black; padding: 5px; margin-top: 10px;"> <p>What is VESA DPMS?</p> <p>The acronym VESA stands for "Video Electronics Standards Association," and DPMS stands for "Display Power Management Signaling." DPMS is a communication standard that PCs and graphics boards use to implement power savings at the monitor side.</p> </div> <div style="border: 1px solid black; padding: 5px; margin-top: 10px;"> <p>What is ENERGY STAR?</p> <p>"ENERGY STAR" is a set of power saving guidelines issued by the U.S. Environmental Protection Agency (EPA). The guidelines apply to PC systems and peripherals.</p> <p> As an ENERGY STAR® Partner, Eizo Nanao Corporation has determined that this product meets the ENERGY STAR® guidelines for energy efficiency.</p> </div> <p>■ Set-up Procedure</p> <ol style="list-style-type: none"> 1) First, make the appropriate settings for the PC. 2) Select VESA DPMS icon in the ScreenManager's PowerManager menu. Select "On". |

■ Power saving method of VESA DPMS and the monitor

VESA DPMS utilizes four signals: ON, STAND-BY, SUSPEND, and OFF. The monitor detects these signals from the graphics board and executes power-saving accordingly, as shown in the table below.

| Signal | Screen | LED | Power consumption |
|----------|----------------|----------------|-------------------|
| ON | Operation | Green | 120 W (normal) |
| STAND-BY | Blank | Green | 80% of normal |
| SUSPEND | Blank (Mode 1) | Flashing green | less than 10 W |
| OFF | Blank (Mode 2) | Yellow | less than 3 W |

| | Function |
|---|--|
| <p>Off Timer</p>   | <p>What is Off Timer?</p> <p>The Off Timer function allows the user to set the time in which the monitor will be in operation, called the “On Period” and automatically shifts the operation into the “Off Timer Mode” when the set “On Period” expires. The energy consumption of the monitor in the “Off Timer Mode” is as low as the one of the monitor in “PowerManager Mode 2” although no setting PC to operate the Off Timer function is required.</p> |



■ Set-up Procedure

- 1) Select the “Off Timer” icon. Select “Enable” and press the enter key.
- 2) Press the right/left key to adjust how long (0 to 23 hours) the monitor should be in the “On Period”. Choosing 0 disables the “Off Timer”.

Advance notice (LED flashing green) will be given 15 minutes before the monitor automatically enters the “Off Timer Mode”.

■ To Delay Entering the “Off Timer Mode”

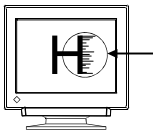
To delay entering the “Off Timer Mode”, press any keys on the front panel located to the left of the power switch during the “Advance notice Mode”. The monitor will continue to operate for an additional 90 minutes. There will be another advance notice for 15 minutes as described. Delayed entrance into the “Off Timer Mode” can be extended as many times as desired.

| | Function |
|---|---|
| <p>Signal Filter</p>   | <p>This monitor provides signal filter adjustments according to the characteristics of each graphics board for displaying the image properly. If the characteristics of the graphics board does not match those of the monitor, the characters and images displayed may have a slight shadow on their right side (refer to figure on the left). If these phenomenon is noticeable, use the “Signal Filter” function. Select from mode 1 or mode 2, whichever displays the image better.</p> |
| <p> Video Level</p> | <p>adjusts: Video Level</p> <p>Set the video level to adapt the output level of the computer or the graphics board.</p> |
| <p> Menu Position</p> | <p>adjusts: Menu Position</p> |

| | Function |
|--|--|
|  Reset | resets all the settings. <ul style="list-style-type: none"> - Default settings are as follows: <ul style="list-style-type: none"> · Contrast/Brightness: 100 % / 50 % · Moiré (Horizontal) 0 % (Vertical) 0 % · Color: 9300 K · PowerManager VESA DPMS On Off Timer Disable · Signal Filter Mode 1 · Video Level 0.7 V |

2-3. Shortcut Keys

Before entering the ScreenManager, brightness and contrast can be adjusted directly by moving the Control pad. To record the new setting and exit the ScreenManager, press the Enter key. (The brightness and contrast functions are also available in the ScreenManager “contrast/brightness” menu.)

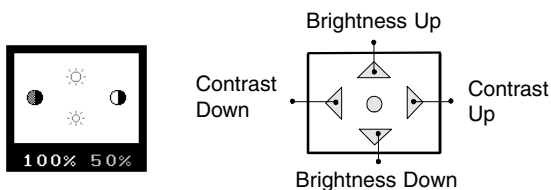

2-4. Adjustment Lock

The ScreenManager operation can be disabled by holding down the up arrow key on the control pad while switching on the monitor's power. This will disable (“lock”) the ScreenManager, protecting from accidental changes. To unlock the buttons: switch the power off, then hold down the up arrow key on the control pad once again and turn the power back on.

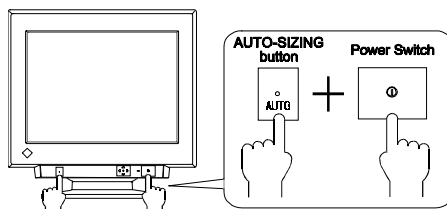

Note that brightness and contrast can be adjusted using the shortcut keys even while the Control pad is locked. After making such an adjustment, push the ENTER key to clear the brightness/contrast adjustment menu from the screen.



3 TROUBLESHOOTING

Troubleshooting

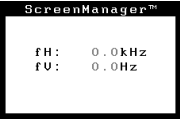
If a problem persists even after applying the suggested remedies, contact an EIZO dealer.

| Problems | Points to check with possible solutions |
|---|---|
| 1) Indicator status: OFF 2) Indicator status: GREEN 3) Indicator status: GREEN (flashing) 4) Indicator status: YELLOW 5) Indicator status: YELLOW (flashing) | <input type="checkbox"/> Check that the power cord is correctly connected. <input type="checkbox"/> Check brightness and contrast settings. Minimum settings will cause screen to be blank. <input type="checkbox"/> Try pressing a key on the keyboard, or clicking the mouse. (The monitor may be in a power saving mode.) <input type="checkbox"/> Try pressing a key on the keyboard, or clicking the mouse. (The monitor may be in a power saving mode.) <input type="checkbox"/> Try pressing any keys on the front panel, or switch the monitor off and then on. (The monitor may be in "Off Timer Mode".) If the problem persists, switch off the monitor power for a few minutes, then switch it back on and try again. |
| 6) Following message appears.  | <input type="checkbox"/> Check that the PC is switched ON. <input type="checkbox"/> Check that the signal cable is properly connected to the graphics board or PC. <input type="checkbox"/> Check that the graphics board is correctly inserted in the PC. |
| 7) Following message appears. (Example)  | <input type="checkbox"/> Use the graphics board's utility software to change the frequency setting. (Refer to the manual of the graphics board.) |
| NOTE <ul style="list-style-type: none"> Whenever an error signal message appears, the signal frequency will be displayed in red. Error messages shown above will remain on the screen for 30 seconds. An error message may not appear at all if the signal frequency is extremely high or extremely low. | |
| 8) The screen is partially dark. | <input type="checkbox"/> The CRT is not warmed up. Allow 30 minutes for the monitor to stabilize. <input type="checkbox"/> This problem may be caused by the earth's magnetism. Adjust the uniformity in the ScreenManager's "Screen" menu. See page 12. |

| Problems | Points to check with possible solutions |
|--|--|
| 9) The entire screen appears too dark or bright. | <input type="checkbox"/> Adjust the contrast and brightness using the ScreenManager. See page 11. <input type="checkbox"/> Output level from the computer may not conform the monitor. Please set the video level using the ScreenManager. See page 17. <input type="checkbox"/> Some signal timing can be the cause of this problem. To correct this, turn off the monitor, then hold down the AUTO-SIZING button and “down” arrow key while turning on the monitor again. This will change the signal timing and brighten the screen. If the above operation is repeated the screen becomes dark again. |
| 10) The screen is tilted/distorted. | <input type="checkbox"/> Adjust with the ScreenManager's tilt and distortion correcting function until tilt/distorting seems unnoticeable. See page 11. <input type="checkbox"/> Check to see if there are any nearby interfering electronic devices such as another monitor, an electric motor, or a speaker (other than an optional EIZO <i>i</i> -Sound speaker unit.) If so, move the device or move the monitor. <input type="checkbox"/> It is sometimes possible to correct distortion and tilting by reorienting the monitor. |
| 11) The image vibrates on the screen. | <input type="checkbox"/> Use of the “Moiré” adjustment may cause a slight vibration. To eliminate the vibration, set the adjustment level to lower percentage or 0%. See page 12. <input type="checkbox"/> Check that the signal cable is properly connected to the graphics board or PC. <input type="checkbox"/> Check that the graphics board is correctly mounted in the PC. <input type="checkbox"/> The monitor may be located close to a device that is generating a magnetic field. Such devices include speakers (other than the EIZO optional <i>i</i> -Sound speaker), electric motors, high-voltage cables, and other monitors. It may be solved by switching off or moving the interfering device, or by relocating the monitor. <input type="checkbox"/> If the volume level of the EIZO optional <i>i</i> -Sound speaker is too high, it may, in some cases, cause a slight vibration. To eliminate, turn down the volume of the speaker. |

NOTE

- An unstable signal from the graphics board may be the cause of the above problem when using the monitor with a high resolution or in a high refresh mode. (The video signal from the graphics board might be made irregular due to the use of a high speed dot clock.) Change the resolution or the refresh rate to another setting.

| Problems | Points to check with possible solutions |
|---|--|
| 12) The characters and images have a slight shadow on their right side. | <input type="checkbox"/> Change the mode of "Signal Filter" function in the ScreenManager "Others" menu. See page 17. <input type="checkbox"/> This may be solved by changing the refresh rate. |
| 13) Moiré patterns are distracting. | <input type="checkbox"/> Reduce the moiré using the ScreenManager's "Moiré" adjustment menu following the procedure below. <ol style="list-style-type: none"> 1) Set the desktop to an every-other-dot pattern so that moiré will be visible. 2) Go to the ScreenManager's "Moiré" menu and adjust so that moiré becomes almost unnoticeable. See page 12. 3) Change to a different desktop background to reduce moiré even further. <input type="checkbox"/> Change the horizontal and vertical dimensions of the display area. <input type="checkbox"/> Change the selected desktop or wallpaper pattern to any solid color pattern. For detailed information on how to change these patterns, refer to the documentation for the PC and operating system. |
| 14) The image is flickering. | <input type="checkbox"/> Flicker will occur with interlaced scanning, or non-interlaced scanning with a low refresh rate. All EIZO monitors are capable of reproducing high refresh rates for non-interlaced scanning. If a problem occurs when using a non-interlaced signal, try adjusting the graphics board to increase the refresh rate (if possible). Refer to the graphics board manual for information. |

Flicker

The term "flicker" refers to noticeable shimmering that occurs when the image on the screen is redrawn ("refreshed") too slowly. A refresh rate of 80 Hz means the image is redrawn 80 times per second. Most people will notice flicker at image refresh rates as high as 60 or 70 Hz, whereas refresh rates of 72 Hz or above usually is not noticeable. Flicker is known to be the cause of visual fatigue.

| | |
|---|---|
| 15) • The entire screen appears bluish or reddish. <ul style="list-style-type: none"> • Color purity is not uniform. • Misconvergence of colors. (red, green, blue) | <input type="checkbox"/> The CRT is not warmed up. Allow 30 minutes for the monitor to stabilize. |
|---|---|

Explanation of the Characteristics of CRTs

When the monitor is not fully warmed up, the screen may look slightly colored, e.g. reddish or bluish. This phenomenon is due to the unstableness of the electron gun during its warm-up period. Please wait for about 30 minutes until the monitor stabilizes in order to gain its proper color.

| Problems | Points to check with possible solutions |
|--|---|
| 16)• Control Pad “ENTER key” does not operate. • AUTO-SIZING button does not operate. | <input type="checkbox"/> The Adjustment Lock is probably on. To unlock: switch off the monitor power, then hold down the down arrow key of the control pad and switch the monitor back on. See page 18. |

4 CLEANING



WARNING

- **Keep liquids away from the monitor.**

Spillage into the cabinet may result in fire, electric shock, or equipment damage.

If an object or liquid falls/spills into the cabinet, unplug the monitor immediately. Have the unit checked by a qualified service engineer before using it again.

Using the monitor in this condition could cause serious injury or equipment damage.



E



CAUTION

- **To ensure safety, always unplug the monitor before cleaning it.**

Failure to do so may result in electric shock.

- **Periodically clean the area around the plug.**

Buildup of dust, water, or oil on the plug may result in fire.

- **Never use thinner, benzene, alcohol (ethanol, methanol, or isopropyl alcohol), abrasive cleaners, or other strong solvents, as these may cause damage to the cabinet or CRT.**



Periodic cleaning is recommended to keep the monitor looking new and to prolong its operational lifetime. Clean the cabinet and CRT areas as follows:

Cabinet

To remove stains, wipe the cabinet with a soft, lightly moistened cloth using a mild detergent. Do not spray wax or cleaner directly onto the cabinet.

CRT Surface

The CRT surface can be cleaned with a soft cloth, such as cotton or lens paper.

If necessary, stubborn stains can be removed by moistening part of a cloth with water to enhance its cleaning power.



5 SPECIFICATIONS

Electrical Specifications

| | |
|-----------------------------|---|
| CRT | 50 cm (19 inch) class, 90° deflection Invar Shadow Mask with Anti- Reflective SuperErgoCoat® |
| CRT AG Pitch | 0.26 mm |
| Scan Frequency(Horizontal): | 30 kHz-115 kHz (Automatic) |
| Scan Frequency (Vertical): | 50 Hz-160 Hz (Automatic) |
| Max. Active Display Area | 363 mm (H) × 272 mm (V) (14.3" (H) × 10.7" (V)) (Viewable image size: 453 mm (17.8")) * Display size can be set by the user through microprocessor control panel. * The actual size displayed can be dependent on the graphics board or PC utilized. |
| Power Supply | 100-120/220-240 VAC±10%, 50/60 Hz, 1.6/0.75 A |
| Power Consumption | |
| Normal/Max.: | 120 W/140 W (with EIZO optional speaker attached) |
| PowerManager Mode 1: | Less than 10 W |
| PowerManager Mode 2: | Less than 3 W |
| Input Connector | D-Sub mini 15-pin |
| Recommended Resolution | 1280 dots × 1024 lines |
| Input Signal(Sync): | <ul style="list-style-type: none">• H/V Separate, TTL, Positive/Negative• H/V Composite, TTL, Positive/Negative• Sync on Green 0.3 Vp-p, Negative |
| Input Signal(Video): | <ul style="list-style-type: none">• Analog 0.7 Vp-p/75 Ohm, Positive |
| Plug & Play | VESA DDC1/2B |

Mechanical Specifications

| | |
|------------|---|
| Dimensions | 452 mm (W) × 455 mm (H) × 478 mm (D) (17.8" (W) × 17.9" (H) × 18.8" (D)) |
| Weight | 22.8 kg (50.3 lbs.) |

Environmental Specifications

| | |
|-------------|---|
| Temperature | operating: 0°C to 35°C (32°F to 95°F) storage: -20°C to 60°C (-4°F to 140°F) |
| Humidity | 30% to 80% R.H. Non-condensing |

Certifications and Standards

| | |
|-------------------|---|
| 100-120 VAC range | UL/C-UL, FCC-B, DHHS, TÜV Rheinland/Ergonomics Approved, TCO'99, EPA Energy Star® Program |
| 220-240 VAC range | CE, CB, TÜV Rheinland/GS, TÜV Rheinland/Ergonomics Approved, TCO'99, EPA Energy Star® Program |

Preset Timing

2 factory presets shown below have been registered in the monitor's microprocessor.

| | Resolution | Frequencies | | Interlace | Sync Polarity | Video Signal Level |
|---------------|-------------|-------------|---------|-----------|--------------------------|--------------------|
| | | fH (kHz) | fV (Hz) | | | |
| VGA (text) | 720 × 400 | 31.47 | 70.09 | Non | H/Negative V/Positive | 0.7V(p-p)/75 Ohm |
| VESA | 1280 × 1024 | 91.15 | 85.02 | Non | H/Positive V/Positive | 0.7V(p-p)/75 Ohm |

Pin Assignment

D-Sub mini 15 pin connector

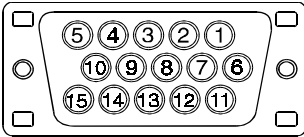

| Pin No. | Signal | Pin No. | Signal |
|---------|---|---------|--------------------------------|
| 1 | Red video | 9 | No pin |
| 2 | Green video/ Green video with composite sync | 10 | Ground (shorted) |
| | | 11 | |
| | | 12 | Data |
| 3 | Ground | 13 | H. Sync/ H/V composite sync |
| 4 | Ground | | |
| 5 | No pin | | |
| 6 | Red ground | 14 | V. Sync |
| 7 | Green ground | 15 | Clock |
| 8 | Blue ground | | |

Dimensions

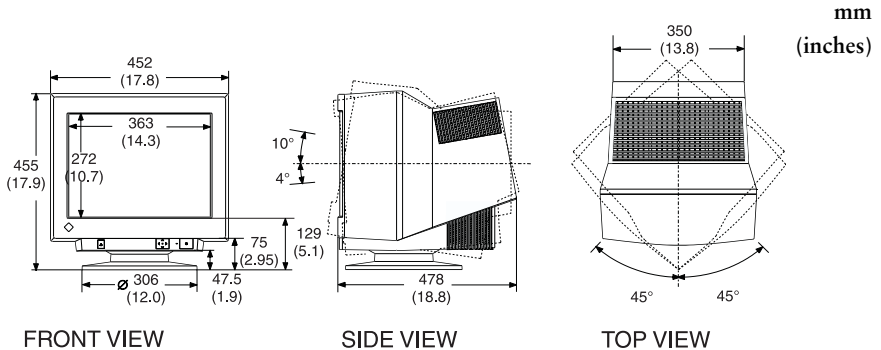





Congratulations!

You have just purchased a TCO'99 approved and labelled product! Your choice has provided you with a product developed for professional use. Your purchase has also contributed to reducing the burden on the environment and also to the further development of environmentally adapted electronics products.

Why do we have environmentally labelled computers?

In many countries, environmental labelling has become an established method for encouraging the adaptation of goods and services to the environment. The main problem, as far as computers and other electronics equipment are concerned, is that environmentally harmful substances are used both in the products and during their manufacture. Since it is not so far possible to satisfactorily recycle the majority of electronics equipment, most of these potentially damaging substances sooner or later enter nature.

There are also other characteristics of a computer, such as energy consumption levels, that are important from the viewpoints of both the work (internal) and natural (external) environments. Since all methods of electricity generation have a negative effect on the environment (e.g. acidic and climate-influencing emissions, radioactive waste), it is vital to save energy. Electronics equipment in offices is often left running continuously and thereby consumes a lot of energy.

What does labelling involve?

This product meets the requirements for the TCO'99 scheme which provides for international and environmental labelling of personal computers. The labelling scheme was developed as a joint effort by the TCO (The Swedish Confederation of Professional Employees), Svenska Naturskyddsforeningen (The Swedish Society for Nature Conservation) and Statens Energimyndighet (The Swedish National Energy Administration).

Approval requirements cover a wide range of issues: environment, ergonomics, usability, emission of electric and magnetic fields, energy consumption and electrical and fire safety.

The environmental demands impose restrictions on the presence and use of heavy metals, brominated and chlorinated flame retardants, CFCs (freons) and chlorinated solvents, among other things. The product must be prepared for recycling and the manufacturer is obliged to have an environmental policy which must be adhered to in each country where the company implements its operational policy.

The energy requirements include a demand that the computer and/or display, after a certain period of inactivity, shall reduce its power consumption to a lower level in one or more stages. The length of time to reactivate the computer shall be reasonable for the user.

Labelled products must meet strict environmental demands, for example, in respect of the reduction of electric and magnetic fields, physical and visual ergonomics and good usability.

Below you will find a brief summary of the environmental requirements met by this product. The complete environmental criteria document may be ordered from:

TCO Development

SE-114 94 Stockholm, Sweden

Fax: +46 8 782 92 07

Email (Internet): development@tco.se

Current information regarding TCO'99 approved and labelled products may also be obtained via the Internet, using the address: <http://www.tco-info.com/>

Environmental requirements

Flame retardants

Flame retardants are present in printed circuit boards, cables, wires, casings and housings. Their purpose is to prevent, or at least to delay the spread of fire. Up to 30% of the plastic in a computer casing can consist of flame retardant substances. Most flame retardants contain bromine or chloride, and those flame retardants are chemically related to another group of environmental toxins, PCBs. Both the flame retardants containing bromine or chloride and the PCBs are suspected of giving rise to severe health effects, including reproductive damage in fish-eating birds and mammals, due to the bio-accumulative* processes. Flame retardants have been found in human blood and researchers fear that disturbances in foetus development may occur.

The relevant TCO'99 demand requires that plastic components weighing more than 25 grams must not contain flame retardants with organically bound bromine or chlorine. Flame retardants are allowed in the printed circuit boards since no substitutes are available.

Cadmium**

Cadmium is present in rechargeable batteries and in the colour-generating layers of certain computer displays. Cadmium damages the nervous system and is toxic in high doses. The relevant TCO'99 requirement states that batteries, the colour-generating layers of display screens and the electrical or electronics components must not contain any cadmium.

Mercury**

Mercury is sometimes found in batteries, relays and switches. It damages the nervous system and is toxic in high doses. The relevant TCO'99 requirement states that batteries may not contain any mercury. It also demands that mercury is not present in any of the electrical or electronics components associated with the labelled unit.

CFCs (freons)

The relevant TCO'99 requirement states that neither CFCs nor HCFCs may be used during the manufacture and assembly of the product. CFCs (freons) are sometimes used for washing printed circuit boards. CFCs break down ozone and thereby damage the ozone layer in the stratosphere, causing increased reception on earth of ultraviolet light with e.g. increased risks of skin cancer (malignant melanoma) as a consequence.

Lead**

Lead can be found in picture tubes, display screens, solders and capacitors. Lead damages the nervous system and in higher doses, causes lead poisoning. The relevant TCO'99 requirement permits the inclusion of lead since no replacement has yet been developed.

For U.S.A, Canada, etc. (rated 100-120 Vac) Only

FCC Declaration of Conformity

We, the Responsible Party

EIZO NANA O TECHNOLOGIES INC.
5710 Warland Drive, Cypress, CA 90630
Phone: (562) 431-5011

declare that the product

Trade name: EIZO
Model: FlexScan F730

is in conformity with Part 15 of the FCC Rules. Operation of this product is subject to the following two conditions: (1) this device may not cause harmful interference, and (2) this device must accept any interference received, including interference that may cause undesired operation.

This equipment has been tested and found to comply with the limits for a Class B digital device, pursuant to Part 15 of the FCC Rules. These limits are designed to provide reasonable protection against harmful interference in a residential installation. This equipment generates, uses, and can radiate radio frequency energy and, if not installed and used in accordance with the instructions, may cause harmful interference to radio communications. However, there is no guarantee that interference will not occur in a particular installation. If this equipment does cause harmful interference to radio or television reception, which can be determined by turning the equipment off and on, the user is encouraged to try to correct the interference by one or more of the following measures.

- *Reorient or relocate the receiving antenna.
- *Increase the separation between the equipment and receiver.
- *Connect the equipment into an outlet on a circuit different from that to which the receiver is connected.
- *Consult the dealer or an experienced radio/TV technician for help.

Changes or modifications not expressly approved by the party responsible for compliance could void the user's authority to operate the equipment.

Note

Use the attached specified cable below or EIZO signal cable with this monitor so as to keep interference within the limits of a Class B digital device.

- AC Cord
- Shielded Signal Cable (D-SUB mini 15 pin - D-SUB mini 15 pin, the enclosed signal cable)

Canadian Notice

This Class B digital apparatus complies with Canadian ICES-003.

Cet appareil numérique de la classe B est conforme à la norme NMB-003 du Canada.

Hinweis zur Ergonomie :

Dieser Monitor erfüllt die Anforderungen an die Ergonomie nach EK1/59-98, EK1/60-98 mit dem Videosignal, 1280 Punkte x 1024 Zeilen, RGB analog, 0,7 Vp-p und mindestens 85,0 Hz Bildwiederholfrequenz, non interlaced.

Weiterhin wird aus ergonomischen Gründen empfohlen, die Grundfarbe Blau nicht auf dunklem Untergrund zu verwenden (schlechte Erkennbarkeit, Augenbelastung bei zu geringem Zeichenkontrast.)

PTB Hinweis

Eigensichere Kathodestranlröhre nach Anlage III Röntgenverordnung. Die in diesem Geraet entstehende Röntgenstrahlung ist durch die eigensichere Kathodenstrahlrohre ausreichend abgeschirmt.

Recycle Auskunft

Die Rücknahme dieses Produktes nach Nutzungsende übernimmt EIZO in Deutschland zusammen mit dem Partner von Roll MBB Recycling GmbH. Dort werden die Geräte in ihre Bestandteile zerlegt, die dann der Wiederverwertung zugeführt werden. Um einen Abholtermin zu vereinbaren und die aktuellen Kosten zu erfahren, benutzen Sie bitte folgende Rufnummer: 02153-73 35 00. Weitere Informationen finden Sie auch unter der Internet-Adresse: www.eizo.de.

Hinweis

Die Bildröhre dieses Monitors ist frei von Cadmium.