

# Service Manual

## 17" LCD MONITOR DELL E176FPc



THESE DOCUMENTS ARE FOR REPAIR SERVICE INFORMATION ONLY. EVERY REASONABLE EFFORT HAS BEEN MADE TO ENSURE THE ACCURACY OF THIS MANUAL; WE CANNOT GUARANTEE THE ACCURACY OF THIS INFORMATION AFTER THE DATE OF PUBLICATION AND DISCLAIMS RELIABILITY FOR CHANGES, ERRORS OR OMISSIONS.

**Revision List**

<b>Revision</b>	<b>Release Date</b>	<b>Revise history</b>	<b>TPV model</b>
A00	Aug.-26-2005	Initial Release	T780KCDHK8DLNP
			T780KGDHK8DZNP
			T780KGDHK8DENP
A01	Mar.-31-2006	Add” <b>Definition Of Pixel Defects</b> ”	
A02	April-25-2006	Add” <b>Max Brightness measurement</b> ” on Page43	
A03	Mar.-30-2007	Add Mechanical Instruction in item 6	

<b>Table of contents</b>	
<b>Table of contents</b>	02
<b>1. Monitor Specifications</b>	04
<b>2. LCD Monitor Description</b>	05
<b>3. Operation instructions</b>	06
3.1 General Instructions	06
3.2 Control buttons	06
3.3 On Screen Menu/Display (OSD)	07
3.4 Adjusting the Picture	08
<b>4. Input/Output Specification</b>	13
4.1 Input Signal Connector	13
4.2 Factory Preset Display Modes	13
4.3 Power Supply Requirements	14
4.4 Panel Specification	15
<b>5. Block Diagram</b>	18
5.1 Monitor Exploded View	18
5.2 Software Flow Chart	19
5.3 Electrical Block Diagram	21
<b>6. Mechanical Instruction</b>	23
<b>7. Schematic Diagram</b>	28
6.1 Main Board	28
6.2 Power Board	33
<b>8. Layout</b>	35
7.1 Main Board	35
7.2 Power Board	37
7.3 Key Board	40
<b>9. Maintainability</b>	41
8.1 Equipments and Tools Requirement	41
8.2 Trouble Shooting	42
<b>10. White Balance Adjustment</b>	48
<b>11. EDID Content</b>	49
<b>12. ISP User Manual</b>	50
12.1 Connect ISP Writer preparation action	50
12.2 To Use ISP WRITER	51
12.3 Executing ISP	55
<b>13. Check List</b>	56
<b>14. BOM List</b>	59
<b>15. Definition Of Pixel Defects</b>	70

## 1. Monitor Specifications

LCD Panel	Screen type	Active matrix - TFT LCD
	Panel Type	LM170E01-TLB3/TLB4 (LPL) CLAA170EA07 (CPT)
	Size	430mm(17.0")
	Pixel pitch	0.264mm(H) x 0.264mm(V)
	Viewable angle (CR>=10)	LM170E01-TLB3/TLB4: 70°/70° (H) 75°/65° (V) (typ.) CLAA170EA07: 70°/70° (H) 67°/63° (V) (typ.)
	Response time	LM170E01-TLB3/TLB4: 8ms(type) CLAA170EA07: 12ms(type)
Input	Video	R, G, B Analog Interface
	Separate Sync	H/V TTL
	H-Frequency	30kHz – 80kHz
	V-Frequency	55 - 75Hz
Display Colors		16.2M Colors
Dot Clock		135MHz(Max)
Max. Resolution		1280 x 1024
Plug & Play		VESA DDC
EPA ENERGY STAR®	ON Mode	<45W
	OFF Mode	<2W
Input Connector		D-Sub 15pin
Input Video Signal		Analog:0. 7Vp-p(standard) 75 OHM, Positive
Maximum Screen Size		Horizontal : 337.92mm Vertical: 270.336mm
Power Source		100 V ~ 240 V± 10 %VAC, 50 ± 3Hz, 60 ± 3Hz
Environmental Considerations		Operating Temp: 5° to 35°C Operating Humidity: 10% to 80% Storage Temp.: -20° to 60°C
Weight	Monitor (Stand and Head): 5.2kg (11.5 lb)	
	Monitor Flat panel only (VESA Mode): 4.0 kg (8.8 lb)	
	Weight with packaging: 6.4 kg (14.1 lb)	

## 2. LCD Monitor Description

The LCD MONITOR will contain a main board, PWPC board, keypad board, which house the flat panel control logic, brightness control logic and DDC.

The power board will provide AC to DC Inverter voltage to drive the backlight of panel and the main board chips each voltage.

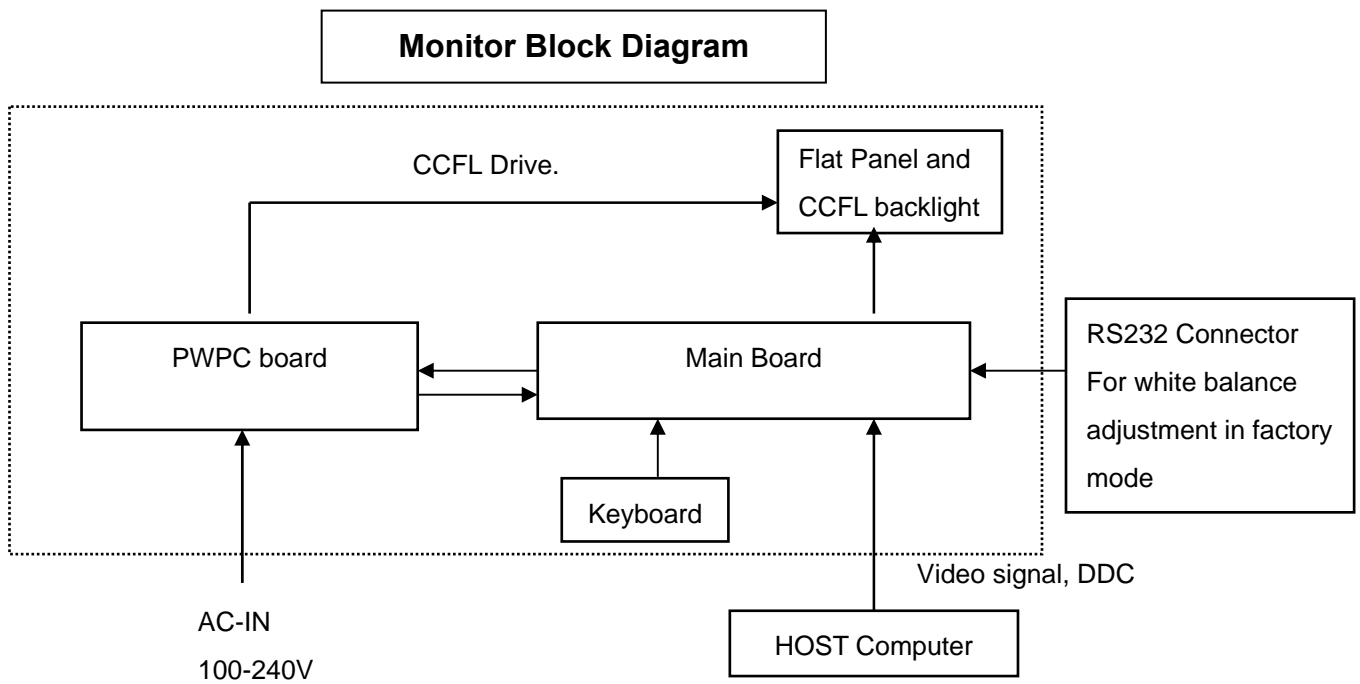

### 3. Operation instructions

#### 3.1 General Instructions







Press the power button to turn the monitor on or off. The other control buttons are located at front panel of the monitor. By changing these settings, the picture can be adjusted to your personal preferences.

- The power cord should be connected.
- Connect the video cable from the monitor to the video card.
- Press the power button to turn on the monitor, the power indicator will light up.

#### 3.2 Control Buttons











- 1 Menu selection button
- 2 Brightness Contrast / Down (-) button
- 3 Auto-Adjust / Up (+) button
- 4 Power button On/Off button with indicator

A	 <b>MENU</b>	<p>The 'MENU' button is used to open the on-screen display (OSD), select function icons, exit from menus and sub-menus, and to exit the OSD. See <a href="#">Accessing the Menu System</a>.</p>
B	 <b>Brightness/Contrast Hot Key</b>	<p>Use this button for direct access to the 'Brightness' and 'Contrast' control menu.</p>
B C	 <b>- and + buttons</b>	<p>Use these buttons to adjust (decrease/increase ranges) items in the OSD.</p>
C	 <b>Auto Adjust</b>	<p>Use this button to activate automatic setup and adjustment. The following dialog will appear on screen as the monitor self-adjusts to the current input:</p> <div style="background-color: black; color: white; text-align: center; padding: 5px; margin: 10px 0;">Auto Adjust In Progress</div> <p>Auto Adjustment  button allows the monitor to self-adjust to the incoming video signal. After using 'Auto Adjustment', you can further tune your monitor by using the 'Pixel Clock' and 'Phase' controls in the OSD.</p>
D	 <b>Power Button &amp; Indicator</b>	<p>The green LED indicates the monitor is on and fully functional. An amber LED indicates DPMS power save mode.</p> <p>The Power button turns the monitor on and off.</p>

### 3.3 On Screen Menu/Display (OSD)

#### Direct-Access Functions

Function	Adjustment Method
<p><b>Auto adjustment</b></p>	<p>Use this button to activate automatic setup and adjustment. The following dialog will appear on screen as the monitor self-adjusts to the current input:</p> <div data-bbox="853 488 1279 551" style="background-color: black; color: white; text-align: center; padding: 5px;"> <p>Auto Adjust In Progress</p> </div> <p>Auto Adjustment  button allows the monitor to self-adjust to the incoming video signal. After using 'Auto Adjustment', you can further tune your monitor by using the 'Pixel Clock' and 'Phase' controls in the OSD.</p> <p> <b>NOTE:</b> Auto Adjust will not occur if you press the button while there are no active video input signals, or attached cables</p>
<p><b>Brightness / Contrast</b></p> <div data-bbox="111 1030 826 1444" style="background-color: black; color: white; padding: 10px;"> <p style="text-align: center; font-weight: bold;">Brightness/Contrast</p> <div style="display: flex; justify-content: space-between; align-items: center;"> <div style="background-color: #ccc; padding: 5px;">Exit</div>  </div> <div style="display: flex; justify-content: space-between; align-items: center; margin-top: 10px;"> <div style="text-align: center;"> <p><b>Brightness</b></p>  </div> <div style="text-align: center;">  <p>75</p> </div> </div> <div style="display: flex; justify-content: space-between; align-items: center; margin-top: 10px;"> <div style="text-align: center;"> <p><b>Contrast</b></p>  </div> <div style="text-align: center;">  <p>75</p> </div> </div> </div>	<p>With the menu off, push  button to display the 'Brightness' and 'Contrast' adjustment menu.</p> <p>The 'Brightness' function adjusts the luminance of the flat panel.</p> <p>Adjust 'Brightness' first, then adjust 'Contrast' only if further adjustment is necessary.</p> <p>"+" increase 'brightness'          "-" decrease 'brightness'</p> <p>The 'Contrast' function adjusts the degree of difference between darkness and lightness on the display screen.</p> <p>"+" increase the 'contrast'          "-" decrease the 'contrast'</p>

### 3.4 Adjusting the Picture



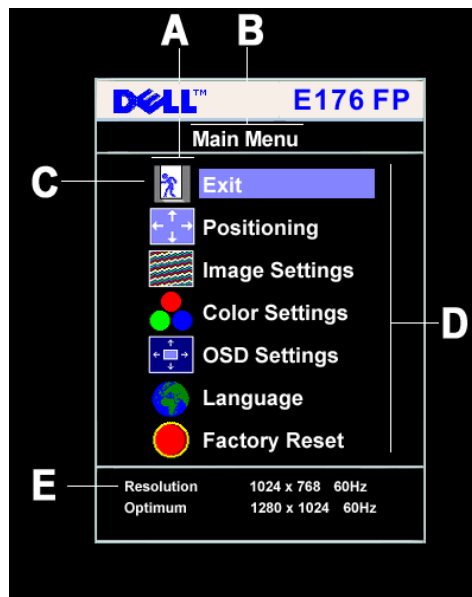







1. With the menu off, push the 'MENU' button to open the OSD system and display the main features menu.











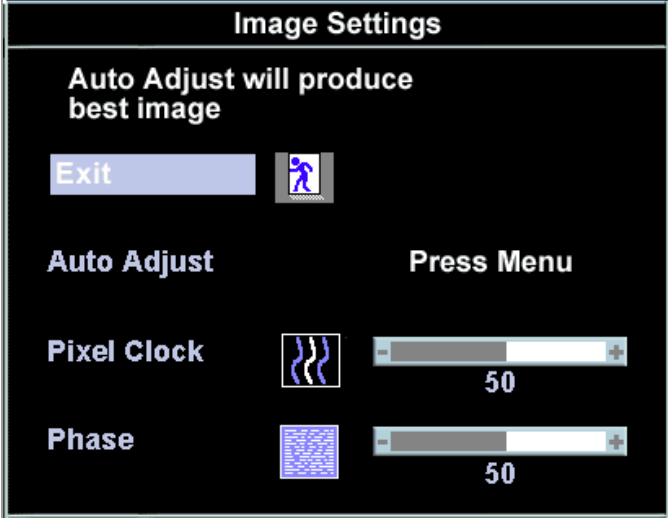



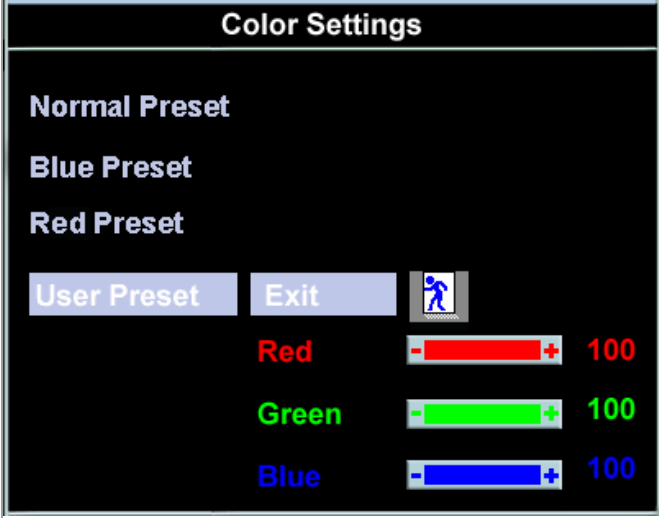

- |          |                |          |            |          |           |
|----------|----------------|----------|------------|----------|-----------|
| <b>A</b> | Function icons | <b>B</b> | Main Menu  | <b>C</b> | Menu icon |
| <b>D</b> | Sub-Menu name  | <b>E</b> | Resolution |          |           |





2. Push the - and + buttons to move between the function icons. As you move from one icon to another, the function name is highlighted to reflect the function or group of functions (sub-menus) represented by that icon. See the table below for a complete list of all the functions available for the monitor.
3. Push the 'MENU' button once to activate the highlighted function; Push -/+ to select the desired parameter, push menu to enter the slide bar. Then use the - and + buttons, according to the indicators on the menu, to make your changes.
4. Push the 'Menu' button once to return to the main menu to select another function or push the 'Menu' button two or three times to exit from the OSD.



Icon	Menu Name and Sub-menus	Description
	EXIT	This is used to exit out of the 'Main menu'.
	Positioning: Horizontal Vertical	<p>'Positioning' moves the viewing area around on the monitor screen.</p> <p>When making changes to either the 'Horizontal' or 'Vertical' settings, no changes will occur to the size of the viewing area; the image will simply be shifted in response to your selection/change.</p> <p>Minimum is '0' (-). Maximum is '100' (+).</p> <div data-bbox="464 624 1115 987" style="border: 1px solid black; background-color: #333; color: #fff; padding: 10px; margin: 10px 0;"> <p style="text-align: center; font-weight: bold;">Positioning</p> <div style="display: flex; justify-content: space-between; align-items: center;"> <span style="background-color: #ccc; padding: 2px 5px;">Exit</span>  </div> <div style="display: flex; justify-content: space-between; align-items: center; margin-top: 10px;"> <div style="text-align: center;"> <p><b>Horizontal</b></p>  </div> <div style="text-align: center;">  <p>50</p> </div> </div> <div style="display: flex; justify-content: space-between; align-items: center; margin-top: 10px;"> <div style="text-align: center;"> <p><b>Vertical</b></p>  </div> <div style="text-align: center;">  <p>50</p> </div> </div> </div>
	Image settings:  Auto Adjust        Pixel Clock	<p>Even though your computer system can recognize your new flat panel monitor on startup, the 'Auto Adjustment' function will optimize the display settings for use with your particular setup.</p> <p> <i>NOTE: In most cases, 'Auto Adjust' will produce the best image for your configuration; this function can be directly access via Auto Adjustment</i></p> <p> <i>hotkey.</i></p> <p>The 'Phase' and 'Pixel Clock' adjustments allow you to more closely adjust your monitor to your preference. These settings are accessed through the main OSD menu, by selecting 'Image Settings'.</p> <p>Use the - and + buttons to adjust away interference. Minimum: 0 ~ Maximum: 100</p>

	<p>Phase</p>	<p>If satisfactory results are not obtained using the 'Phase' adjustment, use the 'Pixel Clock' adjustment and then use 'Phase' again.</p>  <p><b>Image Settings</b></p> <p>Auto Adjust will produce best image</p> <p>Exit </p> <p>Auto Adjust <span style="margin-left: 150px;">Press Menu</span></p> <p>Pixel Clock  <span style="margin-left: 20px;">50</span></p> <p>Phase  <span style="margin-left: 20px;">50</span></p> <p> <b>NOTE:</b> This function may change the width of the display image. Use the 'Horizontal' function of the 'Position' menu to center the display image on the screen.</p>
	<p>Color Settings:</p>	<p>'Color Settings' adjusts the color temperature and saturation.</p>  <p><b>Color Settings</b></p> <p>Normal Preset</p> <p>Blue Preset</p> <p>Red Preset</p> <p>User Preset <span style="margin-left: 20px;">Exit</span> </p> <p>Red <span style="margin-left: 20px;">100</span></p> <p>Green <span style="margin-left: 20px;">100</span></p> <p>Blue <span style="margin-left: 20px;">100</span></p> <p>Normal Preset</p> <p>'Normal Preset' is selected to obtain the default (factory) color settings.</p> <p>Blue Preset</p> <p>'Blue Preset' is selected to obtain a bluish tint. This color setting is typically used for text based applications (Spreadsheets, Programming, Text Editors etc.).</p> <p>Red Preset</p> <p>'Red Preset' is selected to obtain a redder tint. This color setting is typically used for color intensive applications (Photograph Image Editing, Multimedia, Movies etc.).</p>

	<p>User Preset</p>	<p>'User Preset': Use the plus and minus buttons to increase or decrease each of the three colors (R, G, B) independently, in single digit increments, from '0' to '100'.</p> <p> <i>NOTE: 'Color temperature' is a measure of the 'warmth' of the image colors (red/green/blue). The two available presets ('Blue' and 'Red') favor blue and red accordingly. Select each one to see how each range suits your eye; or utilize the 'User Preset' option to customize the color settings to your exact choice.</i></p>
<p></p> <p></p> <p></p> <p></p>	<p>OSD Settings:</p> <p>Horizontal Position</p> <p>Vertical Position</p> <p>OSD Hold Time:</p> <p>OSD Lock</p>	<p>Each time the OSD opens, it displays in the same location on the screen. 'OSD Settings' (horizontal/vertical) provides control over this location.</p> <p>- and + buttons move OSD to the left and right.</p> <p>- and + buttons move OSD down and up.</p> <p>The OSD stays active for as long as it is in use.</p> <p>'OSD Hold Time': Sets the length of time the OSD will remain active after the last time you pressed a button.</p> <p>Use the - and + buttons to adjust the slider in 5 second increments, from 5 to 60 seconds.</p> <p> <i>NOTE: Default 'OSD hold time' is 20 seconds.</i></p> <p>'OSD Lock': Controls user access to adjustments. When 'Yes' (+) is selected, no user adjustments are allowed. All buttons are locked except the menu button.</p> <p>All buttons can be locked or unlocked press the 'Menu' button for over 15 seconds. to unlock the OSD 'Menu'.</p>
		<div data-bbox="469 1290 1134 1776" data-label="Image"> </div> <p> <i>NOTE: When the OSD is locked, pressing the 'Menu' button will take the user directly to the 'OSD settings' menu, with 'OSD Lock' preselected on entry. Select 'No'(-) to unlock and allow user access to all applicable settings.</i></p>

	<p>Language:</p>	<p>Language sets the OSD to display in one of five languages (English, Español, Français, Deutsch, Japanese).</p> <div data-bbox="466 244 852 627" style="border: 1px solid black; background-color: black; color: white; padding: 5px;"> <p style="text-align: center;">Language</p> <div style="display: flex; justify-content: space-between; align-items: center;">  Exit         </div> <div style="display: flex; justify-content: space-between; align-items: center;">  English         </div> <div style="display: flex; justify-content: space-between; align-items: center;">  Español         </div> <div style="display: flex; justify-content: space-between; align-items: center;">  Français         </div> <div style="display: flex; justify-content: space-between; align-items: center;">  Deutsch         </div> <div style="display: flex; justify-content: space-between; align-items: center;">  日本語         </div> </div> <p> <i>NOTE: The language chosen affects only the language of the OSD. It has no effect on any software running on the computer.</i></p>
	<p>Factory Reset:</p>	<p>'Factory Reset' returns the settings to the factory preset values for the selected group of functions. 'Exit' is used to exit out of 'Factory Reset' menu.</p> <p>For 'All settings', all user adjustable settings are reset at one time except 'Language settings'.</p>

OSD Warning Messages

A warning message may appear on the screen indicating that the monitor is out of sync.

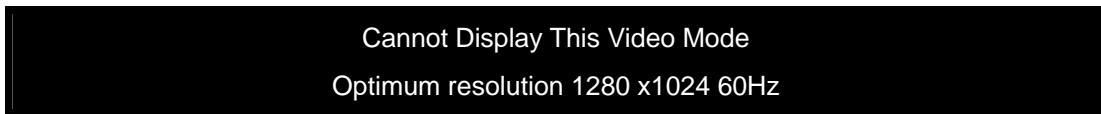

This means that the monitor cannot synchronize with the signal that it is receiving from the computer. Either the signal is too high or too low for the monitor to use. See Specifications for the Horizontal and Vertical frequency ranges addressable by this monitor. Recommended mode is 1280 X 1024 @ 60Hz.

 *NOTE: The floating 'Dell - self-test Feature Check' dialog will appear on-screen if the monitor cannot sense a video signal.*

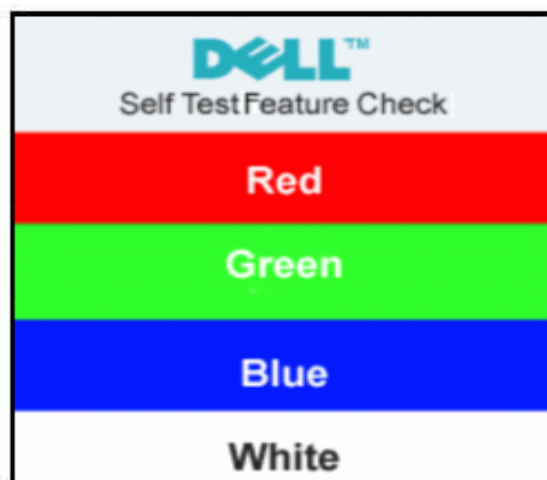

Occasionally, no warning message appears, but the screen is blank. This could also indicate that the monitor is not synchronizing with the computer. See Troubleshooting for more information.

## 4. Input/Output Specification

### 4.1 Input Signal Connector

PIN NO.	DESCRIPTION	PIN NO.	DESCRIPTION
1.	Red Video	9.	+5V
2.	Green Video	10.	Logic Ground
3.	Blue Video	11.	RXD
4.	TXD	12.	DDC-Serial Data
5.	Detector Pin	13.	H-Sync
6.	R-Ground	14.	V-Sync
7.	G-Ground	15.	DDC-Serial Clock
8.	B-Ground		

VGA Connector layout

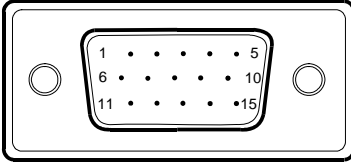

### 4.2 Factory Preset Display Modes

VESA MODES							
Mode	Resolution	Total	Horizontal		Vertical		Nominal Pixel Clock (MHz)
			Nominal Frequency +/- 0.5kHz	Sync Polarity	Nominal Freq. +/- 1Hz	Sync Polarity	
VGA	640x480@60Hz	800 x 525	31.469	N	59.940	N	25.175
	640x480@75Hz	840 x 500	37.500	N	75.00	N	31.500
	800x600@60Hz	1056 x 628	37.879	P	60.317	P	40.000
	800x600@75Hz	1056x625	46.875	P	75.000	P	49.500
XGA	1024x768@60Hz	1344x806	48.363	N	60.004	N	65.000
	1024x768@75Hz	1312x800	60.023	P	75.029	P	78.750
SXGA	1152x864@75Hz	1600x900	67.500	P	75.000	P	108.00
	1280x1024@60Hz	1688x1066	64.000	P	60.000	P	108.00
	1280x1024@75Hz	1688x1066	79.976	P	75.025	P	135.00
IBM MODES							
Mode	Resolution	Total	Nominal Frequency +/- 0.5kHz	Sync Polarity	Nominal Freq. +/- 1 Hz	Sync Polarity	Nominal Pixel Clock (MHz)
DOS	720x400@70Hz	900 x 449	31.469	N	70.087	P	28.322

### 4.3 Power Supply Requirements

A/C Line voltage range	100 V ~ 240 V $\pm$ 10 %
A/C Line frequency range	50 $\pm$ 3Hz, 60 $\pm$ 3Hz
Input Voltage transients	280 volts AC for 10 sec @40°C
Current	0.6A max. at 100V, 0.35A max. at 240 V
Peak surge current	< 60A peak at 240 VAC and cold starting < 30A peak at 120VAC and cold starting
Leakage current	< 3.5mA
Power line surge	No advance effects (no loss of information or defect) with a maximum of 1 half-wave missing per second

## 4.4 Panel Specification

### Display Characteristics (For LM170E01-TLB3 panel)

Active screen size	17.0 inch (43.27cm) diagonal
Outline Dimension	358.5(H) x 296.5(V) x 17.0(D) mm(Typ.)
Pixel Pitch	0.264 mm x 0.264 mm
Pixel Format	1280 horiz. by 1024 vert. Pixels. RGB stripe arrangement
Display Colors	16.2M colors
Luminance, white	300 cd/m <sup>2</sup> (Typ. Center 1 point)
Power Consumption	19.4 Watts(Typ.)
Weight	2150g (Typ.)
Display operating mode	Transmissive mode, normally white
Surface treatments	Hard coating (3H), Anti-glare treatment of the front polarizer

### Display Characteristics (For LM170E01-TLB4 panel)

Active screen size	17.0 inch (43.27cm) diagonal
Outline Dimension	358.5(H) x 296.5(V) x 17.0(D) mm(Typ.)
Pixel Pitch	0.264 mm x 0.264 mm
Pixel Format	1280 horiz. by 1024 vert. Pixels. RGB stripe arrangement
Display Colors	16.2M colors
Luminance, white	300 cd/m <sup>2</sup> (Typ. Center 1 point)
Power Consumption	19.6 Watts(Typ.)
Weight	2150g (Typ.)
Display operating mode	Transmissive mode, normally white
Surface treatments	Hard coating (3H), Anti-glare treatment of the front polarizer

### Display Characteristics (For CLAA170EA07 panel)

ITEM	SPECIFICATION
Display Area(mm)	337.920(H)x270.336(V) (17.0-inch diagonal)
Number of Pixels	1280(H)x1024(V)
Pixel Pitch(mm)	0.264(H)x0.264(V)
Color Pixel Arrangement	RGB vertical stripe
Display Mode	normally white, TN
Number of Colors	16.2M(6 Bit+FRC)
Brightness(cd/m <sup>2</sup> )	300 cd/m <sup>2</sup> (Typ.)(Center point, Lamp current=7.0 mA)
Viewing Angle	140/130(Typ.)
Surface Treatment	Anti-glare
Electrical Interface	LVDS , 2Ch
Total Module Power(W)	20.0 (Typ.)
Optimum Viewing Angle	6 o'clock
Module Size(mm)	358.5(W)x296.5(H)x17.5(D)
Module Weight(g)	2000(typ)
Backlight Unit	CCFL, 4 tables, edge-light(top*2/bottom*2)

## 4.4.2 Optical Characteristics (For LM170E01- TLB3/TLB4 panel)

Parameter	Symbol	Values			Units	Notes
		Min.	Typ.	Max.		
Contrast ratio	CR	500	700	-		1
Surface luminance, white	$L_{WH}$	250	300	-	cd/m <sup>2</sup>	2
Luminance uniformity	$\Delta L_{\phi}$	75	-	-	%	3
Response time	$T_r$		8	18	ms	4
Rise time	$T_{rR}$	-	2	6		
Decay time	$T_{rD}$	-	6	12		
CIE color coordinates						
Red	XR	0.605	0.635	0.665		
	YR	0.312	0.342	0.372		
Green	XG	0.262	0.292	0.322		
	YG	0.581	0.611	0.641		
Blue	XB	0.117	0.147	0.177		
	YB	0.040	0.070	0.100		
White	XW	0.283	0.313	0.343		
	YW	0.299	0.329	0.359		
Viewing angle (by CR $\geq$ 10)						
X axis, right ( $\phi=0^\circ$ )	$\theta_r$	60	70	-	degree	5
X axis, left ( $\phi=180^\circ$ )	$\theta_l$	60	70	-		
Y axis, up ( $\phi=90^\circ$ )	$\theta_u$	60	75	-		
Y axis, down ( $\phi=270^\circ$ )	$\theta_d$	50	65	-		
Viewing angle (by CR $\geq$ 5)						
X axis, right ( $\phi=0^\circ$ )	$\theta_r$	70	80	-	degree	
X axis, left ( $\phi=180^\circ$ )	$\theta_l$	70	80	-		
Y axis, up ( $\phi=90^\circ$ )	$\theta_u$	70	85	-		
Y axis, down ( $\phi=270^\circ$ )	$\theta_d$	60	75	-		
Relative brightness						6
Luminance uniformity (TCO99)		-	-	1.7		Figure 10



## Optical Characteristics (For CLAA170EA07 panel)

Ta=25 °C , VCC=5.0V

ITEM		SYMBOL	CONDITION	MIN.	TYP.	MAX.	UNIT
Contrast Ratio		CR	$\theta = \psi = 0^\circ$	450	500	--	--
Luminance	Center	L	$\theta = \psi = 0^\circ$	250	300	--	cd/m <sup>2</sup>
	Uniformity	$\Delta L$	$\theta = \psi = 0^\circ$	75%	--	--	
Response Time		Tr	$\theta = \psi = 0^\circ$	--	5	10	ms
		Tf	$\theta = \psi = 0^\circ$	--	7	14	ms
Viewing Angle	Horizontal	$\psi$	CR $\geq 5$	80/80	85/85	--	°
	Vertical	$\theta$		80/80	85/85	--	°
	Horizontal	$\psi$	CR $\geq 10$	60/60	70/70	--	°
	Vertical	$\theta$		60/55	67/63	--	°
Color Coordinates	White	Wx Wy	$\theta = \psi = 0^\circ$	0.283 0.299	0.313 0.329	0.343 0.359	--
	Red	Rx Ry		0.614 0.308	0.644 0.338	0.674 0.368	
	Green	Gx Gy		0.237 0.592	0.267 0.622	0.297 0.652	
	Blue	Bx By		0.110 0.054	0.140 0.084	0.170 0.114	
Image sticking		Tis	2 hour			2	sec
Crosstalk		CT				1%	
Flicker		f		--	--	-20	db
Gamut		CS		69%	72%		
Gamma		$\gamma$	GL(32-223)	2.0	2.3	2.6	

## 5. Block Diagram

### 5.1 Monitor Exploded View

Index	Parts name	Parts number	Qty	Index	Parts name	Parts number	Qty
1	Bezel	34G1611	1	12	Holder bracket R	15G8185	1
2	Button-Function	33G4884	1	13	Holder bracket L	15G8186	1
3	Rear cover	34G1612	1	14	Shield-Inventor	85G703	1
4	Cover-Vesa	34G1614	1	15	Shield-wire	85G702	1
5	Stand-F	34G1615	1	16	Stand holder	20G027-2	1
6	Stand-B	34G1616	1	17	Stand-diecasting	20G030	1
7	Base	34G1617	1	18	Spring-holder	19G588	2
8	Button-release	33G4885	1	19	Spring-button	19G589	1
9	Mainframe	15G8187	1	20	Hinge	37G535-2	1
10	Base plate	15G8188	1	21	Kensington bkt	15G8146	1
11	Vesa_plate	15G8190	1	22	Rubber foot	12L6097	8

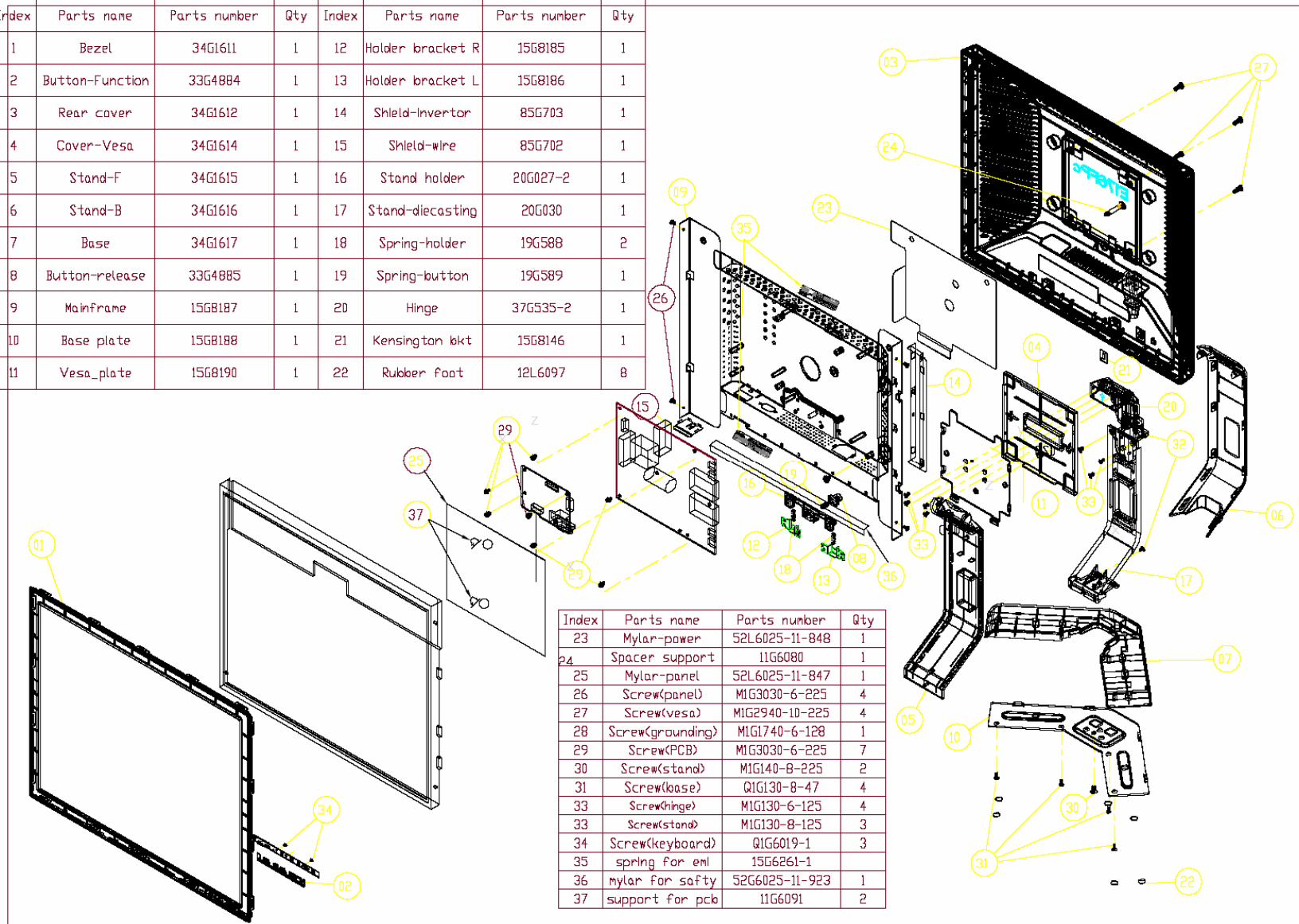

Index	Parts name	Parts number	Qty
23	Mylar-power	52L6025-11-848	1
24	Spacer support	11G6080	1
25	Mylar-panel	52L6025-11-847	1
26	Screw(panel)	MIG3030-6-225	4
27	Screw(vesa)	MIG2940-10-225	4
28	Screw(grounding)	MIG1740-6-128	1
29	Screw(PCB)	MIG3030-6-225	7
30	Screw(stand)	MIG140-8-225	2
31	Screw(base)	QIG130-8-47	4
33	Screw(hinge)	MIG130-6-125	4
33	Screw(stand)	MIG130-8-125	3
34	Screw(keyboard)	QIG6019-1	3
35	spring for emi	15G6261-1	
36	mylar for safty	52G6025-11-923	1
37	support for pcb	11G6091	2

## 5.2 Software Flow Chart

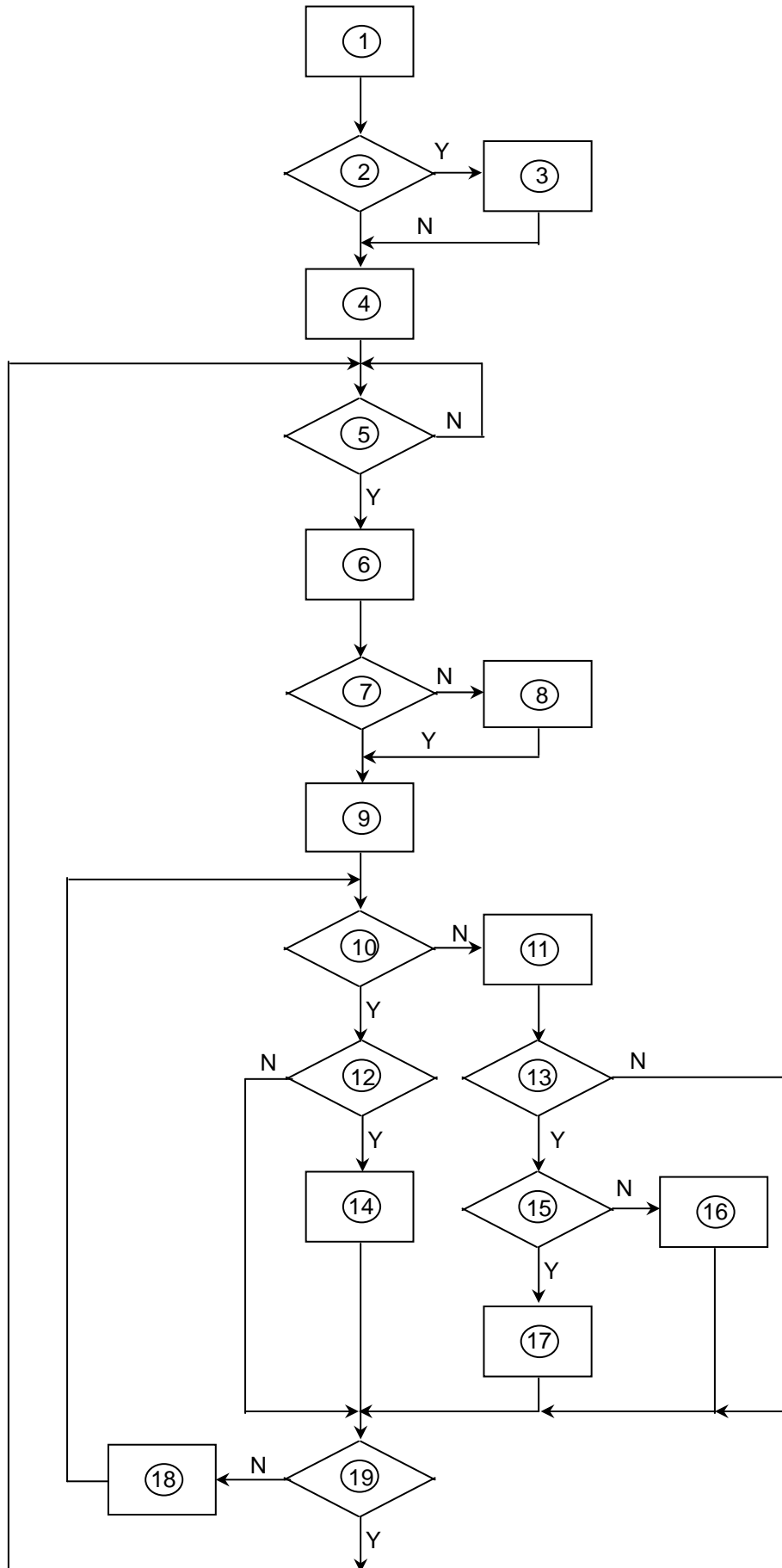

- 1) MCU Initializes.
- 2) Is the EEPROM blank?
- 3) Program the EEPROM by default values.
- 4) Get the PWM value of brightness from EEPROM.
- 5) Is the power key pressed?
- 6) Clear all global flags.
- 7) Are the AUTO and SELECT keys pressed?
- 8) Enter factory mode.
- 9) Save the power key status into EEPROM.  
Turn on the LED and set it to green color. Scalar initializes.
- 10) In standby mode?
- 11) Update the lifetime of back light.
- 12) Check the analog port, are there any signals coming?
- 13) Does the scalar send out an interrupt request?
- 14) Wake up the scalar.
- 15) Are there any signals coming from analog port?
- 16) Display "No connection Check Signal Cable" message. And go into standby mode after the message disappears.
- 17) Program the scalar to be able to show the coming mode.
- 18) Process the OSD display.
- 19) Read the keyboard. Is the power key pressed?

### 5.3 Electrical Block Diagram

#### 5.3.1 Main Board

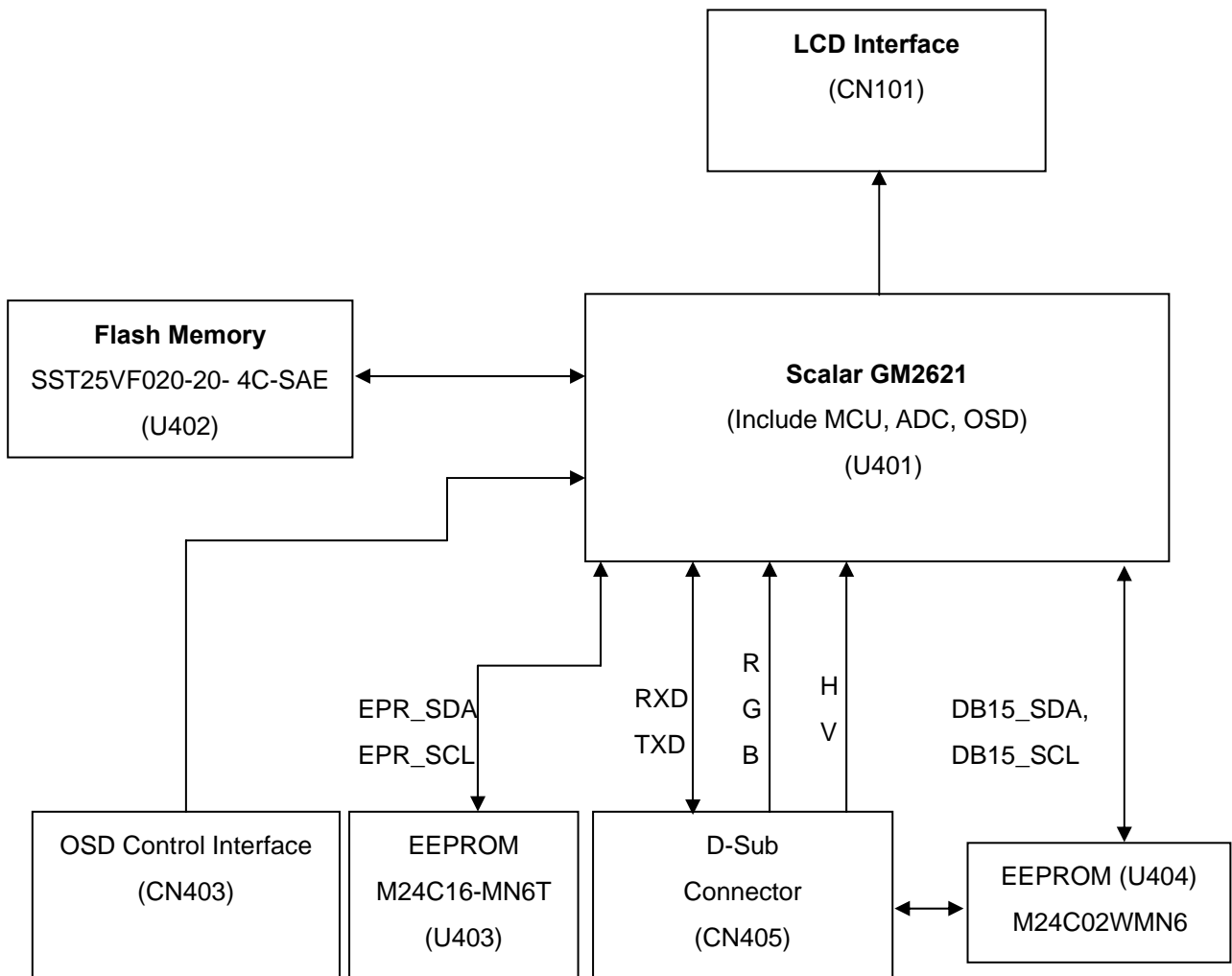

### 5.3.2 Inverter/Power Board

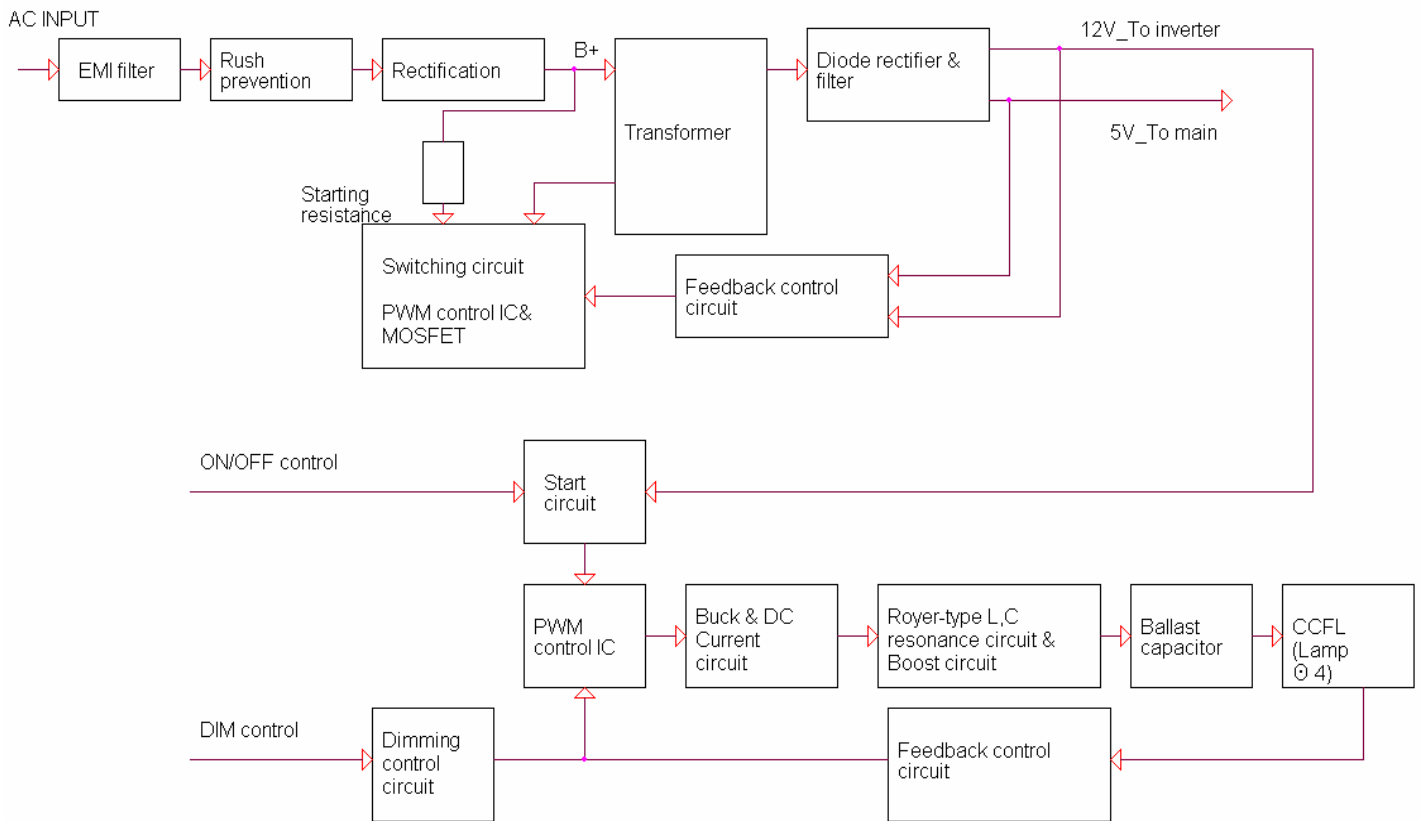



## 6. Disassembly Flow Chart

**Tools: 2 Power screwdrivers ( $\phi=5\text{mm}$ ,  $L=60\text{mm}$ ); 1 small cross screwdriver; turnbuckle driver;**

**Setting: Power screwdriver torque A=11 kgF. Cm; torque B=6 kgF. Cm**

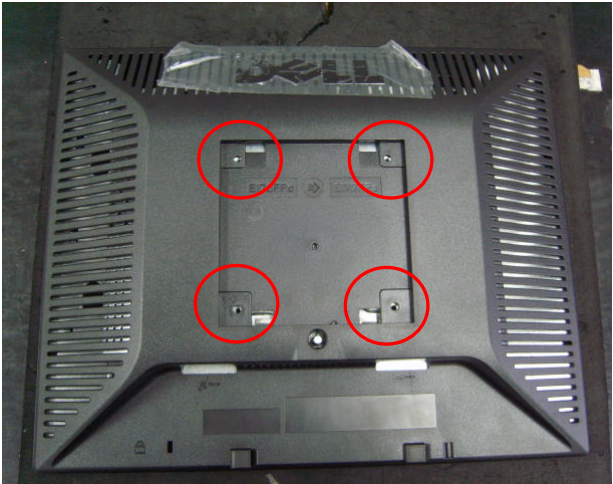
Note: Firstly, put the monitor on a soft, flat and clean surface, wear gloves.

Fig	Remark
	<p><b>Remove stand:</b> Press the Stand release button and lift up the Stand and away from the monitor.</p>
	<p><b>Remove bezel:</b> 1. Remove the 4 screws by torque A</p>
	<p>2. Pry the monitor up then find out the hooks' position, use the tool (like the picture or other card) to insert into the gap of bezel and rear cover.</p>



3. Take off the bezel

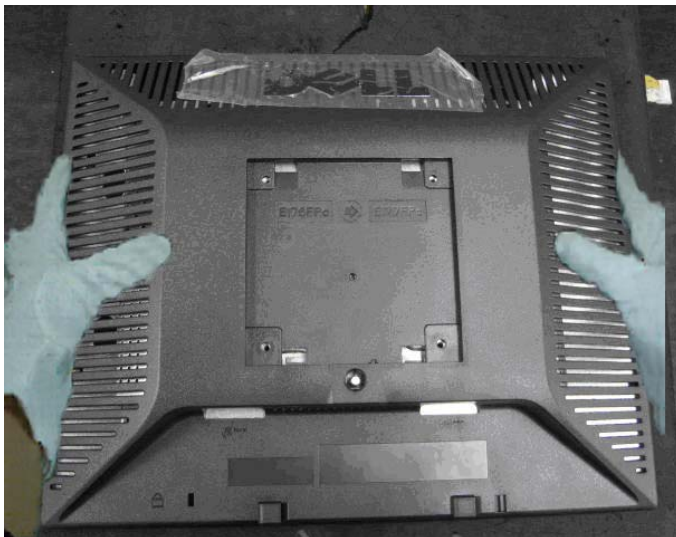

**Remove rear cover :**  
Turn over the monitor as the Fig,  
hold the rear cover, and then  
slightly remove it.

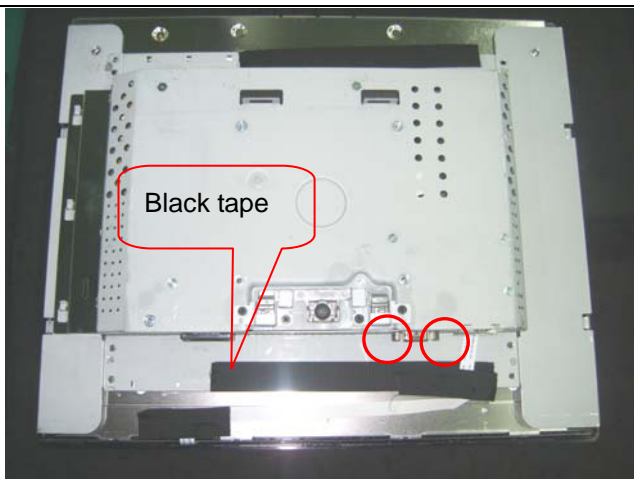

Remove the two screws by  
**Torque B**  
Install:  
Fix the keyboard cable by black  
tape as the figure showed.

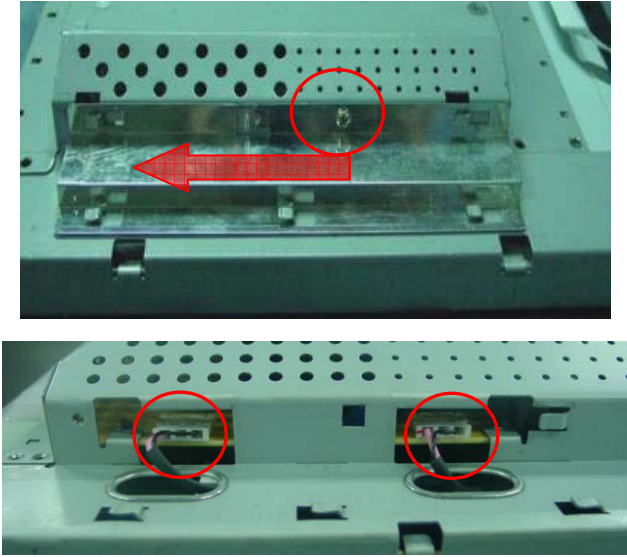
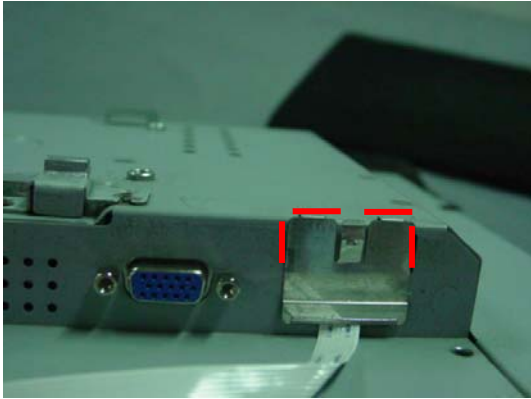
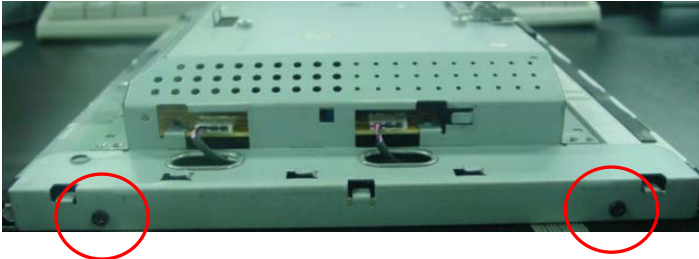
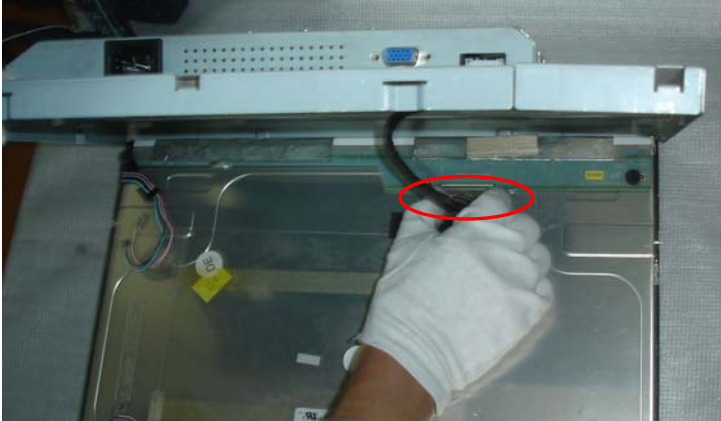

	<p><b>Remove the shield :</b></p> <p>1. Remove the screw by <b>Torque B</b> or by <b>manual</b> and remove the shield ,then remove the back light connector</p>
	<p>Remove the connector</p>
	<p>Remove the two screws by <b>manual</b> or <b>torque = 3kgF.Cm</b> and remove the main frame</p>
	<p>Remove the main frame and at the same time disconnect the LVDS connector and remove the EVA washers</p>

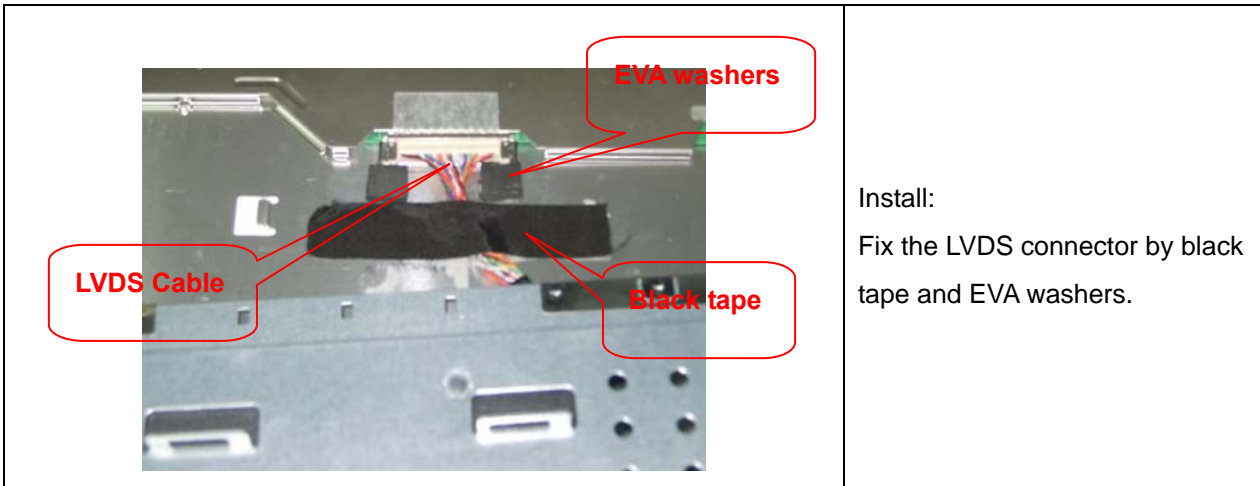

Install:  
Fix the LVDS connector by black tape and EVA washers.

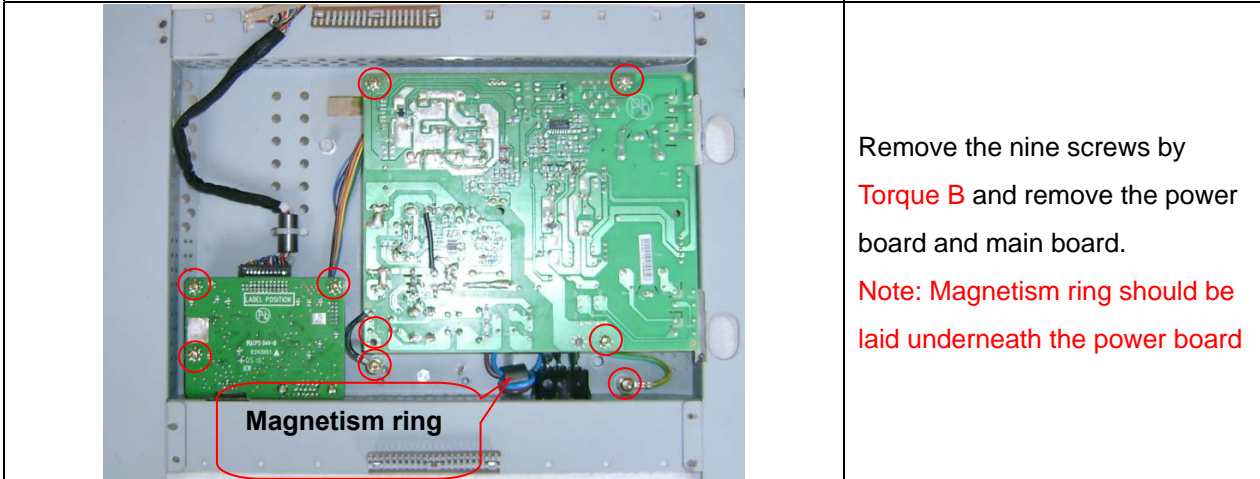

Remove the nine screws by **Torque B** and remove the power board and main board.  
**Note: Magnetism ring should be laid underneath the power board**

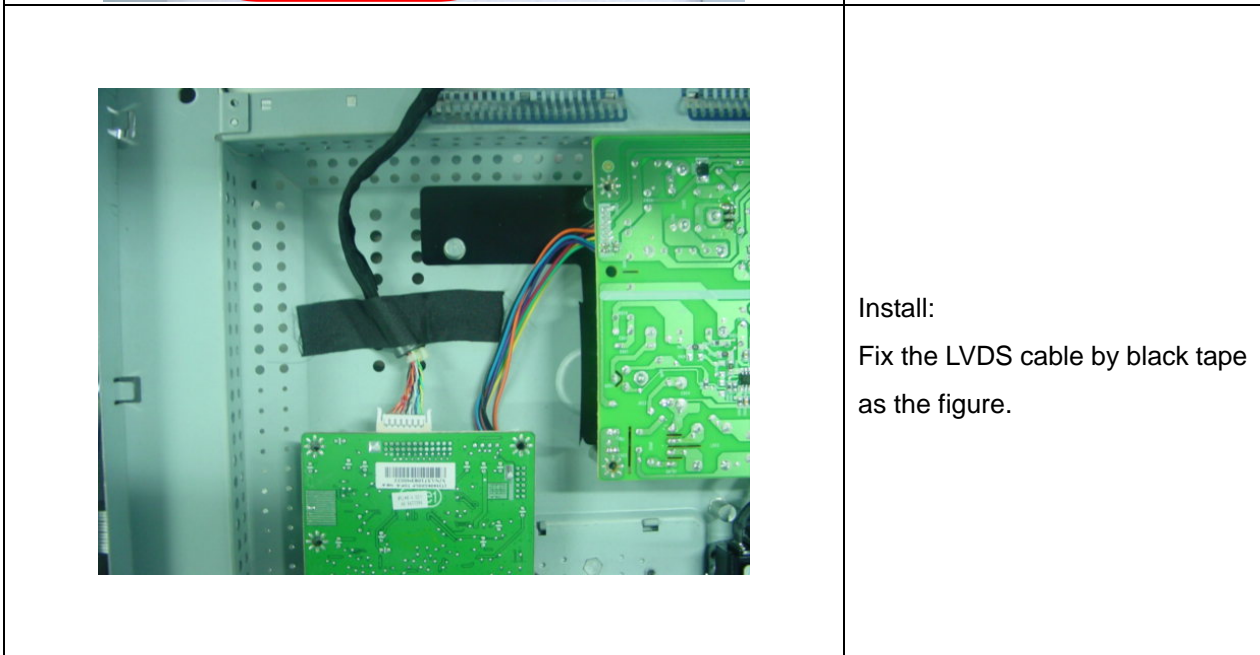

Install:  
Fix the LVDS cable by black tape as the figure.

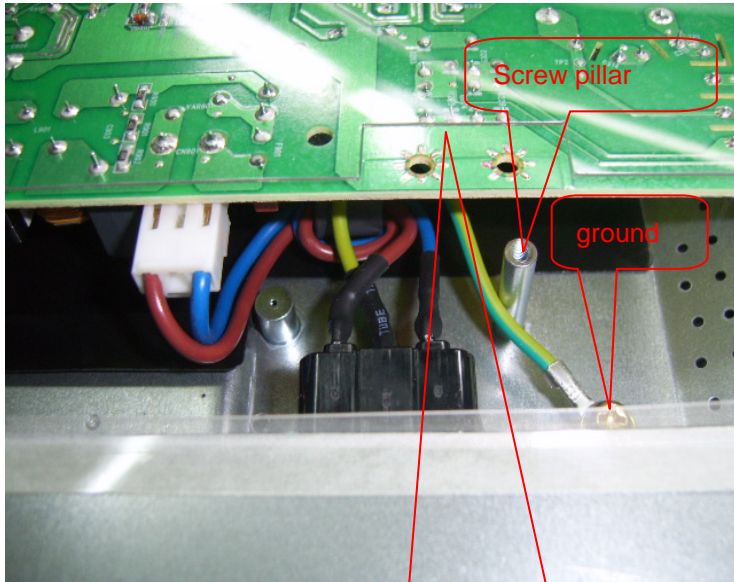

Screw AC ground line as the figure and should be laid at the left of screw pillar.

**Note:** The green line can't be pressed under the power board.

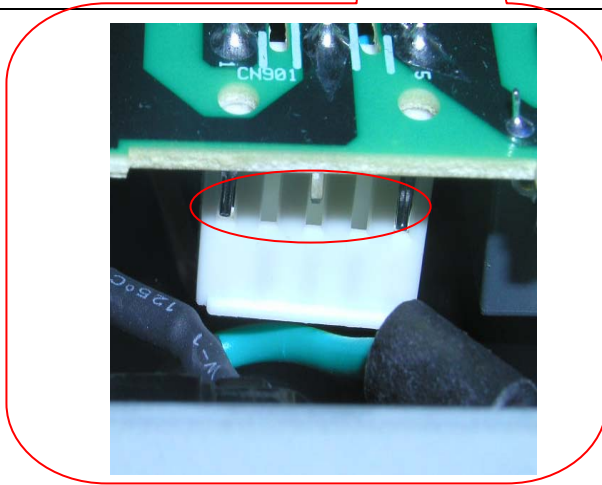

**Note:** The pins can't gore the blue and purple lines.



**The end**

# 7. Schematic Diagram

## 7.1 Main Board

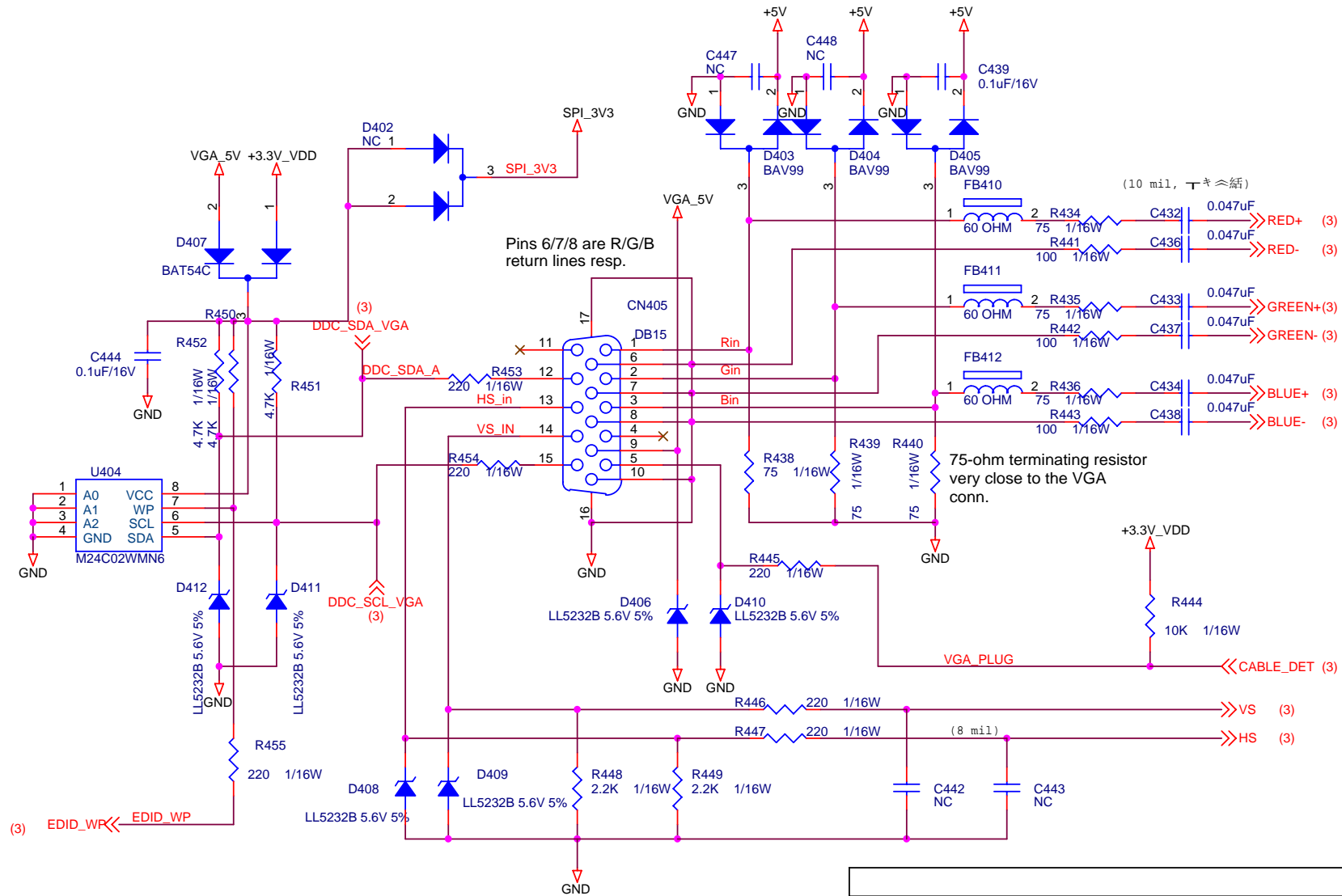

Title		
<b>Input Connectors</b>		
Size	Document Number	Rev
A		<b>D</b>
Date:	Wednesday, June 29, 2005	Sheet 2 of 6

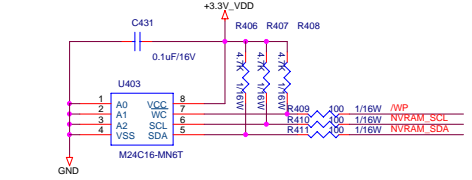
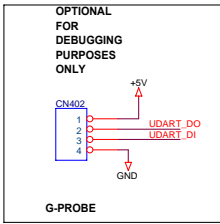
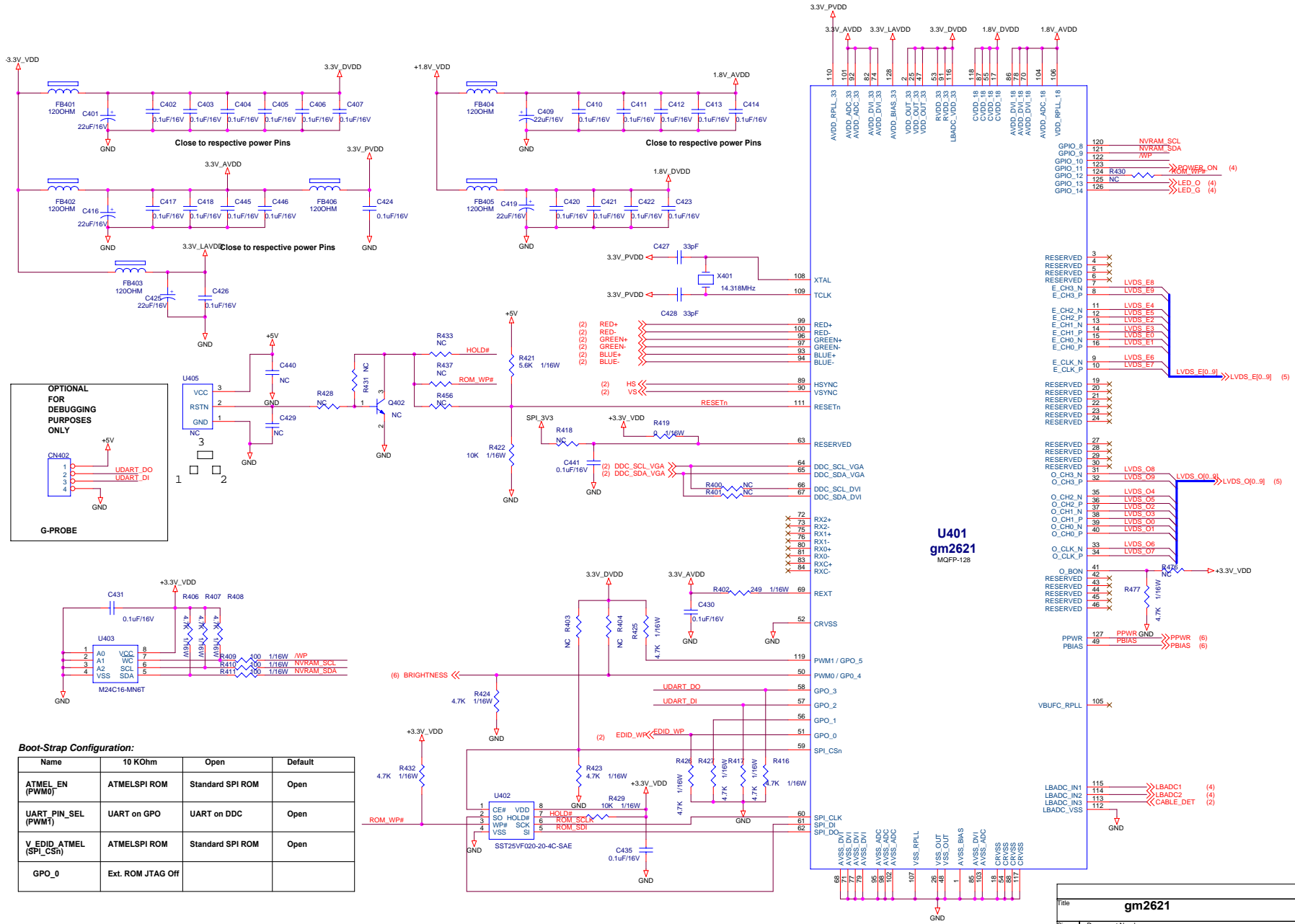

**Boot-Strap Configuration:**

Name	10 Kohm	Open	Default
ATMEL_EN (PWM0)	ATMELSPI ROM	Standard SPI ROM	Open
UART_PIN_SEL (PWM1)	UART on GPO	UART on DDC	Open
V EDID_ATMEL (SPI_CS#)	ATMELSPI ROM	Standard SPI ROM	Open
GPO_0	Ext. ROM JTAG Off		

Title		<b>gm2621</b>	
Size	Document Number		Rev
Custom			D
Date:	Wednesday, June 29, 2005	Sheet	3 of 6

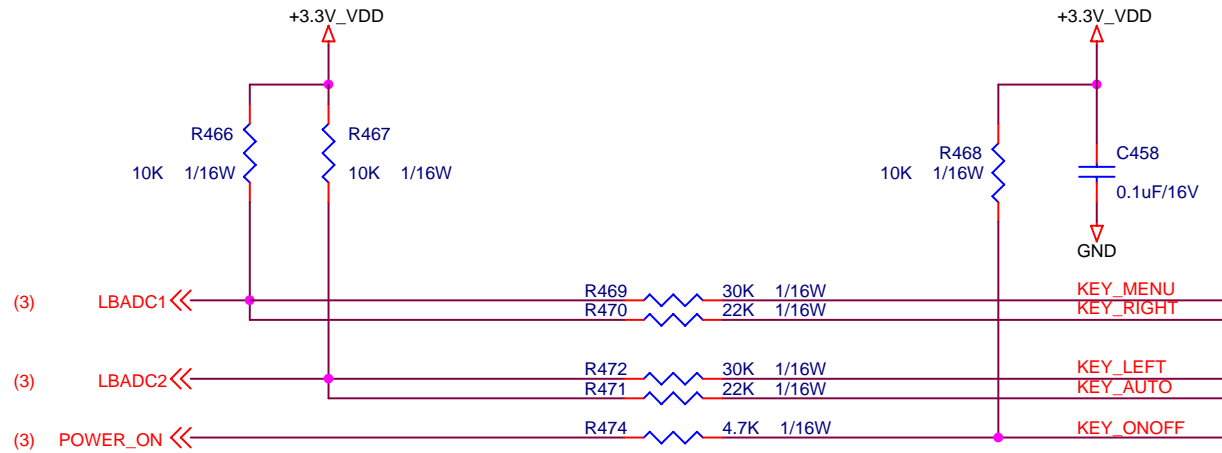
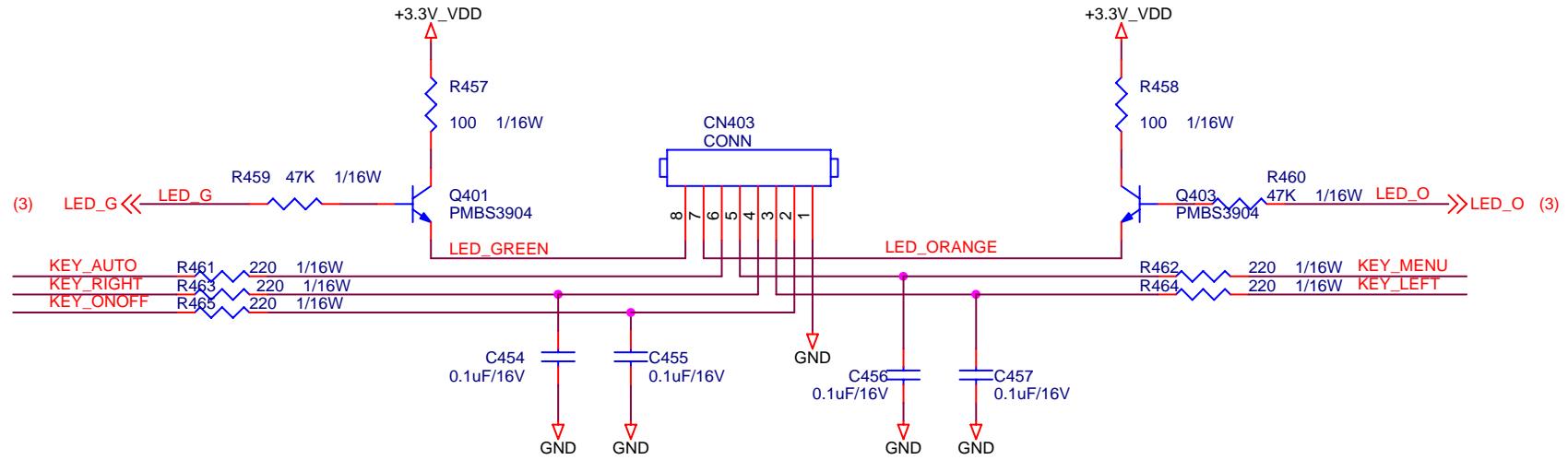

Title		
<b>KEYPAD</b>		
Size A	Document Number	Rev <b>D</b>
Date:	Wednesday, June 29, 2005	Sheet 4 of 6



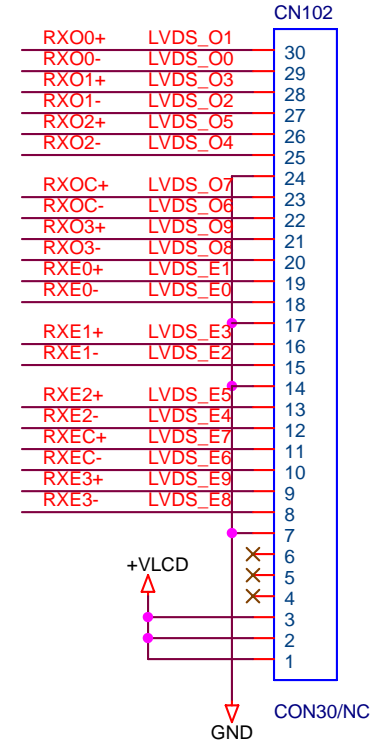
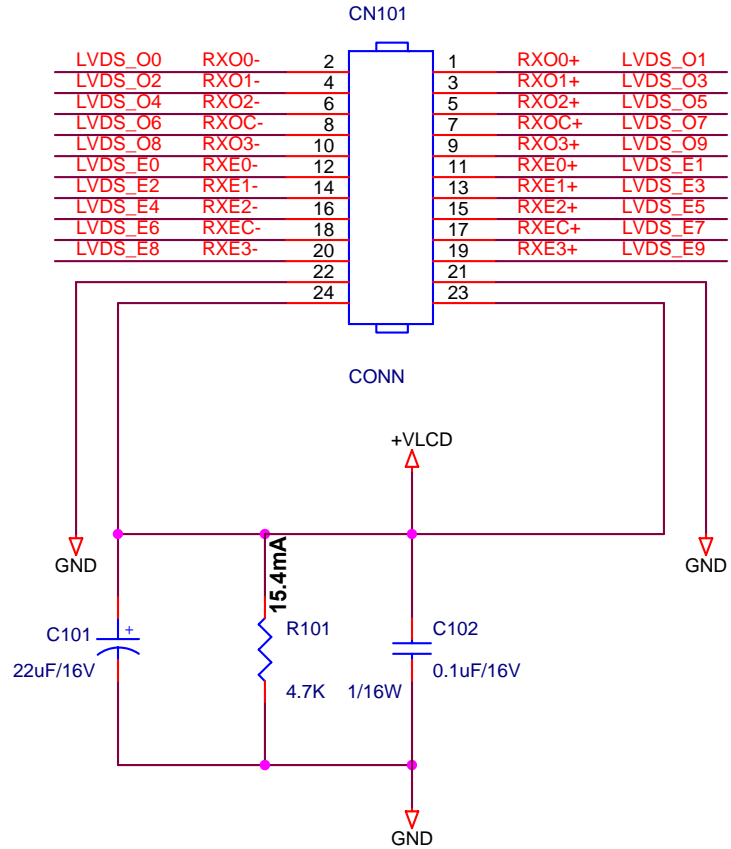
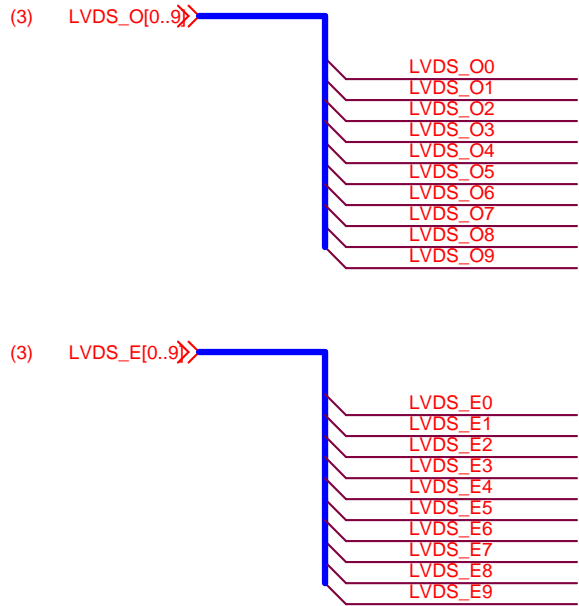

Title		
<b>PANEL INTERFACE</b>		
Size A	Document Number	Rev <b>D</b>
Date:	Wednesday, June 29, 2005	Sheet 5 of 6

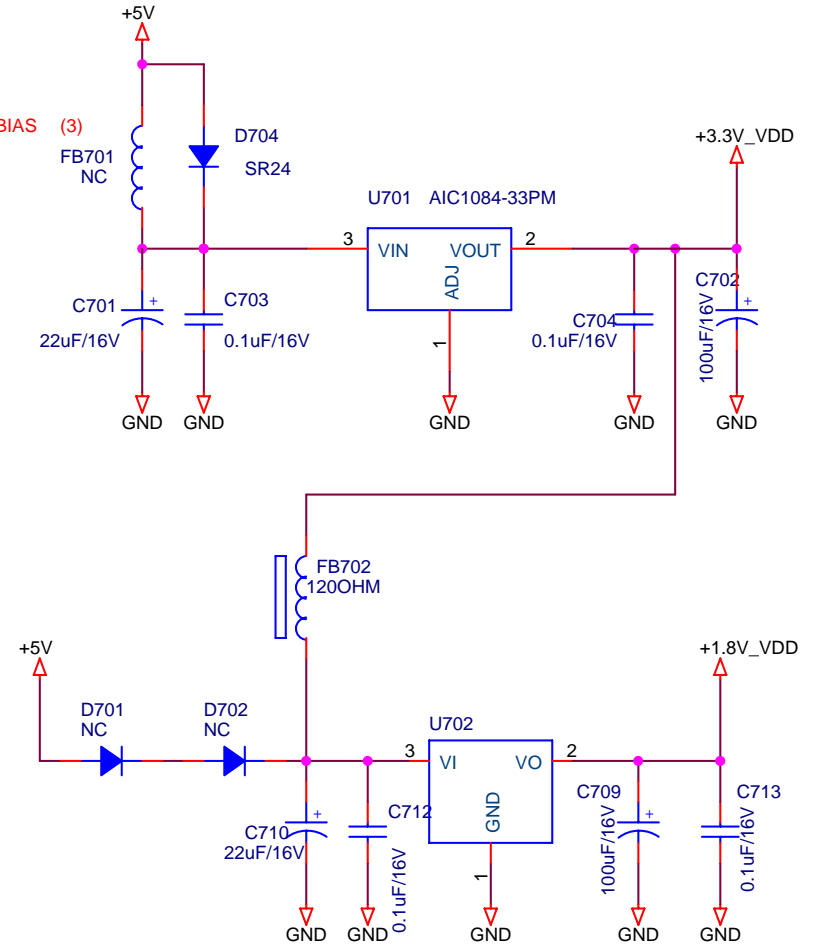
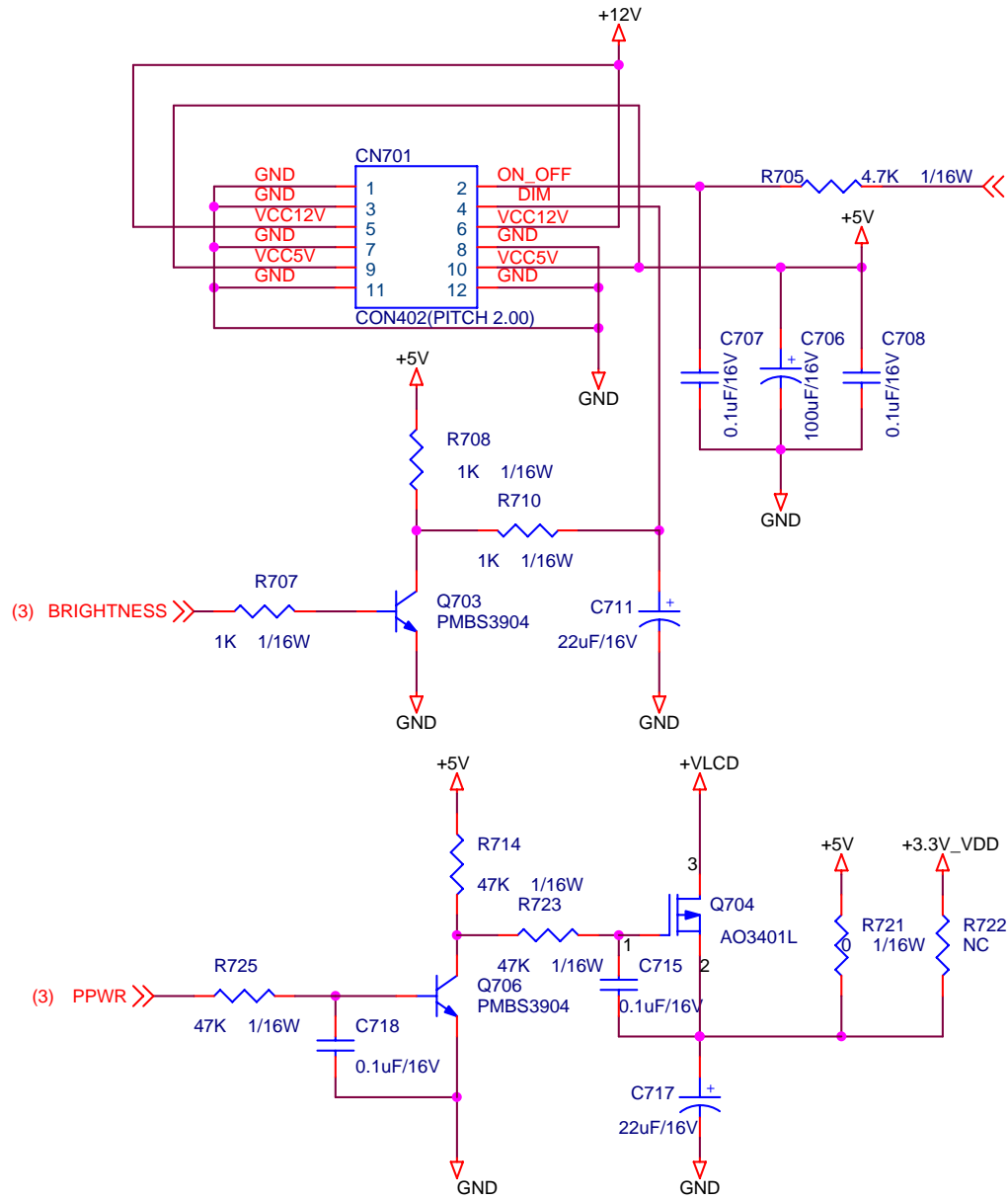

Title		
<b>POWER</b>		
Size A	Document Number	Rev D
Date:	Wednesday, June 29, 2005	Sheet 6 of 6



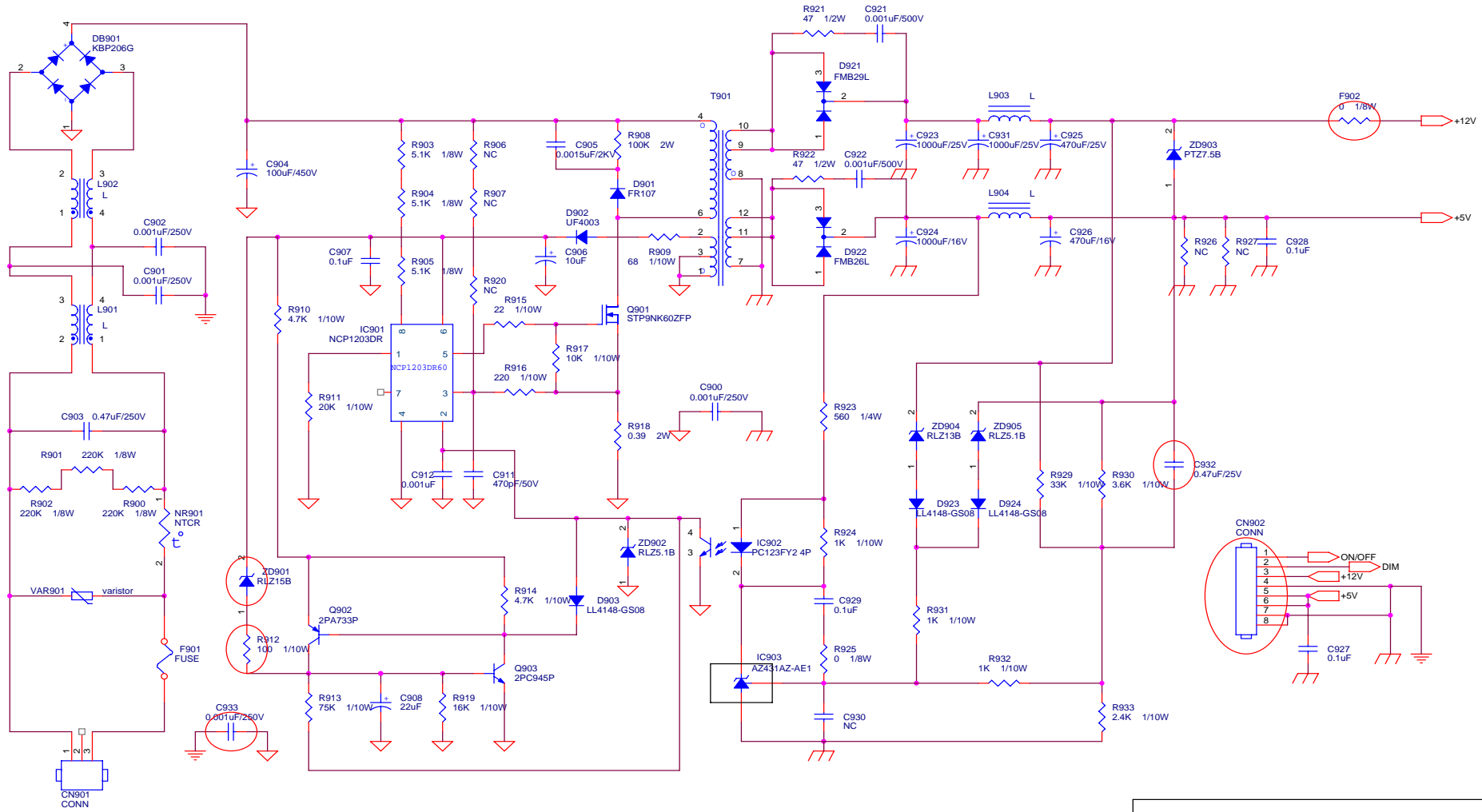

7.2 Power Board

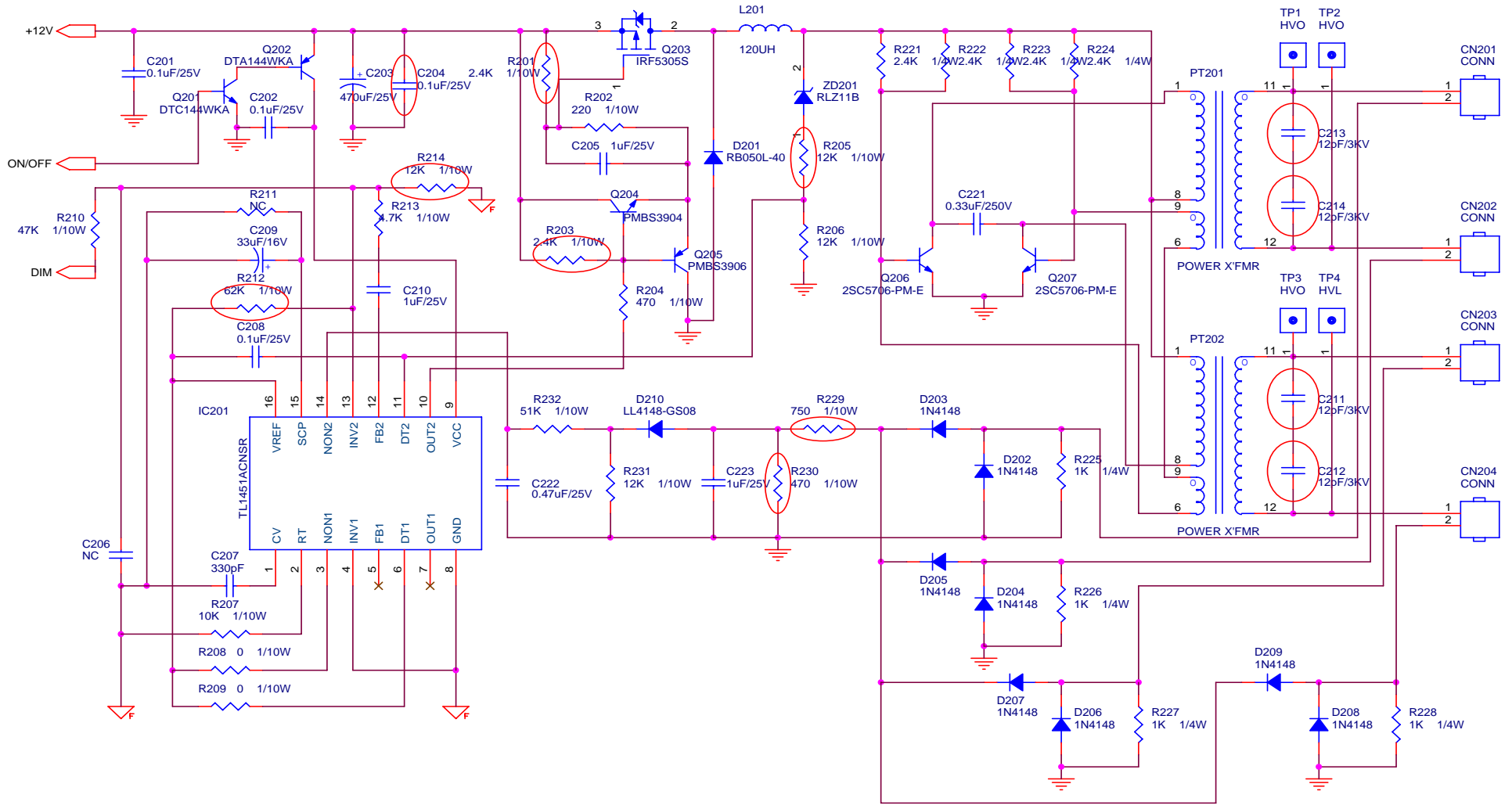

<b>AOC (Top Victory) Electronics Co., Ltd.</b>		
Title <b>1. POWER OUTPUT 12V &amp; 5V</b>		
Size B	Document Number <b>PWPC1742SE11 (715L1492-E)</b>	Rev A
Date: Wednesday, March 09, 2005	Sheet 1	of 2



AOC (Top Victory) Electronics Co., Ltd.		
Title <b>2. FOR 17" 4 LAMPS INVERTER</b>		
Size	Document Number <b>PWPC1742SEI1(715L1492-E)</b>	Rev A
Date: Wednesday, March 09, 2005	Sheet 2 of 2	

 is power GND  
 is signal GND



# 8. PCB Layout

## 8.1 Main Board

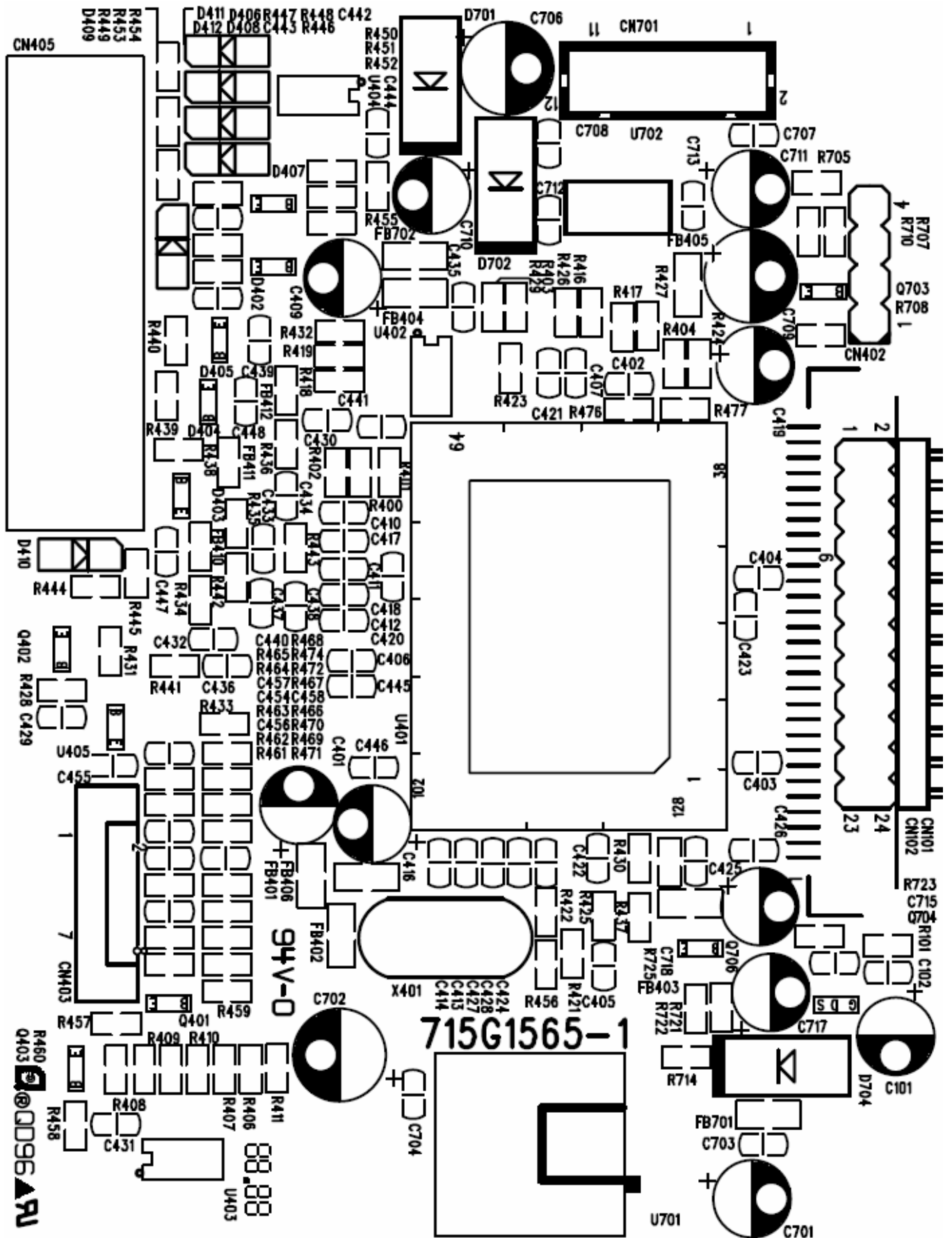

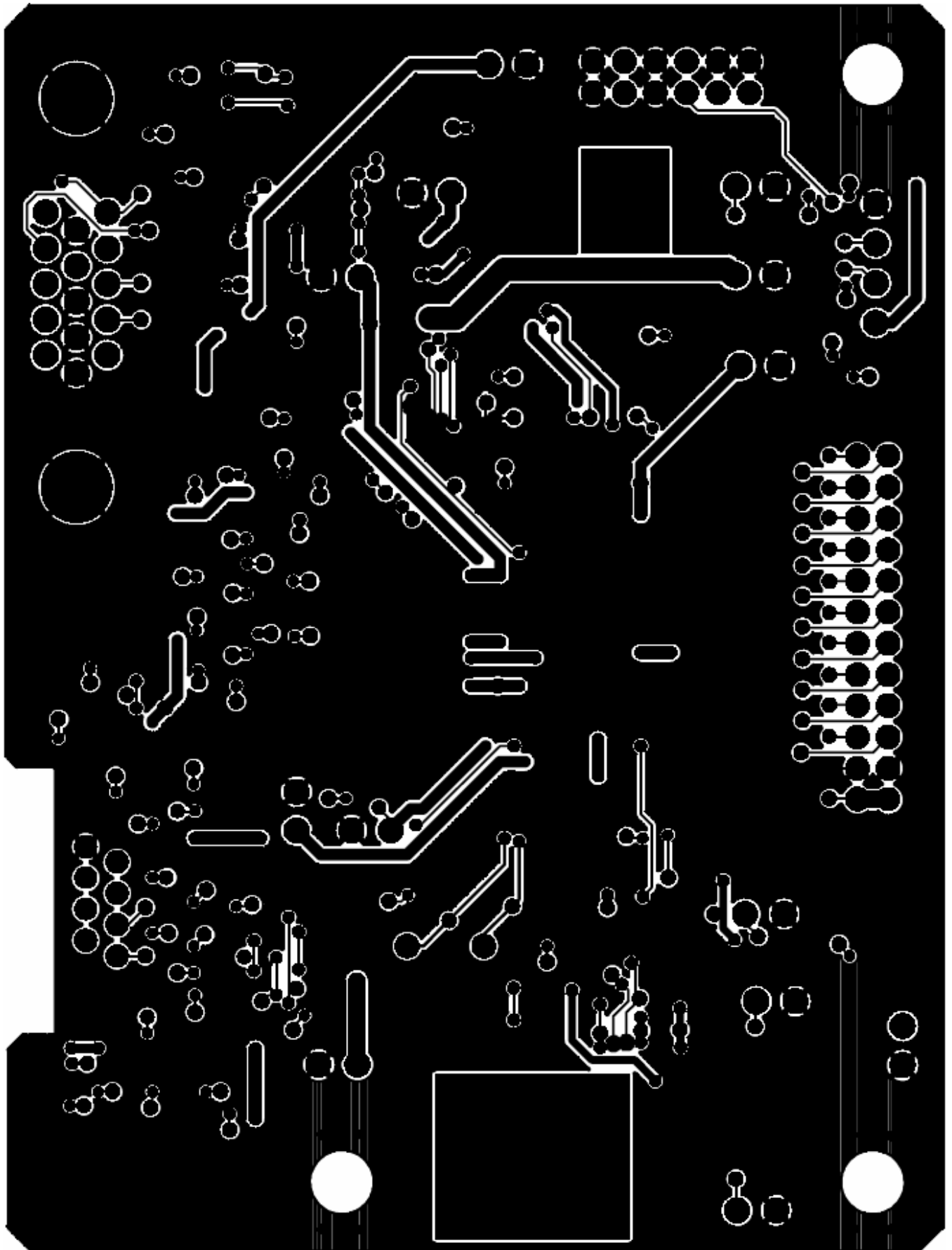

8.2 Inverter/Power Board

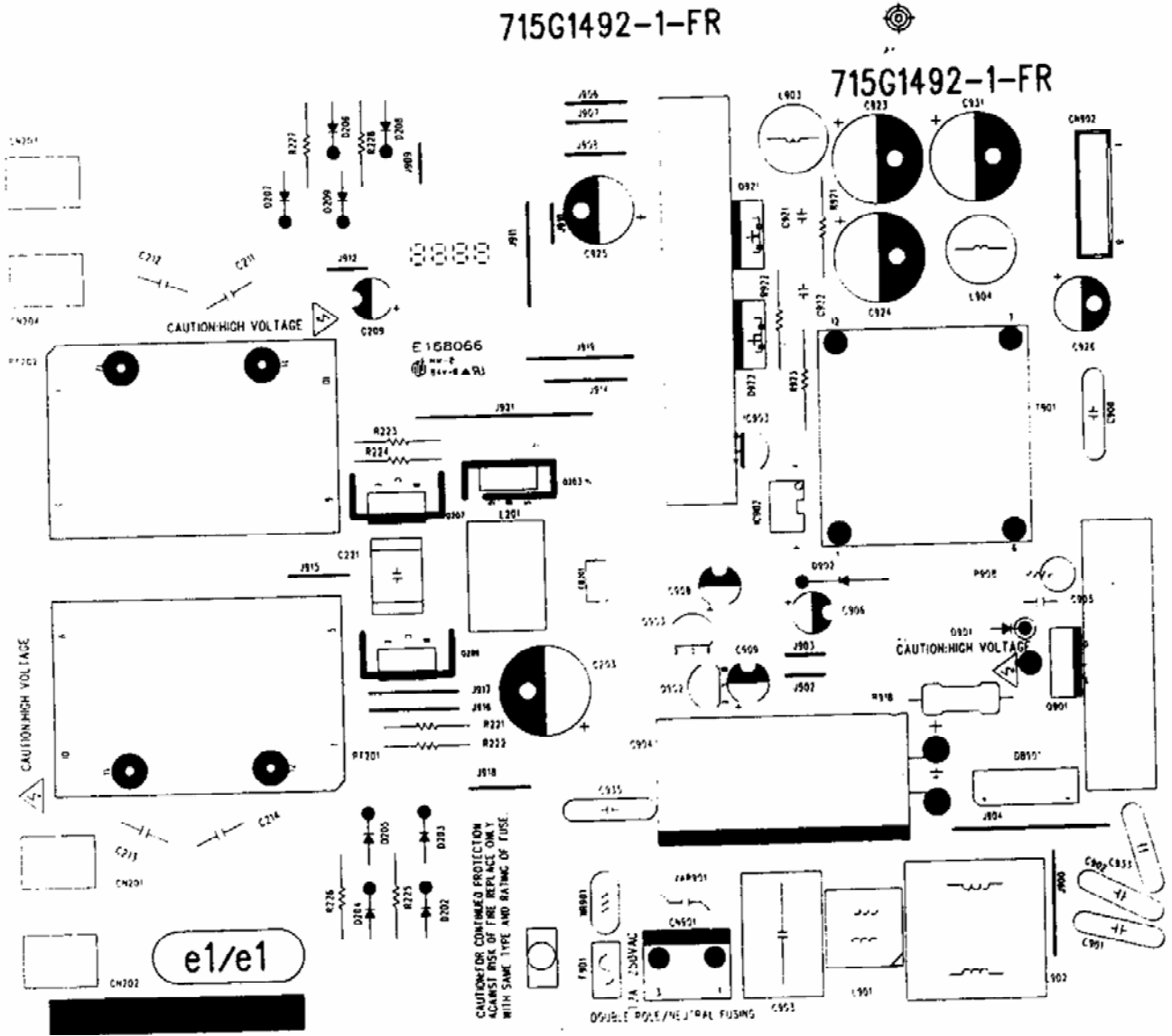

715G1492-1-FR

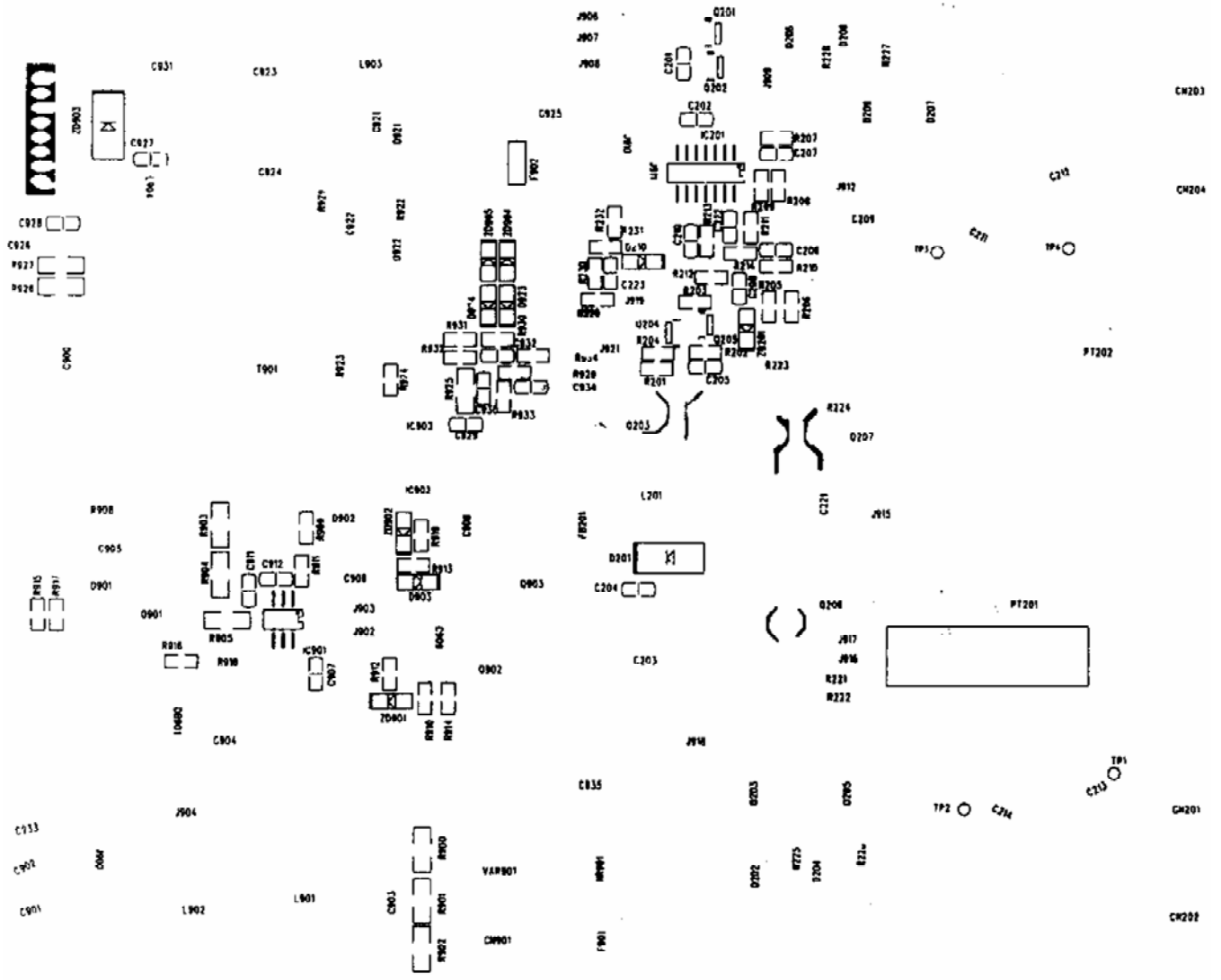

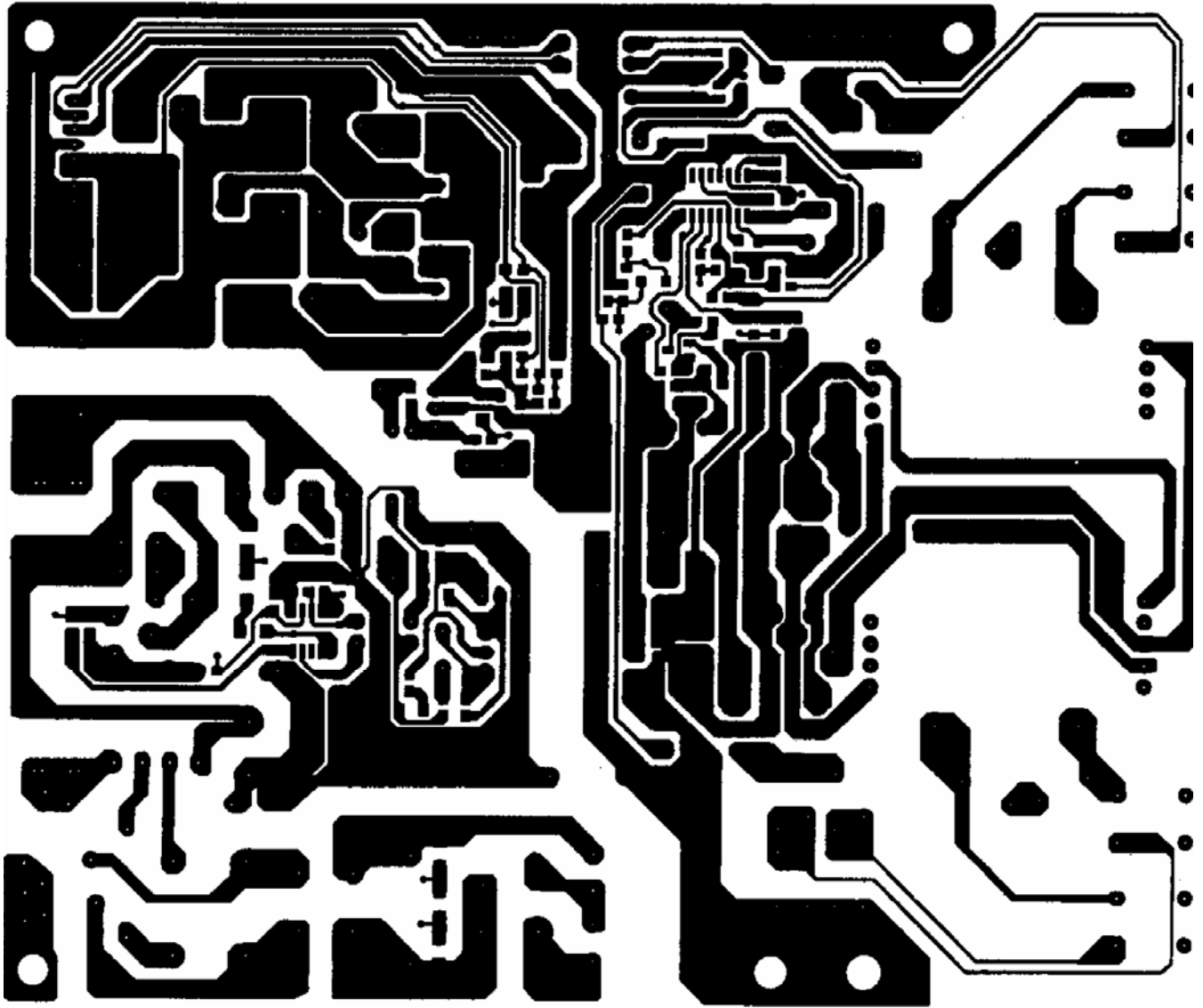

### 8.3 Key Board





## **9. Maintainability**

### **9.1 Equipments and Tools Requirement**

1. Voltage meter
2. Oscilloscope
3. Pattern Generator
4. LCD Color Analyzer
5. Service Manual
6. User Manual

## 9.2 Trouble shooting

### 9.2.1 Main Board

#### No display

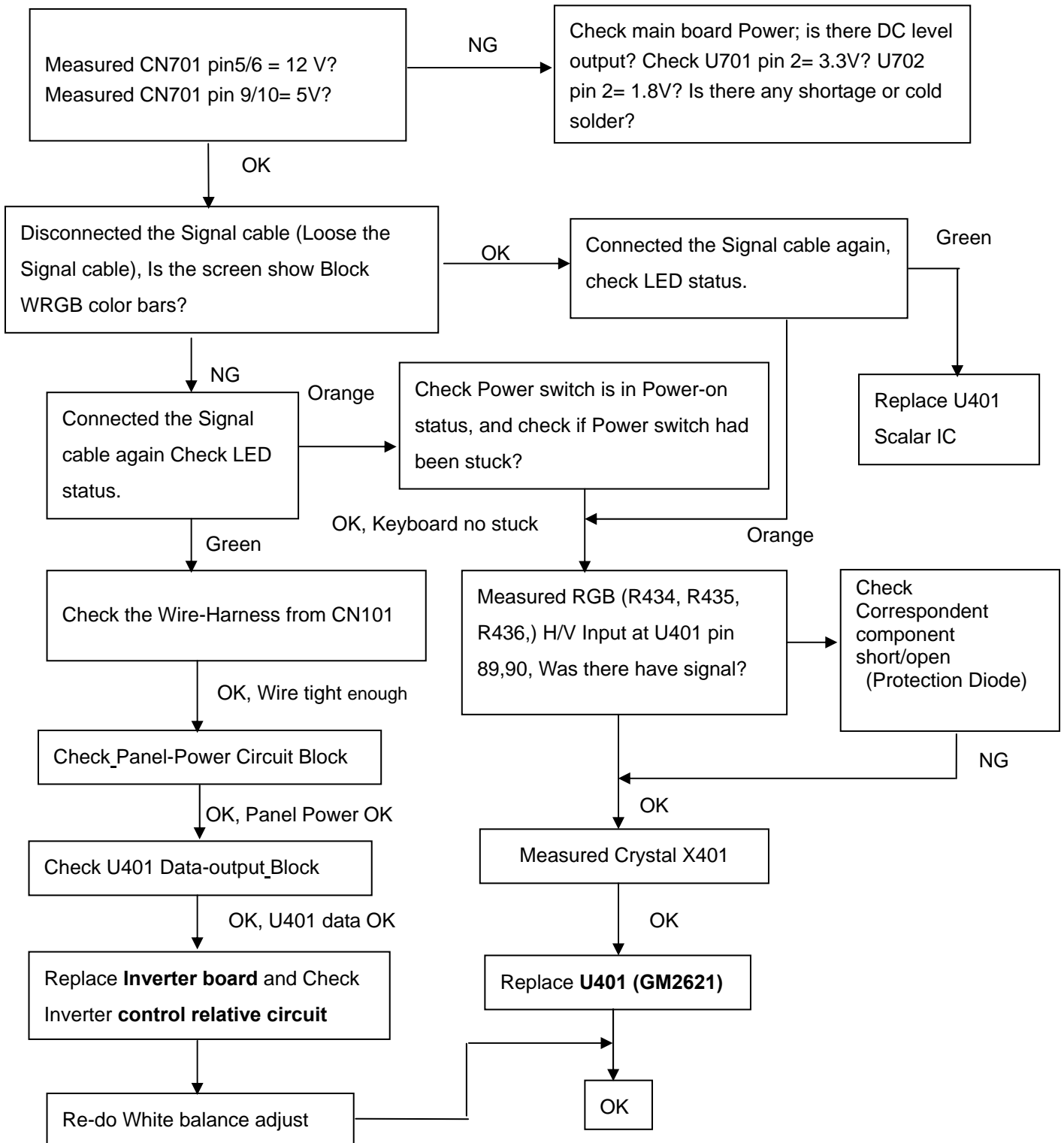

**Note:** 1. If replace “Main-Board”, Please re-do “DDC-content” programmed & “White-Balance”.

2. If replace “Power Board” only, Please re-do “White-Balance”.

**Panel Power Circuit**

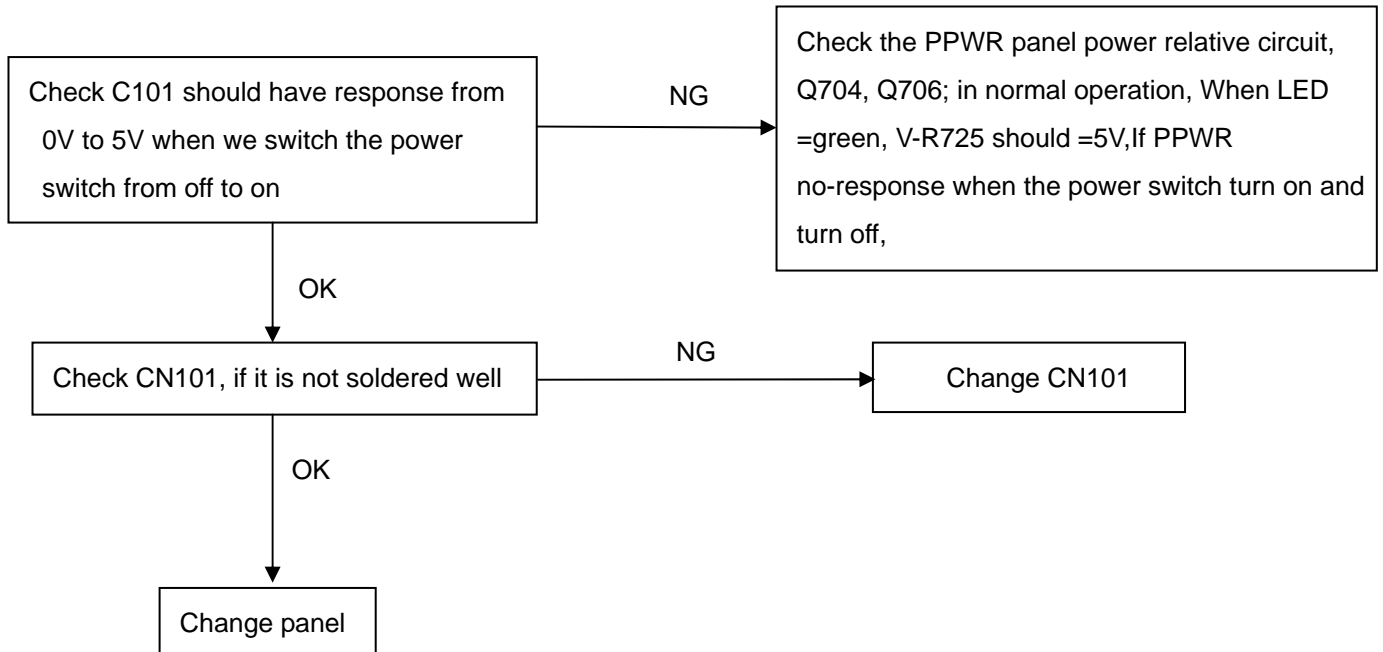

**Inverter Control Relative Circuit**

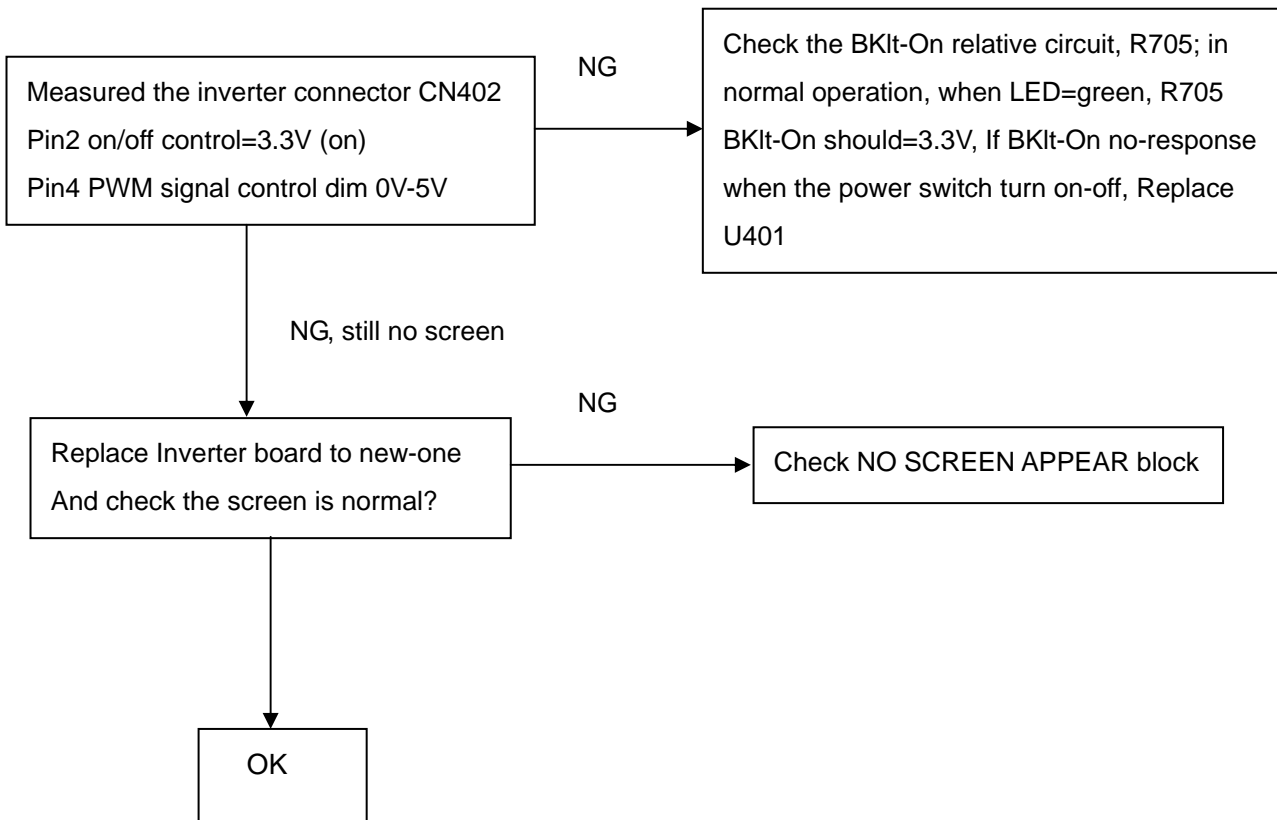

U401-data Output

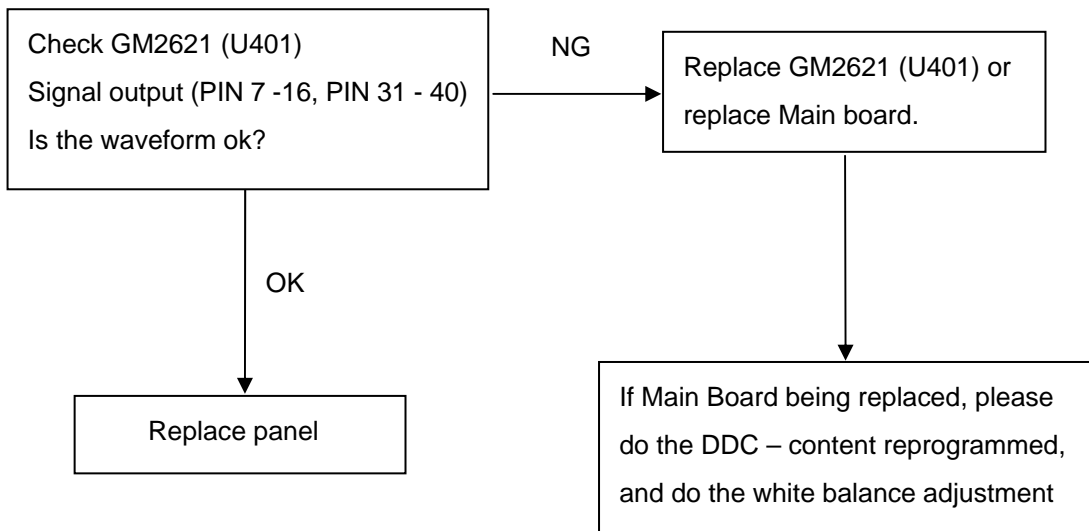

### 9.2.2 Inverter/Power Board

#### No Power

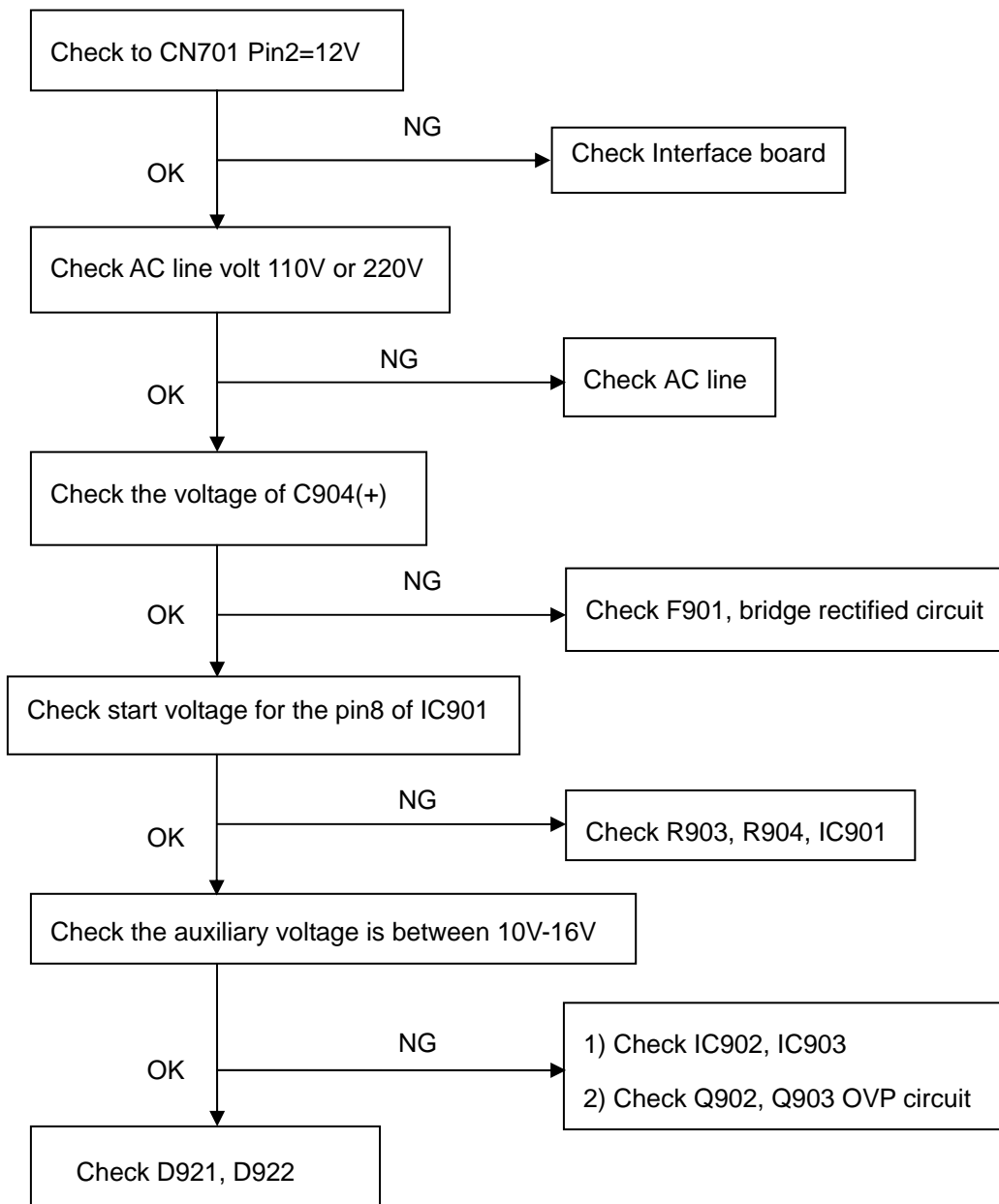

No Backlight

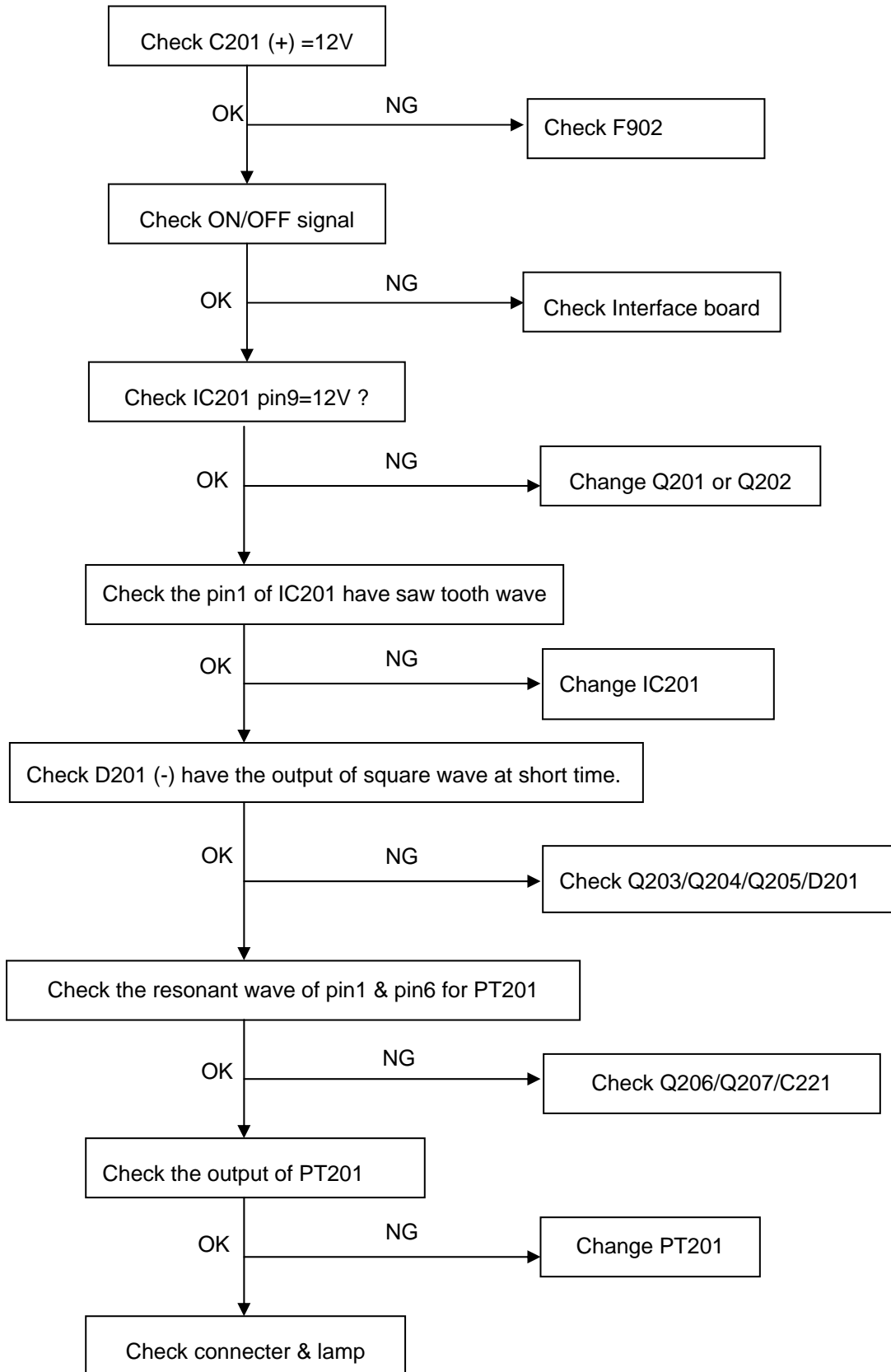

### 9.2.3 Key Board

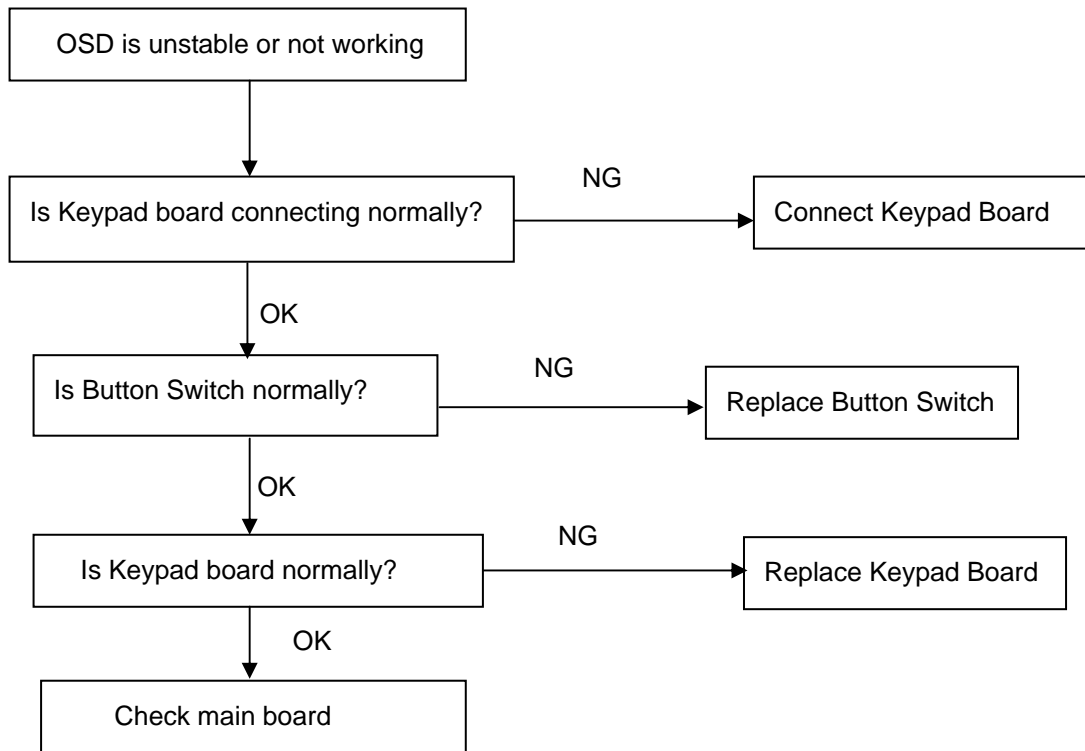

## 10. White balance, Luminance adjustment

**Approximately 2 Hours should be allowed for warm up before proceeding White-Balance adjustment.**

Before started adjust white balance, please setting the Chroma-7120 **MEM. Channel 3 to 6500<sup>0</sup>K** colors, **MEM. Channel 4 to 9300<sup>0</sup>K** colors, **MEM. Channel 9 to 5700<sup>0</sup>K** (our 9300 parameter is  $x=283\pm 28$ ,  $y=297\pm 28$ ,  $Y = 175 \pm 20 \text{ cd/m}^2$ , 6500 parameter is  $x = 313\pm 28$ ,  $y=329\pm 28$ ,  $Y = 180 \pm 20 \text{ cd/m}^2$ , and 5700 parameter is  $x = 328 \pm 28$ ,  $y = 344 \pm 28$ ,  $Y = 180 \pm 20 \text{ cd/m}^2$ )

How to setting MEM.channel you can reference to chroma 7120 user guide or simple use “**SC**” key and “**NEXT**” key to modify xyY value and use “**ID**” key to modify the TEXT description Following is the procedure to do white-balance adjust

Press MENU and AUTO-ADJUST button during press Power button will activate the factory mode,

### Gain adjustment:

Move cursor to “-Factory Setting-” and press MENU key to enter this sub-menu.

Move cursor to “ Factory” and press MENU key.

Move cursor to “ Auto Level” and press MENU key to adjust Gain and Offset automatically;

#### a. Adjust sRGB (6500<sup>0</sup>K) color-temperature

1. Switch the chroma-7120 to **RGB-mode** (with press “MODE” button)
2. Switch the MEM.channel to Channel 3 (with up or down arrow on chroma 7120)
3. The LCD-indicator on chroma 7120 will show  $x = 313 \pm 28$ ,  $y = 329 \pm 28$ ,  $Y = 180 \pm 20 \text{ cd/m}^2$
4. Adjust the RED on OSD window until chroma 7120 indicator reached the value  $R=100$
5. Adjust the GREEN on OSD, until chroma 7120 indicator reached  $G=100$
6. Adjust the BLUE on OSD, until chroma 7120 indicator reached  $B=100$
7. Repeat above procedure (item 5,6,7) until chroma 7120 RGB value meet the tolerance  $=100\pm 2$

#### b. Adjust Color1 (9300<sup>0</sup>K) color-temperature

8. Switch the chroma-7120 to **RGB-mode** (with press “MODE” button)
9. Switch the MEM.channel to Channel 4 (with up or down arrow on chroma 7120)
10. The LCD-indicator on chroma 7120 will show  $x = 283 \pm 28$ ,  $y = 297 \pm 28$ ,  $Y = 175 \pm 20 \text{ cd/m}^2$
11. Adjust the RED on OSD window until chroma 7120 indicator reached the value  $R=100$
12. Adjust the GREEN on OSD, until chroma 7120 indicator reached  $G=100$
13. Adjust the BLUE on OSD, until chroma 7120 indicator reached  $B=100$
14. Repeat above procedure (item 5,6,7) until chroma 7120 RGB value meet the tolerance  $=100\pm 2$

#### c. Adjust Color2 (5700<sup>0</sup>K) color-temperature

15. Switch the chroma-7120 to **RGB-mode** (with press “MODE” button)
16. Switch the MEM.channel to Channel 9 (with up or down arrow on chroma 7120)
17. The LCD-indicator on chroma 7120 will show  $x = 328 \pm 28$ ,  $y = 344 \pm 28$ ,  $Y = 180 \pm 20 \text{ cd/m}^2$
18. Adjust the RED on OSD window until chroma 7120 indicator reached the value  $R=100$
19. Adjust the GREEN on OSD, until chroma 7120 indicator reached  $G=100$
20. Adjust the BLUE on OSD, until chroma 7120 indicator reached  $B=100$



21. Repeat above procedure (item 5,6,7) until chroma 7120 RGB value meet the tolerance =100±2

22. Move cursor to “ Exit/Save” sub-menu and press MENU key to save adjust value and exit.

**Turn the POWER-button off to on to quit from factory mode.**

### Max Brightness measurement:

- a. Switch to the full white pattern, in user mode main menu:
  1. Set <Color Settings> Red, Green, and Blue to the max.
  2. Set <Brightness> Brightness, Contrast to the max.
- b. The Minimum brightness is 200cd/m<sup>2</sup> ±20

## 11. EDID Content

	00	01	02	03	04	05	06	07	08	09	10	11	12	13	14	15
0:	00	FF	FF	FF	FF	FF	FF	00	10	AC	14	A0	30	39	37	38
16:	0D	0F	01	03	68	22	1B	78	EE	CA	F6	A3	57	47	9E	23
32:	11	4F	54	A5	4B	00	71	4F	81	80	01	01	01	01	01	01
48:	01	01	01	01	01	01	30	2A	00	98	51	00	2A	40	30	70
64:	13	00	52	0E	11	00	00	1E	00	00	00	FF	00	39	30	31
80:	32	33	35	34	36	38	37	39	30	0A	00	00	00	FC	00	44
96:	45	4C	4C	20	45	31	37	36	46	50	0A	20	00	00	00	FD
112:	00	38	4B	1F	50	0E	00	0A	20	20	20	20	20	20	00	4B

Note: Byte 0C, 0D, 0E, 0F means Serial No. Byte 10, 11 means manufacture time. Byte 7F means checksum

## 12. ISP (In System Program) User Manual

### 12.1 Connect ISP Writer preparation action

Connect RXD and TXD of PC to RXD (P3.0) and TXD (P3.1) of CPU through RS-232.

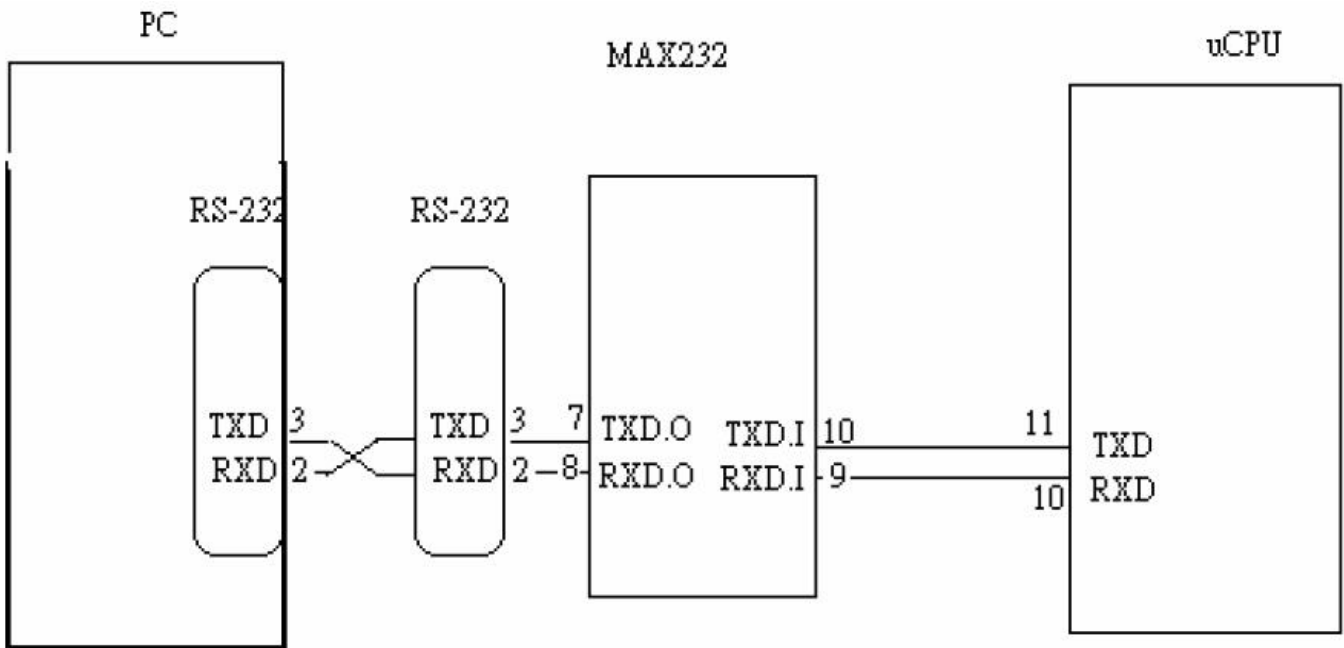

a. There are two ways to entering Reboot Mode. The settings for Reboot Mode is as follow

- Both P2.6 P2.7 are LOW and RESET pin is HIGHT.
- P4.3 is LOW and RESET pin is HIGHT.

## 12.2 To Use ISP WRITER (take E153FP for example)

Press the “-“ key at front bezel and plug the AC power cord in, then the MCU enter ISP mode;

a. You will enter the window as follow after executing the ispwriter.exe file.

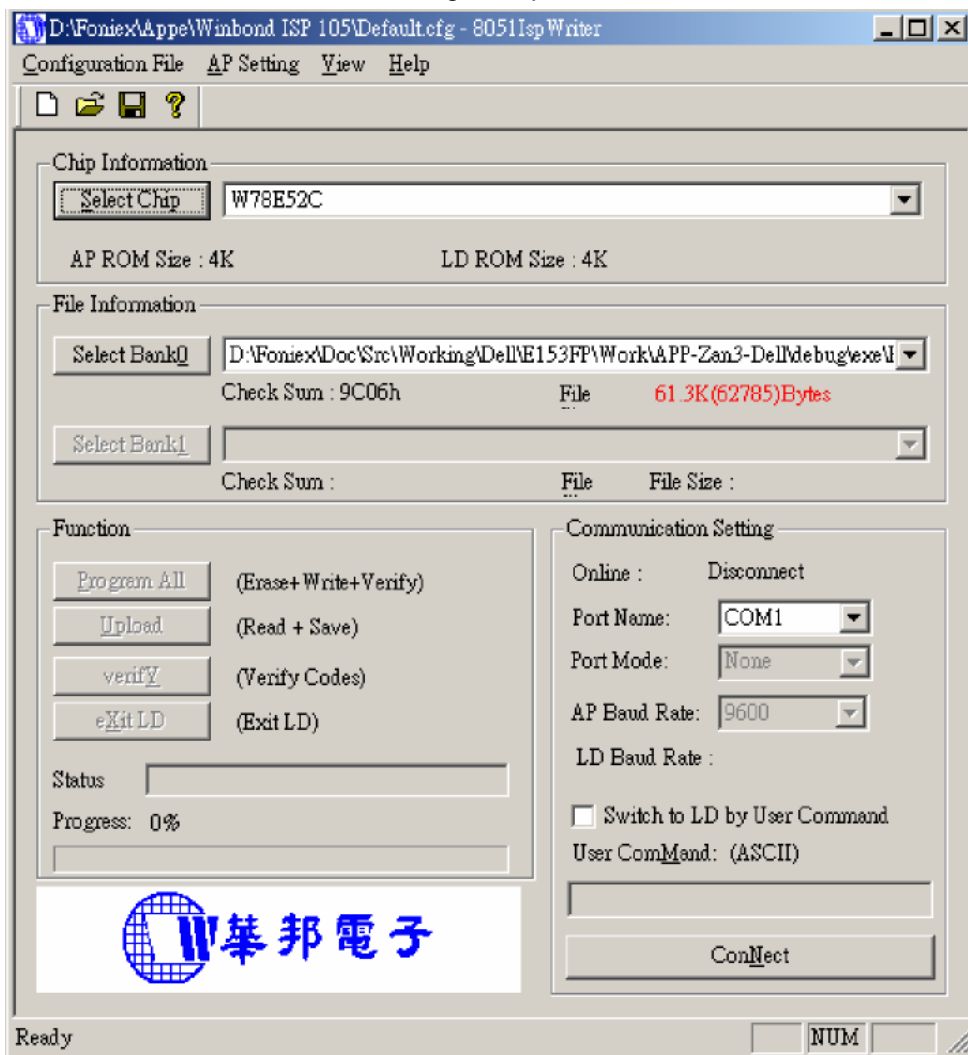

b. Click the "Select Chip" button, and choose the type you're going to program.

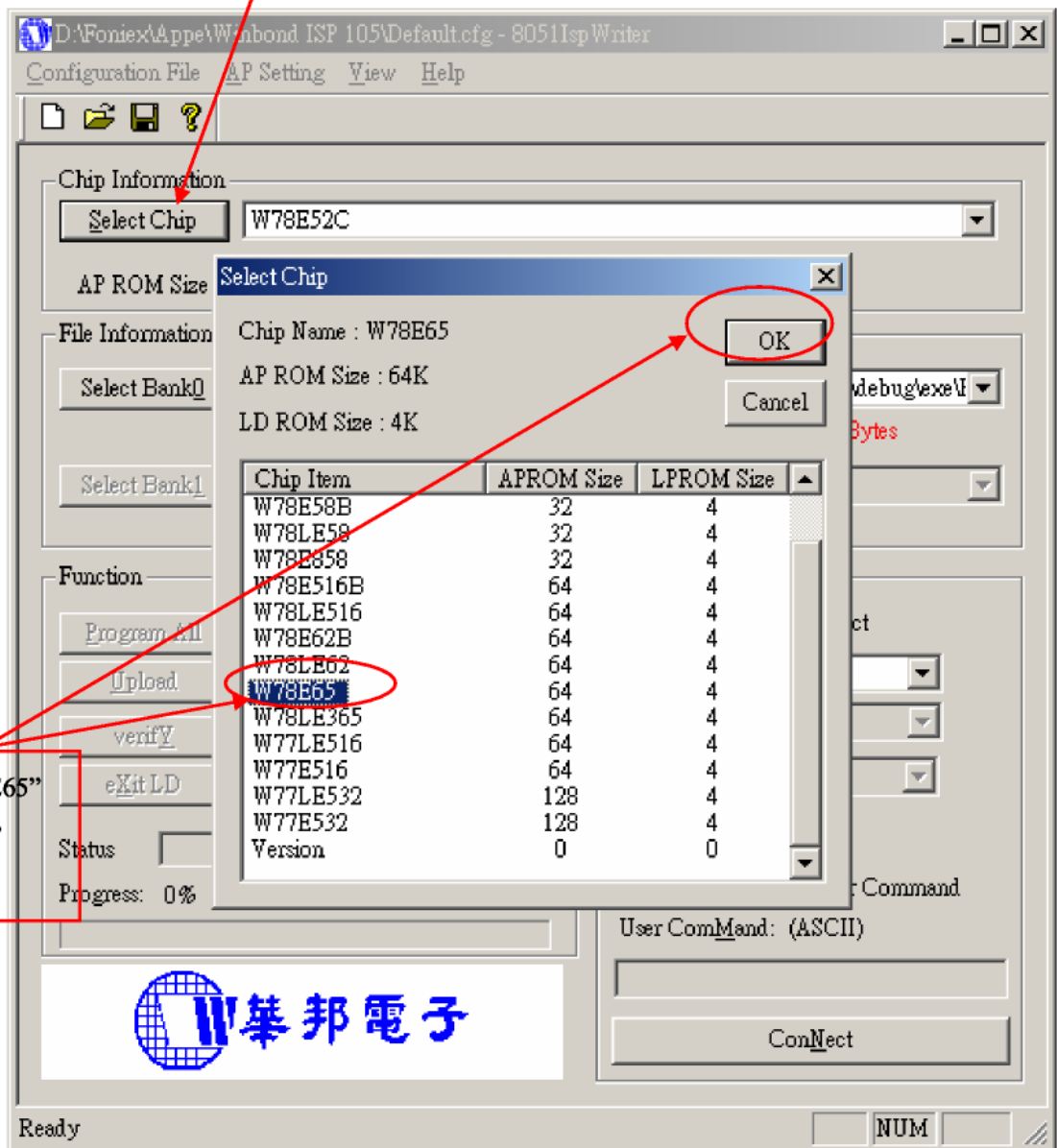

c. Click the "Select Bank0" button and selecting a file which a binary Format required.

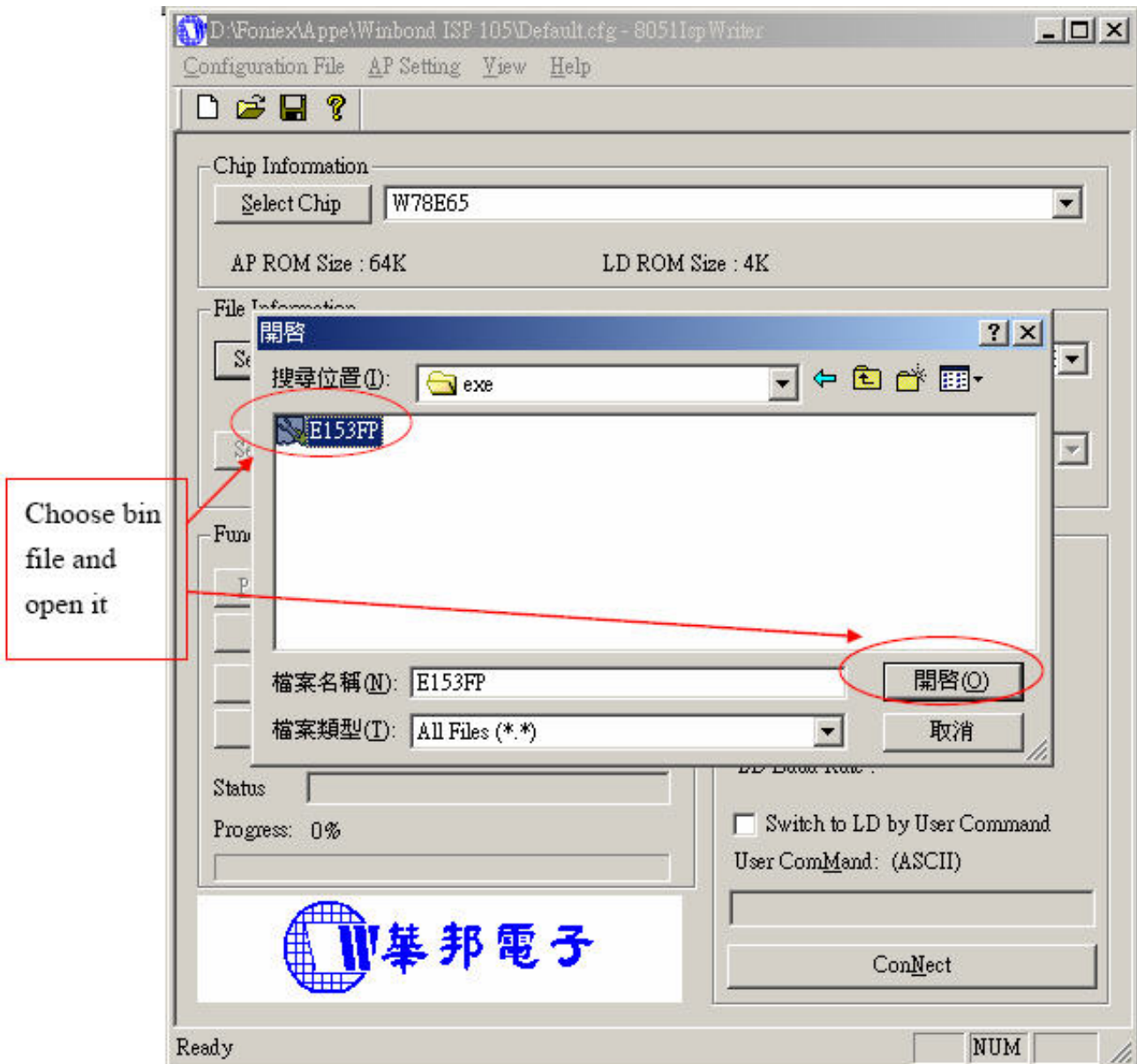

d. Select the communication Setting: Port Name

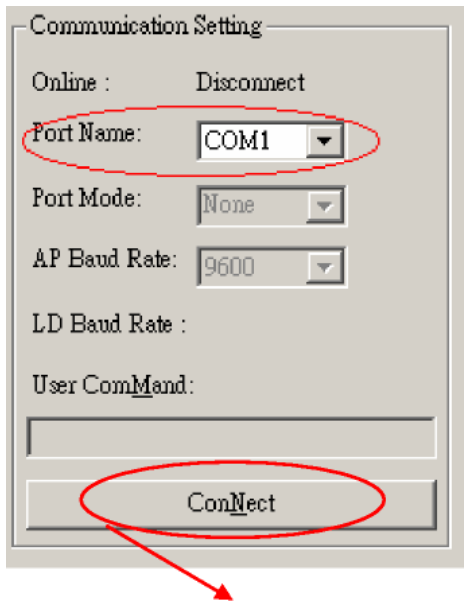

e. Click the "ConNect" button.

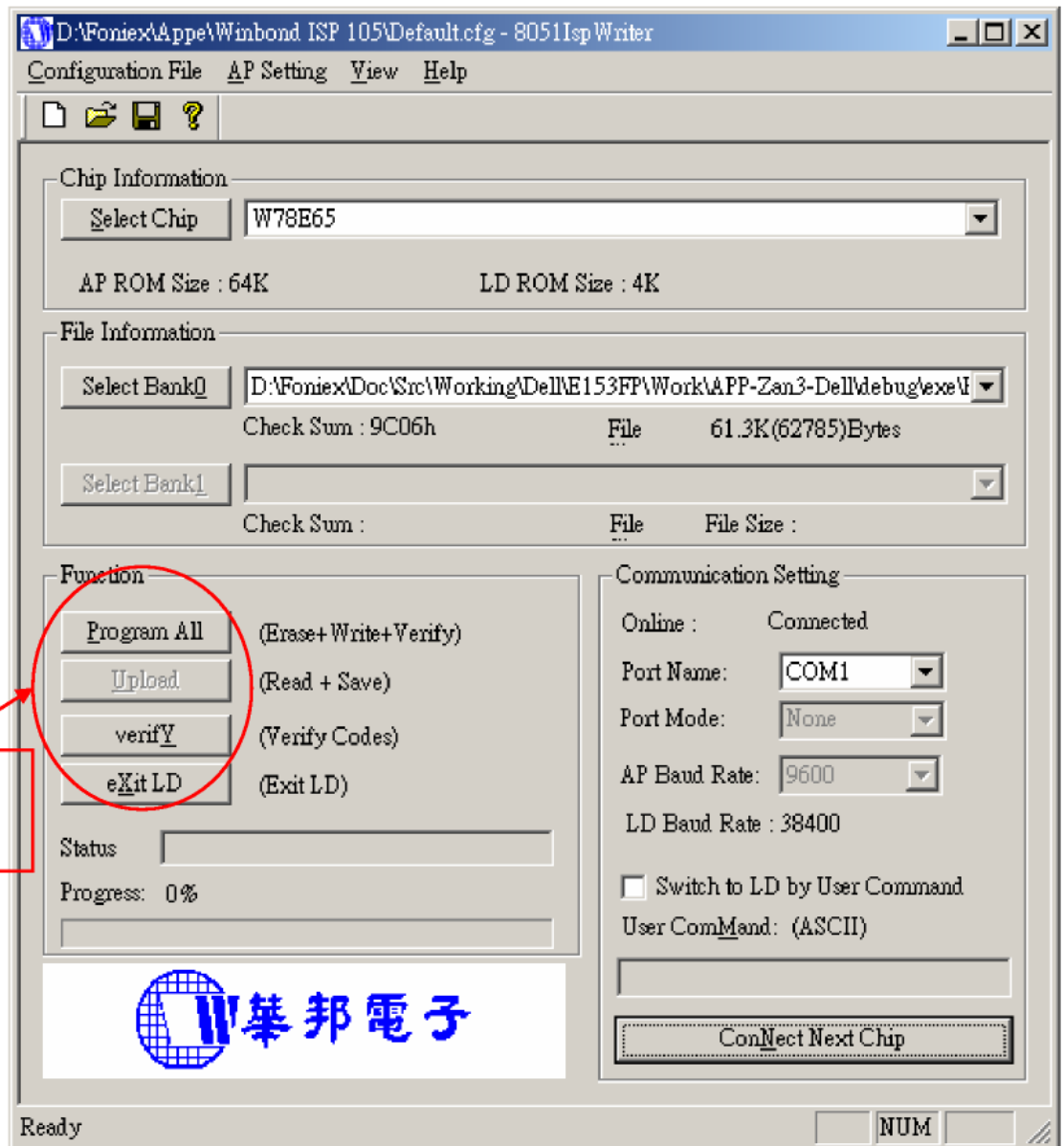

f. Click "Program all" to start programming.

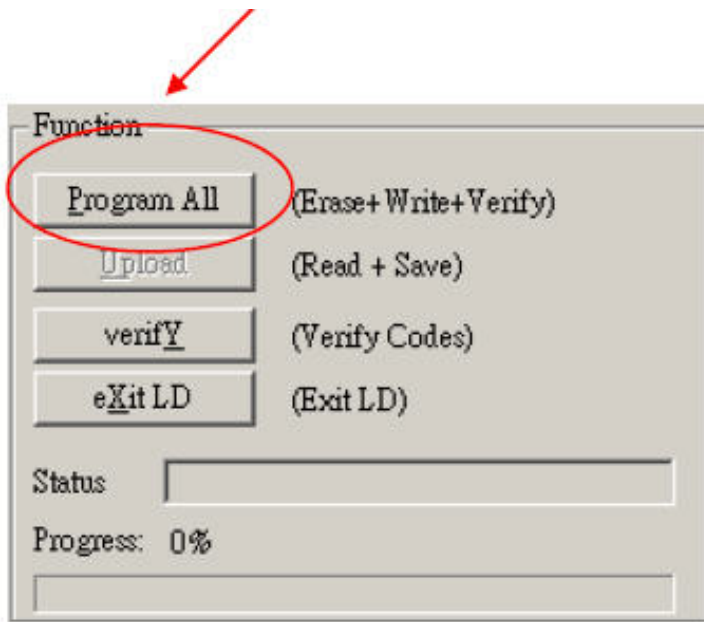

### 12.3. Executing ISP

a. "Program All" button that will execute erase and program and verify. Then you can get the window as follow, and click "OK" to complete ISP process.

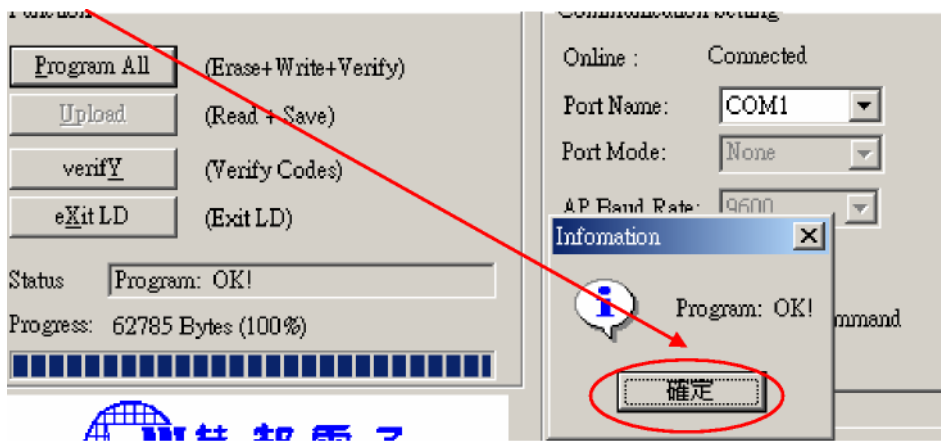

b. Complete the ISP process, click "exit LD" button to reset monitor.

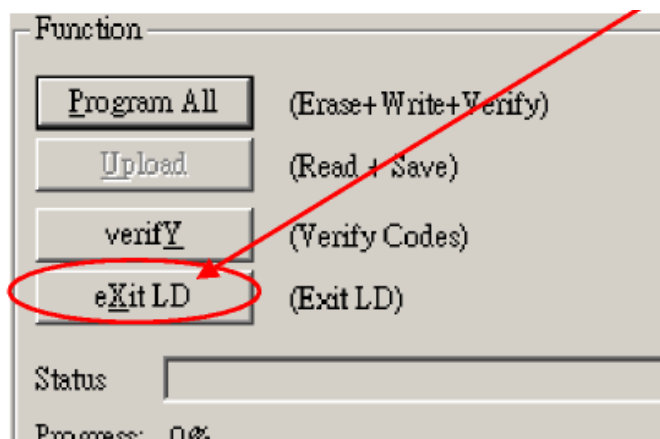

## 13. Check List

- 1) After replacing LCD Main board and panel, Check if white-balance is within the specs, then re-writing DDC is necessary.

The white-balance value for each common color temperature:

9300 parameter is  $x=283\pm 28$ ,  $y=297\pm 28$ ,  $Y = 180 \pm 10 \text{ cd/m}^2$ ,

6500 parameter is  $x = 313\pm 28$ ,  $y=329\pm 28$ ,  $Y = 180 \pm 10 \text{ cd/m}^2$ ,

5700 parameter is  $x = 328 \pm 28$ ,  $y = 344 \pm 28$ ,  $Y = 180 \pm 10 \text{ cd/m}^2$

The color temperature value above must be up to the situation of  $x < y$ . The value of Y should be confirmed according to different customers. 15" LCD is commonly  $180\pm 20 \text{ cd/cm}^2$  (Center) and 17" LCD is required to be larger than  $200 \text{ cd/cm}^2$  (Center). The exact brightness values are confirmed by the checking-regulations of different customers and different models.

### 2) Steps of white-balance adjustment for LCD:(Take 17" AOC LCD LM724 for example)

1. Required instruments: Chroma7120 \ Chroma2325 (BGA265A) .
2. First connect the instruments together and turn on the LCD power, then warm up for 30 minutes under full white screen mode. First press the "Reset" key in the menu to recover factory set as following.

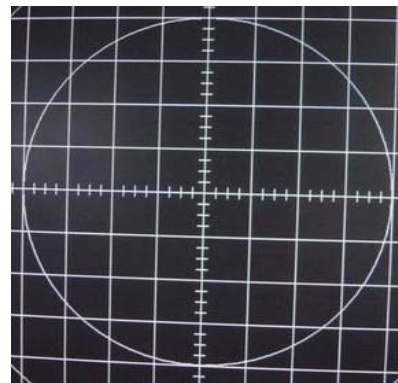
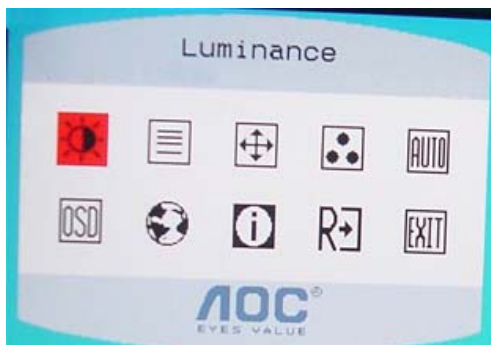

Set Chroma2325 at round-windows mode and make the detecting-head of Chroma7120 aim at the cross in the middle, the distance between the detecting-head and the cross is 20cm.

3. Set Chroma2325 (BGA265A) to be T144 (1280\*1024/60HZ) and P105 of full white screen. Test if the white-balance value is within the specs. Please follow the steps below to adjust if it is beyond the specs.
4. Cut the power. Then press MENU key and re-plug power cable at the same time to enter into the factory mode. See the following pictures.

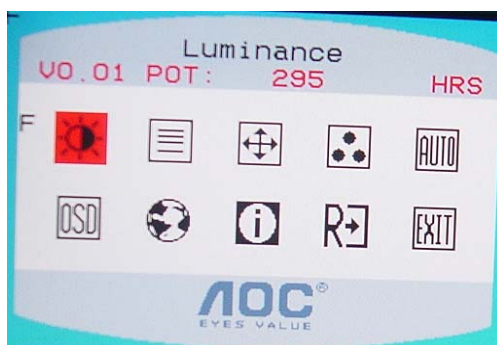

Select "F" ,then Select  
AUTO LEVEL item.



5. Test white-balance again after Auto Level. Adjustment with hand is necessary if it is beyond the specs.
6. Select 7x00 item to adjust cool color-temperature and select 6x00 to adjust warm color- temperature. It can reach to the best effect through adjusting R/G/B value if it inclines to green or blue.



7. Select Exit to the upper menu after completing the adjustment. Then press POWER OFF to exit and save it.

### 3) Steps for writing DDC :

1. Employ PC, and connect the DDC-writing instrument and the instrument that is ready for writing into DDC to the power of 12V. Connect the signal cable of the latter to D-USB or DVI of DDC-writing instrument (The data-writing of monitor needs transfer-interface) and link the DDC-writing instrument with PC through printer interface. (See the schematic picture below)



(Connection for VGA)



(Connection for DVI)

2. Seek the document with the expanded name of **.BAT** in DDC file of this model. It appears the indication of "Input Serial No. : " after dual-click the document to be ready for DDC-writing.
3. Input the serial number of the product (For instance: AOC LM725 is 13 bits), and then press ENTER to start writing
4. Check the indication of DDC-writing program at the end. When you see the picture as the schematic picture above, the "Data compare OK!" Means being written well and that's the end. Please check if the Manufacturer Name, Vendor Assigned Code, Monitor Name, Serial Number, Week of Manufacture, Year of Manufacture are right. It will appear "Data compare error!" To indicate failure if the DDC-writing doesn't perform well. Please check the power resource and the connection of the signal cable, then return to step 3 by pressing ENTER and re-do it.
5. You can exit the program by pressing Ctrl plus C, and then cut the signal cable and the power.
6. The following picture is taking AOC LM725 EDID for example.

```

Manufacturer Name : ADC
Product Code      : A725
Model Name       : LN725

Week of Manufacture : 22
Year of Manufacture : 2005
Video i/p definition : Analog
Checksum         : 6B
EEROM data table :
00 FF FF FF FF FF 00 05 E3 25 A7 01 00 00 00
16 0F 01 03 68 22 1B 78 2A 36 AD A2 59 4C 97 24
17 50 56 BF EF 00 81 80 01 01 01 01 01 01 01
01 01 01 01 01 01 BC 34 00 98 51 00 2A 40 10 90
13 00 54 0E 11 00 00 1E 00 00 00 FF 00 31 32 33
35 35 4A 41 30 30 30 30 30 31 00 00 00 FD 00 37
4B 1E 53 0E 00 0A 20 20 20 20 20 20 00 00 FC
00 4C 4D 37 32 35 0A 20 20 20 20 20 20 00 6B
data compare OK !

```

## Notes:

1. Make sure the system time of PC is in accordance with the real time before writing.
2. The schematic picture is just as an example for description; the exact content of the DDC is dependent on the serial number of the BARCORD of this model.
3. Data DDC-writing needs a transfer interface.

Instruction : DDC-writing needs 4 files:

1. Barcode.txt (Supply Barcode length and flow number)
2. \*.EXE (DDC-writing program)
3. WR.bat (Group order file for cycling utilization of \*.EXE, and dual-click this file when perform DDC-writing)
4. W.dat (The content with 128 bits of DDC)

## 14. BOM List

Part NO	Description	Quantity	Unit	Remark
CBPC780KCDDL	CONVERSION BOARD	1	PCS	For CPT panel
CBPC780KGDDL	CONVERSION BOARD	1	PCS	For LPL panel
PWPC1742CPD2P	POWER BOARD	1	PCS	For CPT panel
PWPC1742LGD2P	POWER BOARD	1	PCS	For LPL panel
15G6261 1	BRACKET	2	PCS	For CPT panel
15G6261 1	BRACKET	4	PCS	For LPL panel
15G8187 1	MAIN FRAME-CPT/LPL	1	PCS	For CPT/LPL panel
15G8187 4	MAIN FRAME	1	PCS	For LPL panel
750GLC70A07 5Z D	CPT 17" ZBD PANEL	1	PCS	For CPT panel
750GLG70E1T31Z D	LPL 17" TLB3 ZBD PANEL	1	PCS	For LPL (TLB3) panel
750GLG70E1T41Z D	LPL 17" TLB4 ZBD PANEL	1	PCS	For LPL (TLB4) panel

Location	Part NO	Description	Quantity	Unit
	Q1G6019 1	SCREW	1	PCS
	KEPC780KF2P	KEY BOARD	1	PCS
	11G6080 1	SPACER SUPPORT	1	PCS
	15G8146 1	KEVSINGTON BRACKET	1	PCS
	15G8185 1	HOLDER BRACKET R	1	PCS
	15G8186 1	HOLDER BRACKET L	1	PCS
	19G 588 1	SPRING HOLDER	2	PCS
	19G 589 1	SPRING BUTTON	1	PCS
	20G 027 2	STAND HOLDER	1	PCS
	23G3178700 3A	LOGO	1	PCS
	26G 800700 6A	S/N LABEL	1	PCS
	33G4884ASN L	BUTTON FUNC	1	PCS
	33G4885 Y2 L	BUTTON RELEASE	1	PCS
	34G1611AY2 B	BEZEL	1	PCS
	34G1612 Y2 B	REAR COVER	1	PCS
	40G 17N700 1A	ID LABEL	1	PCS
	40G 58162435A	LABEL	1	PCS
	40G 581700 3A6813	CARTON LABEL	1	PCS
	41G7800700 8A	E176 DAO PIG	1	PCS
	41G780070010A	QSG	1	PCS
	44G3586 3EPE	EPE	1	PCS
	44G3586BRO 2	PAPER BLOCK	1	PCS
	44G3770 1	EPS(L)	1	PCS
	44G3770 2	EPS(R)	1	PCS

	44G3770700 2A	CARTON	1	PCS
	44G3770BRO 1	PAPER BLOCK	1	PCS
	45G 88606 8	PE BAG FOR BASE	1	PCS
	45G 88607DE8	PE BAG	1	PCS
	52G 1186	SMALL TAPE	8	CM
	52G6020 2DE9	FILM PROTECT	1	PCS
	52G6022 1500	SMALL TAPE	12	CM
	52G6025 11848	MYLAR FOR POWER BOARD	1	PCS
	52G6025 11900	MYLAR FOR STAND HOLDER	2	PCS
	52G6025 11905	MYLAR	1	PCS
	52G6025 11923	MYLAR FOR SEFETY	1	PCS
	70G1700700 2A	CD MANUAL	1	PCS
	85G 702 1	SHIELD WIRE	1	PCS
	85G 703 1	SHIELD LAMP	1	PCS
	89G402A18NISD	POWER CORD	1	PCS
	95G8018 30 80	LVDS HARNESS	1	PCS
	M1G 130 4 47	SCREW	4	PCS
	M1G 330 4128	SCREW M3X4	1	PCS
	M1G1740 6128	SCREW	1	PCS
	M1G2940 10225	SCREW	4	PCS
	M1G3030 5125	SCREW	11	PCS
	Q1G6019 1	SCREW	3	PCS
	705G 780 87 D1	CN901 ASS'Y	1	PCS
	89G 728LAA 2	SIGNAL CABLE	1	PCS
	AIC780KCDDLDP	MAIN BOARD	1	PCS
	40G 457624 1B	LABEL-CPU	1	PCS
	40G 45762412B	CBPC LABEL	1	PCS
C101	67G309V220 3	22UF +-20% 16V	1	PCS
C401	67G309V220 3	22UF +-20% 16V	1	PCS
C409	67G309V220 3	22UF +-20% 16V	1	PCS
C416	67G309V220 3	22UF +-20% 16V	1	PCS
C419	67G309V220 3	22UF +-20% 16V	1	PCS
C425	67G309V220 3	22UF +-20% 16V	1	PCS
C701	67G309V220 3	22UF +-20% 16V	1	PCS
C710	67G309V220 3	22UF +-20% 16V	1	PCS
C711	67G309V220 3	22UF +-20% 16V	1	PCS
C717	67G309V220 3	22UF +-20% 16V	1	PCS
CN101	33G8043 24 H	CONNECTER	1	PCS
CN403	33G8019 8C H	CONNEETER	1	PCS

CN405	88G 35315F H	D-SUB 15PIN	1	PCS
CN701	33G8027 12	WAFER 2*6P 2.0MM R/A	1	PCS
X401	93G 22 53	CRYSTAL 14.318MHzHC-49U	1	PCS
	715G1565 1	MAIN BOARD	1	PCS
C102	65G0603104 12	CER2 0603 X7R 16V 100N	1	PCS
C402	65G0603104 12	CER2 0603 X7R 16V 100N	1	PCS
C403	65G0603104 12	CER2 0603 X7R 16V 100N	1	PCS
C404	65G0603104 12	CER2 0603 X7R 16V 100N	1	PCS
C405	65G0603104 12	CER2 0603 X7R 16V 100N	1	PCS
C406	65G0603104 12	CER2 0603 X7R 16V 100N	1	PCS
C407	65G0603104 12	CER2 0603 X7R 16V 100N	1	PCS
C410	65G0603104 12	CER2 0603 X7R 16V 100N	1	PCS
C411	65G0603104 12	CER2 0603 X7R 16V 100N	1	PCS
C412	65G0603104 12	CER2 0603 X7R 16V 100N	1	PCS
C413	65G0603104 12	CER2 0603 X7R 16V 100N	1	PCS
C414	65G0603104 12	CER2 0603 X7R 16V 100N	1	PCS
C417	65G0603104 12	CER2 0603 X7R 16V 100N	1	PCS
C418	65G0603104 12	CER2 0603 X7R 16V 100N	1	PCS
C420	65G0603104 12	CER2 0603 X7R 16V 100N	1	PCS
C421	65G0603104 12	CER2 0603 X7R 16V 100N	1	PCS
C422	65G0603104 12	CER2 0603 X7R 16V 100N	1	PCS
C423	65G0603104 12	CER2 0603 X7R 16V 100N	1	PCS
C424	65G0603104 12	CER2 0603 X7R 16V 100N	1	PCS
C426	65G0603104 12	CER2 0603 X7R 16V 100N	1	PCS
C427	65G0603330 31	CER1 0603 NP0 50V 33P P	1	PCS
C428	65G0603330 31	CER1 0603 NP0 50V 33P P	1	PCS
C430	65G0603104 12	CER2 0603 X7R 16V 100N	1	PCS
C431	65G0603104 12	CER2 0603 X7R 16V 100N	1	PCS
C432	65G0603473 32	CHIP 0.047UF 50V X7R	1	PCS
C433	65G0603473 32	CHIP 0.047UF 50V X7R	1	PCS
C434	65G0603473 32	CHIP 0.047UF 50V X7R	1	PCS
C435	65G0603224 17	CAP:CER 0.22UF-20%-80%	1	PCS
C436	65G0603473 32	CHIP 0.047UF 50V X7R	1	PCS
C437	65G0603473 32	CHIP 0.047UF 50V X7R	1	PCS
C438	65G0603473 32	CHIP 0.047UF 50V X7R	1	PCS
C439	65G0603104 12	CER2 0603 X7R 16V 100N	1	PCS
C441	65G0603104 12	CER2 0603 X7R 16V 100N	1	PCS
C442	65G0603220 31	CER1 0603 NP0 50V 22P P	1	PCS
C443	65G0603220 31	CER1 0603 NP0 50V 22P P	1	PCS

C444	65G0603104 12	CER2 0603 X7R 16V 100N	1	PCS
C445	65G0603104 12	CER2 0603 X7R 16V 100N	1	PCS
C446	65G0603104 12	CER2 0603 X7R 16V 100N	1	PCS
C454	65G0603104 32	CHIP 0.1UF 50V X7R	1	PCS
C455	65G0603104 32	CHIP 0.1UF 50V X7R	1	PCS
C456	65G0603104 32	CHIP 0.1UF 50V X7R	1	PCS
C457	65G0603104 32	CHIP 0.1UF 50V X7R	1	PCS
C458	65G0603104 12	CER2 0603 X7R 16V 100N	1	PCS
C703	65G0603104 12	CER2 0603 X7R 16V 100N	1	PCS
C704	65G0603104 12	CER2 0603 X7R 16V 100N	1	PCS
C707	65G0603104 12	CER2 0603 X7R 16V 100N	1	PCS
C708	65G0603104 12	CER2 0603 X7R 16V 100N	1	PCS
C712	65G0603104 12	CER2 0603 X7R 16V 100N	1	PCS
C713	65G0603104 12	CER2 0603 X7R 16V 100N	1	PCS
C715	65G0603104 12	CER2 0603 X7R 16V 100N	1	PCS
C718	65G0603104 12	CER2 0603 X7R 16V 100N	1	PCS
D403	93G 6433P	BAV99	1	PCS
D404	93G 6433P	BAV99	1	PCS
D405	93G 6433P	BAV99	1	PCS
D406	93G 39146	LL5232B	1	PCS
D407	93G 64 42 P	BAV70 SOT-23	1	PCS
D408	93G 39146	LL5232B	1	PCS
D409	93G 39146	LL5232B	1	PCS
D410	93G 39146	LL5232B	1	PCS
D411	93G 39146	LL5232B	1	PCS
D412	93G 39146	LL5232B	1	PCS
D704	93G2004 2	SR24/PANJIT-SMT	1	PCS
FB401	71G 56K121 M	CHIP BEAD	1	PCS
FB402	71G 56K121 M	CHIP BEAD	1	PCS
FB403	71G 56K121 M	CHIP BEAD	1	PCS
FB404	71G 56K121 M	CHIP BEAD	1	PCS
FB405	71G 56K121 M	CHIP BEAD	1	PCS
FB406	71G 56K121 M	CHIP BEAD	1	PCS
FB410	71G 59C600 GP	CHIP BEAD 50 OHM 1608 F	1	PCS
FB411	71G 59C600 GP	CHIP BEAD 50 OHM 1608 F	1	PCS
FB412	71G 59C600 GP	CHIP BEAD 50 OHM 1608 F	1	PCS
FB702	71G 56K121 M	CHIP BEAD	1	PCS
Q401	57G 417 4	PMBS3904/PHILIPS-SMT(04	1	PCS
Q403	57G 417 4	PMBS3904/PHILIPS-SMT(04	1	PCS

Q703	57G 417 4	PMBS3904/PHILIPS-SMT(04	1	PCS
Q704	57G 763 1A	AP2305N	1	PCS
Q706	57G 417 4	PMBS3904/PHILIPS-SMT(04	1	PCS
R101	61L0603472	RST SM 0603 RC0603 4K7	1	PCS
R402	61L0603249 0F	CHIP 249OHM 1/16W 1%	1	PCS
R406	61L0603472	RST SM 0603 RC0603 4K7	1	PCS
R407	61L0603472	RST SM 0603 RC0603 4K7	1	PCS
R408	61L0603472	RST SM 0603 RC0603 4K7	1	PCS
R409	61L0603101	RST SM 0603 RC0603 100R	1	PCS
R410	61L0603101	RST SM 0603 RC0603 100R	1	PCS
R411	61L0603101	RST SM 0603 RC0603 100R	1	PCS
R416	61L0603472	RST SM 0603 RC0603 4K7	1	PCS
R417	61L0603472	RST SM 0603 RC0603 4K7	1	PCS
R419	61L0603000	RST SM 0603 JUMP MAX 0R	1	PCS
R421	61L0603562	CHIP 5.6K OHM 1/10W	1	PCS
R422	61L0603103	RST SM 0603 RC0603 10K	1	PCS
R423	61L0603472	RST SM 0603 RC0603 4K7	1	PCS
R424	61L0603472	RST SM 0603 RC0603 4K7	1	PCS
R425	61L0603472	RST SM 0603 RC0603 4K7	1	PCS
R426	61L0603103	RST SM 0603 RC0603 10K	1	PCS
R427	61L0603472	RST SM 0603 RC0603 4K7	1	PCS
R429	61L0603103	RST SM 0603 RC0603 10K	1	PCS
R432	61L0603472	RST SM 0603 RC0603 4K7	1	PCS
R434	61L0603750	RST SM 0603 RC22H 75R P	1	PCS
R435	61L0603750	RST SM 0603 RC22H 75R P	1	PCS
R436	61L0603750	RST SM 0603 RC22H 75R P	1	PCS
R438	61L0603750 9F	75OHM 1% 1/10W	1	PCS
R439	61L0603750 9F	75OHM 1% 1/10W	1	PCS
R440	61L0603750 9F	75OHM 1% 1/10W	1	PCS
R441	61L0603101	RST SM 0603 RC0603 100R	1	PCS
R442	61L0603101	RST SM 0603 RC0603 100R	1	PCS
R443	61L0603101	RST SM 0603 RC0603 100R	1	PCS
R444	61L0603103	RST SM 0603 RC0603 10K	1	PCS
R445	61L0603221	RST SM 0603 RC0603 220R	1	PCS
R446	61L0603221	RST SM 0603 RC0603 220R	1	PCS
R447	61L0603221	RST SM 0603 RC0603 220R	1	PCS
R448	61L0603222	RST SM 0603 RC0603 2K2	1	PCS
R449	61L0603222	RST SM 0603 RC0603 2K2	1	PCS
R450	61L0603472	RST SM 0603 RC0603 4K7	1	PCS

R451	61L0603472	RST SM 0603 RC0603 4K7	1	PCS
R452	61L0603472	RST SM 0603 RC0603 4K7	1	PCS
R453	61L0603221	RST SM 0603 RC0603 220R	1	PCS
R454	61L0603221	RST SM 0603 RC0603 220R	1	PCS
R455	61L0603221	RST SM 0603 RC0603 220R	1	PCS
R457	61L0603101	RST SM 0603 RC0603 100R	1	PCS
R458	61L0603101	RST SM 0603 RC0603 100R	1	PCS
R459	61L0603473	RST SM 0603 RC0603 47K	1	PCS
R460	61L0603473	RST SM 0603 RC0603 47K	1	PCS
R461	61L0603221	RST SM 0603 RC0603 220R	1	PCS
R462	61L0603221	RST SM 0603 RC0603 220R	1	PCS
R463	61L0603221	RST SM 0603 RC0603 220R	1	PCS
R464	61L0603221	RST SM 0603 RC0603 220R	1	PCS
R465	61L0603221	RST SM 0603 RC0603 220R	1	PCS
R466	61L0603103	RST SM 0603 RC0603 10K	1	PCS
R467	61L0603103	RST SM 0603 RC0603 10K	1	PCS
R468	61L0603103	RST SM 0603 RC0603 10K	1	PCS
R469	61L0603303	CHIP 30K OHM 5% 1/10W	1	PCS
R470	61L0603223	CHIPR 22K OHM +-5% 1/10	1	PCS
R471	61L0603223	CHIPR 22K OHM +-5% 1/10	1	PCS
R472	61L0603303	CHIP 30K OHM 5% 1/10W	1	PCS
R474	61L0603472	RST SM 0603 RC0603 4K7	1	PCS
R477	61L0603472	RST SM 0603 RC0603 4K7	1	PCS
R705	61L0603472	RST SM 0603 RC0603 4K7	1	PCS
R707	61L0603102	RST SM 0603 RC0603 1K P	1	PCS
R708	61L0603102	RST SM 0603 RC0603 1K P	1	PCS
R710	61L0603102	RST SM 0603 RC0603 1K P	1	PCS
R714	61L0603473	RST SM 0603 RC0603 47K	1	PCS
R721	61L0603000	RST SM 0603 JUMP MAX 0R	1	PCS
R723	61L0603473	RST SM 0603 RC0603 47K	1	PCS
R725	61L0603473	RST SM 0603 RC0603 47K	1	PCS
U401	56G 562101	GM2621-LF-BC	1	PCS
U402	56G1133 59CD2	SST25VF010-20-4C-SAE SO	1	PCS
U404	56G1133 34	M24C02-WMN6TP	1	PCS
U701	56G 585 4	AIC1117-33CY	1	PCS
U702	56G 563 27	AIC1117A-18CY SOT-223	1	PCS
	AIK780KF2SMTP	KEY BOARD	1	PCS
	715G1564 1	PCB	1	PCS
C01	65G0603104 12	CER2 0603 X7R 16V 100N	1	PCS



C02	65G0603104 12	CER2 0603 X7R 16V 100N	1	PCS
CN1	89G176S 8 4	FFC CABLE	1	PCS
LED01	81G 14501 KT	CHIP LED	1	PCS
SW01	77G 605 1 AL GP	SMD SWITCH	1	PCS
SW02	77G 605 1 AL GP	SMD SWITCH	1	PCS
SW03	77G 605 1 AL GP	SMD SWITCH	1	PCS
SW04	77G 605 1 AL GP	SMD SWITCH	1	PCS
ZD01	93G 39S 34 T	UDZS5.6B	1	PCS
ZD02	93G 39S 34 T	UDZS5.6B	1	PCS
ZD03	93G 39S 34 T	UDZS5.6B	1	PCS
ZD04	93G 39S 34 T	UDZS5.6B	1	PCS
ZD05	93G 39S 34 T	UDZS5.6B	1	PCS
ZD06	93G 39S 34 T	UDZS5.6B	1	PCS
	PW1742CPD2SMTP	POWER BOARD	1	PCS
	40G 45762420A	ID LABEL	1	PCS
	52G6025 11935	MYLAR FOR PANEL	1	PCS
	705G 780 57 D1	Q901 ASS'Y	1	PCS
	705G 780 57 D2	Q203 ASS'Y	1	PCS
	705G 780 93 D1	D921/D922 ASS'Y	1	PCS
C203	67G215L471 4N	KY25VB470M-L10*16	1	PCS
C211	65L 3J1806ET	18PF 5% 3KV TDK	1	PCS
C212	65L 3J1506ET	15PF 3KV 5%	1	PCS
C213	65L 3J1506ET	15PF 3KV 5%	1	PCS
C214	65L 3J1806ET	18PF 5% 3KV TDK	1	PCS
C221	63G211J334 AB	0.33UF 5% 160V R75 BY A	1	PCS
C900	65G306M4722BP	4700PF +-20% 400VAC	1	PCS
C901	65G305M2222BP	2200PF +-20%	1	PCS
C902	65G305M2222BP	2200PF +-20%	1	PCS
C903	63G 107474 HS	0.47UF +-20% 275VAC	1	PCS
C904	67G215S10115K	100UF 450V	1	PCS
C923	67G215L102 4R	LOW E.S.R 1000UF +/-20%	1	PCS
C924	67G215L102 4R	LOW E.S.R 1000UF +/-20%	1	PCS
C925	67G215L471 4N	KY25VB470M-L10*16	1	PCS
C926	67G215Y4713NV	KY16VB470M-CC3 8*15MM	1	PCS
C931	67G215L102 4R	LOW E.S.R 1000UF +/-20%	1	PCS
CN201	33G8021 2D AC	CONN.2P R/A 87210-0236	1	PCS
CN202	33G8021 2D AC	CONN.2P R/A 87210-0236	1	PCS
CN203	33G8021 2D AC	CONN.2P R/A 87210-0236	1	PCS
CN204	33G8021 2D AC	CONN.2P R/A 87210-0236	1	PCS

CN901	33G8029 3A H	B2P3S-VH	1	PCS
CN902	95G8014 12523	WIRE	1	PCS
D901	93G 6026W52T	FR107	1	PCS
DB901	93G 50460502	KBP206G	1	PCS
IC902	56G 139 3A	PC123Y22FZOF	1	PCS
L201	73G 253515 L	CHOKO COIL	1	PCS
L901	73L 174 50 LH	LINE FILTER	1	PCS
L902	73G 174 65 LS	LINE FILTER BY LISHIN	1	PCS
L903	73G 253 91 H	CHOKO COIL	1	PCS
L904	73G 253 91 H	CHOKO COIL	1	PCS
NR901	61G 58080 WT	8 OHM NCT	1	PCS
PT201	80GL17T 28 YS	X'FMR YSTDA500101G	1	PCS
PT202	80GL17T 28 YS	X'FMR YSTDA500101G	1	PCS
Q206	57G 761 7	KTD1691P	1	PCS
Q207	57G 761 7	KTD1691P	1	PCS
R908	61G152M10458G6267	100K OHM 5% 2W	1	PCS
R918	61G152M398 64	0.39 OHM 2W	1	PCS
T901	80GL17T 29 LS	ADAPTOR BY LISHIN	1	PCS
	PW1742CPD2AIP	POWER BOARD	1	PCS
C201	65G0805104 22	0.1UF +-10% 25V X7R 080	1	PCS
C202	65G0805104 22	0.1UF +-10% 25V X7R 080	1	PCS
C204	65G0805104 22	0.1UF +-10% 25V X7R 080	1	PCS
C205	65G0805105 22 GP	CHIP 1UF 25V X7R 0805	1	PCS
C207	65G0805331 32	CHIP 330P 50V X7R 0805	1	PCS
C208	65G0805104 22	0.1UF +-10% 25V X7R 080	1	PCS
C210	65G0805105 22 GP	CHIP 1UF 25V X7R 0805	1	PCS
C222	65G0805474 22	CHIP 0.47UF 25V X7R 080	1	PCS
C223	65G0805105 22	CHIP 1UF 25V X7R 0805	1	PCS
C907	65G0805104 32	CHIP 0.1U 50V X7R	1	PCS
C911	65G0805471 31	CHIP 470PF 50V NPO	1	PCS
C912	65G0805102 32	CHIP 1000P 50VX7R 0805	1	PCS
C927	65G0805104 32	CHIP 0.1U 50V X7R	1	PCS
C928	65G0805104 32	CHIP 0.1U 50V X7R	1	PCS
C929	65G0805104 32	CHIP 0.1U 50V X7R	1	PCS
C932	65G0805474 22	CHIP 0.47UF 25V X7R 080	1	PCS
D201	93G 60264	B340A	1	PCS
D210	93G 6432P	LL4148	1	PCS
D903	93G 6432P	LL4148	1	PCS
D923	93G 6432P	LL4148	1	PCS

D924	93G 6432P	LL4148	1	PCS
F902	61L1206000	RST SM 1206 JUMP MAX 0R	1	PCS
IC201	56G 608 1	TL1451ACD	1	PCS
IC901	56G 379 54	NCP1203D60R2G BY ON	1	PCS
Q201	57G 760 5	DTC144WKA BY ROHM SMT	1	PCS
Q202	57G 760 4	DTA144WKA BY ROHM SMT	1	PCS
Q204	57G 417 4	PMBS3904/PHILIPS-SMT(04	1	PCS
Q205	57G 417 6	PMBS3906/PHILIPS-SMT(06	1	PCS
R201	61L0805240 1F	CHIPR 2.4KOHM +-1% 1/8W	1	PCS
R202	61L0805221	CHIPR 220 OHM +-5% 1/8W	1	PCS
R203	61L0805240 1F	CHIPR 2.4KOHM +-1% 1/8W	1	PCS
R204	61L0805471	CHIPR 470 OHM+-5% 1/8W	1	PCS
R205	61L0805163	CHIP 16KOHM 1/10W	1	PCS
R206	61L0805123	CHIP 12KOHM 1/8W	1	PCS
R207	61L0805103	CHIPR 10K OHM +-5% 1/8W	1	PCS
R208	61L0805000	CHIP O OHM 1/8W	1	PCS
R209	61L0805000	CHIP O OHM 1/8W	1	PCS
R210	61L0805473	CHIPR 47K OHM +-5% 1/8W	1	PCS
R212	61L0805623	CHIPR 62K OHM +-5% 1/8W	1	PCS
R213	61L0805472	CHIPR 4.7K OHM +-5% 1/8	1	PCS
R214	61L0805123	CHIP 12KOHM 1/8W	1	PCS
R229	61L0805681	680 OHM 1/10W	1	PCS
R230	61L0805471	CHIPR 470 OHM+-5% 1/8W	1	PCS
R231	61L0805123	CHIP 12KOHM 1/8W	1	PCS
R232	61L0805510 2F	CHIP 51K OHM 1/10W	1	PCS
R900	61L1206334	330K 1/4W	1	PCS
R901	61L1206334	330K 1/4W	1	PCS
R902	61L1206334	330K 1/4W	1	PCS
R903	61L1206332	CHIP 3.3K OHM 5% 1/8W	1	PCS
R904	61L1206332	CHIP 3.3K OHM 5% 1/8W	1	PCS
R905	61L1206332	CHIP 3.3K OHM 5% 1/8W	1	PCS
R909	61L0805220	CHIP 22 OHM 5% 0805 1/8	1	PCS
R910	61L0805222	CHIP 2.2KOHM 5% 0805 1/	1	PCS
R911	61L0805362	CHIP 306KOHM 1/8W	1	PCS
R912	61L0805101	CHIPR 100 OHM +-5% 1/8W	1	PCS
R913	61L0805753	75K 1/8W	1	PCS
R914	61L0805472	CHIPR 4.7K OHM +-5% 1/8	1	PCS
R915	61L0805220	CHIP 22 OHM 5% 0805 1/8	1	PCS
R916	61L0805221	CHIPR 220 OHM +-5% 1/8W	1	PCS

R917	61L0805103	CHIPR 10K OHM +-5% 1/8W	1	PCS
R919	61L0805203	CHIPR 20KOHM +-5% 1/8W	1	PCS
R924	61L0805102	CHIPR 1K OHM +-5% 1/8W	1	PCS
R925	61L1206000	RST SM 1206 JUMP MAX 0R	1	PCS
R929	61L0805330 2F	CHIP 33KOHM 1/8W 1%	1	PCS
R930	61L0805360 1F	CHIP 3.6KOHM 1/8W 1%	1	PCS
R931	61L0805102	CHIPR 1K OHM +-5% 1/8W	1	PCS
R932	61L0805102	CHIPR 1K OHM +-5% 1/8W	1	PCS
R933	61L0805240 1F	CHIPR 2.4KOHM +-1% 1/8W	1	PCS
ZD201	93G 39S 8 T	RLZ11B LLDS	1	PCS
ZD901	93G 39S 44 T	RLZ18B LLDS	1	PCS
ZD902	93G 39S 25 T	RLZ5.1B LLDS	1	PCS
ZD903	93G 39S 38 T	PTZ 9.1B	1	PCS
ZD904	93G 39S 40 T	RLZ 13B LLDS	1	PCS
ZD905	93G 39S 25 T	RLZ5.1B LLDS	1	PCS
	715G1492 1 FR	PCB	1	PCS
C209	67G 305330 7T	33UF 105	1	PCS
C904	6G 31502	1.5MM RIVET	2	PCS
C905	65G 2K152 1T6921	1.5NF/2KV Y5P +-10%	1	PCS
C906	67G 2151014KT	100UF	1	PCS
C909	67G 3054704KT	47UF	1	PCS
C921	65G517K102 5T	1000PF 10% Y5P 500V	1	PCS
C922	65G517K102 5T	1000PF 10% Y5P 500V	1	PCS
CN901	6G 31500	EYELET	2	PCS
D202	93G 64 1152T	1N4148	1	PCS
D203	93G 64 1152T	1N4148	1	PCS
D204	93G 64 1152T	1N4148	1	PCS
D205	93G 64 1152T	1N4148	1	PCS
D206	93G 64 1152T	1N4148	1	PCS
D207	93G 64 1152T	1N4148	1	PCS
D208	93G 64 1152T	1N4148	1	PCS
D209	93G 64 1152T	1N4148	1	PCS
D902	93G1020 752T	UF4003	1	PCS
F901	84G 56 1	FUSE 2A 250V WICKMANN	1	PCS
IC903	56G 158 12	KIA431A-AT/P TO-92	1	PCS
J914	71G 55 9 T	FERRITE BEAD	1	PCS
L902	6G 31502	1.5MM RIVET	4	PCS
Q901	6G 31502	1.5MM RIVET	1	PCS
Q902	57G 420 PP T	2PA733P	1	PCS

Q903	57G 419 PP T	2PC945P	1	PCS
R221	61G 17218252T	1.8KOHM 5% 1/4W	1	PCS
R222	61G 17218252T	1.8KOHM 5% 1/4W	1	PCS
R223	61G 17218252T	1.8KOHM 5% 1/4W	1	PCS
R224	61G 17218252T	1.8KOHM 5% 1/4W	1	PCS
R225	61G 17210252T	1K OHM 5% 1/4W	1	PCS
R226	61G 17210252T	1K OHM 5% 1/4W	1	PCS
R227	61G 17210252T	1K OHM 5% 1/4W	1	PCS
R228	61G 17210252T	1K OHM 5% 1/4W	1	PCS
R921	61G175L47052T	47OHM +-5% 1/2W	1	PCS
R922	61G175L47052T	47OHM +-5% 1/2W	1	PCS
R923	61G 17256152T	560 OHM 5% 1/4W	1	PCS
T901	6G 31502	1.5MM RIVET	4	PCS
	90G6240 1	HEAT SINK	1	PCS
	M1G1730 8128	SCREW M3x8	1	PCS
Q901	57G 749 1C	2SK3264	1	PCS
	15G6284 1	PLATE	1	PCS
	90G 411501	HEAT SINK	1	PCS
	M1G 330 4128	SCREW M3X4	1	PCS
Q203	57G 763 12	AOU401 BY AOS	1	PCS
	90G6240 2	HEAT SINK	1	PCS
	M1G1730 8128	SCREW M3x8	2	PCS
D921	93G 60239	FME-210B T0-220	1	PCS
D922	93G1506 2	FMW-2156	1	PCS
	87G 501 14 RF	AC SOCKET	1	PCS
	95G 900595	WIRE	1	PCS
	95G8021 3 11	HARNESS	1	PCS
	96G 29 6	SHRINK TUBE UL/CSA	3	PCS
	12G6097 1	PORON	6	PCS
	15G8188 1	BASE BKT	1	PCS
	15G8190 1	VESA-PLATE	1	PCS
	20G 030 1	STAND DIE CAST	1	PCS
	34G1614 Y2 B	VESA COVER	1	PCS
	34G1615 SN B	RISER FRONT	1	PCS
	34G1616 Y2 B	RISER BACK	1	PCS
	34G1617AST B	BASE	1	PCS
	37G 535 2	HINGE ASS'Y(17")	1	PCS
	M1G 130 6125	SCREW	4	PCS
	M1G 130 8120	SCREW	3	PCS

	M1G 140 8225	SCREW M3X8	2	PCS
	Q1G 130 8 47	SCREW	4	PCS

### 14. Definition Of Pixel Defects

#### 14.1 CLAA170EA 07

DEFECT TYPE		LIMIT		Note	
<b>VISUAL DEFECT</b>	SCRATCH		$0.01\text{mm} \leq W \leq 0.05\text{mm}$ $L \leq 10\text{mm}$	$N \leq 4$	-
	INTERNAL	SPOT	$0.15\text{mm} \leq \varphi \leq 0.5\text{mm}$	$N \leq 4$	Note1
		FIBER	$W \leq 1.0\text{mm}, L \leq 3 \text{ mm}$	$N \leq 4$	Note1
		POLARIZER BUBBLE	$0.15\text{mm} \leq \varphi \leq 0.5\text{mm}$	$N \leq 4$	Note1
		TOTAL	$N \leq 8$		-
<b>ELECTRICAL DEFECT</b>	BRIGHT DOT		$N \leq 0(\text{FLASH DOT } N \leq 0)$		Note2
	DARK DOT		$N \leq 4$		-
	TOTAL DOT		$N \leq 5$		Note2
	TWO ADJACENT DOT		$\leq 2 \text{ PAIRS}$		Note3
	THREE OR MORE ADJACENT DOT		NOT ALLOWED		-
	DISTANCE BETWEEN DEFECT DOT		Two dark dots $\geq 10\text{mm}$		Note4
	LINE DEFECT		NOT ALLOWED		-

One pixel consists of 3 sub-pixels, including R,G, and B dot.(Sub-pixel = Dot)

[Note1] W : Width[mm], L : Length[mm], N : Number,  $\varphi$  : Average Diameter

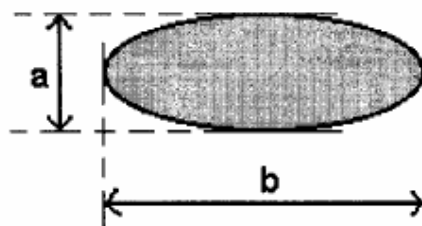

$$\varphi = (a + b) / 2$$

1. (White, black) Spot
2. Polarizer Bubble



1. Fiber

[Note2] Bright dot is defined through 5% transmission ND Filter as following.

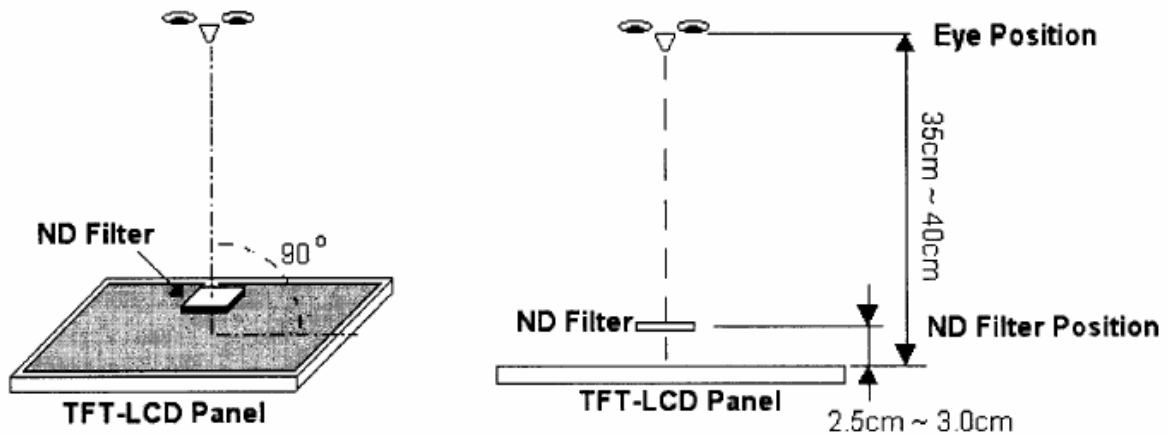

[Note3] Judge defect dot and adjacent dot as following. Allow below (as A, B, C and D status) adjacent defect dots, including bright and dart adjacent dot. And they will be counted 2 defect dots in total quantity.

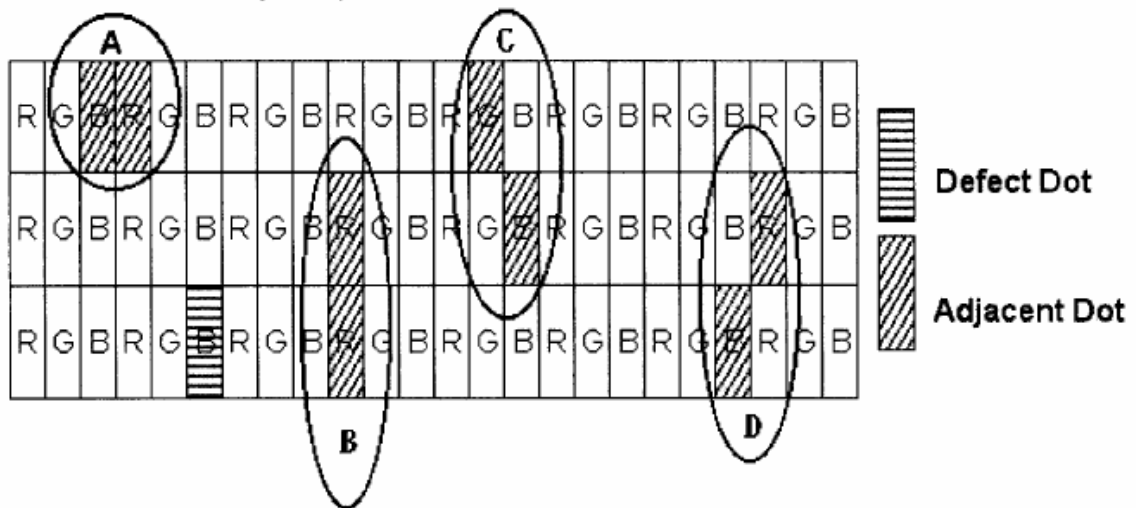

[Note4] Definition of distance between defect dot as following.

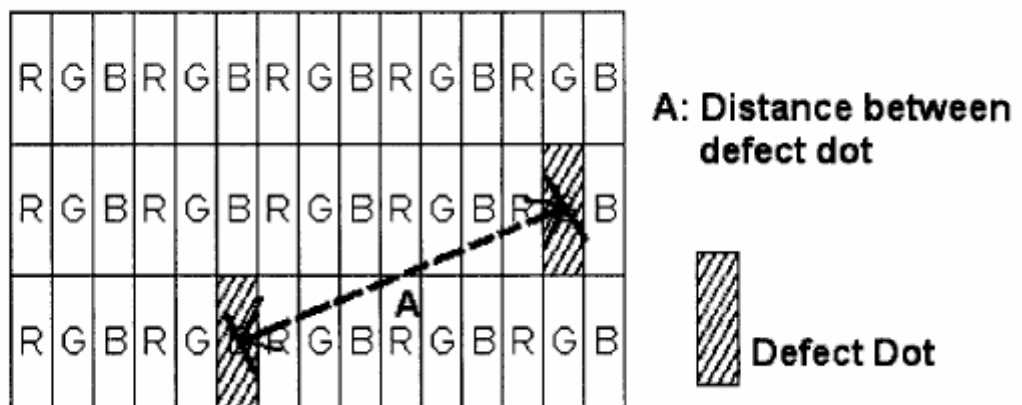

[Note5] Other

- (1) The defects that are not defined above and considered to be problem shall be reviewed and discussed by both parties.
- (2) Defects on the Black Matrix, out of Display area, are not considered as a defect or counted.

**14.2 LM170E01-TLB3 / LM170E01-TLB4**

**14.2.1 Dot Defect**

**14.2.1.1 Bright Dot**

Dots (sub-pixels) which appeared brightly in the screen when the LCM displayed with dark pattern.

- R, G or B 1 dot ----- 0 Max
- Adjacent 2 dots ----- 0 Max
- Total amount of Bright dots ----- 0 Max
- Minimum distance of Bright dots ----- NA

**14.2.1.2 Dark Dot**

Dots (sub-pixels) which appeared darkly in the screen when the LCM displayed with bright pattern.

- 1 dot ----- 4 Max
- Adjacent 2 dots ----- 2 Max
- Total amount of Dark dot ----- 4 Max
- Minimum distance of Dark dots ----- 15mm

**14.2.1.3 Total amount of Dot Defects ----- 5 Max (Combination)**

Note) a. Every dot herein means Sub-Pixel (Each Red, Green, or Blue Color)

b. Bright dot

- Red or Blue dots smaller than half size of sub-pixel are not counted as a defect dots.
- Green dots smaller than 1 / 3 size of sub-pixel are not counted as a defect dots.

c. Dark dots smaller than half size of sub-pixel are not counted as a defect dots.

**14.2.2. Polarizer Defects**

Items		Criteria
Scratches	Linear	$0.01 \leq W \leq 0.1, 0.3 \leq L \leq 10, N \leq 4$
Dent	Circular	$0.15 \leq D \leq 0.5, N \leq 3$

Where, W: Width

L: Length

D: Average diameter  $= (a+b)/2$

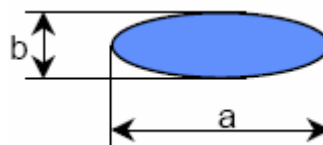

- a. Extraneous substances, which can be wiped out, like Finger Print, Particles, are not considered as a defect.
- b. Defects which are on the Black Matrix (outside of Active Area) are not considered as a defect.

**14.2.3 Foreign Material**

Items	Criteria
Linear	$0.05 \leq W \leq 0.1, 0.3 \leq L \leq 4.0, N \leq 4$
Circular	$0.15 \leq D \leq 0.5, N \leq 4$



Where, W: Width

L: Length

D: Average diameter  $=(a+b)/2$

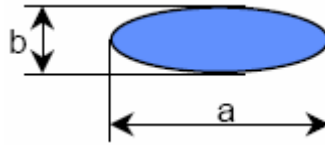

#### **14.2.4 Line Defect**

All kinds of line defects such as vertical, horizontal or cross are not allowed.

#### **14.2.5 Bezel Appearance**

Scratches, minor dents, stain, particles on the Bezel frame are not considered as a defect.

#### **14.2.6 others**

Issues, which are not defined in these criteria, shall be discussed with both parties, Customer and Supplier, for better solution.