

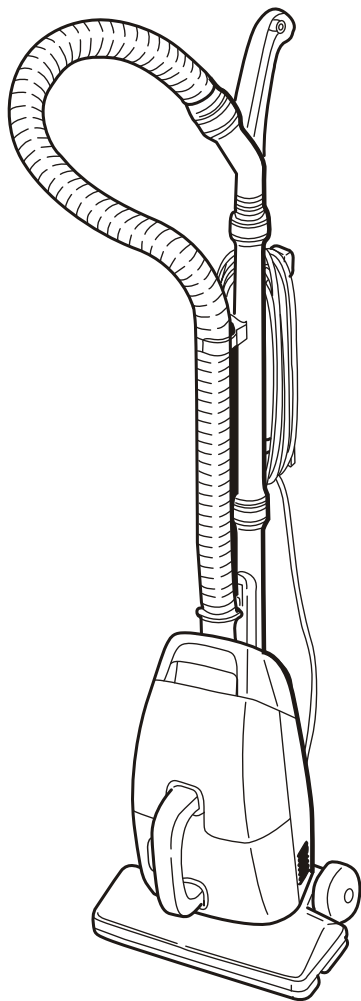

INSTRUCTION MANUAL

SC-150
SC-180

VACUUM CLEANER



Contents

IMPORTANT SAFETY INSTRUCTIONS	1,2
FEATURES.....	3
NAMES OF PARTS.....	4
ASSEMBLING THE VACUUM CLEANER	5
USING THE VACUUM CLEANER	6,7
REPLACING THE PAPER BAG.....	8
PRODUCT MAINTENANCE	9
TROUBLESHOOTING	10
REPLACEMENT PARTS.....	10

IMPORTANT SAFETY INSTRUCTIONS

When using an electrical appliance, basic precautions should always be followed, including the following.

READ ALL INSTRUCTIONS BEFORE USING THIS VACUUM CLEANER

WARNING - To reduce the risk of fire, electric shock or injury:

- Do not leave appliance when plugged in. Unplug from outlet when not in use and before servicing.
- Do not use outdoors or on wet surfaces.
- Do not allow to be used as a toy. Close attention is necessary when used by or near children.
- Use only as described in this manual. Use only the manufacturer's recommended attachments.
- Do not use with a damaged cord or plug. If appliance is not working as it should, has been dropped, damaged, left outdoors, or dropped into water, return it to a service center.
- Do not pull or carry by the cord, use cord as a handle, close a door on cord, or pull cord around sharp edges or corners. Do not run appliance over cord. Keep cleaner over the cord. Keep the cord away from heated surfaces.
- Do not unplug by pulling on cord. To unplug, grasp the plug, not the cord.
- Do not handle plug or appliance with wet hands.
- Do not put any object into the openings. Do not use with any opening blocked; keep free of dust, lint, hair and anything that may reduce air flow.
- Keep hair, loose clothing, fingers and all parts of body away from openings and moving parts.
- Do not pick up anything that is burning or smoking, such as cigarettes, matches or hot ashes.
- Do not use without filters in place.
- Turn off all controls before unplugging.
- Use extra care when cleaning on stairs.
- Do not use to pick up flammable or combustible liquids such as gasoline, or use in areas where they may be present.
- Unplug before connecting any hose attachment accessory.

- Do not touch the agitator while it is spinning.
- To reduce the risk of electric shock, this appliance has a polarized plug (one blade is wider than the other). This plug will fit in a polarized outlet only one way. If the plug does not fit fully in the outlet, reverse the plug. If it still does not fit, contact a qualified electrician to install the proper outlet. Do not change the plug in any way.

SAVE THESE INSTRUCTIONS

This vacuum cleaner is intended for household use only.

FEATURES

CLEANS CARPETS AND OTHER FLOORING



CLEANING IN NARROW SPACES AND HARD-TO-REACH PLACES, SUCH AS UNDER BEDS, ETC.

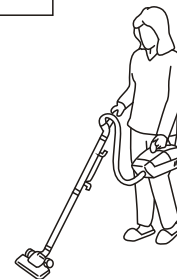

TABLETOP CLEANING AND CLEANING OF SLIDING WINDOW OR DOOR GROOVES, ETC.

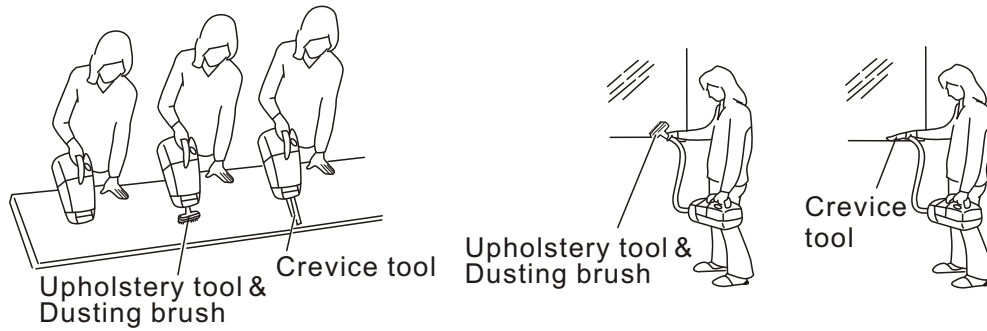

WALL-MOUNTABLE STORAGE

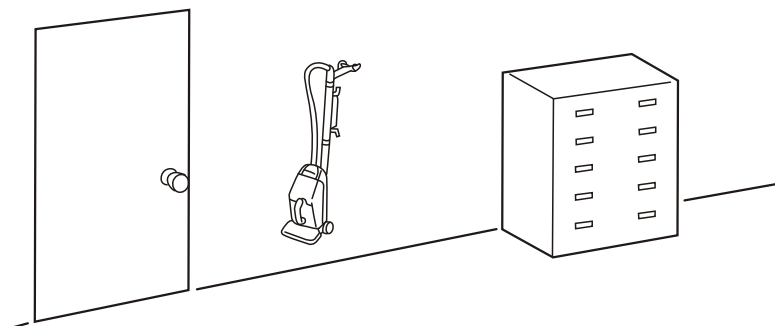

NAMES OF PARTS

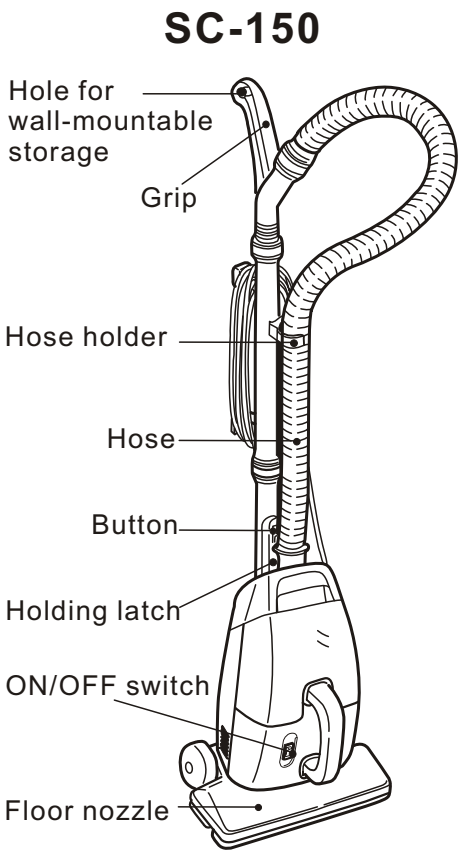

FRONT

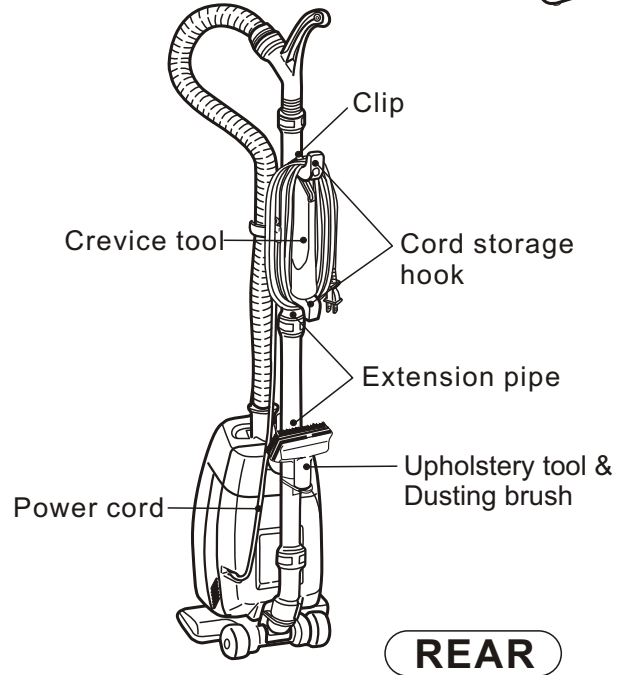
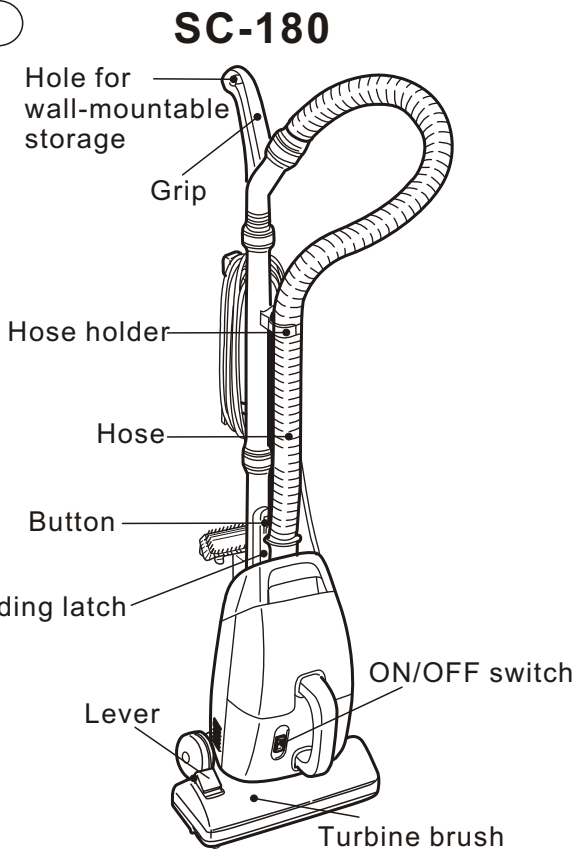

REAR

WARNING:
Operate vacuum cleaner only at the voltage specified on nameplate.

ASSEMBLING THE VACUUM CLEANER

Caution: Do not connect the power plug to the wall socket until assembly is completed.

- 1** Insert the hose into the main unit.

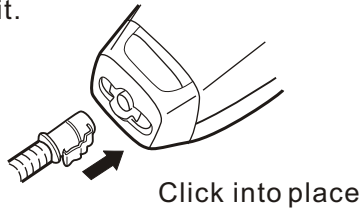

REMOVAL

Pull while pressing button.

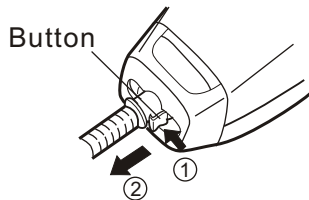

- 2** Attach the extension pipes and the floor nozzle as shown.

- Match the imprinted numbers as shown.

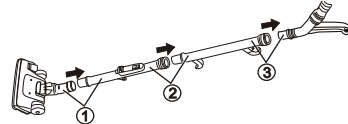

REMOVAL

Rotate the rings in the direction shown by the arrows and pull pipes apart.

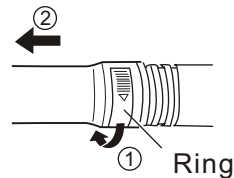

- 3** Fit the floor nozzle slot onto the floor nozzle mount.

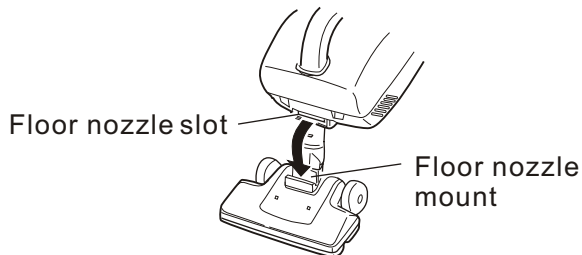

- 4** Set the holding latch into the latch slot.

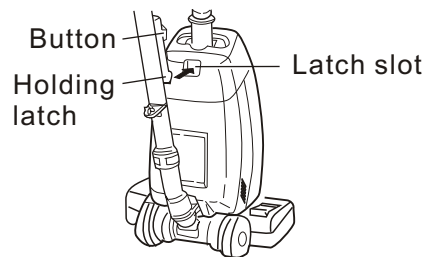

- 5** Hook the hose holder onto the hose holder mount

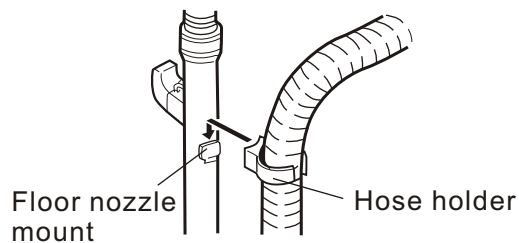

REMOVAL

- Slide the button in the direction shown by the arrow.

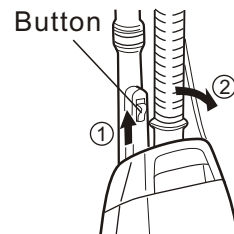

Caution: ● Do not lift or carry the vacuum cleaner by the hose or extension pipes. There is a hazard if the hose or extension pipes become detached.

- Be careful not to sandwich the electrical cord between the pipe and the main unit when inserting the holding latch into the latch slot.

USING THE VACUUM CLEANER

ON/OFF SWITCH

- 1 Set the ON/OFF switch to "I" to operate the vacuum cleaner.
- 2 Set the ON/OFF switch to "O" to stop the vacuum cleaner.

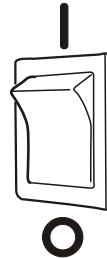

POWER CORD

WINDING THE POWER CORD

- 1 Hook the power cord over the clip which is located on the upper cord storage hook as shown.

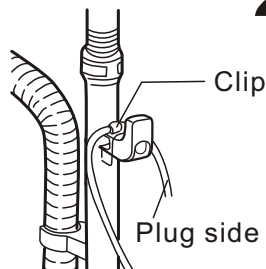

- 2 Wind the power cord around the cord storage hooks.

- Secure the power cord plug on the power cord.

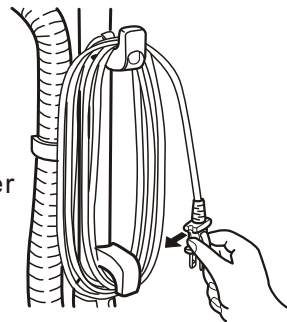

UNWINDING THE POWER CORD

- 1 Rotate the upper cord storage hook downward.

Upper cord storage hook

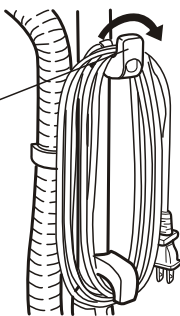

- 2 Return the hook to the upright position before attempting to rewind the power cord.

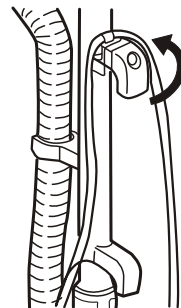

CREVICE TOOL

- First, attach the main unit to the extension pipes.
- When the crevice tool is not in use place it in the storage area between the cord storage hooks.

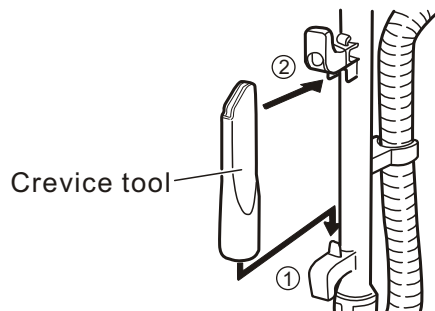

USING THE VACUUM CLEANER

UPHOLSTERY TOOL & DUSTING BRUSH (SC-180 only)

Press the tabs downward to remove the dusting brush from the upholstery tool.

Insert the front portion of the dusting brush into the groove located inside the front of the upholstery tool.

Pull up on the tabs to reattach the dusting brush to the upholstery tool.

After use, fix to the extension pipe for storage as shown in the illustration.

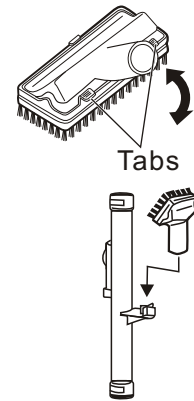

TURBINE BRUSH (SC-180 only)

The turbine brush has a lever with two positions.

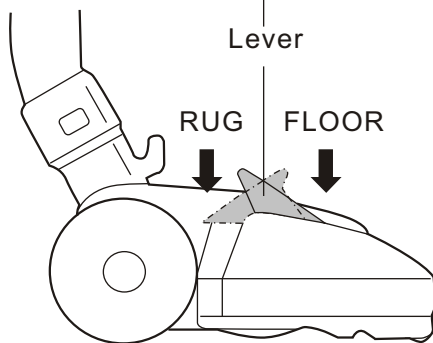
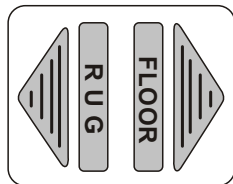

This rug attachment has a small, built-in turbine that is driven by the suction force of the unit. The turbine drives a brush inside the attachment to pick up fine particles more efficiently.

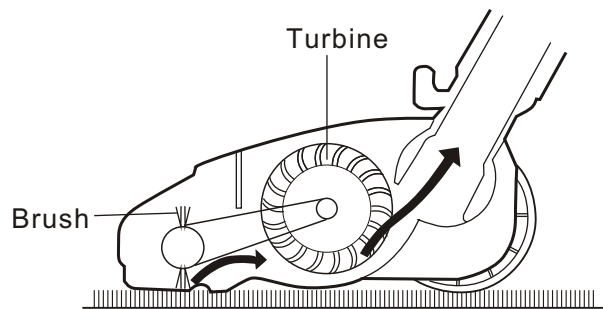

Caution:

- Do not touch the agitator while it is spinning.
- Do not vacuum bare floors with lever in "rug" position. Doing so may damage the floor.
- Do not leave the brush rotating for long periods over the same spot. Doing so may damage the carpet.

REPLACING THE PAPER BAG

Caution: Be sure to turn the ON/OFF switch to the "O" position and disconnect the power cord from the wall outlet when replacing the paper bag. Always make sure the paper bag is installed properly before using.

- 1** Pull the dust cover to remove it.



- 2** Remove the paper bag.

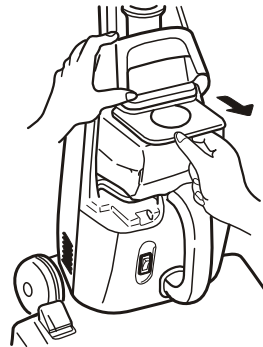

- 3** Throw away the used paper bag.

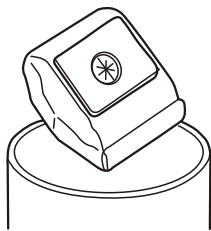

- 4** Fold down both sides of the new bag.

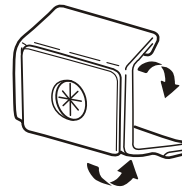

- 5** Slide the bag collar of the new bag into track completely.

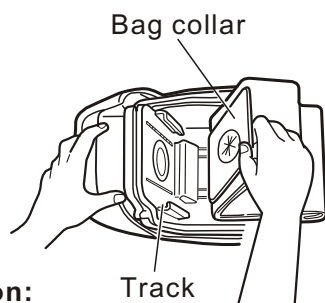

- 6** Return the dust cover to its original position.

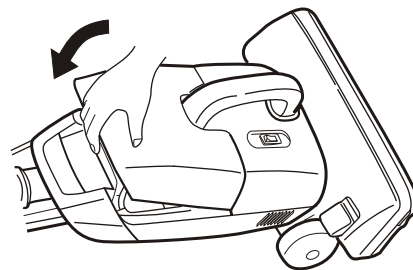

Caution:

- Be careful not to clamp the paper bag with the edge of the dust cover.
- Always use genuine Sanyo paper bags to assure maximum performance.
- Never use your vacuum cleaner without a paper bag.
- Never use a broken bag or attempt to reuse old paper bags.

Obtaining new paper bags

- You can obtain new paper bags from your nearest Sanyo dealer.
- Be sure to specify only genuine Sanyo vacuum cleaner bags. If bags from any other manufacturer are used, it may have adverse effects on vacuum cleaner performance.

SC-P11

PRODUCT MAINTENANCE

Caution: Be sure to turn the ON/OFF switch to the "O" position and disconnect the power cord from the wall outlet before cleaning.

MAIN UNIT

- 1** Wet a soft cloth with neutral detergent solution and wring out excess liquid.
- 2** Wipe the external surfaces of the unit.
- 3** Wipe with a dry cloth.

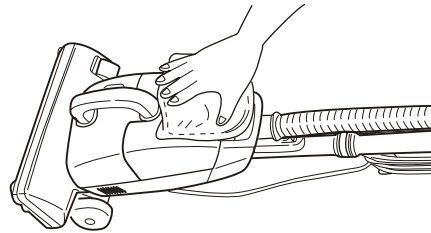
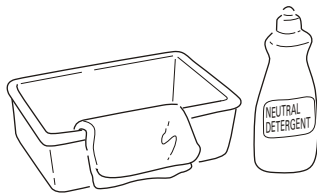

Caution: Do not use organic solvents, including thinner, or other strong cleaning liquids such as alkaline detergents. Use of such substances may cause discoloration or deterioration of materials resulting in deformation or cracking.

CLEANING THE AGITATOR ASSEMBLY

When threads get caught in the agitator assembly, clean the assembly. (SC-180 only)

Remove threads caught in the agitator assembly by cutting them with scissors.

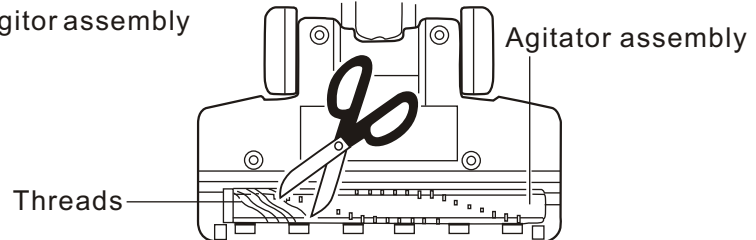

ELECTROSTATIC MICRON FILTER

The electrostatic micron filter should be replaced at least once every 8 months in order to maintain cleaning performance. Only use genuine Sanyo replacement filters.

- 1** Remove the dust cover and replace the electrostatic micron filter.
Electrostatic micron filter

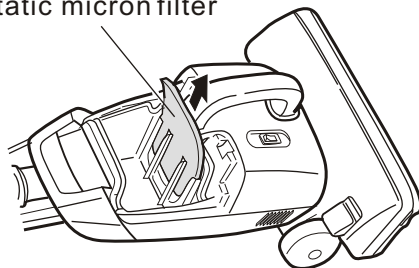

- 2** Replace the dust cover.

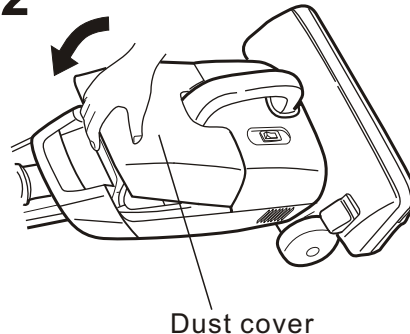

Caution: The electrostatic micron filter cannot be reused.

TROUBLESHOOTING

- If there is a problem with the vacuum cleaner, carry out the following checks to find the cause. If the problem still persists after the checks have been made, do not use the vacuum cleaner to prevent the possibility of an accident occurring. Turn the ON/OFF switch to the "O" position, disconnect the power cord from the wall outlet, and contact the place of purchase or your nearest Sanyo self-servicing dealer, or call(toll-free) 1-800-421-5013 (USA Only).

Problem	Possible cause
Motor does not operate when the switch is depressed to the "ON" position.	<ul style="list-style-type: none"> • Is the cord plugged completely into the power outlet? -Check the connection of the cord into the power outlet for complete insertion. • Is the cord damaged where it is connected to the plug, or are you pulling on the cord too hard or bending it? -Have the cord replaced at a Sanyo self-servicing dealer or a Sanyo service station.
Suction does not improve after replacing the bag.	<ul style="list-style-type: none"> • Is the electrostatic micron filter dirty? -Replace the electrostatic micron filter. • Is the turbine brush or the hose clogged? -If so, clean it out.
The agitator dose not operate. (SC-180 only)	<ul style="list-style-type: none"> • The lever is not set to the RUG position? -Set the lever to the RUG position. • Is the turbine brush or the hose clogged? -If so, clean it out.

REPLACEMENT PARTS

- Be sure to use only genuine Sanyo replacement parts.
- Paper bags, electrostatic micron filters and other replacement parts can be obtained from your nearest Sanyo dealer.
- If there is on Sanyo dealer in your vicinity, please contact a Sanyo service center or call(toll-free) 1-800-5013 (USA Only).

Part Name & Illustration

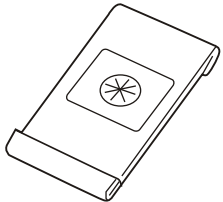
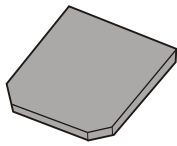
SC-P11  Paper bag	SC-F2  Electrostatic micron filter
--	---

SANYO UPRIGHT VACUUM CLEANER LIMITED WARRANTY

OBLIGATIONS

(USA ONLY)

In order to obtain warranty service, the product must be delivered to and picked up from an Authorized Sanyo Factory Service Center at the user's expense, unless specifically stated otherwise in this warranty. The names and addresses of Authorized Sanyo Service Centers may be obtained by calling the toll-free number listed below.

For product operation, authorized service center referral, service assistance or problem resolution, call

CUSTOMER INFORMATION 1-800-421-5013
Weekdays 8:00 AM - 5:00 PM Pacific Time
www.sanyoservice.com

For accessories and/or parts not available from an authorized dealer, call

PARTS ORDER INFORMATION 1-800-726-9662
Weekdays 8:00 AM - 5:00 PM Pacific Time

THIS WARRANTY IS VALID ONLY ON SANYO PRODUCTS PURCHASED AND USED IN THE UNITED STATES OF AMERICA. THIS WARRANTY APPLIES ONLY TO THE ORIGINAL RETAIL USER AND DOES NOT APPLY TO PRODUCTS USED FOR ANY INDUSTRIAL, PROFESSIONAL OR COMMERCIAL PURPOSE. THE ORIGINAL DATED BILL OF SALE OR SALES SLIP MUST BE SUBMITTED TO THE AUTHORIZED SANYO SERVICE CENTER AT THE TIME WARRANTY SERVICE IS REQUESTED.

Subject to the OBLIGATIONS above and EXCLUSIONS below, SANYO FISHER COMPANY (SFC) warrants this SANYO products against defects in materials and workmanship for the periods of LABOR and PARTS specified below. SFC will repair or replace (at its option) the product and any of its parts which fail to conform to this warranty.

The warranty period commences on the date the product was first purchased at retail

LABOR	PARTS	MOTOR
1YEAR	1YEAR	2YEAR

EXCLUSIONS

This warranty does not cover (A) the adjustment of customer-operated controls as explained in the appropriate model's instruction manual, or (B) the repair of any product whose serial number has been altered, defaced or removed.

This warranty shall not apply to the following items: non-electrical / mechanical attachments; accessories; appearance items; disposable parts such as filters, paper bags, belts, headlight lamps and agitator brushes.

This warranty shall not apply to setup, installation, removal or the product for repair or reinstallation of the product after repair.

This warranty does not apply to repairs or replacements necessitated by any cause beyond the control of SFC including, but not limited to, any malfunction, defect or failure caused by or resulting from unauthorized service or parts, improper maintenance, operation contrary to furnished instructions, shipping or transit accidents, modification or repair by the user, abuse, misuse, neglect, accident, incorrect power line voltage, fire, flood or other Acts of God, or normal wear and tear.

The foregoing is in lieu of all other expressed warranties and SFC does not assume or authorize any party to assume for it any other obligation or liability.

THE DURATION OF ANY WARRANTIES WHICH MAY BE IMPLIED BY LAW (INCLUDING THE WARRANTIES OF MERCHANTABILITY AND FITNESS) IS LIMITED TO THE TERM OF THIS WARRANTY. IN NO EVENT SHALL SFC BE LIABLE FOR SPECIAL, INCIDENTAL OR CONSEQUENTIAL DAMAGES ARISING FROM OWNERSHIP OR USE OF THIS PRODUCT, OR FOR ANY DELAY IN THE PERFORMANCE OF ITS OBLIGATIONS UNDER THIS WARRANTY DUE TO CAUSES BEYOND ITS CONTROL.

SOME STATES DO NOT ALLOW LIMITATIONS ON HOW LONG AN IMPLIED WARRANTY LASTS AND/OR DO NOT ALLOW THE EXCLUSION OR LIMITATION OF CONSEQUENTIAL DAMAGES, SO THE ABOVE LIMITATIONS AND EXCLUSIONS MAY NOT APPLY TO YOU.

THIS WARRANTY GIVES YOU SPECIFIC LEGAL RIGHTS. YOU MAY HAVE OTHER RIGHTS, WHICH VARY FROM STATE TO STATE.

For your protection in the event of theft or loss of this product, please fill in the information below for your own personal records.

Model No. _____ Serial No. _____
(Located on back or bottom side of unit)

Date of Purchase _____ Purchase Price _____

Where Purchased _____



21605 Plummer Street.
Chatsworth, CA 91311
www.sanyo.com