



USER'S GUIDE

COLOR MONITOR

Model No : 21dn



IMPORTANT SAFEGUARDS

1. Read all of these instructions.

2. Save these instructions for later use.



3. Unplug this monitor from the wall outlet before cleaning. Do not use liquid cleaners or aerosol cleaners. Use a damp cloth for cleaning.

4. Do not use attachments not recommended by the monitor manufacturer as they may cause hazards.

5. Do not use this monitor near water, e.g., near a bathtub, washbowl, kitchen sink, or laundry tub, in a wet basement, or near a swimming pool, etc.



6. Do not place this monitor on an unstable cart, stand, or table. The monitor may fall, causing serious injury to a child or adult, and serious damage to the appliance.



7. Slots and openings in the cabinet and the back or bottom are provided for ventilation, to ensure reliable operation of the monitor, and to protect it from overheating.

These openings must not be blocked or covered. The openings should never be blocked by placing the monitor on a bed, sofa, rug, or other similar surface. This monitor should never be placed near or over a radiator or heat register. This monitor should not be placed in a built-in installation such as a bookcase unless proper ventilation is provided.



8. This monitor should be operated only from the type of power source indicated on the marking label. If you are not sure of the power supplied to your home, consult your dealer or local power company.



9. This monitor is equipped with a 3-wire grounding-type plug. That is, a plug having a third (grounding) pin. This plug will only fit into a grounding-type power outlet. This is a safety feature. If you are unable to insert the plug into the outlet, contact your electrician to replace your obsolete outlet. Do not defeat the purpose of the grounding-type plug.



10. Do not allow anything to rest on the power cord. Do not locate this monitor where the cord will be abused by people walking on it.

11. Follow all warnings and instructions marked on the monitor.



12. For added protection for this monitor during a lightning storm, or when it is left unattended and unused for long periods of time, unplug it from the wall outlet. This will prevent damage to the monitor and/or the computer due to lightning and power line surges.

13. Do not overload wall outlets and extension cords as this can result in fire or electric shock.

14. Never push objects of any kind into this monitor through cabinet slots, as they may touch dangerous voltage points or short out parts that could result in a fire or electric shock. Never spill liquid of any kind on the monitor.



15. Do not attempt to service this monitor yourself, as opening or removing covers may expose you to dangerous voltages or other hazards. Refer all servicing to qualified service personnel.

16. Unplug this monitor from the wall outlet and refer servicing to qualified service personnel under the following conditions:

a. When the power cord or plug is damaged or frayed.

b. If liquid has been spilled into the monitor.

c. If the monitor has been exposed to rain or water.

d. If the monitor does not operate normally by following the operating instructions. Adjust only those controls that are covered by the operating instructions, as improper adjustment of other controls may result in damage and will often require extensive work by a qualified technician to restore normal operation.

e. If the monitor has been dropped or the cabinet has been damaged.

f. When the monitor exhibits a distinct change in performance, this indicates a need for service.



17. When replacement parts are required be sure the service technician has used replacement parts specified by the manufacturer that have the same characteristics as the original part. Unauthorized substitutions may result in fire, electric shock, or other hazards.

18. Upon completion of any service or repairs to this monitor, ask the service technician to perform routine safety checks to determine that the monitor is safe to operate.

FEDERAL COMMUNICATIONS COMMISSION RADIO FREQUENCY INTERFERENCE STATEMENT

NOTE : This equipment has been tested and found to comply with the limits for a Class B digital device, pursuant to Part 15 of the FCC Rules. These limits are designed to provide reasonable protection against harmful interference in a residential installation. This equipment generates, uses and can radiate radio frequency energy and, if not installed and used in accordance with the instructions, may cause harmful interference to radio communications. However, there is no guarantee that interference will not occur in a particular installation. If this equipment does cause harmful interference to radio or television reception, which can be determined by turning the equipment off and on, the user is encouraged to try to correct the interference by one or more of the following measures :

- Reorient or relocate the receiving antenna.
- Increase the separation between the equipment and receiver.
- Connect the equipment to an outlet on a circuit different from that to which the receiver is connected.
- Consult the dealer or an experienced radio or TV technician for help.

CAUTION : Any changes or modifications not expressly approved by the party responsible for compliance could void the user's authority to operate the equipment.

CANADIAN NOTICE

This Class B digital apparatus meets all requirements of the Canadian Interference-Causing Equipment Regulations.

AVIS CANADIEN

Cet appareil numérique de la Class B respecte toutes les exigences du Règlement sur le matériel brouilleur du Canada.

The power cord is used as a main disconnect device. Disconnect the power cord before servicing. The outlet must be installed near the monitor and must be easily accessible.

As an **ENERGY STAR**[®] Partner, Computer Technology Link, Inc. has determined that this product meets the Energy Star[®] guidelines for energy efficiency.

CONTENTS

Introduction	1
Product Features	2
Setup	3
Connecting the D-sub Signal Cable	3
Connecting the BNC Signal Cable	4
Connecting the Power Cord	5
Power Management System	5
DDC for Plug & Play	5
Operation & Adjustment	6
Specifications	12
Factory Preset Timings	12
Troubleshooting	13
Description for D-sub Connector	14

INTRODUCTION

This manual explains how to correctly install, operate and get the best performance from your monitor. Please read this user's guide carefully before installing your monitor, then keep it near your monitor for quick reference.

First, please check that the contents of the box corresponds with the following checklist :

- Color monitor
- Power cord
- Signal cable
- User's Guide
- Warranty Handbook
- Registration Card

If any item is missing or damaged, please contact your dealer. Please keep the box and packing materials so that you may properly store or transport your monitor.

PRODUCT FEATURES

- The convenient and user-friendly on-screen display allows for easy and accurate adjustments of horizontal and vertical screen size and position, geometry and screen color.
- The monitor supports a safe working environment in strict compliance with the MPR II standard for low emissions (TCO optional).
- The monitor complies with the VESA Display Data Channel (DDC) specification for Plug and Play compatibility. Advanced microcircuitry makes setup and configuration fast and effortless.
- The monitor features Advanced Color Controls for fine-tuning to meet your own personal tastes or application requirements. Use the on-screen controls to adjust the color temperature, RGB gain value for the best possible screen color and intensity.
- Press the menu button and activate the Self-Diagnosis menu to determine whether your monitor is functioning normally, not receiving a signal or is receiving a signal that is out of scanning range.
- Activate the higher refresh rates of the monitor to stabilize the screen and eliminate the annoying flicker that contributes to eye-strain and headaches.
- The “borderless” full-screen display capability works under all graphic modes and provides a larger viewing area than conventional monitors, giving you a better picture with more workspace.

SETUP

CONNECTING THE D-SUB SIGNAL CABLE

1. Turn off the computer and monitor.
2. Connect the 15 pin D-sub connector to the output port of the video card in your computer and monitor.
3. Tighten the screws of connector.

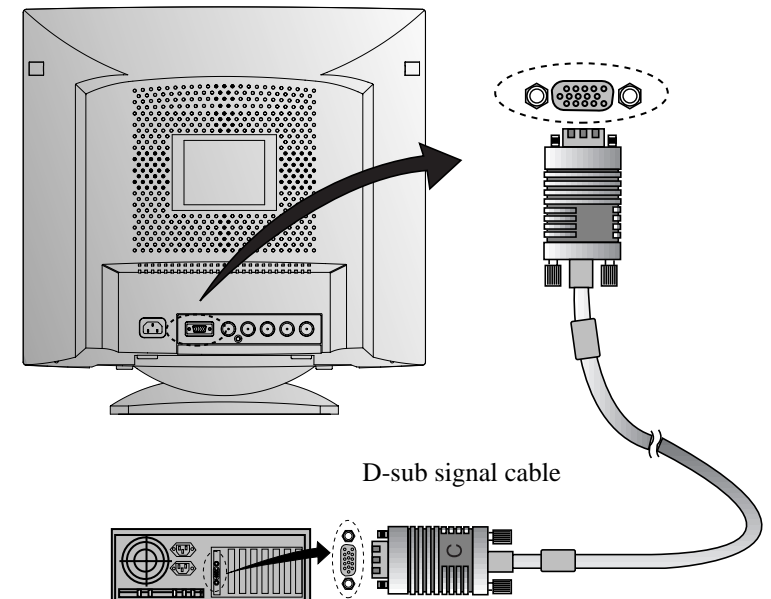

CONNECTING THE BNC SIGNAL CABLE

1. Turn off the computer and monitor.
2. Connect the 5 BNC connectors from the signal cable to the monitor.
3. Push in and turn the connectors clockwise until they are locked in place.

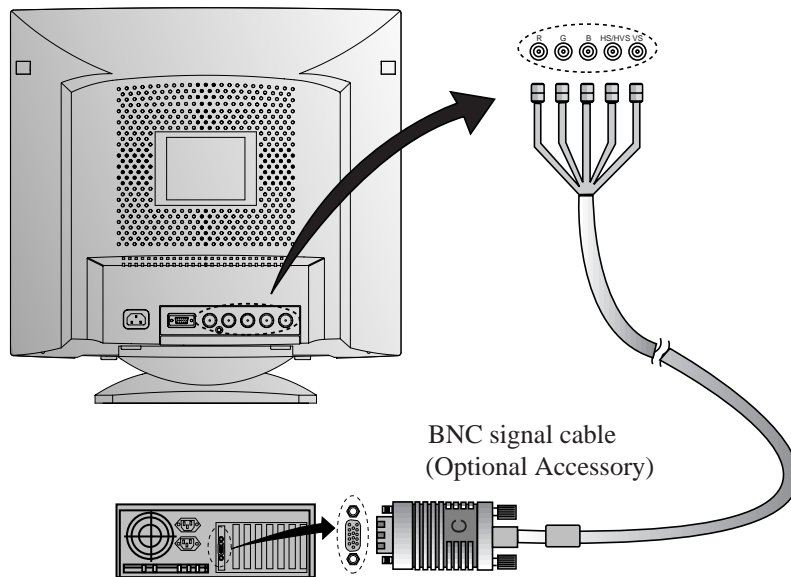

CONNECTING THE POWER CORD

1. Plug the power cord into the AC receptacle located at the back of the monitor.
2. Plug the other end of the power cord into the AC outlet.

If your power cord is PC-to-Monitor type, plug the other end of the power cord into the AC receptacle in the computer.

POWER MANAGEMENT SYSTEM

If you use the monitor with a computer that complies with the power-saving program, you can set the monitor to go blank when the system has remained unused for a period of time. To specify the period or to disable this feature, set the system timeout field of the computer's system setup program or use special software for power-saving. See the computer user's manual for the details of using the system setup. While the monitor is in power-saving mode (blank screen), it consumes less power than when it is in its normal state. The color of the power LED will indicate the state. To restore the screen image, press any key of your keyboard or move your mouse. If the signal cable is connected loosely or disconnected, the power-saving feature will not operate.

DISPLAY DATA CHANNEL FOR PLUG AND PLAY

If you use the monitor with a computer that complies with DDC1/2B/CI of VESA, the host video card automatically configures itself without your intervention in a way that best fits the attached monitor. The Display Data Channel (DDC) allows the monitor to inform the host system about configuration information for optimum use of the monitor. Use of the video card utility is not required to match the resolutions and refresh rates of the monitor and video card.

OPERATION & ADJUSTMENT

Control Panel



- Move cursor to the right window on the OSD window.
- Increase the value of any selected function.
- Move cursor to the left window on the OSD window.
- Decrease the value of any selected function.
- Launch OSD(On-Screen Display) MENU window.
- Move cursor to the high window on the OSD window.
- Increase the value of V.size or V.center.
- Move cursor to the low window on the OSD window.
- Decrease the value of V.size or V.center.

Hot Key

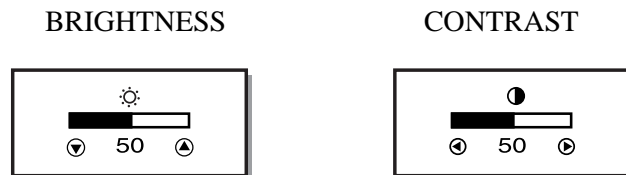



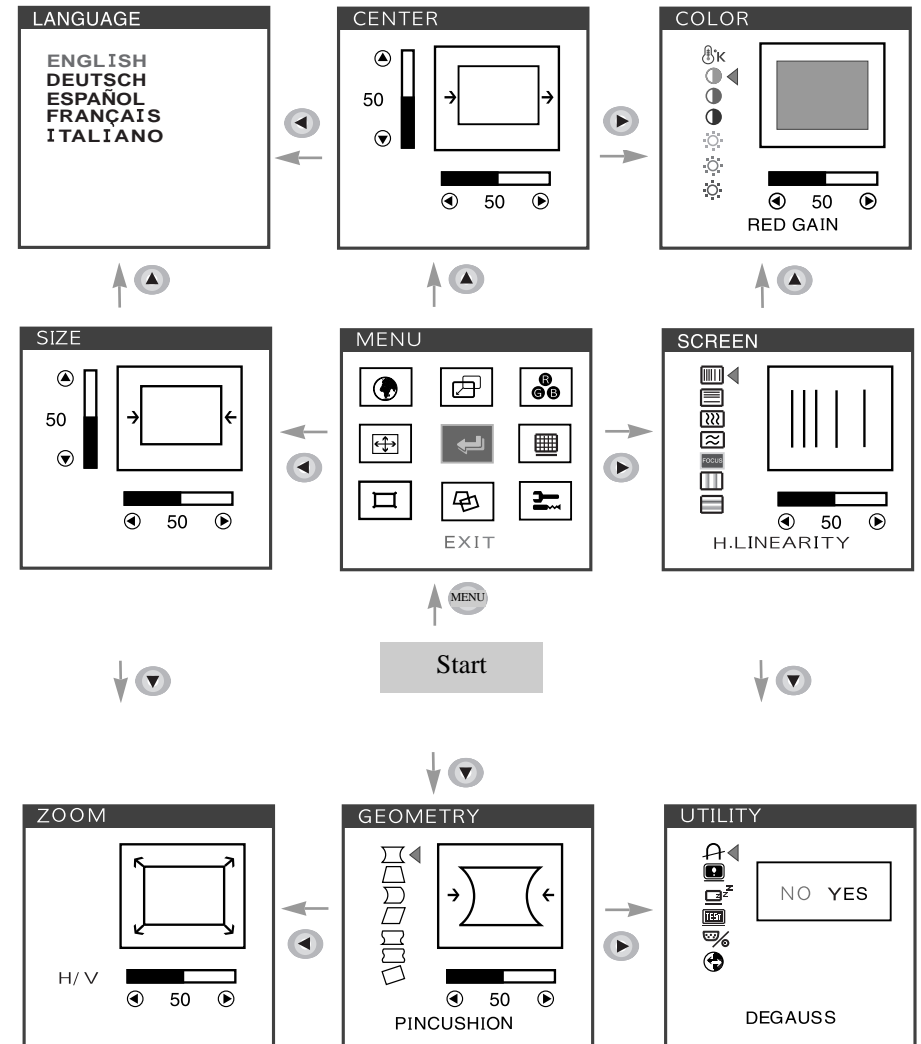



















Key Process



- When you choose the icon on the OSD window, you can exit the OSD screen.

OSD Functions

ICON	CONTROL	FUNCTION
	LANGUAGE	Select language for OSD (5 languages).
	H. CENTER & V. CENTER	Adjust the position of the display horizontally(left or right) and vertically (up or down).
	COLOR TEMP	Choose different preset color temperatures or set your own customized color parameters.
	RED GAIN	Adjust the red gain.
	GREEN GAIN	Adjust the green gain.
	BLUE GAIN	Adjust the blue gain.
	RED BIAS	Adjust the red bias.
	GREEN BIAS	Adjust the green bias.
	BLUE BIAS	Adjust the blue bias.
	H. SIZE & V. SIZE	Adjust the width (horizontal size) and the height (vertical size) of the display.
	H. LINEARITY	Adjust the horizontal linearity.
	V. LINEARITY	Adjust the vertical linearity.

ICON	CONTROL	FUNCTION
	H. MOIRE	Adjust the horizontal picture moire cancellation.
	V. MOIRE	Adjust the vertical picture moire cancellation.
	FOCUS	Adjust the focus image.
	H.CONVERGENCE	Adjust the horizontal convergence image.
	V.CONVERGENCE	Adjust the vertical convergence image.
	ZOOM	Adjust the display width & height at the same time.
	PINCUSHION	Adjust the left and right margins for more convex or more concave margins.
	TRAPEZOID	Adjust the trapezoid of the screen by moving the lines inward or outward.
	PIN BALANCE	Adjust the side balance when the sides of the screen are bowed towards left or right.
	PARALLELOGRAM	Adjust the parallelogram when the screen is leaning left or right.
	PIN S CONTROL	Adjust the pin S control when the sides of the screen are in a S shape.

ICON	CONTROL	FUNCTION
	PIN W CONTROL	Adjust the pin W control when the sides of the screen are in a W shape.
	ROTATION	Adjust the rotation when the screen is tilted left or right.
	DEGAUSS	Degaussing keeps the monitor free from unwanted magnetism that can result in color impurity.
	STATUS	Display horizontal & vertical frequency and polarity.
	POWER SAVER	YES : VESA DPMS operation. NO : NO DPMS operation.
	TEST PATTERN	Display a RGB Color Bar to determine whether the screen color is expressed normally or not.
	BNC/D-SUB	Select a input signaling type between D-sub and BNC connector.
	RECALL	Reset the screen to the Factory Preset Display Settings.

Self Diagnosis

When the monitor doesn't display, if you press any key, Self Diagnosis screen is displayed. Self Diagnosis function checks if the status of the monitor is No Signal or Out of range.



No Signal screen is displayed when the D-Sub signal connector is not connected or the status of the monitor is on DPMS mode.

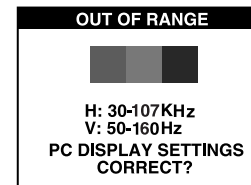

Out of Range screen is displayed when the applied frequency is under or over normal range.

■ Normal range
H : 30 - 107 KHz
V : 50 - 160 Hz

SPECIFICATIONS

CDT Size		21-inch
Diagonal visible image area		20-inch
Dot Pitch		0.25 mm
Synchronization	Horizontal	30 - 107 KHz
	Vertical	50 - 160 Hz
Plug and Play		DDC1/2B/CI
Power Saving		EPA, VESA DPMS, Nutek Compliant
Power Source		100-240 Vac, 50/60Hz (Free Voltage)
Power Consumption		135 W
Dimension-W x H x D (set with stand)		494 x 500 x 518mm
Weight-unpacked (lbs/Kg)		61.7/28.0
Operating Temperature		10 ~ 40°C / 50 ~ 104°F

※ This specification can be changed without any prior notice to improve the quality of the product.

FACTORY PRESET TIMINGS

Mode	Resolution (dots X lines)	H.Freq (KHz)	V.Freq (Hz)	Remark
VGA 480	640 X 480	31.5	60	Non-interlaced
VGA 400	720 X 400	31.3	70	Non-interlaced
VESA 43K	640 X 480	43.0	85	Non-interlaced
VESA 46K	800 X 600	46.9	75	Non-interlaced
VESA SVGA 85	800 X 600	53.7	85	Non-interlaced
VESA 60K	1024 X 768	60.0	75	Non-interlaced
VESA 1024/85	1024 X 768	68.7	85	Non-interlaced
VESA 1280/75	1280 X 1024	80.0	75	Non-interlaced
VESA 1600/70	1600 X 1200	87.5	70	Non-interlaced
VESA 1280/85	1280 X 1024	91.1	85	Non-interlaced
VESA 1600/75	1600 X 1200	93.8	75	Non-interlaced
VESA 1600/85	1600 X 1200	106.3	85	Non-interlaced

TROUBLESHOOTING

Symptom	Check
No picture.	Check if power switch and computer power switch are in the on position.
	↓
	Check if the signal cable is correctly connected to the video card.
	↓
POWER LED is not lit.	Check if the pins of D subconnector are not bent.
	↓
	Check if the computer is in the power- saving mode.
Image is unstable.	Check if the signal cable is suitable to the video card.
Image is not centered, too small or too large.	Adjust H & V Size or H&V Center to get the proper image.
Picture bounces or a wave pattern is present in the picture.	Keep the devices that may cause electrical interference away from the monitor. ↓ See the FCC information at the front cover of the manual.
Color looks blotchy.	Operate Degauss once.
Picture is blurred.	Adjust Contrast and Brightness.
	↓ Operate Degauss once.
Edges of available area on the screen are not straight.	Adjust Geometry Control (Pincushion, Trapezoid..).

DESCRIPTION FOR D-SUB CONNECTOR

Pin	Signal
1	Red
2	Green
3	Blue
4	GND
5	GND
6	GND-Red
7	GND-Green
8	GND-Blue
9	+5Vdc
10	GND-H.Sync
11	GND-V.Sync
12	Bi-directional Data(SDA)
13	Horizontal Sync
14	Vertical Sync(VCLK)
15	Data Clock(SCL)

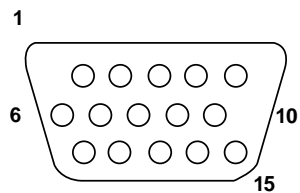

* GND=Ground

S/N : 9978628318