

## V8000HD<sup>e</sup> MONITOR User Guide



# ikan V8000HDe 8" LCD Monitor

## INTRODUCTION

Thank you for purchasing our ikan V8000HDe LCD Monitor. We know you will be satisfied with our "V" series monitors. Please visit [www.ikancorp.com](http://www.ikancorp.com) for more information on our current and future products including our award winning fluorescent studio lights and light accessories.

## PACKAGE CHECK LIST

- V8000HDe LCD Monitor
- AC Adapter
- DV Battery Plate (*check one*): [ Sony ] [ Canon ] [ JVC ] [ Panasonic ]
- Camera Shoe Mount
- Battery Strap
- User Guide

Checked by

## MONITOR DIAGRAMS



1.	POWER	Power switch On / Off
2.	LAMP	Power signal indicator
3.	MENU	Access to all monitor settings: Brightness, Hue, etc.
4.	>	Flip image horizontally While in MENU mode, toggle as up adjust setting
5.	<	Flip image vertically While in MENU mode, toggle as down adjust setting
6.	GUIDES	On-screen guide: 4:3 or Widescreen
7.	ASPECT	Aspect ratio: 4:3 or Widescreen
8.	INPUT	Video mode: HDMI, A/V (Composite), S-Video, SD/HD Component

## ADDITIONAL ACCESSORIES

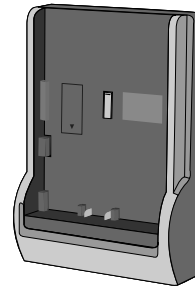

**Panasonic Battery Plate**  
(Panasonic CGR-D54)  
**\$29.95**

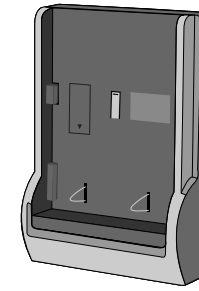

**JVC Battery Plate**  
(JVC BN-V438U)  
**\$29.95**

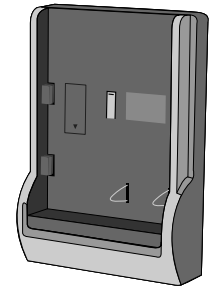

**Canon Battery Plate**  
(Canon BP-945)  
**\$29.95**

### PBPK-S Pro Battery Plate Kit \$149.00

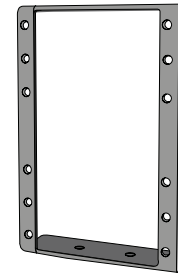

Invert Bracket

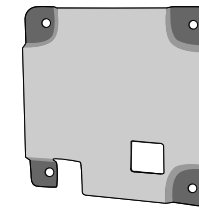

Pro Adapter Plate

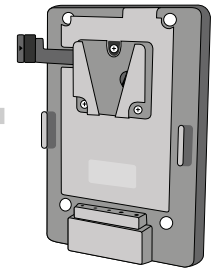

V-Mount Battery Plate

### PBPK-A Pro Battery Plate Kit \$149.00

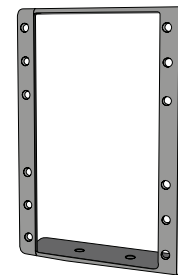

Invert Bracket

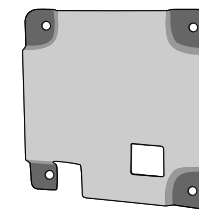

Pro Adapter Plate

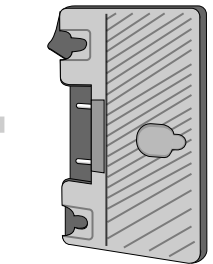

Gold Mount Battery Plate

**Note:** For more information on these accessories please visit our website [www.ikancorp.com](http://www.ikancorp.com) or call us at 1-713-272-8822.

## SPECIFICATIONS

Screen Size:	Diagonal 8" TFT - LCD
Resolution:	800 x 480
Operating Volts:	DC 12-24V
Dimension:	8.25" x 5.7" x 1.25"
Weight:	1.3 lbs.
Aspect Ratios:	4:3 and 16:9
LCD Brightness:	400cd/m2
Viewing Angle:	65/65(R/L)
Power Consumption:	< 7w

## KEY FEATURES

- A variety of connections including:
  - Composite, S-Video, and SD/HD Component
- Applicable battery mounts with:
  - DV Batteries: Sony, Canon, Panasonic, and JVC
  - Pro Batteries: V-Mount, and Gold Mount
- Supported Resolutions:
  - 480i, 480p, 720p, and 1080i
- A on-Screen safe area guide for both 4:3 and Widescreen
- Single push button for vertical and horizontal flip of image.
- Battery strap

## WARRANTY

Ikan products are engineered with you in mind for a trouble free performance and a productive product life. For your assurance, product warranties on all parts are available for all ikan products against defective material or workmanship. In case of a defect within the One-year warranty period, please contact the ikan Corporation for an RMA# and a speedy replacement for your ikan product.

### CONDITIONS OF WARRANTY SERVICE

- Free service for one year from the day of purchase if the problem is caused by manufacturing errors.
- The components and maintenance service fee will be charged if the warranty period has expired.

Free Service will not be Provided in the Following Situations:

**\*\* Even if the product is still within the warranty period.**

- Damage caused by abuse or misuse, dismantling, or changes to the product not made by the company.
- Damage caused by natural disaster, abnormal voltage, and environmental factors etc.

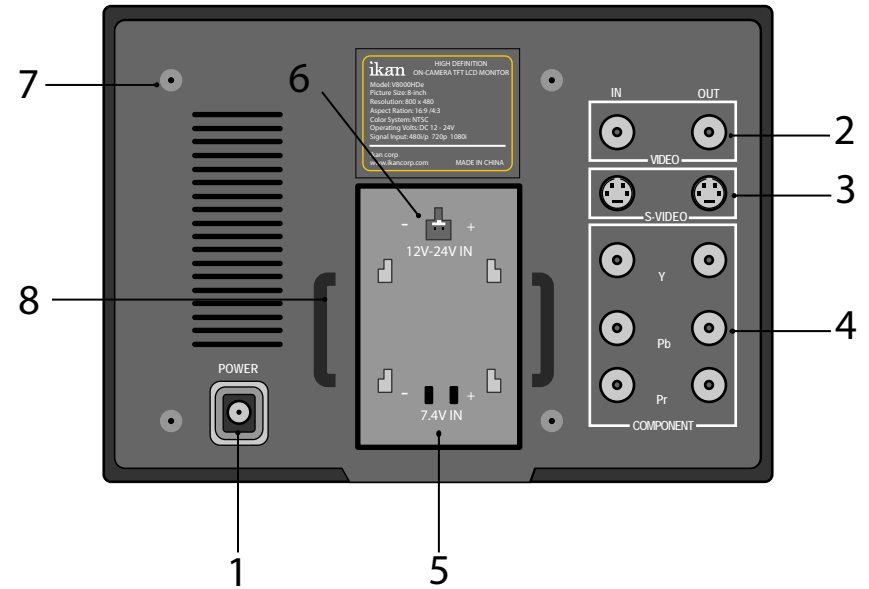

1.	DC 12V Power Connection
2.	A/V - In/Out for standard definition composite signal
3.	S-Video - In/Out for standard definition S-Video signal
4.	Component - In/Out for standard definition, 720p, and 1080i HD signals
5.	DV Battery Plate Slot
6.	Pro Battery DC Connection
7.	100mm Vesa Holes
8.	Hooks for Battery Strap

## GETTING STARTED

### 1. Powering The Monitor.

- Plug the AC adapter into the power input jack located on the left side of the monitor (when viewing from the rear). *See page 3.*
- Connect DV battery to the back of the monitor. And, use the battery strap to secure the battery. *See page 3.*
- Connect Pro battery to the back of the monitor. *See page 3.*

### 2. Connecting The Video Source

- The V8000 HDe allows you to connect your video cables directly to the rear of the monitor, with support for SD/HD Component, S-Video (Y/C), and Composite (A/V). *See page 4.*
- The V8000 HDe features professional BNC connectors for your video inputs. If your equipment does not feature these connectors, you can purchase BNC to RCA adapters at your local electronic store or directly from us at [www.ikancorp.com](http://www.ikancorp.com) or call us at 713-272-8822.

## AC POWER CONNECTION

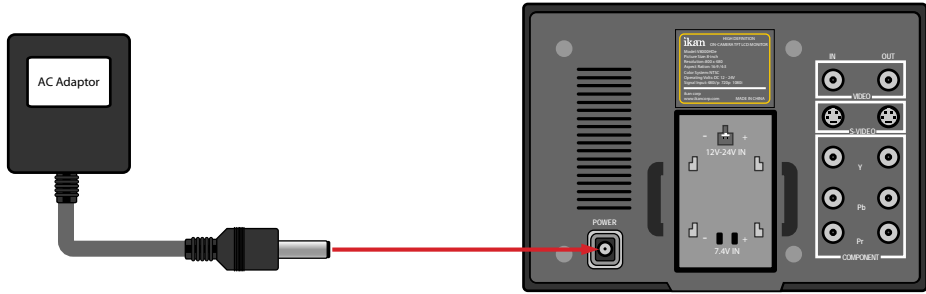

## DV BATTERY CONNECTION

\*\* DV Battery is not included in this package.

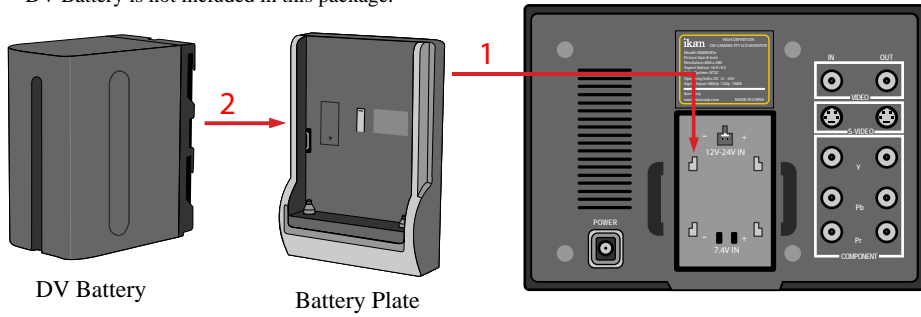

DV Battery

Battery Plate

1. Place the battery plate on the battery plate slot, and slide down to lock in place.
2. Install DV Battery on the battery plate.
3. Secure DV Battery with the battery strap.

3. a

b

c

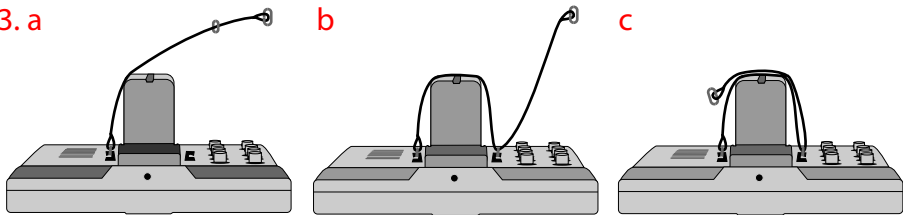

## PRO BATTERY CONNECTION

\*\* Additional Accessories

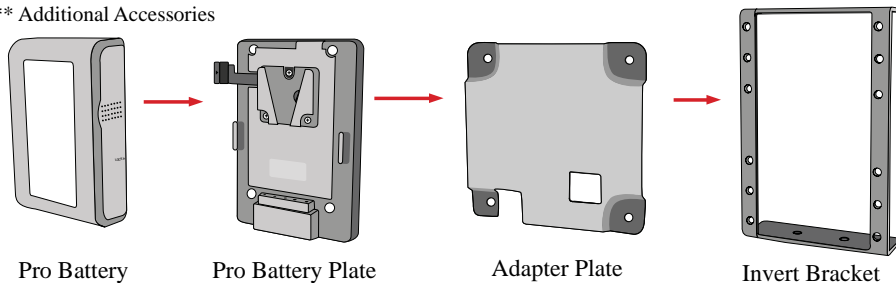

Pro Battery

Pro Battery Plate

Adapter Plate

Invert Bracket

## CONNECTING DIAGRAM

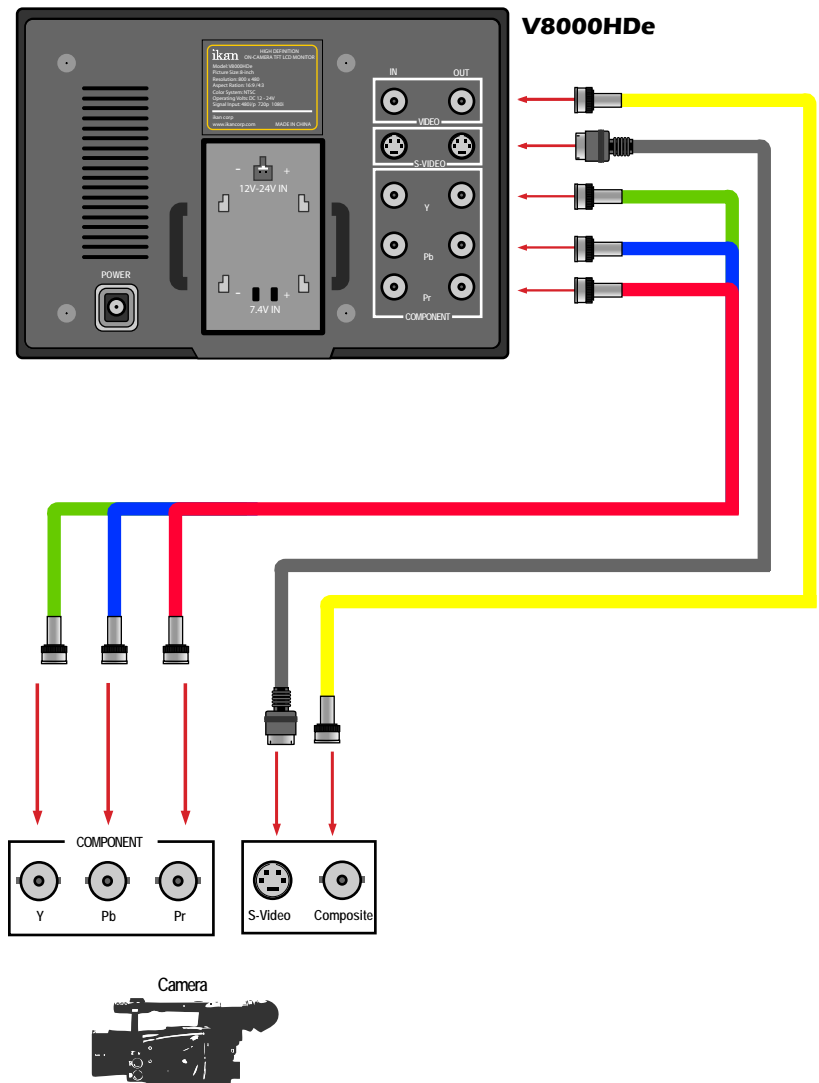

\*\*If your equipment does not feature BNC connectors, you need a BNC to RCA adapter.