

BenQ

FP2091/FP2092

LCD Color Monitor

20.0" LCD Panel Size

User's Manual

Welcome

i Copyright

Copyright © 2006 by BenQ Corporation. All rights reserved. No part of this publication may be reproduced, transmitted, transcribed, stored in a retrieval system or translated into any language or computer language, in any form or by any means, electronic, mechanical, magnetic, optical, chemical, manual or otherwise, without the prior written permission of BenQ Corporation.

ii Disclaimer

BenQ Corporation makes no representations or warranties, either expressed or implied, with respect to the contents hereof and specifically disclaims any warranties, merchantability or fitness for any particular purpose. Further, BenQ Corporation reserves the right to revise this publication and to make changes from time to time in the contents hereof without obligation of BenQ Corporation to notify any person of such revision or changes.

Please follow these safety instructions for best performance, and long life for your monitor

iii Power Safety

- The AC plug isolates this equipment from the AC supply.
- The power supply cord serves as a power disconnect device for pluggable equipment. The socket outlet should be installed near the equipment and be easily accessible.
- This product should be operated from the type of power indicated on the marked label. If you are not sure of the type of power available, consult your dealer or local power company.

iv Care And Cleaning

- Cleaning. Always unplug your monitor from the wall outlet before cleaning. Clean the LCD monitor surface with a lint-free, non-abrasive cloth. Avoid using any liquid, aerosol or glass cleaners.
- Slots and openings on the back or top of the cabinet are for ventilation. They must not be blocked or covered. Your monitor should never be placed near or over a radiator or heat source, or in a built-in installation unless proper ventilation is provided.
- Never push objects or spill liquid of any kind into this product.

v Servicing

- Do not attempt to service this product yourself, as opening or removing covers may expose you to dangerous voltages or other risks. If any of the above mentioned misuse or other accident such as dropping or mishandling occurs, contact qualified service personnel for servicing.

i Table of Contents

Getting started	5
Getting to know your monitor	7
Front View	7
Back View (1)	7
Back View (2): Locations of plugs & sockets	8
How to install your monitor hardware	9
Adjusting Your Monitor	11
Getting the most from your BenQ monitor	13
How to install the monitor on a new computer	14
How to upgrade the monitor on an existing computer	15
How to install on Windows XP systems	16
How to install on Windows 2000, ME, & 98 systems	17
How to complete the Windows Upgrade Device Driver Wizard	18
How to adjust the screen resolution	20
How to adjust the screen refresh rate	21
How to set the picture optimization	22
How to adjust your monitor	23
A Look at the Control Panel	23
Hot Key Mode	24
Main Menu Mode	24
Troubleshooting	33
Frequently Asked Questions (FAQ)	33
Need More Help?	34
Supported operating modes	35
Specifications	36

1 Getting started

When unpacking please check you have the following items. If they are missing or are damaged, please immediately contact the dealer at which you purchased the goods.

BenQ LCD Monitor	
Monitor Stand	
Quick Start Guide	
CD-ROM Disk	
Power Cord	

Adapter	
USB Cable	
Signal Cable: D-Sub	
Signal Cable: DVI-D	
Audio Cable (optional)	
Speaker Unit: SRS (optional)	
Webcam Unit (optional)	

② Getting to know your monitor

Front View



Back View (1)



Back View (2): Locations of plugs & sockets



1. Power AC Input Jack
2. Composite Video Input
3. S-Video Input
4. DVI-D Connector
5. D-Sub Connector
6. Audio Connector
7. USB Connectors

3 How to install your monitor hardware

☞ If the computer is turned on you must turn it off before continuing.
Do not plug-in or turn-on the power to the monitor until instructed to do so.

1. Unpack the package and place the monitor stand firmly.



2. Align the slots on the monitor against the notches on the monitor stand.



3. Place the monitor on the monitor stand and push it forward until you hear a clicking sound.



4. Connect one end of the D-Sub cable to the monitor and the other end to your computer.

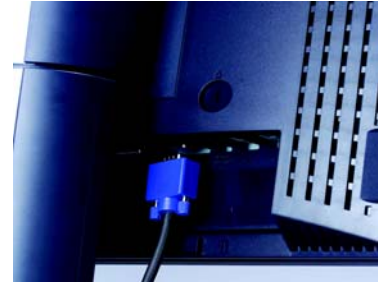

5. Connect one end of the DVI-D cable to the monitor and the other end to the signal connector of your computer. (Optional).



6. Connect one end of the USB cable into the second plug (from right to left) of the monitor and the other end to your computer.



7. Connect the power plug to your monitor.



8. Routing the cables in the Cable Bracket as shown.

9. Plug the other end of the power cord in a nearby wall socket.

10. Press the Power button on the side panel of the monitor. The power indicator will light up.



Adjusting Your Monitor

Monitor Height

To prevent from the springing out of the monitor stand, please press the top edge of monitor stand while you press the release button to adjust the monitor at a preferred height.

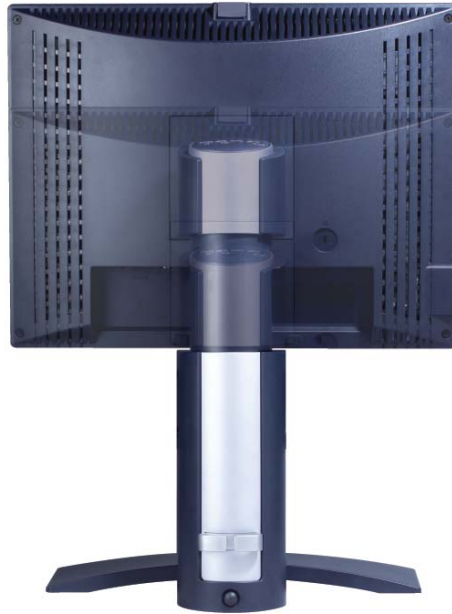

Monitor Angle

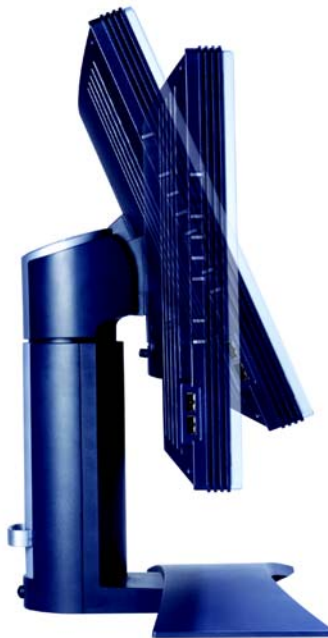

Adjusting Monitor Orientation

While making a rotation, please push the monitor to a forward tilt angle or lift up the monitor to avoid causing any damage to the monitor base.



4 Getting the most from your BenQ monitor

Monitors and USB hubs

Your BenQ FP2091/FP2092 LCD Monitor is a modern state-of-the-art device. It not only utilizes the latest LCD display technology currently available – it contains a built-in 3 port USB 2.0 hub. Using only one USB 2.0 port on your computer (freeing the others up for other uses), the built-in hub provides close, handy, easy-to-use access for your USB devices.

You could use the USB hub to plug-in your USB keyboard, USB mouse, and USB web camera all at the same time if you wish. Or if you connect your keyboard and mouse directly to your computer, you could use the USB ports on the monitor for connection to your digital camera, digital video camera, USB reader, USB printer, USB memory stick, or any other USB device.

What do I have to do?

All you have to do, is connect the monitor cables as instructed in [How to install your monitor hardware](#) of this User's Manual, turn the computer and monitor on, then you're ready to Plug-and-Play with USB, Windows, and your BenQ LCD Monitor's USB hub.

Windows 2000 and later comes with integrated USB support. It will automatically detect and identify your USB devices, and install the necessary drivers for them to work. If your USB device was accompanied by the manufacturer's driver or custom software for the device, you need only point Windows in the direction of that driver, and Windows will install it for you.

How do I gain the most benefit from my new monitor?

To gain the most benefit from your new BenQ color LCD flat screen monitor, you should install the custom BenQ LCD Monitor driver software as provided on the BenQ LCD Monitor CD-ROM.

The circumstances under which you connect and install your BenQ LCD Monitor will determine which process you need to follow to successfully install the BenQ LCD Monitor driver software. These circumstances relate to which version of Microsoft Windows you are using, and whether you are connecting the monitor and installing the software onto a new computer (without existing monitor driver software), or whether you are upgrading an existing installation (which already has existing monitor driver software) with a newer monitor.

In either case however, the very next time you turn on your computer (after connecting the monitor to your computer), Windows will automatically recognise the new (or different) hardware, and will launch its **Found New Hardware** wizard.

Follow the wizard instructions until it asks you to select a monitor model. At that point, click the **Have Disk** button, insert the BenQ LCD Monitor CD-ROM and select the appropriate monitor model. Further details and step-by-step instructions for both an automatic (new) or upgrade (existing) installation follow. See:

- [How to install the monitor on a new computer.](#)
- [How to upgrade the monitor on an existing computer](#)

 **If you require a User Name and Password to login to your Windows computer, you must be logged on as an Administrator or as a member of the Administrators group in order to install the monitor driver software. Furthermore, if your computer is connected to a network which has security access requirements, network policy settings may prevent you from installing software on your computer.**

How to install the monitor on a new computer

This instruction details the procedure for selecting and installing the BenQ LCD Monitor driver software on a new computer which has never had a monitor driver installed before. This instruction is only suitable for a computer which has never been used before, and for which the BenQ LCD Monitor is the first ever monitor to be connected to it.

 **If you are adding the BenQ LCD Monitor to an existing computer that has already had another monitor connected to it (and has monitor driver software installed), you should not be following these instructions. You should instead be following the instructions for How to upgrade the monitor on an existing computer.**

1. Follow the instructions in [How to install your monitor hardware](#).

When Windows (2000 or later) starts, it will automatically detect the new monitor and launch the **Found New Hardware Wizard**. Follow the prompts until it displays the option to **Install Hardware Device drivers**.

2. Insert the BenQ LCD Monitor CD-ROM into a CD drive on the computer.
3. Check **Search for a suitable driver for my device** option, and click **Next**.
4. Check the option for **CD-ROM drives** (uncheck all others) and click **Next**.
5. Look to confirm that the wizard has selected the correct name of your monitor as "BenQ FP2091/FP2092" and click **Next**.
6. Click **Finish**.

Windows will continue installing other devices it finds. If you connected the USB 2.0 hub cable to a suitable USB 2.0 port on the computer, Windows will automatically detect it and install the appropriate drivers for it. You need not do anything more to get the hub to work for you.

7. Restart the computer.

How to upgrade the monitor on an existing computer

This instruction details the procedure for manually updating the existing monitor driver software on your Microsoft Windows computer. It is currently tested as compatible (and recommended only) for Windows 98, Windows ME, Windows 2000, and Windows XP Operating System (OS).

 **The BenQ LCD Monitor driver for your model may well function perfectly with other versions of Windows, however, as at the time of writing, BenQ has done no testing of this driver on other versions of Windows and cannot guarantee its operation on those systems.**

Installing monitor driver software involves selecting an appropriate information file (.inf) on the BenQ LCD Monitor CD-ROM for the particular model monitor you have connected, and letting Windows install the corresponding driver files from the CD. You need only steer it in the right direction. Windows has an Upgrade Device Driver Wizard to automate the task and guide you through the file selection and installation process.

See:

- [How to install on Windows XP systems.](#)
- [How to install on Windows 2000, ME, & 98 systems.](#)

How to install on Windows XP systems

1. Open **Display Properties**.

The quickest shortcut to **Display Properties** is through the Windows desktop. Right-click the desktop and select **Properties** from the popup menu.

Alternatively, the Windows menu to **Display Properties** is located in **Control Panel**.

In Windows XP version, **Control Panel** is located directly under the main **Start** menu item. The menu options displayed will depend upon which type of view is selected for your system.

- Under the Classic view, click **Start | Control Panel | Display**.
- Under the Category view, click **Start | Control Panel | Appearance and Themes | Change the screen resolution**.

The **Display Properties** window will display.

2. Click the **Settings** tab and the **Advanced** button.

The **Advanced Display Properties** window will display.

3. Click the **Monitor** tab and select the 'Plug and Play Monitor' from the list.

If there is only one monitor in the list, it will already be selected for you.

4. Click the **Properties** button.

The **Monitor Properties** window will display.

If the driver provider is listed as BenQ, and the model matches that of your new monitor, the proper drivers are already installed, and you need do nothing further. Cancel out of these property windows.

However, if BenQ is not listed as the manufacturer, or the correct model is not currently shown, you will need to continue with these instructions.

5. Click the **Driver** tab and the **Update Driver** button.

The **Hardware Update Wizard** will display. Follow the wizard instructions noting the steps below:

6. Insert the BenQ LCD Monitor CD-ROM into a CD drive on the computer you attached the monitor to.

7. Check the option 'Install from a list or specific location' and click **Next**.

8. Check the option 'Search for the best driver in these locations' and also check 'Search removable media', then click **Next**.

Please wait while the wizard searches for drives and the BenQ LCD Monitor CD inserted in step 6. When complete, the wizard should have found and selected the BenQ driver on the CD appropriate to your monitor model, in this case 'BenQ FP2091/FP2092' in the location 'd:\driver\fp2091.inf\fp2092.inf' or similar.

 **The drive letter for your CD drive may differ from the example above depending upon your system – it may be 'D:' or 'E:' or 'F:' etc.**

9. Select (single-click) the file named 'BenQ FP2091/FP2092' on the CD, and click **Next**.

This will copy and install the appropriate monitor driver files to your computer.

10. Click **Finish**.

This will close the wizard and return you to the **Monitor Properties** window, now renamed **BenQ FP2091/FP2092 Properties**.

11. Click **Close, OK**, and **OK**.

This will close the **Display Properties** windows. You do not need to restart Windows XP, as the BenQ LCD monitor drivers will operate immediately with no further action required by you.

How to install on Windows 2000, ME, & 98 systems

 You do not need to follow this instruction if you are installing onto a computer which has a **Windows XP (or later) version system**. In that case, see the instructions at [How to install on Windows XP systems](#).

1. Open **Display Properties**.

The quickest shortcut to **Display Properties** is through the Windows desktop.

Right-click the desktop and select **Properties** from the popup menu.

Alternatively, the Windows menu to **Display Properties** is located in **Control Panel**.

In Windows 2000, ME, & 98 versions, **Control Panel** is located under the **Settings** menu item.

Click **Start | Settings | Control Panel | Display**.

The **Display Properties** window will display.

2. Click the **Settings** tab and the **Advanced** button.

The **Advanced Display Properties** window will display.

3. In Windows 2000, click the **Monitor** tab and the **Properties** button.

The **Monitor Properties** window will display.

Alternatively, on Windows ME or 98, click the **Monitor** tab and the **Change** button.

This will jump you directly to the **Upgrade Device Driver Wizard**, skipping the next step.

4. In Windows 2000, click the **Driver** tab and the **Update Driver** button.

The **Upgrade Device Driver Wizard** will display.

See [How to complete the Windows Upgrade Device Driver Wizard](#).

How to complete the Windows Upgrade Device Driver Wizard

1. Load the BenQ LCD Monitor CD-ROM which came with your monitor.
Insert the CD-ROM into a CD drive on the computer you attached the monitor to.
The autorun User's Guide language selection page will display in your web browser.
You can select a language and view the online version of this manual from the next window.
You could then print it out for reference if you wish to work off-line. When you're ready, **Cancel** the browser as it is not required for the Windows **Upgrade Device Driver Wizard**.
2. Launch the Windows **Upgrade Device Driver Wizard** and click **Next**.
For instructions, see [How to install on Windows 2000, ME, & 98 systems](#).
3. Check the option '**Display a list of known drivers ...**' and click **Next**.
4. Click the **Have Disk** button.
The **Install From Disk** window will display.
5. Click the **Browse** button and navigate to the BenQ LCD Monitor CD-ROM.
This is the CD you loaded in step 1 above. The CD Drive will have a Windows designated drive letter (like D: or E: or F:). Select the drive letter corresponding to the drive you put the CD into.
6. Double-click the folder labelled '**Driver**'.
The contents of the 'Driver' folder will display.
7. Click the **Open** button.
This will return you to the **Install from Disk** window, and it will have entered the address to the BenQ LCD Monitor CD 'Driver' folder into the field titled '**Copy manufacturer's files from:**'.
The field will contain something like "D:\Driver", or "E:\Driver", or "F:\Driver".
8. Click the **OK** button.
This will return you to the **Upgrade Device Driver Wizard**.
9. Select (single-click) the file named **BenQ FP2091/FP2092**, and click the **Next** button.
10. Click **Next**.
This will copy the appropriate monitor driver files to your computer.
11. Click **Finish**.
On Windows 2000, this will close the wizard and return you to the **Monitor Properties** window, now renamed '**BenQ FP2091/FP2092 Properties**'.
Alternatively, on Windows ME and 98, this will return you to the **Advanced Display Properties** window, skipping the next step.
Should you wish to do so, this is where you can change the screen refresh rate and other monitor properties to suit your needs. See [How to adjust the screen refresh rate](#) for details.
12. In Windows 2000, click **Close**.
This will close the **BenQ FP2091/FP2092 Properties** window and return you to the **Advanced Display Properties** window.
Should you wish to do so, this is where you can change the screen refresh rate and other monitor properties to suit your needs. See [How to adjust the screen refresh rate](#) for details.
13. In Windows 2000, click **OK**, or in Windows 98 or ME, click **Close**.
This will close the **Advanced Display Properties** window, and return you to the **Display Properties** window.

Should you wish to do so, this is where you can change the screen resolution (area and color). See [How to adjust the screen resolution](#) for details.

14. Click **OK**.

This will close the **Display Properties** window, and if you made any changes to the screen resolution, Windows 2000 will prompt you for confirmation to effect the changes, and further confirmation to accept the changes. Click **OK** and **Yes** respectively.

Alternatively, Windows ME or 98 will ask you if want to make the changes and reboot or not reboot. You should select the reboot option as this causes Windows to load the new drivers when it next restarts.

5 How to adjust the screen resolution

Due to the nature of liquid crystal display (LCD) technology, the picture resolution is always fixed. The best possible picture for your FP2091/FP2092 is achieved with a resolution of 1600x1200. This is called “Native Resolution” or maximal resolution – that is, the clearest picture. Lower resolutions are displayed on a full screen through an interpolation circuit. However flaws do occur with the interpolated resolution.

 **To take full advantage of LCD technology you should select the native resolution setting of 1600x1200.**

1. Open **Display Properties** and select the **Settings** tab.
You can open **Display Properties** by right-clicking on the Windows desktop and selecting **Properties** from the pop-up menu.
2. Use the slider in the ‘Screen area’ section to adjust the screen resolution.
Select the recommended resolution of 1600x1200 then click **Apply**.



If you select some other resolution, be aware that this other resolution is interpolated and may not accurately display the screen image as well as it could do at the native resolution setting.

3. Click **OK** then **Yes**.
4. Close the **Display Properties** window.

6 How to adjust the screen refresh rate

You don't have to choose the highest possible refresh rate on an LCD display, because it is not technically possible for an LCD display to flicker. The best results are obtained by using the factory modes already set in your computer. There is a table with the factory modes in the specification section of this User's Manual.



You can choose 60 Hertz for the native resolution of 1600x1200.

1. Double click the **Display** icon in **Control Panel**.
2. From the **Display Properties** window, select the **Settings** tab and click the **Advanced** button.
3. Select the **Adapter** tab, and select an appropriate refresh rate to match one of the applicable factory modes as listed in the specification table.
4. Click **Change**, **OK**, then **Yes**.
5. Close the **Display Properties** window.

7 How to set the picture optimization

The easiest way to obtain an optimal display is to use the *i*key function. Press the *i*key to optimize and adjust the screen settings automatically for you. Refer to [How to adjust your Monitor](#) for button locations and functionality.

If you wish to, you can always adjust the screen settings manually using the buttons on the monitor panel. To assist you in this endeavour, BenQ has provided a screen test image utility which you can use to check for screen color, grayscale and line gradient display.

1. Run the test program auto.exe from CD-ROM. You could also use any other image, such as the desktop of your operating system. However, we recommend that you use auto.exe. As you run auto.exe, a test pattern displays.
2. Press the **Enter** key to access the monitor On-Screen Display (OSD) menu.
3. If you notice a vertical noise, press the **▲** or **▼** keys to select **Geometry** and press the **Enter** key. Then press the **▲** or **▼** keys to select **Pixel Clock** and press the **Enter** key again. Then, press the **▲** or **▼** key to adjust the monitor until the noise disappears.
4. If you notice a horizontal noise, press the **▲** or **▼** keys to select **Geometry** and press the **Enter** key. Then press the **▲** or **▼** keys to select **Phase** and press the **Enter** key again. Then, press **▲** or **▼** keys to adjust the monitor until the noise disappears.

To make sure the *i*key function performs well, you have to select one of the supported modes. If the *i*key does not work properly and the **NON PRESET MODE** message is on the OSD, it means you are not using one of the supported modes. Please set your monitor to use one of the supported modes as listed at the end of this manual.

8 How to adjust your monitor

A Look at the Control Panel

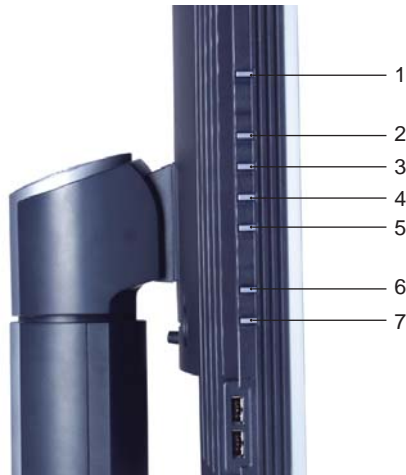

There are 7 keys for user's control including "Enter", "▲", "▼", "Exit", "Input" and "*iKey*" and a power switch. The following descriptions are the introduction of these keys & switch.

1. "Power": Turn the power on or off.
2. "Enter" key: Activate OSD, enter sub menu, select items, confirm selection.
3. ▲ (Up) key: For Up/Increase adjustment. The key is also the hot key for Brightness.
4. ▼ (Down) key: For Down/Decrease adjustment. The key is also the hot key for Contrast.
5. "Exit" key: Back to previous menu or exit OSD.
6. "Input" key: Switch the input signal.
7. "*iKey*": Adjust vertical position, phase, horizontal position and pixel clock automatically.

Hot Key Mode

Brightness and Contrast hot key

Press **▲** to enter Brightness menu, press **▲** or **▼** key to adjust the degree of brightness and press "Exit" to exit OSD.



Press **▼** to enter Contrast menu, press **▲** or **▼** key to adjust the degree of Contrast and press "Exit" to exit OSD.



Input hot key

Press the "Input" key to enter Input menu, and press **▲** or **▼** key to indicate the input source and press "Enter." When done, press "Exit" to exit OSD.



Main Menu Mode

Control Functions Available in Main Menu

Main Menu



Luminance sub menu



Press **▲** or **▼** key to adjust the degree of Brightness, press "Exit" to return to the previous menu.



Press **▲** or **▼** key to adjust the degree of Contrast, press "Exit" to return to the previous menu.

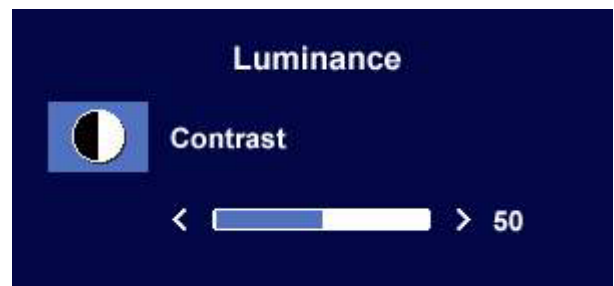

Geometry sub menu

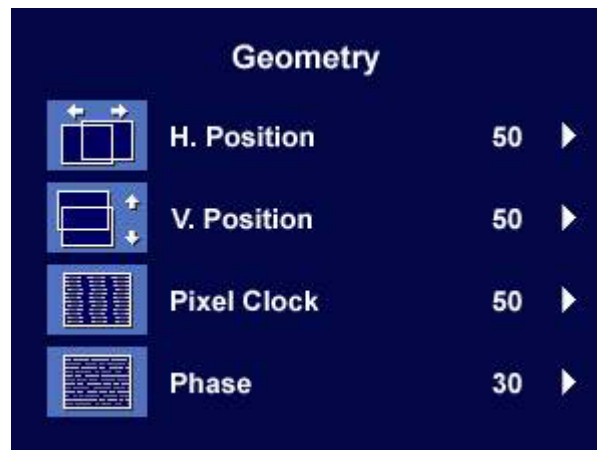

Press \blacktriangle or \blacktriangledown key to adjust the Horizontal Position, press "Exit" to return to previous menu.

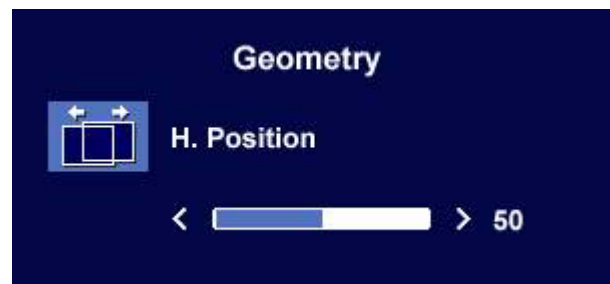

Press \blacktriangle or \blacktriangledown key to adjust the Vertical Position, press "Exit" key to return to previous menu.

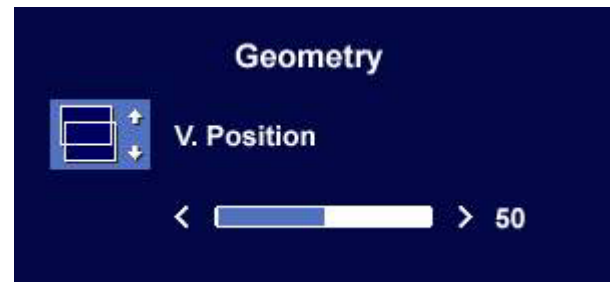

Press \blacktriangle or \blacktriangledown key to adjust the value of the Pixel Clock, press "Exit" to return to previous menu.

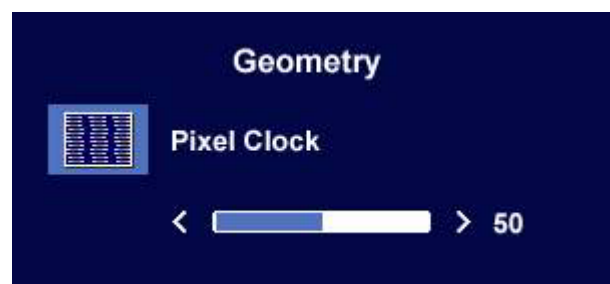

Press \blacktriangle or \blacktriangledown key to adjust the degree of Phase, press "Exit" to return to previous menu.

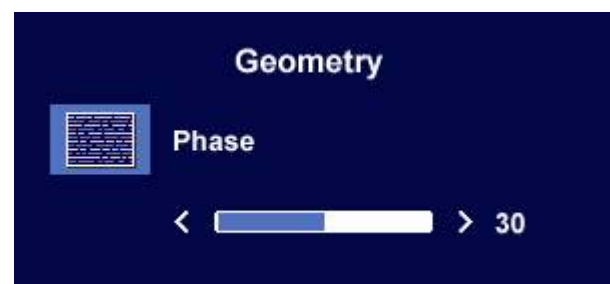

Color sub menu

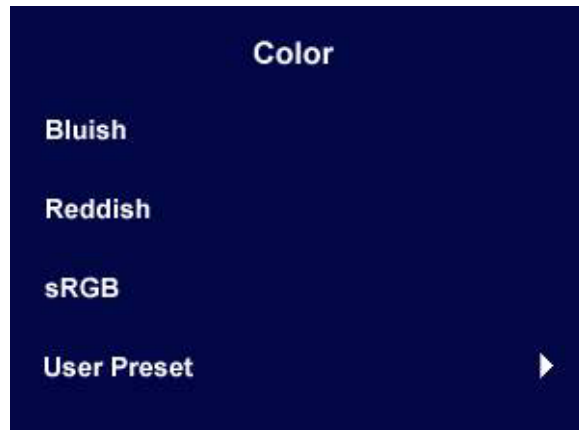

User Preset:

User may set the color balance of Red, Green and Blue.



OSD sub menu

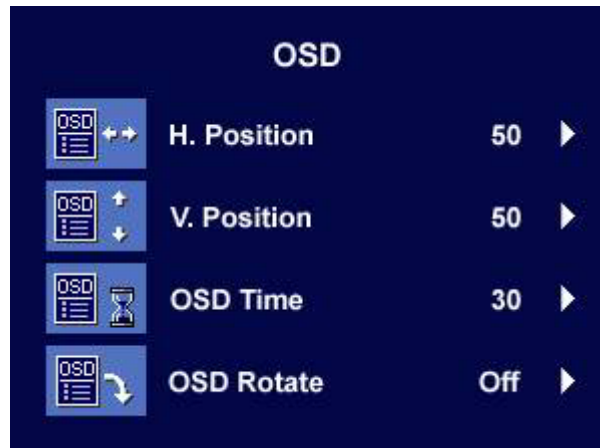

Press \blacktriangle or \blacktriangledown key to adjust the Horizontal Position of the OSD, press "Exit" to return to previous menu.



Press \blacktriangle or \blacktriangledown key to adjust the Vertical Position of the OSD, press "Exit" to return to previous menu.



Press \blacktriangle or \blacktriangledown key to adjust the display time of the OSD, press "Exit" to return to previous menu.



Press \blacktriangle or \blacktriangledown key to determine activation or inactivation of OSD rotate display. When done, press "Enter" to activate the settings. Press "Exit" to return to previous menu.



When the monitor is wall mounted, please make sure that the OSD Rotate function is off.

Languages sub menu



PIP sub menu



Press **▲** or **▼** key to indicate the PIP Source as S-Video or Composite, or choose Off to disable this function. When done, press "Enter" to activate the settings. To return to previous menu, press "Exit."



Press **▲** or **▼** key to specify the PIP Size. When done, press “Enter” to initiate the settings. Press “Exit” to return to previous menu.



Press **▲** or **▼** key to set the PIP Brightness value between 0 and 100. When done, press “Enter” to initiate the settings. Press “Exit” to return to previous menu.



Press **▲** or **▼** key to set the PIP Contrast value between 0 and 100. When done, press “Enter” to initiate the settings. Press “Exit” to return to previous menu.



Press **▲** or **▼** key to adjust the Horizontal Position of PIP. This is a value between 0 and 100. When done, press “Enter” to activate the settings. To return to previous menu, press “Exit.”

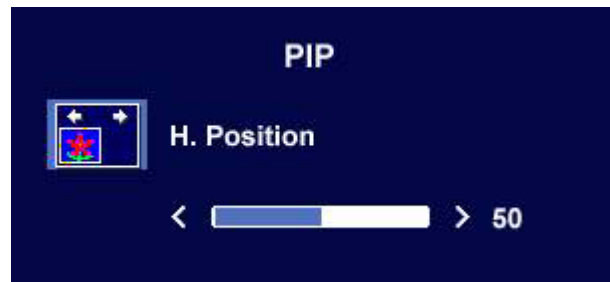

Press **▲** or **▼** key to adjust the Vertical Position of PIP. This is a value between 0 and 100. When done, press “Enter” to activate the settings. To return to previous menu, press “Exit.”

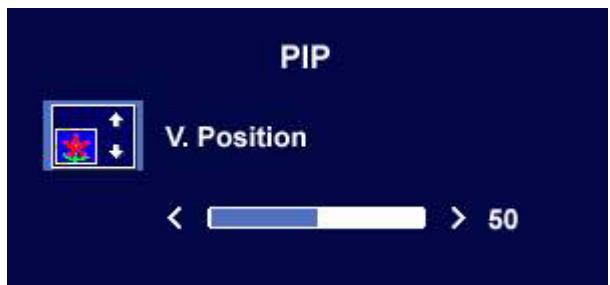

Press **▲** or **▼** key to adjust the value of Hue between 0 and 100. When done, press “Enter” to activate the settings. To return to previous menu, press “Exit.”



Press **▲** or **▼** key to adjust the value of Saturation between 0 and 100. When done, press “Enter” to activate the settings. To return to previous menu, press “Exit.”



Recall sub menu

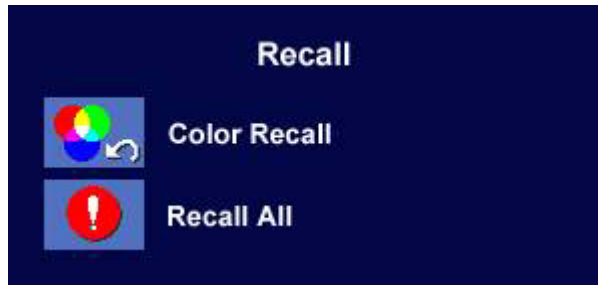

Press **▲** or **▼** key to confirm Color Recall, press “Enter” to recall color settings, or press “Exit” to return to previous menu.



Press **▲** or **▼** key to confirm Recall All, press “Enter” key to recall position and color settings, or press “Exit” key to return to previous menu.



Miscellaneous sub menu

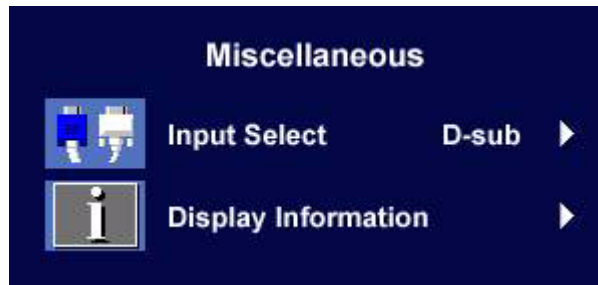

Input Select:

Select D-sub (analog), DVI (digital), S-Video, or Composite input.



Display Information.



9 Troubleshooting

Frequently Asked Questions (FAQ)

? The image is blurred:

☞ Read the [How to adjust the screen resolution](#) section, and then select the correct resolution, refresh rate and make adjustments based on these instructions.

☞ How do you use a VGA extension cable?

Remove the extension cable for the test. Is the image now in focus? If not, optimize the image by working through the instructions in the [How to adjust the screen refresh rate](#) section. It is normal for blurring to occur due to conduction losses in extension cables. You can minimize these losses by using an extension cable with better conduction quality or with a built-in booster.

☞ Does the blurring only occur at resolutions lower than the native (maximum) resolution?

Read the [How to adjust the screen resolution](#) section. Select the native resolution.

? Pixel errors can be seen:

☞ One of several pixels are permanently black, one or more pixels are permanently white, one or more pixels are permanently red, green, blue or another color.

- Clean the LCD screen.
- Cycle power on-off.
- These are pixels that are permanently on or off and is a natural defect that occurs in LCD technology.

? The image has a faulty coloration:

☞ It has a yellow, blue or pink appearance.

On the monitor, press “Enter” key and press ▲ or ▼ key to move to the “Recall” icon and press “Enter” key to enter “Recall” sub menu. Press ▲ or ▼ key to select “Color Recall” and select “Yes” in “Color Recall” sub menu, then press “Enter” key to recall to factory settings. If the image is still not correct and the OSD also has faulty coloration, this means one of the three primary colors is missing in the signal input. Now check the signal cable connectors. If any pin is bent or broken off, please contact your dealer to get necessary support.

? No image can be seen:

☞ Is the prompt on the display illuminated in green?

If the LED is illuminated in green and there is a message “Out of Range” on the screen, this means you are using a display mode that this monitor does not support, please change the setting to one of the supported mode. Please read “[Supported operating modes](#)” section.

☞ Is the prompt on the display illuminated in orange?

If the LED is illuminated in orange, the power management mode is active. Press any button on the computer keyboard or move the mouse. If that does not help, check the signal cable connectors. If any pin is bent or broken off, please contact your dealer to get necessary support.

☞ Is the prompt on the display not illuminated at all?

Check the power supply mains socket, the external power supply and the mains switch.

② The image is distorted, flashes or flickers:

☞ Read the [How to adjust the screen resolution](#) section and then select the correct resolution, refresh rate and make adjustments based on these instructions.

② The image is displaced in one direction:

☞ Read the [How to adjust the screen resolution](#) section and then select the correct resolution, refresh rate and make adjustments based on these instructions.

Need More Help?

If your problems remain after checking this manual, please contact your place of purchase or e-mail us at: Support@BenQ.com

10 Supported operating modes

Incoming display mode (Input timing)					Multi-scan operation
Resolution	Horizontal Frequency (KHz)	Vertical Frequency (Hz)	Pixel Frequency (MHz)	Comment	Actual display resolution
640x350	31.47	70.08	25.17	DOS	full screen 1600x1200
720x400	31.47	70.08	28.32	DOS	
640x480	31.47	60.00	25.18	DOS	
640x480	35.00	67.00	30.24	Macintosh	
640x480	37.86	72.80	31.50	VESA	
640x480	37.50	75.00	31.50	VESA	
800x600	37.88	60.32	40.00	VESA	
800x600	48.08	72.19	50.00	VESA	
800x600	46.87	75.00	49.50	VESA	
832x624	49.72	74.55	57.29	Macintosh	
1024x768	48.36	60.00	65.00	VESA	
1024x768	56.48	70.10	75.00	VESA	
1024x768	60.02	75.00	78.75	VESA	
1024x768	60.24	74.93	80.00	Macintosh	
1152x864	67.50	75.00	108.00	VESA	
1152x870	68.68	75.06	100.00	Macintosh	
1152x900	61.80	66.00	94.50	SUN 66	
1152x900	71.81	76.14	108.00	SUN	
1280x960	60.0	60	108	VESA	
1280x1024	64.00	60.00	108.00	VESA	
1280x1024	75.83	71.53	128.00	IBMI	
1280x1024	80.00	75.00	135.00	VESA	
1280x1024	81.18	76.16	135.09	SPARC2	
1600x1200	75	60	162	VESA	

- Modes not listed in the table may not be supported. For an optimal picture, we recommended you choose a mode listed in the table above.
- There are 24 available modes that are compatible with Windows.
- Image disruption may occur as a result of signal frequency differences from VGA cards which do not correspond with the usual standard. This is not, however, an error. You may improve this situation by altering an automatic setting or by manually changing the phase setting and the pixel frequency from the “Geometry” menu.
- If you switch off the monitor, interference lines can occur on your screen. But do not be concerned about this, as it is normal.
- To extend the service life of the product, we recommend that you use your computer's power management function.

11 Specifications

BenQ FP2091

Model	FP2091
Display type	20.1" , active, TFT
Viewable diagonal	51.05 cm
Native (maximum) resolution	1,600X1,200
Colors	16.7 million
Contrast / Brightness	400:1 / 250 cd/m ²
Response time	16 ms
Viewing angle (left/right, up/down)	88/88, 88/88 (CR=10)
Line frequency	30 - 81 kHz Multi- frequency monitor
Image frequency	50 - 76 Hz modes within these parameters
Image checks	Digital, OSD Technology, <i>iKey</i> (automatic image setting)
Controls	6 buttons and <i>iKey</i> .
Functions	Contrast, brightness, vert. & hor. image position, phase, pixel clock, color balance, color palette, choice of language (8 language OSD), OSD position, status indicator
Power Management	VESA DPMS, EPA
Max. power consumption	90 Watt Max
DC input voltage	20 V
DC input current	4.5 A
Power saving mode	< 5 W
	 This product comply with ENERGY STAR® Program Requirements Computer Monitors. Version 4.0
Input signal	RGB analog 0.7 Vpp/75 Ohm positive Digital: DVI-D Video: S-Video, Composite
Synchronisation	TTL separate signal connection 15-pin mini D-sub cable
Temperature (operating)	5 °C - 40 °C
Air humidity (operating)	20% - 80%

Certifications	TCO 03, TÜV/Ergonomics, TÜV/ GS, FCC Class B, ISO 13406-2, VCCI, UL, CB Report, CE, C-Tick, BSMI, Fimko, GOST
Operating voltage	Automatic switched mode power supply, 90-264 V, 47-63Hz
Dimensions (W x H x D)	461.2 x 445.2 x 242.6 mm
Weight	8.6 kg

Model	FP2092
Display type	20.1" , active, TFT
Viewable diagonal	51.05 cm
Native (maximum) resolution	1,600X1,200
Colors	16.7 million
Contrast / Brightness	700:1 / 300 cd/m ²
Response time	16 ms 12 ms (GTG)
Viewing angle (left/right, up/down)	88/88, 88/88 (CR=10)
Line frequency	30 - 81 kHz Multi- frequency monitor
Image frequency	50 - 76 Hz modes within these parameters
Image checks	Digital, OSD Technology, <i>iKey</i> (automatic image setting)
Controls	6 buttons and <i>iKey</i> .
Functions	Contrast, brightness, vert. & hor. image position, phase, pixel clock, color balance, color palette, choice of language (8 language OSD), OSD position, status indicator
Power Management	VESA DPMS, EPA
Max. power consumption	90 Watt Max
DC input voltage	20 V
DC input current	4.5 A
Power saving mode	< 5 W
Input signal	RGB analog 0.7 Vpp/75 Ohm positive Digital: DVI-D Video: S-Video, Composite
Synchronisation	TTL separate signal connection 15-pin mini D-sub cable
Temperature (operating)	5 °C - 40 °C
Air humidity (operating)	20% - 80%
Certifications	TCO 99, TÜV/Ergonomics, TÜV/ GS, FCC Class B, ISO 13406-2, VCCI, UL, CB Report, CE, C-Tick, BSMI, Fimko, GOST
Operating voltage	Automatic switched mode power supply, 90-264 V, 47-63Hz
Dimensions (W x H x D)	461.2 x 445.2 x 242.6 mm
Weight	8.6 kg