

ATLAS INDUSTRIAL FLAT PANEL PC MONITOR

QUICK INSTALLATION GUIDE - ATM1700/ATM1700T



ATM1700/ATM1700T



NOTE: SEE THE HARDWARE USER'S GUIDE, ATM-17-USER, INCLUDED ON THE SUPPLIED DOCUMENTATION & DRIVER CD FOR ADDITIONAL DETAILS. THE USER'S GUIDE IS IN PDF FILE FORMAT AND REQUIRES DOWNLOADING ADOBE'S FREE ADOBE READER TO OPEN AND VIEW.

1. Verify Contents of the Box:

- Atlas Flat Panel Monitor – ATM1700 or ATM1700T (The “T” at the end of the part number designates the touch screen option.)
- VGA video cable – 6' length
- RS-232 Serial touch screen cable (ATM1700T only) – 6' length
- USB touch screen cable (ATM1700T only) – 2m length
- Mounting clips and screws (qty of 14)
- USB retention bracket and mounting screw (ATM1700T only)
- Documentation and Driver CD

Contents:

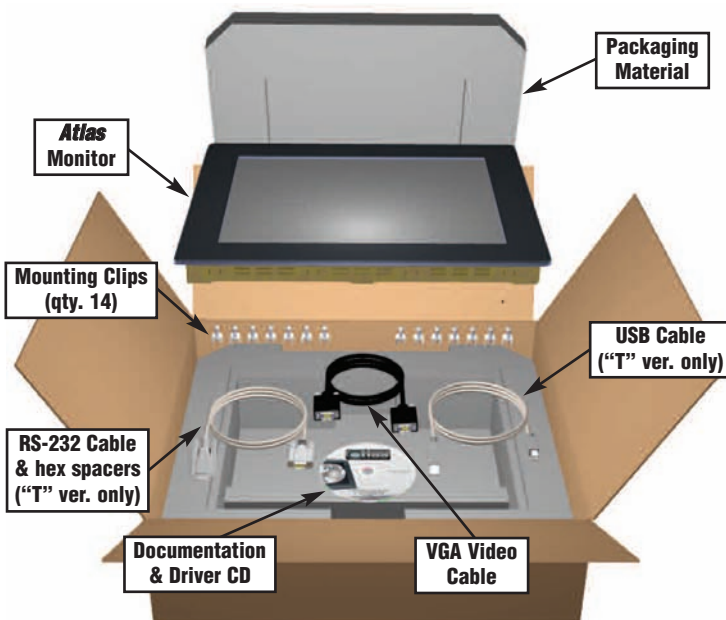

Description:

The Atlas ATM1700/ATM1700T is a high performance 17" color TFT flat panel monitor specifically designed for harsh industrial environments including Class I & II, Division 2 Hazardous Locations. The ATM1700/ATM1700T accepts standard analog VGA input or digital DVI input, and can display all VESA video modes up to 1280 x 1024 at 75 Hz with 16 million colors. An optional 5-wire analog touch screen (ATM1700T) is available that offers both RS-232 and USB interface capability. The monitor is housed in a heavy duty steel chassis with a powder coated machined aluminum bezel. The monitor is certified to NEMA 4/4X/12 standards, is UL/CUL listed, meets CE requirements and is RoHS compliant. Panel mounting is simplified using convenient mounting clips instead of conventional studs. All monitors are shipped with a power input wiring receptacle, 6' VGA cable, 6' RS-232 cable (ATM1700T only), 2m USB Cable (ATM1700T only), mounting hardware, this Quick Installation Guide, and CD-ROM containing Hardware User's Guide (ATM-17-USER) and touch screen driver software for Windows 98/NT/2000/XP/Vista.

Dimensions:

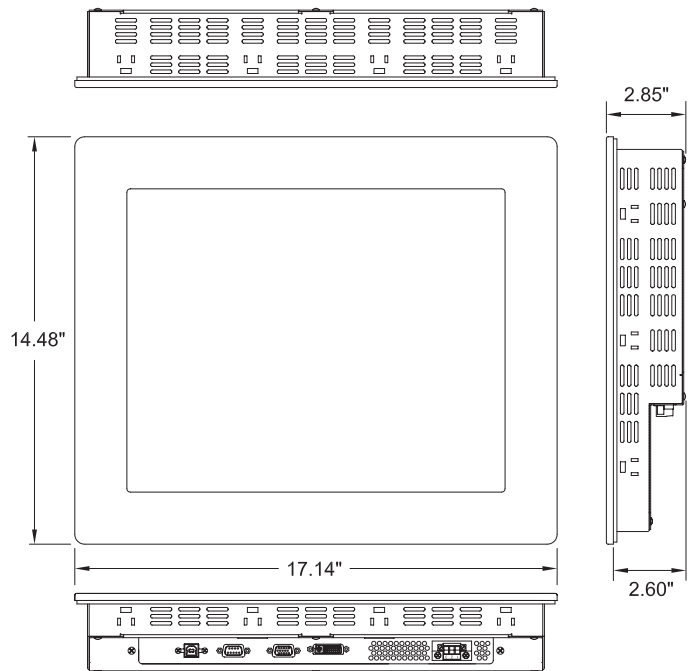

Agency Approvals:

Certifications & Standards			
Name	UL508	UL1604	CE
Atlas Flat Panel Monitor	E191072	E313546	EN 55022-1: Class A, EN 61000-3-2: Class A, EN 61000-3-3, EN 61000-6-2, IEC 60950-1



2. Install Monitor through Enclosure Door or Wall

- Use dimensions as shown in the diagram below to provide a rectangular mounting cutout in an approved NEMA 4/12 enclosure's door or wall.
- Mount the monitor through the enclosure cutout, install and tighten (14) mounting clips to a torque of 8.0 inch-pounds as shown in the diagram to the right.

Cutout Dimensions:

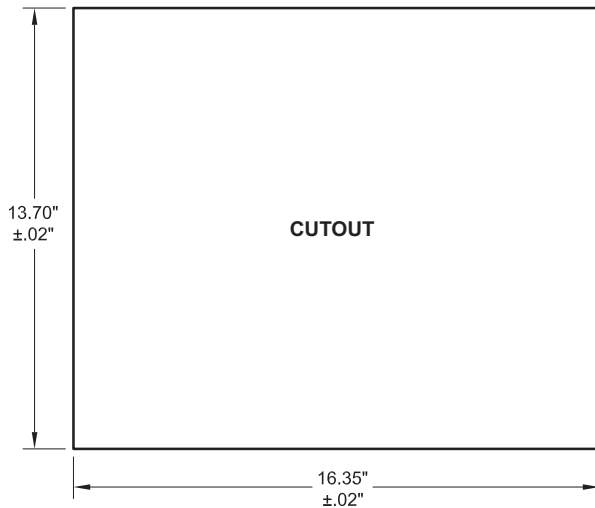

WARNING: An operating temperature of 0 to 50 °C (32 to 122 °F) needs to be maintained for proper operation of the monitor.

3. Connect DVI or VGA Video Cable between Monitor & PC

- Connect the included 6' VGA video cable from the video connector on the monitor to the video output connector on the host PC being used with the monitor or use a digital DVI-M cable (sold separately).
- If using a DVI-D cable, then special instructions apply when applying power; see warning to the right in regards to selecting the video input.



NOTE: THE 17" MONITOR WILL PRODUCE THE BEST IMAGE QUALITY IF THE PC IS SET FOR A 1280 X 1024 PIXELS @ EITHER 60, OR 75 HZ. VIDEO MODE.

4. Connect USB or Serial Cable between Monitor & PC

- Applies to ATM1700T touch screen version only.
- Use either the included 6' RS-232 Serial touch screen cable or the 2m USB touch screen cable from the appropriate connector on the monitor to the appropriate connector on the host computer; do not connect both.
- If using the USB cable, secure the cable using the included USB retention bracket and screw; consult the Hardware User's Guide, ATM-17-USER, on the supplied Documentation and Drive CD for details.



WARNING

To minimize the risk of potential safety problems, you should follow all applicable local and national codes that regulate the installation and operation of your equipment. These codes vary from area to area and it is your responsibility to determine which codes should be followed, and to verify that the equipment, installation, and operation are in compliance with the latest revision of these codes.

Equipment damage or serious injury to personnel can result from the failure to follow all applicable codes and standards. We do not guarantee the products described in this publication are suitable for your particular application, nor do we assume any responsibility for your product design, installation, or operation.

If you have any questions concerning the installation or operation of this equipment, or if you need additional information, please call Technical Support at 770-844-4200.

This publication is based on information that was available at the time it was printed. At Automationdirect.com® we constantly strive to improve our products and services, so we reserve the right to make changes to the products and/or publications at any time without notice and without obligation. This publication may also discuss features that may not be available in certain revisions of the product.

Mounting Clip Installation:

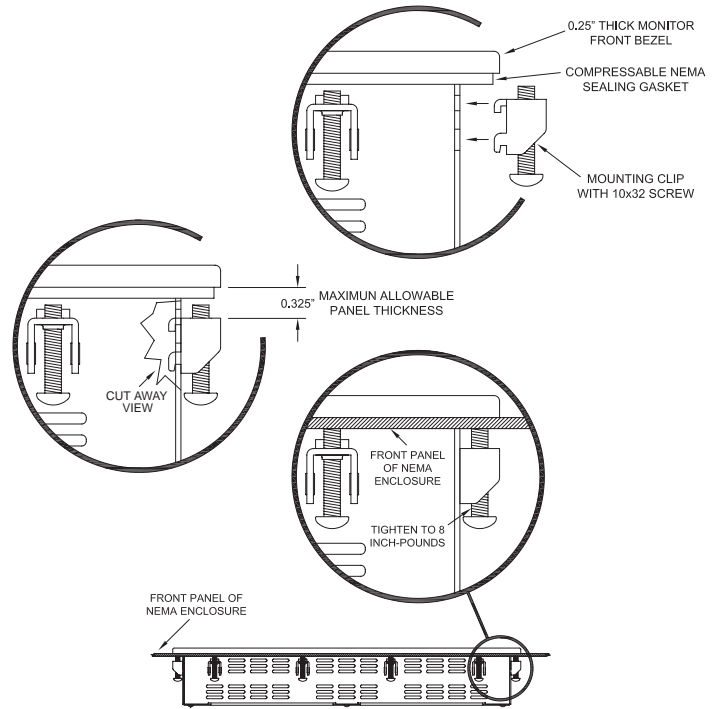

WARNING: Damage can occur by applying excessive torque to the mounting clips.

Cable Connections:

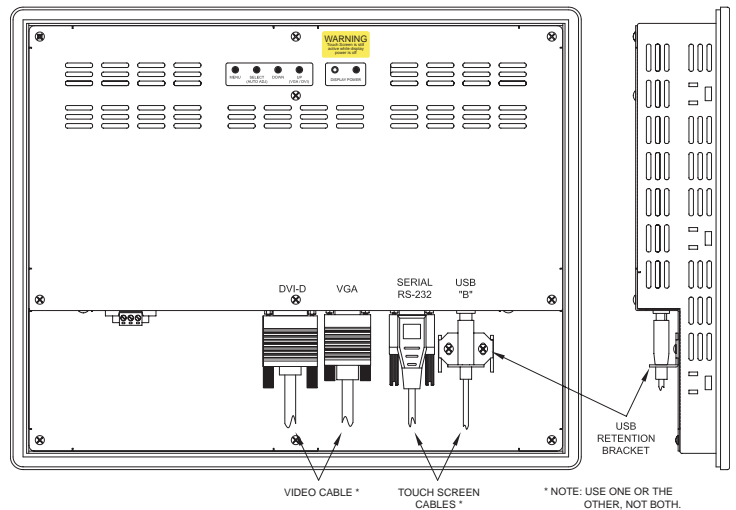

5. Connect Power to the Monitor

- Power source needs to be 100 - 240 VAC, 50/60 Hz, ≥30 Watts.
- See connection diagram below.
- Secure power connector screws to monitor.
- Power should not be applied until all cables are attached and the monitor is ready to operate.



WARNING: Damage can occur if power is not properly connected.

6. Apply Power to the Monitor & PC

- Press the DISPLAY POWER button on the rear of the monitor to wake the monitor up. Pressing the DISPLAY POWER button again turns off the backlight inverter and puts the monitor in a reduced power state but the touch screen remains active. It is important to note that this switch does not disconnect power from the monitor. Power is always supplied to the internal AC/DC power supply, which in turn continually supplies power to the internal monitor electronics and the optional touch screen controller.

7. Install the Appropriate Touch Screen Driver

- Applies to ATM1700T touch screen version only.
- Insert the Documentation and Driver CD into the host PC's CD drive.
- If the CD does not start automatically with the window shown below displayed, then go to Start > Run, browse to the CD's "atlas.exe" file, open it, and click OK.
- From the Atlas screen, the user can view the Hardware User's Guide for the monitor being used, and/or install the touch screen drivers for the particular PC operating system being used. Before installing the drivers, please read the Touch Screen Driver Documentation for operating system details.
- Reboot the PC and restart the monitor to activate the driver.

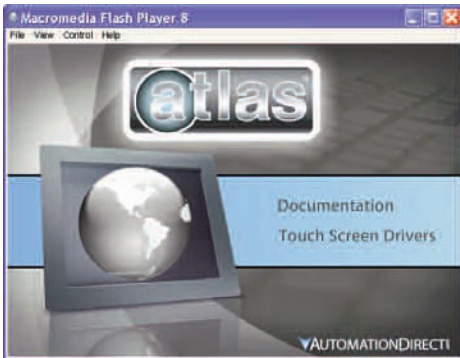

8. Verify Video and Touch Screen Functionality

- Verify the monitor's video display by running a familiar program.
- If using the touch screen model (ATM1700T), use the touch screen to navigate by running a familiar program.

9. Adjust the Monitor OSD Settings as Required

- Press the Select (Auto Adj) control button on the rear of the panel to initiate an automatic configuration of the screen.
- Although normally not needed, the control buttons on the rear of panel can be used to make other adjustments to the screen.
- Consult the Hardware User's Guide, ATM-17-USER, on the supplied Documentation and Drive CD for detailed usage of the OSD settings.

10. Installation Complete

Power Connections:

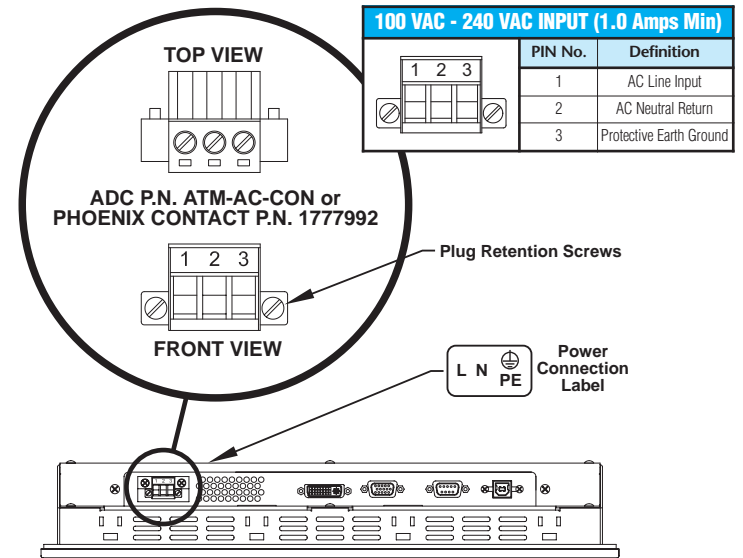

LCD Power Button:

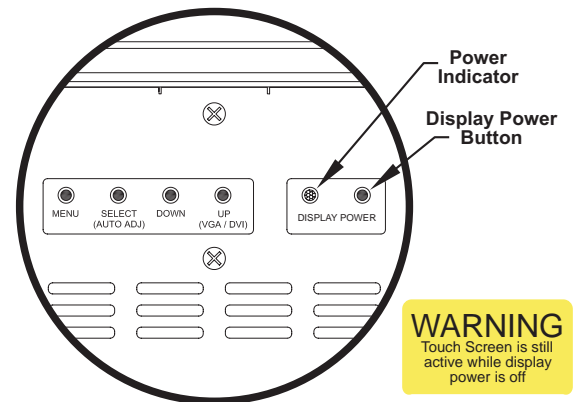

WARNING: The monitor does not automatically select a video input mode. The user must press the "UP (VGA/DVI)" button on the rear of the monitor to select either VGA or DVI input. If a "No Video" message appears on the screen, it is also suggested the user try using the "UP (VGA/DVI)" button to select the active video input.



NOTE: ONCE YOU HAVE CONNECTED YOUR PC AND THE MONITOR, SELECTED THE VIDEO SOURCE, AND POWERED BOTH UNITS, IT IS SUGGESTED THAT THE "SELECT (AUTO ADJ)" BUTTON ON THE REAR OF THE MONITOR BE PRESSED TO MAXIMIZE THE VIDEO SETTINGS.

OSD Settings Main Menu:



Additional Help and Support

- For product support, specifications, installation, and troubleshooting, a Hardware User's Guide, ATM-17-USER, is included on the supplied Documentation and Driver CD, or downloadable from the Online Documentation area of the **AutomationDirect** Web site.
- For additional technical support and questions, call our Technical Support team @ 770-844-4200.



Accessories & Replacement Parts:

Part Number	Description
ATM-CBL-VGA10	10 ft. 15-pin coaxial VGA cable. Connects any Atlas monitor to a standard VGA card.
ATM-CBL-VGA25	25 ft. 15-pin coaxial VGA cable. Connects any Atlas monitor to a standard VGA card.
ATM-CBL-VGA50	50 ft. 15-pin coaxial VGA cable. Connects any Atlas monitor to a standard VGA card.
ATM-CBL-DV2M	6 ft. (2 meter) DVI (type D) video cable. Connects M1700 and M1900 to a standard DVI-D port. DVI cables provide a higher bandwidth video interface than the VGA cables.
ATM-CBL-DV3M	10 ft. (3 meter) DVI (type D) video cable. Connects M1700 and M1900 to a standard DVI-D port. DVI cables provide a higher bandwidth video interface than the VGA cables.
ATM-CBL-10	10 ft. serial communication cable. Connects Atlas monitor to std. 9-pin RS-232 port.
ATM-CBL-25	25 ft. serial communication cable. Connects Atlas monitor to std. 9-pin RS-232 port.
ATM-CBL-50	50 ft. serial communication cable. Connects Atlas monitor to std. 9-pin RS-232 port.
USB-CBL-AB3	3-ft (0.9 meter) Standard USB 2.0 cable with Standard-A plug to Standard-B plug. Suitable for all USB devices.
USB-CBL-AB6	6-ft (1.8 meter) Standard USB 2.0 cable with Standard-A plug to Standard-B plug. Suitable for all USB devices.
USB-CBL-AB10	10-ft (3 meter) Standard USB 2.0 cable with Standard-A plug to Standard-B plug. Suitable for all USB devices.
USB-CBL-AB15	15-ft (4.6 meter) Standard USB 2.0 cable with Standard-A plug to Standard-B plug. Suitable for all USB devices.
ATM-AC-CON	Replacement Power Wiring Connector for AC Powered Units.
ATM-CLIP	Replacement flat panel mounting clip kit. Package of 16 clips and screws.



ATM-CBL-10



ATM-CBL-25



ATM-CBL-50



USB-CBL-AB3



USB-CBL-AB6



USB-CBL-AB10



USB-CBL-AB15



ATM-AC-CON



ATM-CLIP



ATM-CBL-VGA10



ATM-CBL-VGA25



ATM-CBL-VGA50



ATM-CBL-DV2M



ATM-CBL-DV3M

Quick Installation Guide: ATM-17-QIG, Rev. B



A T M - 1 7 - Q I G