

ASUS[®]

**MB19 Series/
MB17 Series
LCD Monitor**

User Guide

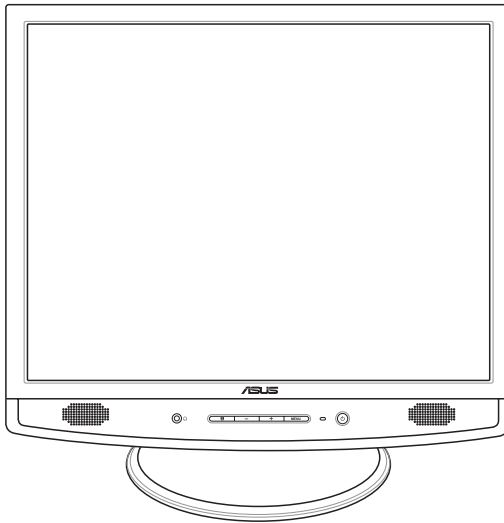

E2624

First Edition V1

May 2006

Copyright © 2006 ASUSTeK COMPUTER INC. All Rights Reserved.

No part of this manual, including the products and software described in it, may be reproduced, transmitted, transcribed, stored in a retrieval system, or translated into any language in any form or by any means, except documentation kept by the purchaser for backup purposes, without the express written permission of ASUSTeK COMPUTER INC. ("ASUS").

Product warranty or service will not be extended if: (1) the product is repaired, modified or altered, unless such repair, modification or alteration is authorized in writing by ASUS; or (2) the serial number of the product is defaced or missing.

ASUS PROVIDES THIS MANUAL "AS IS" WITHOUT WARRANTY OF ANY KIND, EITHER EXPRESS OR IMPLIED, INCLUDING BUT NOT LIMITED TO THE IMPLIED WARRANTIES OR CONDITIONS OF MERCHANTABILITY OR FITNESS FOR A PARTICULAR PURPOSE. IN NO EVENT SHALL ASUS, ITS DIRECTORS, OFFICERS, EMPLOYEES OR AGENTS BE LIABLE FOR ANY INDIRECT, SPECIAL, INCIDENTAL, OR CONSEQUENTIAL DAMAGES (INCLUDING DAMAGES FOR LOSS OF PROFITS, LOSS OF BUSINESS, LOSS OF USE OR DATA, INTERRUPTION OF BUSINESS AND THE LIKE), EVEN IF ASUS HAS BEEN ADVISED OF THE POSSIBILITY OF SUCH DAMAGES ARISING FROM ANY DEFECT OR ERROR IN THIS MANUAL OR PRODUCT.

SPECIFICATIONS AND INFORMATION CONTAINED IN THIS MANUAL ARE FURNISHED FOR INFORMATIONAL USE ONLY, AND ARE SUBJECT TO CHANGE AT ANY TIME WITHOUT NOTICE, AND SHOULD NOT BE CONSTRUED AS A COMMITMENT BY ASUS. ASUS ASSUMES NO RESPONSIBILITY OR LIABILITY FOR ANY ERRORS OR INACCURACIES THAT MAY APPEAR IN THIS MANUAL, INCLUDING THE PRODUCTS AND SOFTWARE DESCRIBED IN IT.

Products and corporate names appearing in this manual may or may not be registered trademarks or copyrights of their respective companies, and are used only for identification or explanation and to the owners' benefit, without intent to infringe.

Table of contents

Notices	iv
Safety information	v
Care & Cleaning	vi
Package contents.....	viii
Chapter 1: Product introduction	
1.1 Features.....	1-2
1.2 Assembling the monitor base.....	1-2
1.3 Monitor introduction	1-3
Front of the LCD monitor	1-3
Rear of the LCD monitor	1-5
Chapter 2: Setup	
2.1 Connecting the cables	2-2
2.2 Turning the monitor on.....	2-3
2.3 Adjusting the monitor.....	2-3
Chapter 3 General Instruction	
3.1 OSD (On-Screen Display) menu	3-2
3.2 Troubleshooting (FAQ).....	3-4
3.3 Specification summary.....	3-5
3.4 Supported operating modes	3-11

Notices

Federal Communications Commission Statement

This device complies with Part 15 of the FCC Rules. Operation is subject to the following two conditions:

- This device may not cause harmful interference, and
- This device must accept any interference received including interference that may cause undesired operation.

This equipment has been tested and found to comply with the limits for a Class B digital device, pursuant to Part 15 of the FCC Rules. These limits are designed to provide reasonable protection against harmful interference in a residential installation. This equipment generates, uses and can radiate radio frequency energy and, if not installed and used in accordance with manufacturer's instructions, may cause harmful interference to radio communications. However, there is no guarantee that interference will not occur in a particular installation. If this equipment does cause harmful interference to radio or television reception, which can be determined by turning the equipment off and on, the user is encouraged to try to correct the interference by one or more of the following measures:

- Reorient or relocate the receiving antenna.
- Increase the separation between the equipment and receiver.
- Connect the equipment to an outlet on a circuit different from that to which the receiver is connected.
- Consult the dealer or an experienced radio/TV technician for help.

As an Energy Star® Partner, our company has determined that this product meets the Energy Star® guidelines for energy efficiency.

Canadian Department of Communications Statement

This digital apparatus does not exceed the Class B limits for radio noise emissions from digital apparatus set out in the Radio Interference Regulations of the Canadian Department of Communications.

This class B digital apparatus complies with Canadian ICES-003.

Safety information

- Before setting up the monitor, carefully read all the documentation that came with the package.
- To prevent fire or shock hazard, never expose the monitor to rain or moisture.
- Never try to open the monitor cabinet. The dangerous high voltages inside the monitor may result in serious physical injury.
- If the power supply is broken, do not try to fix it by yourself. Contact a qualified service technician or your retailer.
- Before using the product, make sure all cables are correctly connected and the power cables are not damaged. If you detect any damage, contact your dealer immediately.
- Slots and openings on the back or top of the cabinet are provided for ventilation. Do not block these slots. Never place this product near or over a radiator or heat source unless proper ventilation is provided.
- The monitor should be operated only from the type of power source indicated on the label. If you are not sure of the type of power supply to your home, consult your dealer or local power company.
- Use the appropriate power plug which complies with your local power standard.
- Do not overload power strips and extension cords. Overloading can result in fire or electric shock.
- Avoid dust, humidity, and temperature extremes. Do not place the monitor in any area where it may become wet. Place the monitor on a stable surface.
- Unplug the unit during a lightning storm or if it will not be used for a long period of time. This will protect the monitor from damage due to power surges.
- Never push objects or spill liquid of any kind into the slots on the monitor cabinet.
- To ensure satisfactory operation, use the monitor only with UL listed computers which have appropriate configured receptacles marked between 100-240V AC.
- If you encounter technical problems with the monitor, contact a qualified service technician or your retailer.

Care & Cleaning

- Before you lift or reposition your monitor, it is better to disconnect the cables and power cord. Follow the correct lifting techniques when positioning the monitor. When lifting or carrying the monitor, grasp the edges of the monitor. Do not lift the display by the stand or the cord.
- Cleaning. Turn your monitor off and unplug the power cord. Clean the monitor surface with a lint-free, non-abrasive cloth. Stubborn stains may be removed with a cloth dampened with mild cleaner.
- Avoid using a cleaner containing alcohol or acetone. Use a cleaner intended for use with the LCD. Never spray cleaner directly on the screen, as it may drip inside the monitor and cause an electric shock.

The following symptoms are normal with the monitor:

- The screen may flicker during the initial use due to the nature of the fluorescent light. Turn off the Power Switch and turn it on again to make sure that the flicker disappears.
- You may find slightly uneven brightness on the screen depending on the desktop pattern you use.
- When the same image is displayed for hours, an afterimage of the previous screen may remain after switching the image. The screen will recover slowly or you can turn off the Power Switch for hours.
- When the screen becomes black or flashes, or cannot work anymore, contact your dealer or service center to fix it. Do not repair the screen by yourself!

Conventions used in this guide



WARNING: Information to prevent injury to yourself when trying to complete a task.



CAUTION: Information to prevent damage to the components when trying to complete a task.



IMPORTANT: Information that you **MUST** follow to complete a task.



NOTE: Tips and additional information to aid in completing a task.

Where to find more information

Refer to the following sources for additional information and for product and software updates.

1. ASUS websites

The ASUS websites worldwide provide updated information on ASUS hardware and software products. Refer to <http://www.asus.com>

2. Optional documentation

Your product package may include optional documentation, such as warranty card, that may have been added by your dealer. These documents are not part of the standard package.

Package contents

Check your MB19/MB17 Series LCD package for the following items:

- ✓ LCD monitor
- ✓ Quick Start Guide
- ✓ Support CD
- ✓ 1 x Power cord
- ✓ 1 x VGA cable
- ✓ 1 x DVI cable (MB19TU only)
- ✓ 1 x Audio cable
- ✓ 1 x Cable holder



If any of the above items is damaged or missing, contact your retailer immediately.

Chapter 1

This chapter gives a general description of the ASUS LCD monitor MB19/MB17 Series. The chapter lists the monitor features including introduction on the front and rear panels.

Product introduction

1.1 Features

- 19"/17" LCD Monitor
- Recommended resolution: 1280 X 1024
- MB19TU: 2ms (Gray to Gray) Rapid response time
MB19SE/MB17SE: 5ms (Tr+Tf) Quick response time
- SPLENDID™ Video Enhancement Technology
- 5 Video preset modes switched by hotkey
- 3 Skin-tones selection
- Microsoft Windows® 2000/XP compliance
- VESA Display Data Channel DDC2B compliance
- VESA wall mount compliance (100x100mm)
- EPA ENERGY STAR® and ergonomic design
- Both VGA and DVI-D Inputs (MB19TU only)
- 2W x 2 Stereo speakers and earphone output
- RoHS compliance

1.2 Assembling the monitor base

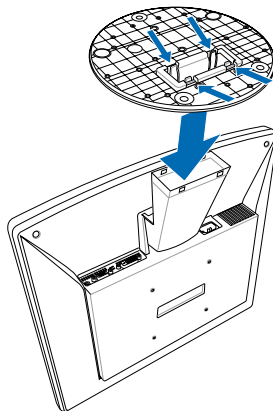

1.3 Monitor introduction

Front of the LCD monitor

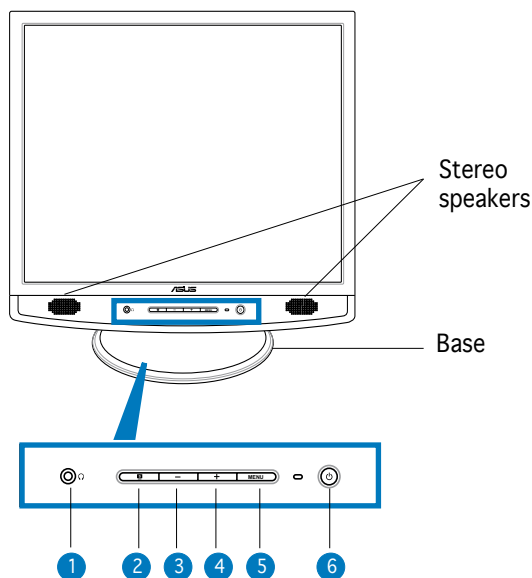

1. Headphone port (🔊). This port connects a headphone with a stereo mini-plug (3.5mm).
2. “S” Button:
 - Use this hotkey to switch from five video preset modes (Game Mode, Night View Mode, Scenery Mode, Standard Mode, Theater Mode) with SPLENDID™ Video Enhancement Technology.
 - Exit the OSD menu or go back to the previous menu as the OSD menu is active.
 - Automatically adjust the image to its optimized position, clock, and phase by pressing the button for 2-4 seconds.
3. “-” Button:
 - Press this button to decrease the value of the function selected or move to the previous function.
 - This is also a hotkey for Volume adjustment.

4. “+” Button:
 - Press this button to increase the value of the function selected or move to the next function.
 - This is also a hotkey for Brightness adjustment.
5. MENU Button:
 - Press this button to enter/select the icon (function) highlighted while the OSD menu is activated.
6.  Power Button
 - Press this button to turn the monitor on/off.
 - The table below shows the status of the LED indicator beside this button.

Status	Description
Blue	ON
Amber	Standby mode
OFF	OFF



The headphone is purchased separately.

Rear of the LCD monitor

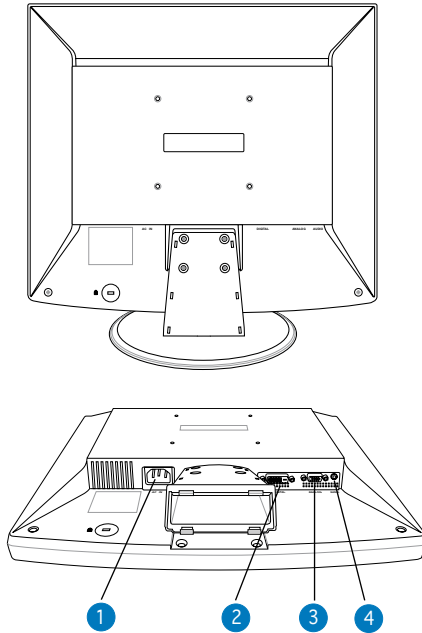

1. AC-in port. This port connects the power connector by the bundled power cord.
2. DVI port. (MB19TU only) This 24-pin port is for PC (Personal Computer) DVI-D digital signal connection.
3. VGA port. This 15-pin port is for PC VGA connection.
4. Audio-in port. This port connects PC audio source by the bundled audio cable .

Chapter 2

This chapter provides instructions on how to correctly connect cables and properly adjust the angle of the LCD monitor.

2.1 Connecting the cables

1. Connect the cables as shown:

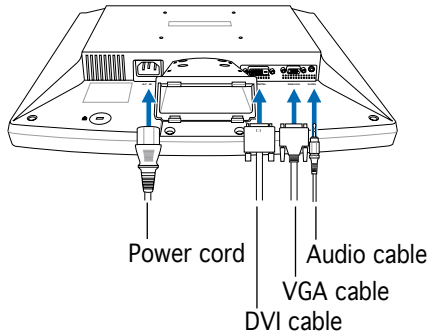

- To connect the audio cable: connect one end of the audio cable to the monitor's Audio-in port, and then connect the other end to the computer multi-media (or audio) card's audio output.
 - To connect the power cord: connect one end of the power cord securely to the monitor's AC input port, the other end to a power outlet.
 - To connect the VGA/DVI cable:
 - a. Plug the VGA/DVI connector to the LCD monitor's VGA/DVI port.
 - b. Connect the other end of the VGA/DVI cable to your computer's VGA/DVI port.
 - c. Tighten the two screws to secure the VGA/DVI connector.
2. Gather all the cables, then hold them with the cable holder. Align the cable holder to the two slots near the base and close it carefully. A click indicates that the cable holder has been closed securely.

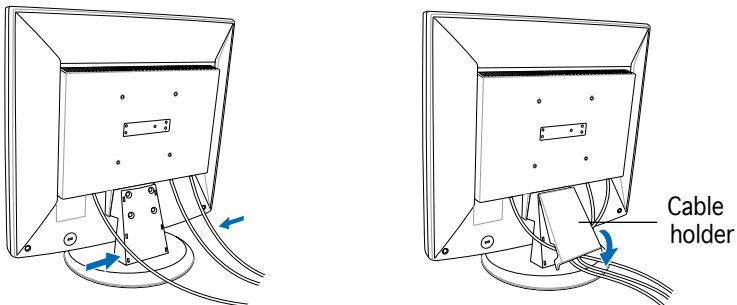

2.2 Turning the monitor on

Press the power button . See page 1-4 for the location of the power button. The power indicator beside the power button lights up in blue to show that the monitor is ON.

2.3 Adjusting the monitor

You can adjust the monitor as shown below.

- For optimal viewing, we recommend that you look at the full face of the monitor, then adjust the monitor to the angle that is most comfortable for you.
- Hold the stand to prevent the monitor from falling when you change its angle.
- You can adjust the monitor's angle from -5° to 20° .

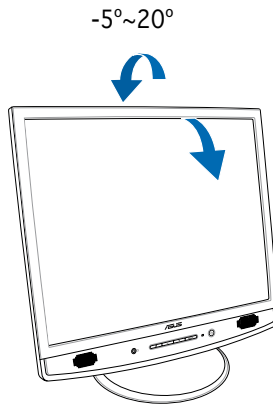

Chapter 3

This chapter introduces the operating instruction, including how to use the OSD (On-Screen Display) menu.

General Instruction

3.1 OSD (On-Screen Display) menu

OSD MENU TABLE

The table describes the function of each OSD icon.









































Main Menu Item	Main Menu Icon	Sub Menu Item	Sub Menu Icon	Description
Splendid		Scenery Mode		Advance for scenery use with SPLENDID™ Video Enhancement
		Standard Mode		Advance for general Windows use (SPLENDID™ Off)
		Theater Mode		Advance for movie use with SPLENDID™ Video Enhancement
		Game Mode		Advance for game use with SPLENDID™ Video Enhancement
		Night Mode		Advance for dark-display use with SPLENDID™ Video Enhancement
Color Adjust		RGB		Color R Adjust red gain
				Color G Adjust green gain
				Color B Adjust blue gain
		Skin Tone		Reddish Select reddish skin stone
				Natural Select natural skin stone
				Yellowish Select yellowish skin stone
		Color Temp		Cool The image appears bluer. (9300°K)
				Normal Normal image color. (7500°K)
				Warm The image appears redder. (6500°K)
Luminance		Brightness		Adjust brightness level
		Contrast		Adjust contrast level
OSD Setup		OSD H-Position		Adjust horizontal position of the OSD
		OSD V-Position		Adjust vertical position of the OSD
		OSD Timeout		Adjust OSD timeout

Image Setup		Focus		Phase		Adjust image Phase to reduce Horizontal-line noise of the image
				Clock		Adjust image Clock to reduce Vertical-line noise of the image
		Image Position		H-Position		Adjust horizontal position of the image
				V-Position		Adjust vertical position of the image
		Auto		Automatically adjust the horizontal /vertical positions, phase and clock of the image		
Input Select		Select an input signal from analog/digital source (TU SKU only)				
Information		Show the resolution,H/V frequency and input port of current input timing				
Language		Select the desired language				
Reset		Recall default setting				
Exit		Exit OSD				

3.2 Troubleshooting (FAQ)

Problem	Possible Solution
Power LED is not ON	<ul style="list-style-type: none"> • Press the  button to check if the monitor is in the ON mode. • Check if the power cord is properly connected to the monitor and the power outlet.
The Power LED lights amber and there is no screen image	<ul style="list-style-type: none"> • Check if the monitor and the computer are in the ON mode. • Make sure the signal cable is properly connected the monitor and the computer. • Inspect the signal cable and make sure none of the pins are bent. • Connect the computer with another available monitor to check if the computer is properly working.
Screen image is too light or dark	<ul style="list-style-type: none"> • Adjust the Contrast and Brightness settings via OSD.
Screen image is not centered or sized properly	<ul style="list-style-type: none"> • Press the  button for two seconds to automatically adjust the image. • Adjust the H-Position or V-Position settings via OSD.
Screen image bounces or a wave pattern is present in the image	<ul style="list-style-type: none"> • Make sure the signal cable is properly connected to the monitor and the computer. • Move electrical devices that may cause electrical interference.
Screen image has color defects (white does not look white)	<ul style="list-style-type: none"> • Inspect the signal cable and make sure that none of the pins are bent. • Perform Reset via OSD. • Adjust the R/G/B color settings or select the Color Temperature via OSD.
Screen image is blurry or fuzzy	<ul style="list-style-type: none"> • Press the  button for two seconds to automatically adjust the image. • Adjust the Phase and Clock settings via OSD.
No sound or sound is low	<ul style="list-style-type: none"> • Ensure that the audio cable is properly connected to the monitor and the computer • Adjust the volume settings of both your monitor and computer. • Ensure that the computer sound card driver is properly installed and activated.

3.3 Specification summary (MB19SE)

Panel Type	TFT LCD
Panel size	19.0" Standard screen
Max. Resolution	SXGA 1280 x 1024
Pixel pitch	0.294mm
Brightness (Typ.)	300cd/m ²
Contrast Ratio (Typ.)	700:1
Viewing angle(H/V)	160°/160°
Display colors	16.2M
Response time	5ms (Tr+Tf)
SPLENDID™ Video Intelligence Technology	Yes
Splendid selection	5 Video Preset Modes (by  hotkey)
Auto adjustment	Yes (by  hotkey)
Color temperature selection	3 modes (9300°K/7500°K/6500°K)
Skin-Tone selection	3 modes
DVI port	--
VGA port	15-Pin D-Sub
Audio-in port	3.5mm Mini-jack
Headphone port	3.5mm Mini-jack
Colors	Iron-gray/Silver
Speaker (Built-in)	2W x 2 Stereo
Power LED	Blue (ON)/ Amber (Stand-By)
VESA wall mount	100 x 100mm
Kensington lock	Yes
Power source	AC: 100~240V 50Hz/60Hz
Power consumption	Power On: < 50W, Standby: < 2W



(continued on the next page)

Specification summary (MB19SE)

Tilt	+20°~-5°
Dimension	412.6 mm x 224mm x 406.8mm
Multi-languages (OSD)	10 Languages (English, German, Italian, French, Dutch, Spanish, Russian, Traditional Chinese, Simplified Chinese, Japanese)
Accessories	VGA cable, audio cable, power cord, Support CD, quick start guide, warranty card (optional)
Regulation approvals	TC003, Energy Star 2006, UL/cUL, CB, CE,FCC, CCC, BSMI, Gost-R, C-Tick, PSB, MIC, WHQL

* Specifications are subject to change without notice.

Specification summary (MB19TU)

Panel Type	TFT LCD
Panel size	19.0" Standard screen
Max. Resolution	SXGA 1280 x 1024
Pixel pitch	0.294mm
Brightness (Typ.)	320cd/m ²
Contrast Ratio (Typ.)	800:1
Viewing angle(H/V)	160°/160°
Display colors	16.2M
Response time	2ms (Gray to Gray)/ 6ms (Tr+Tf)
SPLendid™ Video Enhancement	Yes
Splendid selection	5 Video Preset Modes (by  hotkey)
Auto adjustment	Yes (by  hotkey)
Color temperature selection	3 modes (9300°K/7500°K/6500°K)
Skin-Tone selection	3 modes
DVI port	24-Pin DVI-D
VGA port	15-Pin D-Sub
Audio-in port	3.5mm Mini-jack
Headphone port	3.5mm Mini-jack
Colors	Silver + Black
Speaker (Built-in)	2W x 2 Stereo
Power LED	Blue (ON)/ Amber (Stand-By)
VESA wall mount	100 x 100mm
Kensington lock	Yes
Power source	AC: 100~240V 50Hz/60Hz
Power consumption	Power On: < 50W, Standby: < 2W



(continued on the next page)

Specification summary (MB19TU)

Tilt	+20°~-5°
Dimension	412.6 mm x 224mm x 406.8mm
Multi-languages	English, German, Italian, French, Dutch, Spanish, Russian, Traditional Chinese, Simplified Chinese, Japanese
Accessories	VGA cable, DVI cable, audio cable, power cord, support CD, quick start guide, warranty card (optional)
Regulation approvals	Energy Star 2006, UL/cUL, CB, CE,FCC, CCC, BSMI, Gost-R, C-Tick, PSB, MIC, WHQL

* Specifications are subject to change without notice.

Specification summary (MB17SE)

Panel Type	TFT LCD
Panel size	17.0" Standard screen
Max. Resolution	SXGA 1280 x 1024
Pixel pitch	0.264mm
Brightness (Typ.)	300cd/m ²
Contrast Ratio (Typ.)	700:1
Viewing angle(H/V)	160°/160°
Display colors	16.2M
Response time	5ms (Tr+Tf)
SPLendid™ Video Enhancement	Yes
Splendid selection	5 Video Preset Modes (by  hotkey)
Auto adjustment	Yes (by  hotkey)
Color temperature selection	3 modes (9300°K/7500°K/6500°K)
Skin-Tone selection	3 modes
DVI port	--
VGA port	15-Pin D-Sub
Audio-in port	3.5mm Mini-jack
Headphone port	3.5mm Mini-jack
Colors	Iron-gray/Silver
Speaker (Built-in)	2W x 2 Stereo
Power LED	Blue (ON)/ Amber (Stand-By)
VESA wall mount	100 x 100mm
Kensington lock	Yes
Power source	AC: 100~240V 50Hz/60Hz
Power consumption	Power On: < 50W, Standby: < 2W

(continued on the next page)

Specification summary (MB17SE)

Tilt	+20°~-5°
Dimension	412.6 mm x 224mm x 406.8mm
Multi-languages	English, German, Italian, French, Dutch, Spanish, Russian, Traditional Chinese, Simplified Chinese, Japanese
Accessories	VGA cable, audio cable, power cord, support CD, quick start guide, warranty card (optional)
Regulation approvals	TCO03, Energy Star 2006, UL/cUL, CB, CE,FCC, CCC, BSMI, Gost-R, C-Tick, PSB, MIC, WHQL

* Specifications are subject to change without notice.

3.4 Supported operating modes

Standard	Resolution	Horizontal Frequency	Vertical Frequency	Pixel Frequency
DQS	720 x 400	31.47KHz	70Hz	28.32MHz
VGA	640 x 480	31.47KHz	60Hz	25.18MHz
	640 x 480	37.90KHz	72Hz	31.50MHz
	640 x 480	37.50KHz	75Hz	31.50MHz
SVGA	800 x 600	35.16KHz	56Hz	36.00MHz
	800 x 600	37.90KHz	60Hz	40.00MHz
	800 x 600	48.10KHz	72Hz	50.00MHz
	800 x 600	46.90KHz	75Hz	49.50MHz
XGA	1024 x 768	48.40KHz	60Hz	65.00MHz
	1024 x 768	56.50KHz	70Hz	75.00MHz
	1024 x 768	60.02KHz	75Hz	78.75MHz
SXGA	1280 x 1024	64.00KHz	60Hz	108.00MHz
	1280 x 1024	78.00KHz	75Hz	135.00MHz

* Modes not listed in the table may not be supported. For optimal resolution, we recommend that you choose a mode listed in the table above.

