

2218PH User's Manual

About This Guide

This guide describes the monitor's features, setup, and operation. **Information in this document is subject to change without notice.**

The sections are as follows:

- [Safety Instructions](#): lists safety information.
- [Setup](#): describes the initial setup process.
- [Using the Monitor](#): gives an overview of how to use the monitor.
- [Drivers](#): provides driver installation instructions for Windows.
- [Technical Support](#): provides tips and solutions for common problems.
- [Product Information](#): lists the technical specifications of the monitor.
- [Warranty Statement](#): Warranty Statement used in Europe.

National Conventions

The following subsections describe notational conventions used in this document.

Notes, Cautions, and Warnings

Throughout this guide, blocks of text may be accompanied by an icon and printed in bold type or in italic type. These blocks are notes, cautions, and warnings, and they are used as follows:



NOTE: A NOTE indicates important information that helps you make better use of your computer system.



CAUTION: A CAUTION indicates either potential damage to hardware or loss of data and tells you how to avoid the problem.



WARNING: A WARNING indicates the potential for bodily harm and tells you how to avoid the problem.

Some warnings may appear in alternate formats and may be unaccompanied by an icon. In such cases, the specific presentation of the warning is mandated by regulatory authority.

Product Registration

Please link www.aoc.com, select your country or region, log in Product Registration to register.

FCC Notice

FCC Class B Radio Frequency Interference Statement WARNING: (FOR FCC CERTIFIED MODELS)

NOTE: This equipment has been tested and found to comply with the limits for a Class B digital device, pursuant to Part 15 of the FCC Rules. These limits are designed to provide reasonable protection against harmful interference in a residential installation. This equipment generates, uses and can radiate radio frequency energy, and if not installed and used in accordance with the instructions, may cause harmful interference to radio communications. However, there is no guarantee that interference will not occur in a particular installation. If this equipment does cause harmful interference to radio or television reception, which can be determined by turning the equipment off and on, the user is encouraged to try to correct the interference by one or more of the following measures:

1. Reorient or relocate the receiving antenna.
2. Increase the separation between the equipment and receiver.
3. Connect the equipment into an outlet on a circuit different from that to which the receiver is connected.
4. Consult the dealer or an experienced radio/TV technician for help.

NOTICE :

1. The changes or modifications not expressly approved by the party responsible for compliance could void the user's authority to operate the equipment.
2. Shielded interface cables and AC power cord, if any, must be used in order to comply with the emission limits.
3. The manufacturer is not responsible for any radio or TV interference caused by unauthorized modification to this equipment. It is the responsibilities of the user to correct such interference.

WEEE Declaration

Disposal of Waste Equipment by Users in Private Household in the European Union.



This symbol on the product or on its packaging indicates that this product must not be disposed of with your other household waste. Instead, it is your responsibility to dispose of your waste equipment by handing it over to a designated collection point for the recycling of waste electrical and electronic equipment. The separate collection and recycling of your waste equipment at the time of disposal will help to conserve natural resources and ensure that it is recycled in a manner that protects human health and the environment. For more information about where you can drop off your waste equipment for recycling, please contact your local city office, your household waste disposal service or the shop where you purchased the product .

HG Declaration

 SAFETY: Lamp Disposal

LAMP(S) INSIDE THIS PRODUCT CONTAIN MERCURY AND MUST BE RECYCLED OR DISPOSED OF ACCORDING TO LOCAL, STATE OR FEDERAL LAWS. FOR MORE INFORMATION, CONTACT THE ELECTRONIC INDUSTRIES ALLIANCE AT WWW.EIAE.ORG.

Precautions



WARNING: Use of controls, adjustments, or procedures other than those specified in this documentation may result in exposure to shock, electrical hazards, and/or mechanical hazards.

Read and follow these precautions when connecting and using your computer monitor:

PRECAUTIONS

- Do not use the monitor near water, e.g. near a bathtub, washbowl, kitchen sink, laundry tub, swimming pool or in a wet basement.
- Do not place the monitor on an unstable cart, stand, or table. If the monitor falls, it can injure a person and cause serious damage to the appliance. Use only a cart or stand recommended by the manufacturer or sold with the monitor. If you mount the monitor on a wall or shelf, use a mounting kit approved by the manufacturer and follow the kit instructions.
- Slots and openings in the back and bottom of the cabinet are provided for ventilation. To ensure reliable operation of the monitor and to protect it from overheating, be sure these openings are not blocked or covered. Do not place the monitor on a bed, sofa, rug, or similar surface. Do not place the monitor near or over a radiator or heat register. Do not place the monitor in a bookcase or cabinet unless proper ventilation is provided.
- The monitor should be operated only from the type of power source indicated on the label. If you are not sure of the type of power supplied to your home, consult your dealer or local power company.
- The monitor is equipped with a three-pronged grounded plug, a plug with a third (grounding) pin. This plug will fit only into a grounded power outlet as a safety feature. If your outlet does not accommodate the three-wire plug, have an electrician install the correct outlet, or use an adapter to ground the appliance safely. Do not defeat the safety purpose of the grounded plug.
- Unplug the unit during a lightning storm or when it will not be used for long periods of time. This will protect the monitor from damage due to power surges.
- Do not overload power strips and extension cords. Overloading can result in fire or electric shock.
- Never push any object into the slot on the monitor cabinet. It could short circuit parts causing a fire or electric shock. Never spill liquids on the monitor.
- Do not attempt to service the monitor yourself; opening or removing covers can expose you to dangerous voltages and other hazards. Please refer all servicing to qualified service personnel.
- To ensure satisfactory operation, use the monitor only with UL listed computers which have appropriate configured receptacles marked between 100 - 240V AC, Min. 5A.
- The wall socket shall be installed near the equipment and shall be easily accessible.
- For use only with the attached power adapter (Output 12Vdc) which have **UL,CSA** listed license(Only for monitors with power adapter).
- Please make sure to clean the cabinet regularly with the provided cloth , you can use soft-cleanser to clean the stain , instead of severe spray cleanser which will cauterize the monitor cabinet.
- Dont leak liquid into monitor which will result in the damage of chassis or component. Please unplug before cleaning ,and do not scratch the screen with hard things.

Setup the stand and base

Please setup or remove the base following below steps.

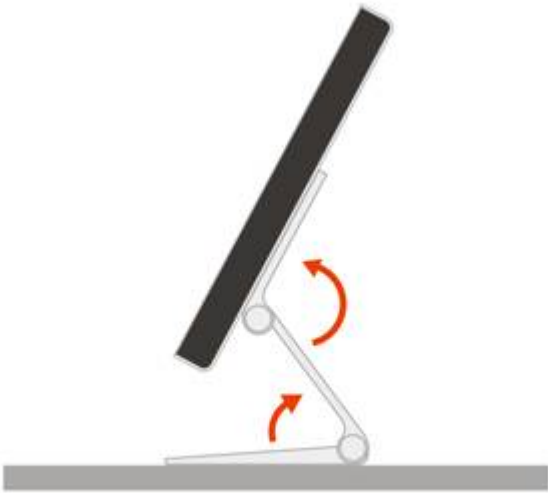

Adjusting Viewing Angle

- For optimal viewing it is recommended to look at the full face of the monitor, then adjust the monitor's angle to your own preference.
- Hold the stand so you do not topple the monitor when you change the monitor's angle.
- You are able to adjust the monitor's angle from -5° to 30° .

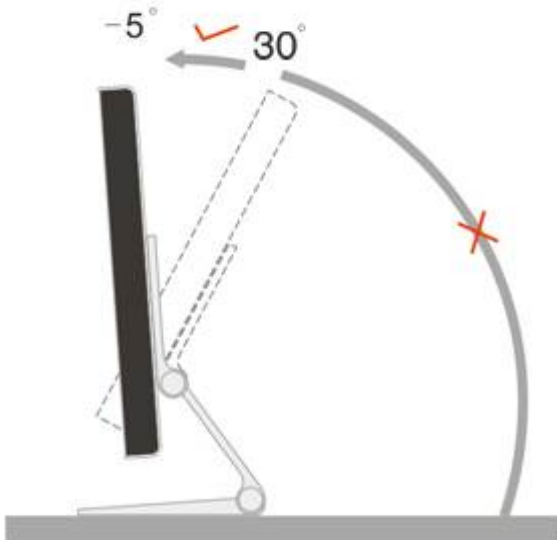

NOTE:
Do not touch the LCD screen when you change the angle. It may cause damage or break the LCD screen.

Attaching the Cables

Cable Connections On Back of Monitor and Computer

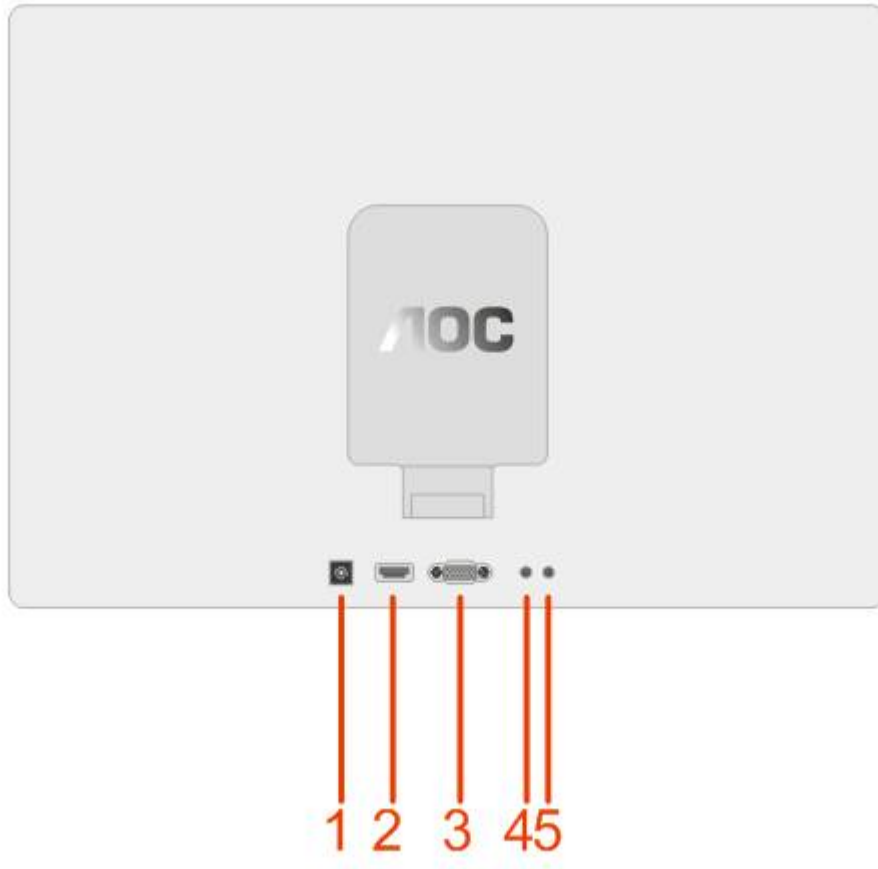

1. Power
2. HDMI
3. Analog
4. Audio
5. Earphone

Turn off your computer before performing the procedure below.

1. Connect the power cable to the AC port on the back of the monitor.
2. Connect one end of the 15-pin D-Sub cable to the back of the monitor and connect the other end to the computer's D-Sub port.
3. (Optional "C Requires a video card with HDMI port) - Connect one end of the HDMI cable to the back of the monitor and connect the other end to the computer's HDMI port.
4. Connect the audio cable to audio in port on the back of the monitor
5. Turn on your monitor and computer.

If your monitor displays an image, installation is complete. If it does not display an image, see [Troubleshooting](#).

Attaching Wall Mounting Arm

Preparing to Install An Optional Wall Mounting Arm

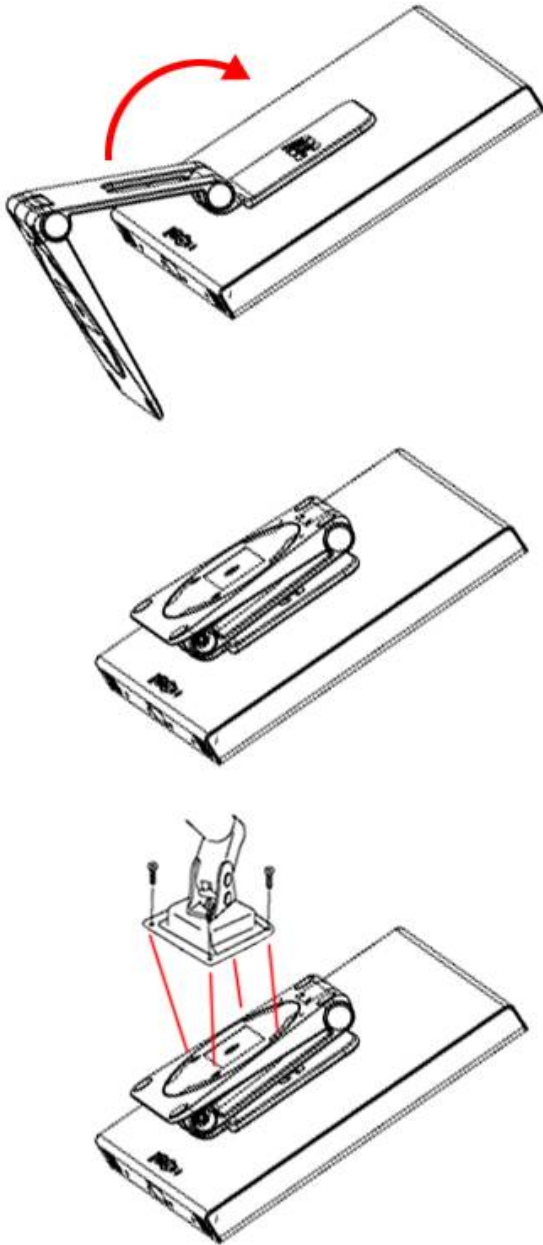

This monitor can be attached to a wall mounting arm you purchase separately. Disconnect power before this procedure. Follow these steps:

1. Follow the manufacturer's instructions to assemble the wall mounting arm.
2. Place the wall mounting arm onto the back of the monitor. Line up the holes of the arm with the holes in the back of the monitor.
3. Insert the 4 screws into the holes and tighten.
4. Reconnect the cables. Refer to the user's manual that came with the optional wall mounting arm for instructions on attaching it to the wall.

Noted : VESA mounting screw holes are not available for all models, please check with the dealer or official department of AOC.

Setting the Optimal Resolution

The recommended resolution for this monitor is 1680 by 1050. To setup the monitor to this resolution, follow the steps below.

1. Click **START**.
2. Click **SETTINGS**.
3. Click **CONTROL PANEL**.
4. Double click **DISPLAY**.
5. Click **SETTINGS**.
6. Set the resolution **SLIDE-BAR** to 1680 by 1050.

External Controls

Press the power button to turn the monitor on or off. The other control knobs are located at front panel of the monitor (See Figure). By changing these settings, the picture can be adjusted to your personal preferences.

* The power cord should be connected.

* Press the power button to turn on the monitor. The power indicator will light up.

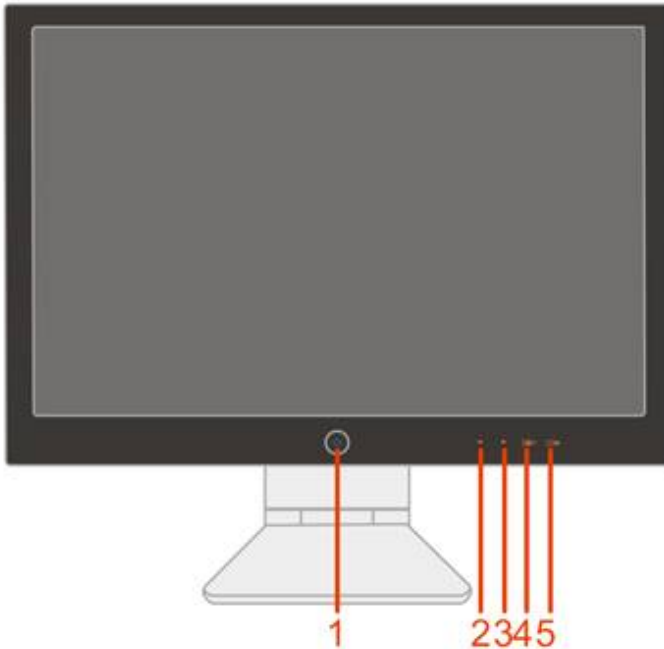

- 1 Power Button /Menu
- 2 Eco mode /-
- 3 Volume /+
- 4 Source / Enter
- 5 Auto / Exit

OSD Settings

- Press the MENU-button to activate the OSD window.
- Press+ or - to navigate through the functions. Once the desired function is highlighted, press the Enter-button to activate it. If the function selected has a sub-menu, press s+ or - again to navigate through the sub-menu functions. Once the desired function is highlighted, press Enter-button to activate it.
- Press+ or - to change the settings of the selected function. To exit and save, select the exit function. If you want to adjust any other function, repeat steps 2-3.
- OSD Lock Function: To lock the OSD, press and hold the Source / Enter button while the monitor is off and then press power button to turn the monitor on. To un-lock the OSD - press and hold the Source / Enter button while the monitor is off and then press power button to turn the monitor on.
- Eco Mode hot key : Press the Eco key continuously to select the Eco mode of brightness when there is no OSD (Eco mode hot key may not be available in all models).
- Volume adjustment hot key : When there is no OSD , press Volume (+) to active volume adjustment bar, press - or + to adjust volume (Only for the models with speakers).
- Source hot key : When the OSD is closed, press Source / Enter button will be Source hot key function (Only for the models with dual or more inputs) .Press Source button continuously to select the input source showed in the message bar , press Menu button to change to the source selected.

- Auto configure hot key: When the OSD is closed, press Auto button will be auto configure hot key function .



DCB Adjustment



Dynamic Color Boost

What is DCB?

Dynamic Color Boost (DCB) is an advanced color adjustment technology. Through analyzing RGB signals, DCB creates more vivid and natural images to suit various color environment needs. DCB has two types of color enhancers: “Color Boost” and “Picture Boost” .

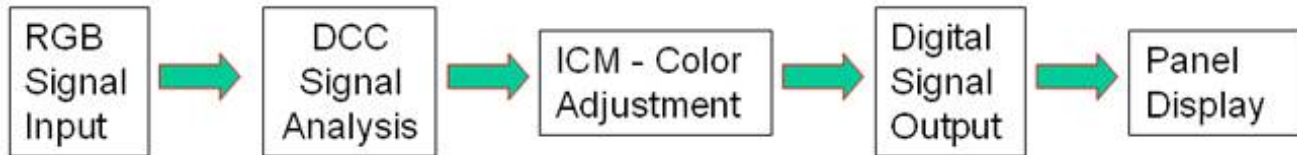

DCC: Dynamic color control
 ICM: Intelligent color management

1) How to use Color Boost?

Five color-enhancement settings: To accommodate various display needs, Color Boost also offers 5 different color enhancement modes: Full Enhance, Natural Skin, Green Field, Sky Blue, and Auto-Detect. Please go to the fourth icon labeled “Color Boost” in the OSD menu and select one of the five settings you desire to be turned on.



Full Enhance: When "Full Enhance" is turned on, the color saturation of the entire screen is fully enriched, thus all colors become more vibrant.



Nature Skin: When "Natural Skin" is turned on, the red and yellow colors are enriched automatically, thus presents human skin with more natural and truer colors. "Natural Skin" setting is ideal for viewing human portrait and detailed skin texture.



Green Field: When "Green Field" is turned on, the green color is enriched so that football field and mountain landscape would look more natural and fresh. "Green Field" setting is ideal for watching mountain scenery and outdoor sports.



Sky Blue: When "Sky Blue" is turned on, the color blue is being fine-tuned so that the sky or ocean landscape will look more vivid and in-depth. "Sky Blue" setting is ideal for viewing sky and ocean images.



Auto Detect: When "Auto Detect" is turned on, every pigment will be detected and self-adjusted to render a lively picture.



Demo: Screen divided into two for demonstration purposes.

2) How to use Picture Boost?

Users can change the color settings of a self-selected zone on the screen. The size and position of the selected zone can also be adjusted. "Picture Boost" is located in the fifth icon labeled "Picture Boost" in the OSD menu. Turn on "Bright Frame" to select a zone

on the screen to be enhanced. Please note when adjust or turn on any one of the DCB features, the rest of color settings including DCR will be disabled or return to default.



Disclaimer: DCB aftereffects are subject to the resolution and quality of the display content, hence may look different than the above illustrations.

DCR Adjustment



Dynamic Contrast Ratio

What is DCR?

Dynamic Contrast Ratio (DCR) auto adjusts the brightness of the screen so users can see the darker areas of the displayed content in more depths. By increasing the darkness of the dark areas and the brightness of the bright areas, contrast ratio is uplifted to exceed 10000:1. DCR value varies subject to the original CR values of the LCD module. The higher the original CR, the higher DCR can be achieved. DCR is great for watching movie or video contents.

How to Use DCR?

Go to the first OSD icon labeled "Luminance", turn on or off DCR as desires. DCR boosts the contrasts between lightness & darkness and enables the viewer to see more layers and details of the picture, especially in the darker areas. Please note when DCR is on, DCB will be disabled.

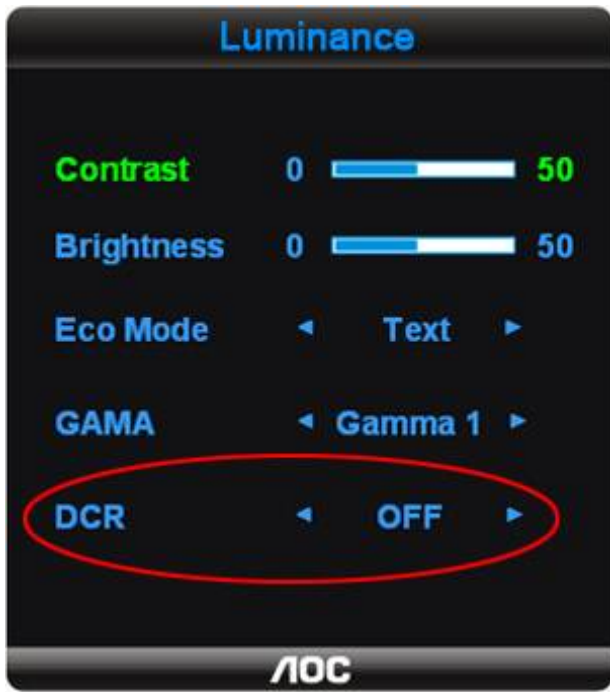

















DCR Demos:



Disclaimer: DCR aftereffects are subject to the resolution and quality of the display content, hence may look different than the above illustrations.

Function Control Illustration

	Luminance	Adjust Range	Description	
	Brightness	0-100	Backlight Adjustment	
	Contrast	0-100	Contrast from Digital-register.	
	Eco mode	Standard		Standard Mode
		Text		Text Mode
		Internet		Internet Mode
		Game		Game Mode
		Movie		Movie Mode
		Sports		Sports Mode
	Gamma	Gamma1		Adjust to Gamma1
		Gamma2		Adjust to Gamma 2
		Gamma3		Adjust to Gamma 3
	DCR	Off		Disable dynamic contrast ratio
		On		Enable dynamic contrast ratio
		Image Setup		
		Clock	0-100	Adjust picture Clock to reduce Vertical-Line noise.
Phase		0-100	Adjust Picture Phase to reduce Horizontal-Line noise	
H.Position		0-100	Adjust the verticalposition of the picture.	
V.Position		0-100	Adjust the horizontal position of the picture.	
	Color Temp.			
	Warm	6500K	Recall Warm Color Temperature from EEPROM.	
	Normal	7300K	Recall Normal Color Temperature from EEPROM.	
	Cool	9300K	Recall Cool Color Temperature from EEPROM.	
	sRGB		Recall SRGB Color Temperature from EEPROM.	
	User	Red Green Blue	Red Gain from Digital-register Green Gain Digital-register. Blue Gain from Digital-register	
	Color Boost			
	Full Enhance	on or off	Disable or Enable Full Enhance Mode	
	Nature Skin	on or off	Disable or Enable Nature Skin Mode	
	Green Field	on or off	Disable or Enable Green Field Mode	
	Sky-blue	on or off	Disable or Enable Sky-blue Mode	
	AutoDetect	on or off	Disable or Enable AutoDetect Mode	

	Demo	on or off	Disable or Enable Demo
	Picture Boost		
	Frame Size	14-100	Adjust Frame Size
	Brightness	0-100	Adjust Frame Brightness
	Contrast	0-100	Adjust Frame Contrast
	Hue	0-100	Adjust Frame Hue
	Saturation	0-100	Adjust Frame Saturation
	Position	H. position V.position	Adjust Frame horizontal Position Adjust Frame vertical Position
	Bright Frame	on or off	Disable or Enable Bright Frame
	OSD Setup		
	H.Position	0-100	Adjust the vertical position of OSD
	V.Position	0-100	Adjust the horizontal position of OSD
	Timeout	5-120	Adjust the OSD Timeout
	Transparence	0-100	Adjust the transparence of OSD
	Language		Select the OSD language
	Extra		
	Input Select	Auto	Select to Auto Detect input signal
		Analog	Select Analog Sigal Source as Input
		HDMI	Select HDMI signal source as input (Only for the models with HDMI input)
	Auto Config	yes or no	Auto adjust the picture to default
	Image Ratio	wide or 4:3	Select wide or 4:3 format for display
	DDC-CI	yes or no	Turn ON/OFF DDC-CI Support
Information		Show the information of the main image and sub-image source	
	Reset		
	Reset	yes or no	Reset the menu to default
	Exit		
	Exit		Exit the main OSD

Notes:

- 1)If the product has only one signal input, the item of "Input Select" is disable to adjust.
- 2)If the product screen size is 4:3 or input signal resolution is wide format, the item of "Image Ratio" is disalbe to adjust.
- 3)One of DCR, Color Boost, and Picture Boost functions is active, the other two function is turned off accordingly.

LED Indicators

Status	LED Color
Full Power Mode	Green or Blue
Active-off Mode	Orange or red

How to use i-Menu software

Installation

Welcome to use "i-Menu" software by AOC. i-Menu makes it easy to adjust your monitor display setting by menus on the screen instead of OSD button on the monitor. Please click [here](#) to setup the software. To complete installation , please follow the installation guide .

Using “i-Menu”
1. Luminance



Luminance		Adjust Range	Description
	Contrast	0-100	Contrast from Digital-register.
	Brightness	0-100	Backlight Adjustment
	Eco mode	Standard	Standard Mode
		Text	Text Mode
		Internet	Internet Mode
		Game	Game Mode
		Movie	Movie Mode
		Sports	Sports Mode
	Gamma	Gamma1	Adjust to Gamma1
		Gamma2	Adjust to Gamma 2
		Gamma3	Adjust to Gamma 3
	DCR	Off	Disable dynamic contrast ratio
		On	Enable dynamic contrast ratio





	Reset	Reset the current page
---	-------	------------------------

Remarks:

- 1) If DCR is set to “on”, the other 4 items of Luminance cannot be adjusted.
- 2) If anyone of DCR, Color Boost and Bright Frame of Picture Boost is set to “on”, the others are set to “off” automatically.
- 3) The Brightness and Contrast can be adjusted only when Eco-mode is on “standard mode”.









2. Image setup



Image Setup		Adjust Range	Description
	Clock	0-100	Adjust picture Clock to reduce Vertical-Line noise.
	Phase	0-100	Adjust Picture Phase to reduce Horizontal-Line noise
	H.Position	0-100	Adjust the verticalposition of the picture.
	V.Position	0-100	Adjust the horizontal position of the picture.
	Reset		Reset the current page

3. Color Temperature



Color Temp.		Adjust Range	Description
Preset		Warm	Recall Warm Color Temperature from EEPROM.
		Normal	Recall Normal Color Temperature from EEPROM.
		Cool	Recall Cool Color Temperature from EEPROM.
		sRGB	Recall SRGB Color Temperature from EEPROM.
User		Red	Red Gain from Digital-register
		Green	Green Gain Digital-register.
		Blue	Blue Gain from Digital-register
	Reset		Reset the menu to default

Remarks:

- 1) When "User" is chosen, you can change the monitor color to your desired color by setting the value of R-G-B.
- 2) When "sRGB" is chosen, the Brightness, Contrast and Gamma can not be adjusted.

4. Color Boost









Color Boost		Adjust Range	Description
	Full Enhance	on or off	Disable or Enable Full Enhance Mode
	Nature Skin	on or off	Disable or Enable Nature Skin Mode
	Green Field	on or off	Disable or Enable Green Field Mode
	Sky-blue	on or off	Disable or Enable Sky-blue Mode
	AutoDetect	on or off	Disable or Enable AutoDetect Mode
	Demo		Disable or Enable Demo
	Reset		Reset the menu to default

Remarks:

- 1) There is only one item can be set to "on" except Demo. If you set any item to "on", the others are changed to "off" automatically.
- 2) If anyone of DCR, Color Boost and Bright Frame of Picture Boost is set to "on", the others are set to "off" automatically.

5. Picture Boost



Picture Boost		Adjust Range	Description
	Bright Frame	on or off	Disable or Enable Bright Frame
	Frame Size	14-100	Adjust Frame Size
	Brightness	0-100	Adjust Frame Brightness
	Contrast	0-100	Adjust Frame Contrast
	H. position	0-100	Adjust Frame horizontal Position
	V. position	0-100	Adjust Frame vertical Position
	Reset		Reset the menu to default

Remarks:

- 1) Only when Bright Frame is set to "on", the other 5 items can be adjusted.
- 2) If any of DCR, Color Boost and Bright Frame of Picture Boost is set to "on", the others are set to "off" automatically.





6. Setting



Setting	Adjust Range	Description
Auto on	on or off	Sets auto run when system starts
Display mode	on or off	Enable or Disable to show pattern when adjusting
Shows hints	on or off	Enable or Disable to show alerts and hints
Turn in hotkeys	on or off	Enable or Disable hotkeys for pivot functions
Auto Pivot	on or off	Enable or Disable Auto Pivot function
Programm language		Select the programm language
configuration files	Save or delete	Save or delete configuration files

7. Extra



Extra		Adjust Range	Description
	Pivot	0, 90, 180, 270 degree	Select to pivot image
	Reset	yes or no	Reset the monitor settings to the factory defaults
	Re-Scan	yes or no	To re-scan Plug and Play monitor
	Best resolution		Select display resolution from preset mode
	Auto Config	yes or no	Auto adjust the picture to default

8. Help



On this page, you can find the information of the monitor . Welcome to link our website and send email to us if you have any problem.

Compatibility :

i-Menu supports major graphic cards of ATI, Nvidia, Intel, VIA(S3). Please contact with us if your graphic card was not supported i-Menu software.

Specifications

LCD Panel	Model number	2218Ph
	Driving system	TFT Color LCD
	Viewable Image Size	558.68mm diagonal
	Pixel pitch	0.282mm(H) x 0.282mm(V)
	Video	R, G, B Analog Interface, HDMI
	Separate Sync.	H/V TTL
	Display Color	16.7M Colors
	Dot Clock	164 MHz
Resolution	Horizontal scan range	24 kHz - 80 kHz
	Horizontal scan Size(Maximum)	473.76mm
	Vertical scan range	56 Hz - 75 Hz
	Vertical scan Size(Maximum)	296.1mm
	Optimal preset resolution	1680 x 1050 (60 Hz)
	Highest preset resolution	1680 x 1050 (60 Hz)
	Plug & Play	VESA DDC2B/CI
	Input Connector	D-Sub 15pin ,HDMI
	Input Video Signal	Analog: 0.7Vp-p(standard), 75 OHM,HDMI
	Power Source	100~240VAC, 50/60Hz
	Power Consumption	Active < 49 W Standby < 2 W
Speakers	2 x 2.5W	
Physical Characteristics	Connector Type	15-pin Mini D-Sub ,HDMI
	Signal Cable Type	Detachable
	Dimensions & Weight:	
	Height (with base)	464.5 mm
	Width	520.2 mm
	Depth	213 mm
	Weight (monitor only)	8.5kg
	Weight (with packaging)	10.5 kg
Environmental	Temperature:	
	Operating	0° to 40°
	Non-Operating	-20°to 60°
	Humidity:	
	Operating	10% to 85% (non-condensing)
	Non-Operating	5% to 80% (non-condensing)
	Altitude:	
	Operating	0~ 3000m (0~ 10000 ft)
Non-Operating	0~ 5000m (0~ 15000 ft)	

EPA ENERGY STAR®



ENERGY STAR® is a U.S. registered mark. As an ENERGY STAR® Partner, AOC International (Europe) GmbH has determined that this product meets the ENERGY STAR® guidelines for energy efficiency.

Preset Display Modes

STAND	RESOLUTION	HORIZONTAL	VERTICAL
		FREQUENCY(kHz)	FREQUENCY(Hz)
VGA	640iA480 @60Hz	31.469	59.940
VGA	640iA480 @72Hz	37.861	72.809
VGA	640iA480 @75Hz	37.500	75.000
Dos-mode	720iA400 @70Hz	31.469	70.087
Dos-mode	640iA400 @71Hz	31.469	70.087
SVGA	800iA600 @56Hz	35.156	56.250
SVGA	800iA600 @60Hz	37.879	60.317
SVGA	848x480@60Hz	31.020	60.000
SVGA	800iA600 @72Hz	48.077	72.188
SVGA	800iA600 @75Hz	46.875	75.000
XGA	1024iA768 @60Hz	48.363	60.004
XGA	1024iA768 @70Hz	56.476	70.069
XGA	1024iA768 @75Hz	60.023	75.029
XGA	1024iA768 @75Hz	60.241	74.927
XGA	1280iA768 @60Hz	47.776	59.870
XGA	1280iA768 @60Hz	47.396	59.995
XGA	1280iA768 @75Hz	60.289	74.893
SXGA	1280iA1024 @60Hz	63.981	60.020
SXGA	1280iA1024 @70Hz	74.882	69.853
SXGA	1360x768@60Hz	47.712	60.015
WSXGA	1680iA1050 @60Hz	65.290	59.954
WSXGA+	1680x1050@60Hz	65.290	59.954

Pin Assignments

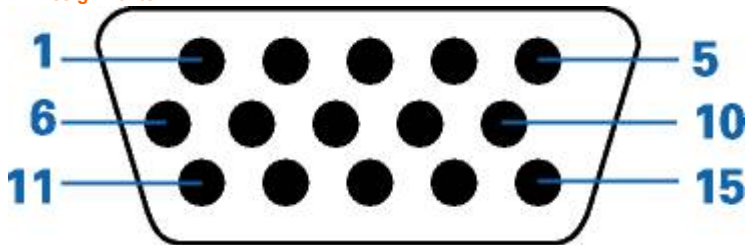

Pin Number	15-Pin Side of the Signal Cable
1	Video-Red
2	Video-Green
3	Video-Blue
4	N.C.
5	Detect Cable
6	GND-R
7	GND-G
8	GND-B
9	+5V
10	Ground
11	N.C.
12	DDC-Serial data
13	H-sync
14	V-sync
15	DDC-Serial clock

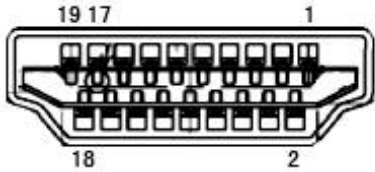

Pin No.	Signal Name	Pin No.	Signal Name	Pin No.	Signal Name
1	TMDS Data 2+	9	TMDS Data 0	17	DDC/CEC Ground
2	TMDS Data 2 Shield	10	TMDS Clock +	18	+5V Power
3	TMDS Data 2	11	TMDS Clock Shield	19	Hot Plug Detect
4	TMDS Data 1+	12	TMDS Clock		
5	TMDS Data 1Shield	13	CEC		
6	TMDS Data 1	14	Reserved (N.C. on device)		
7	TMDS Data 0+	15	SCL		
8	TMDS Data 0 Shield	16	SDA		

Plug and Play

Plug & Play DDC2B Feature

This monitor is equipped with VESA DDC2B capabilities according to the VESA DDC STANDARD. It allows the monitor to inform the host system of its identity and, depending on the level of DDC used, communicate additional information about its display capabilities. The DDC2B is a bi-directional data channel based on the I²C protocol. The host can request EDID information over the DDC2B channel.