



### One Year Limited Warranty

Amcor, Inc. ("Amcor") warrants the original retail purchaser ("Purchaser") purchasing in the United States that the Amcor product with which this warranty is enclosed is free from defects in materials and workmanship.

Amcor's sole obligation under this warranty is to replace, or at Amcor's discretion, to repair, free of charge, all defective parts, for a period of one (1) year from date of original purchase. ANY IMPLIED WARRANTY OF MERCHANTABILITY IS SIMILARLY LIMITED TO ONE (1) YEAR FROM DATE OF ORIGINAL PURCHASE AND NO ACTION BASED UPON ANY IMPLIED WARRANTY OF MERCHANTABILITY OR OTHERWISE MAY BE COMMENCED AFTER EXPIRATION OF ONE (1) YEAR FROM DATE OF ORIGINAL RETAIL PURCHASE. Some states do not allow limitations on how long an implied warranty lasts, so the above limitation may not apply to you.

The provisions of this warranty shall not apply to any product which in Amcor's judgment has been (1) subject to misuse or neglect. (2) damaged in an accident. (3) used for a purpose for which it was not designed, or (4) repaired or altered in any way that adversely affected its performance or reliability.

To obtain warranty service, the defective product or part must be shipped or delivered to: Amcor's authorized service center. All postage, insurance and shipping charges are the responsibility of the Purchaser and are not included in this warranty.

AMCOR NEITHER ASSUMES NOR AUTHORIZES ANY PERSON TO ASSUME FOR IT ANY OTHER ( LIABILITY IN CONNECTION WITH ITS PRODUCTS, THERE ARE NO WARRANTIES WHICH EXTEND BEYOND THE DESCRIPTION ON THE FACE HEREOF. NO RESPONSIBILITY IS ASSUMED FOR INCIDENTAL OR CONSEQUENTIAL DAMAGES THAT MAY RESULT FROM THE USE OF AN AMCOR PRODUCT, NOR FOR THE DAMAGES DUE TO ACCIDENT, ABUSE, LACK OF RESPONSIBLE CARE, THE AFFIXING OF ANY UNAUTHORIZED ATTACHMENT, LOSS OF PARTS, OR USE AT A VOLTAGE OTHER THAN SPECIFIED. Some states do not allow the exclusion of limitation of incidental or consequential damages, so these limitations may not apply to you.

Amcor disclaims all liabilities for defects or damages caused by use of replacement parts obtained from or by service at any service center other than Amcor's authorized service center.

This warranty gives you specific legal rights, and you may also have other rights which vary from state to state.

Product: **AMCOR Portable Air Conditioner** Model: AL-10,000E/EH  
Date Purchased: \_\_\_\_\_ Production Code: \_\_\_\_\_

QUESTIONS? Call 866-361-2233 · [www.amcorgroupusa.com](http://www.amcorgroupusa.com)

Dear Customer: Please keep this warranty for your record. **DO NOT** return it.

UltraClean®



# PORTABLE Air Conditioner

## Owner's Manual

For models AL-10,000E and AL-10,000EH



It is important that you read these instructions before using your new purchase and we strongly recommend that you keep them in a safe place for future reference.

## Troubleshooting

Problem	Cause	Solution
<b>Never try to repair or dismantle the air conditioner yourself. Tampering with the unit may result in the loss of warranty and can endanger the user and property.</b>		
<b>The Air Conditioner Does Not Function Properly</b>	Windows or doors are open.	Close doors and windows.
	The filter is dirty	Clean or replace filter.
	Air inlet or air outlet is blocked.	Remove blockage.
	Room temperature lower than the selected value.	Lower temperature selected.
	The overheat protection is activated.	Wait 3 minutes until temperature has decreased, then turn on again.
<b>The Unit Does Nothing</b>	No power supply	Make sure outlet works. Be sure Green Light is on (L.C.D.I. Plug) Press Re-start button.
	Water container is full.	Drain the Unit.
	Timer Function Set	Deactivate the Timer Function.
<b>The Unit is Noisy</b>	Unit is not standing on a level surface.	Place on an even surface.
<b>The Remote Control Does Not Function</b>	Distance too great.	Make sure the remote is aimed at the control panel.
	Remote control signal not detected by control panel.	Control is aimed at the control panel.
	Batteries are dead.	Replace the batteries.

**If you have any questions regarding the operation of the AL-10,000 please contact **AMCOR** at 1-866-361-2233**

### REPLACEMENT FILTERS:

To purchase Replacement Filters for this unit, contact **AMCOR** at 1-866-361-2233 and request model number **AL-10,000F**

If this product is defective or not working properly,  
**please DO NOT return to your retail store.**  
Please contact us directly for any Service or Technical Assistance at:

**1-866-361-2233**

**Amcorg Inc.**

[www.amcorgroupusa.com](http://www.amcorgroupusa.com)

## Table of Contents

THANK YOU.....	2
<i>Energy Saving Tips</i> .....	2
SPECIFICATIONS .....	3
BEFORE USE.....	4
PARTS .....	5
<i>Front, Back</i> .....	5
<i>Accessories</i> .....	5
INSTALLATION.....	6
<i>Window Kit Installation</i> .....	6
<i>Wall Connection</i> .....	6
<i>Mounting the Exhaust Pipe</i> .....	7
<i>Cleaning the Filter</i> .....	7
OPERATION .....	8
<i>Control Panel</i> .....	8
<i>Setting Mode / Function</i> .....	8
<i>Auto Mode</i> .....	8
<i>Setting the Temperature</i> .....	8
<i>Setting Fan Speed</i> .....	9
<i>Setting the Timer</i> .....	9
<i>Regulating Airflow Direction</i> .....	9
DRAINAGE.....	10
<i>How to Drain the Unit</i> .....	10
MAINTENANCE .....	11
<i>Cleaning the Housing</i> .....	11
<i>Cleaning the Filter</i> .....	11
<i>End of Season Storage</i> .....	11
<i>Storing the Power Cord</i> .....	11
TROUBLESHOOTING.....	12
WARRANTY .....	14

## Drainage

During the process of cooling, some water will be extracted from the air into the unit. Most of this water is used to cool the unit and make it run more efficiently. This is a feature not found in most Portable Air Conditioners. If the unit is operated in VERY HUMID air, water will collect in the container inside the unit. If the Internal Water Container is full, the backlight on the LCD display will flash, the unit will shut off, and it must be drained before it will re-start.

### How to Drain the Unit

Use a Shallow Container or Dish

1. Turn off the unit.
2. Position a flat container or dish under the drain hole. Do not allow the water to drip continuously into the container, as it might easily overflow.
3. Remove the drain knob & rubber plug from the drain hole. The condensed water will drain out automatically.
4. When the container is almost full, replace the rubber plug into the drain hole to stop the water. Empty the container.
5. Repeat steps 2, 3 & 4 until all the condensed water is emptied.
6. Once all the condensed water has been removed, replace the rubber plug into the drain hole firmly. The Full Water indicator should be off now.
7. Replace the drain knob.
8. Turn unit on, the unit will resume working.

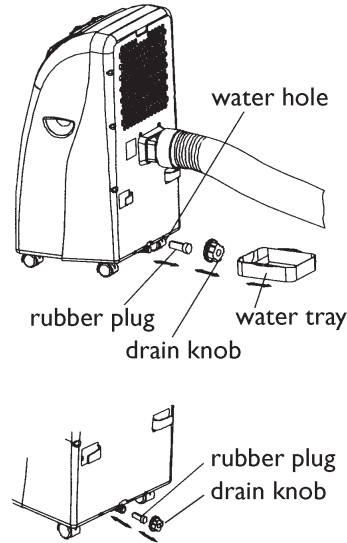

## Specifications

Model Number	AL-10,000E	AL-10,000EH
Cooling Capacity	10,000 BTU/hr	10,000 BTU/hr
Heating Capacity	N/A	10,000 BTU/hr
Power Consumption	660W / 6.0A	660W / 6.0A
Humidity Removal Capacity	38 Pts. / Day	38 Pts. / Day
Recommended room size*	Up to 300 sq. ft.	Up to 300 sq. ft.
Power Supply	115V / 60Hz / 1 Phase	115V / 60Hz / 1 Phase
Compressor	Rotary	Rotary
Refrigerant	R-22	R-22
Fan Speed	2	2
Timer	1-12 hours	1-12 hours
Temperature Set Range	62°F - 90°F	62°F - 90°F
Unit Weight	63 lbs.	66 lbs.
Dimensions	15"W x 16"D x 30"H	15"W x 16"D x 30"H
Working Temperature	Cooling: 62°F to 110°F	Cooling: 62°F to 110°F Heating: 41°F to 81°F

### REMARKS:

The cooling capacity of the unit may be affected by the height of the ceiling, quality of insulation, number of windows, etc.

## Operation

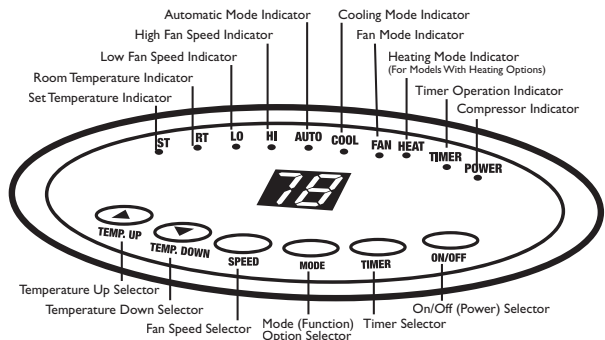

### Setting Mode/Function

Press the MODE button to select the required working mode: Automatic, Cooling, Fan or Heating (Heating is only available for AL-10,000EH). The green indicator illustrating your selected mode lights up. It is recommended to select Cooling or Heating mode and set your desired temperature, as the Auto mode has a preset temperature (please see below) that cannot be changed.

The indicators of the functions in progress come on at the same time, e.g. Cool and Lo = Cooling mode with Low fan speed.

### Auto Mode

When this mode is selected, the unit is preset to the following temperature settings and unit will only start to:

- Cool when room temperature is higher than 75°F
- Heat when room temperature is lower than 68°F (AL-10,000EH only)

If room temperature is between 68°F and 75°F, unit will stay in Fan mode. Again, when in Auto Mode, the temperature settings cannot be changed.

### Setting the Temperature in Cooling or Heating Mode

The display window's default is to display the ambient room temperature. The green indicator light under RT is on. (RT = Room Temperature)

To set your desired temperature, press the Temperature up or down buttons (ranging from 62°F to 90°F). Each press will increase or decrease your set temperature by 1°F. When pressing the temperature up or down buttons, the window will change to display your set temperature. At this time, the green indicator will light under ST (Set Temperature). Once the temperature up or down buttons is released, the window will return to displaying the ambient temperature after a second.

**Note:** When unit is in the following modes: Auto, Cool, or Heat - the compressor will cool/heat the room to reach the set temperature. Once the ambient temperature has reached the set temperature, the compressor will stop and unit will run in Fan mode. To conserve energy, the compressor will not start immediately after a couple degrees increase or decrease, but will wait for a 5°F allowance. For example:

#### In Cooling Mode with a set temperature of 70°F

When compressor first stops after reaching 70°F, unit will auto-switch to Fan. Compressor will start cooling again when ambient temperature increases to 75°F or above.

#### In Heating Mode with a set temperature of 72°F

When compressor first stops after reaching 72°F, unit will auto-switch to Fan. Compressor will start heating again when ambient temperature drops to 67°F or below.

#### In Auto Mode (with preset temperature of 68°F for heat and 75°F for cool)

Compressor will start cooling again when ambient temperature reaches above 80°F or will start heating when ambient temperature drops below 63°F.

## Parts

Front

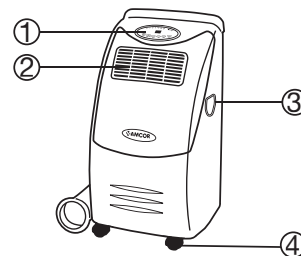

1. Control Panel
2. Cooling Air Outlet
3. Handle
4. Castors

Back

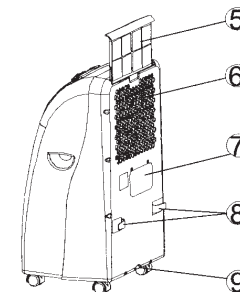

5. Air Filter
6. Air Inlet
7. Exhaust Air Outlet
8. Cord Hanger
9. Water Stopper (Rubber Plug Inside)

### Accessories

10. Adaptor - for insertion over the hose and into the back of the air conditioner
11. Exhaust Hose
12. Adjustable Slide Bar
13. Round Connector
14. Cap for Round Connector
15. Remote Control (Electronic control models only)

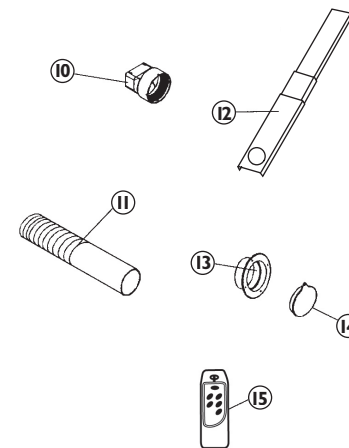

## Installation

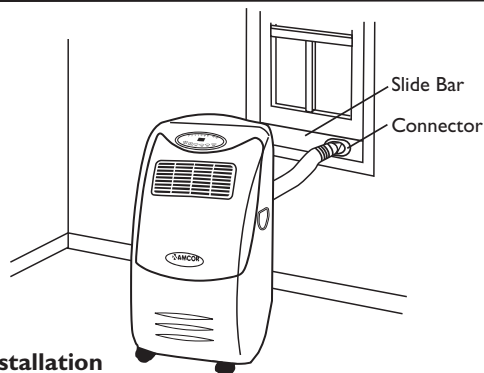

### Window Kit Installation

In order for this unit to function properly, it must be vented to the outside.

Fitting the Exhaust Hose through the window is easy. Please see below.

1. Extend Hose at least 6" and insert it into back of the unit, tightening into place by turning it clockwise.

2. Attach Slide Bar Connector, (Round Connector) to the other end of the Hose by extending hose at least 6". Then tighten Hose by turning the (Round Connector) clockwise.

3. Place Adjustable Slide Bar in the window and expand so it fits tightly.  
4. Lower the window.  
5. Make sure the Hose has no kinks.

Slide Bar has 3 sections which allows installation in windows up to 48" in width.

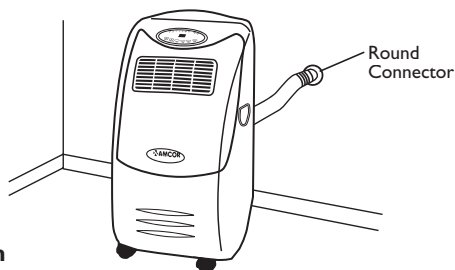

### Wall Connection

1. Make a hole (5.1" in diameter) in the wall.

2. Insert the Round Connector (part #13) into the hole and hold in place by using 4 small screws (not supplied).

3. Extend one end of the Exhaust Pipe (part #11) and screw into the Round Connector by turning clockwise.

4. Extend other end of exhaust pipe and screw in Adaptor (part #10) by turning clockwise.

5. Push Adaptor to fit firmly over the opening on the back of the unit.

\*\* When not in use, cover the Round Connector and hole with Cap (part #14).

## Installation

### Mounting the Exhaust Pipe

• The supplied Exhaust Hose can be extended from 1 foot to 5 feet for mounting. It is recommended that you use the shortest possible length of Hose.

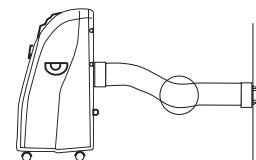

• Take care to prevent any kink or bend in the middle of the Exhaust Hose, as this will trap hot exhaust air, which will radiate back into the room.

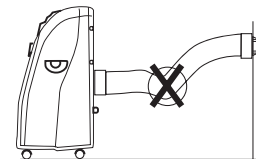
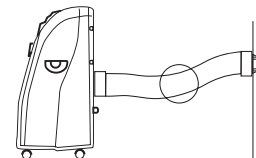

### WARNING!

The length of the Exhaust Pipe is specially designed according to the specification of this product.

Do not replace or extend it with your own hose as this could cause the unit to malfunction.

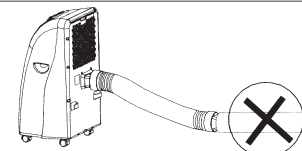

### Cleaning the Filter

Use a vacuum cleaner or tap the filter lightly to remove loose dust and dirt from the filters and then rinse them thoroughly under running water (no hotter than 104°F)

Dry thoroughly before replacing.

*Notice! Never operate the unit without the filters.*

## Before Use

### Important!

- Leave the unit in an upright position for at least 2 hours before use.
- Always place the unit on an even surface.
- The power cord has a built-in L.C.D.I. (Leakage, Current, Detection, Interruption) circuit breaker for added safety. If the power supply is interrupted, please press the reset button to reconnect the unit to the power source. The green light should be on.
- Make sure the unit is connected to a correctly grounded power supply.
- **For proper operation, the unit must be vented to the outside.**
- Do not cover or obstruct the appliance inlet or outlet grilles.
- To avoid the risk of shock, the product should never be used in bathrooms, shower rooms or in any other steamy or wet areas.
- Always transport the unit in an upright position.
- Do not sit or stand on the unit.
- Do not place objects on the unit.
- Do not touch the unit with wet/damp hands or when standing barefoot.
- **Drainage of the water container is required before moving the unit or putting it into storage.**
- If the electric socket is different from the plug provided, have a professionally qualified electrician replace the outlet with a suitable one. Avoid the use of adaptor plugs, multiple sockets and/or extension cords; if their use is necessary, ensure that they conform to the current safety regulations.
- Do not pull the power cord or place it near a source of heat; always unroll it completely to avoid the possibility of dangerous overheating.
- If the power cord is damaged, it must be replaced by a qualified person.

THE MANUFACTURER DISCLAIMS ANY RESPONSIBILITY IF THE ABOVE INSTRUCTIONS ARE NOT FOLLOWED.

## Operation

### Setting The Fan Speed

Press the SPEED button to choose the fan speed you require, high or low. The indicator of high or low fan will light up at the same time.

If the unit is in AUTO mode, it will select the fan speed automatically according to the ambient temperature (the related indicators, cool, fan or heat will light up), at this time the fan speed switch is invalid.

### Setting the Timer

Press the TIMER button to set the operating hours you desire (1 to 12 hours, the timer indicator will light up). When the set time has elapsed, the machine will turn off automatically. The display window will show the hour(s) you set as you press the TIMER button. If the timer button is not pressed, the unit will work continuously.

By pressing the timer button but without turning on the unit, you can PRE-SET the time for the machine to work. For example, if you press the timer to '2', the unit will come on automatically after 2 hours.

All the above functions can also be performed with the supplied remote control. This remote control requires 2 AAA batteries to operate.



### Regulating the Airflow Direction

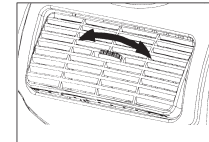

Turn the roller on the air vent to control the airflow direction from the vertical louvers.

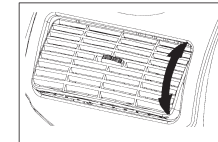

Move the air vent directly to adjust the airflow direction from the horizontal louvers.

### IMPORTANT!

- **The compressor will start approximately 3 minutes after the unit is turned on (this will help prolong the life of the compressor). After switching the unit off, please wait at least 3 minutes before turning the unit back on.**
- The cooling system will switch off if the room temperature is lower than set. The fan, however, keeps working at the set level. If the ambient temperature rises above the chosen temperature  $\pm 5^{\circ}\text{F}$ , the cooling will resume.
- In heating mode, the compressor will switch off if the room temperature is HIGHER than the one set (the fan keeps working at the set level). When the room temperature drops  $5^{\circ}\text{F}$  below the chosen temperature, heating will resume.
- This machine is equipped with an ANTI-FROST function. Sometimes, while using the heating function during low temperatures, the heating will stop for a while to melt the internal frost. When this occurs, wait for heating to resume.
- As you switch on the heating, the fan will stop for 15-20 seconds prior to the unit starting.

## Thank You!

Thank you for choosing the portable air conditioner from AMCOR, a leading brand in indoor air treatment. We would like you to enjoy the many benefits this unit offers, so please read this manual carefully and take full advantage of the many advanced features that your AMCOR Air Conditioner offers you.

AMCOR has specialized in complete indoor environment control, manufacturing world-class air conditioners, dehumidifiers and air purifiers with innovative technology. In designing these advanced products, we have listened carefully to our customers and have passed their views on to our research and development laboratories.

We wish you many years of enjoyable use.

After reading this manual, please keep it in a safe place for future reference.

### Energy Saving Tips

- Do not locate the air conditioner where furniture or other objects can obstruct the airflow.
- Keep doors closed so cool air does not escape.
- Keep the filters clean.

Set the unit to maximum cooling and high speed fan initially, then adjust the unit to a comfortable setting.

**NOTE: Use the Temperature Control (UP/DOWN) to adjust Air Conditioner cooling to a desired level.**

## Maintenance

**Always unplug the unit from the wall outlet before beginning the cleaning.**

### Cleaning the Housing

Use a soft, damp cloth to wipe the body clean.

Never use strong chemicals, oil-based products, detergents, chemically treated cloths or other cleaning solutions. These could possibly damage the cabinet.

### Cleaning the Filter

Use a vacuum cleaner or tap the filter lightly to remove loose dust and dirt from the filters and then rinse them thoroughly under running water (no hotter than 104°F).

Dry thoroughly before replacing.

Do not wet the activated carbon filter, remove from frame before rinsing.

**IMPORTANT! Never operate the unit without the filters.**

### End of Season Storage

Unplug the unit.

Drain the condensed water **COMPLETELY** (please refer to page 10).

Clean or change the filter.

On a warm day, turn the unit to fan mode for a couple of hours so that the inside can dry out completely.

It is recommended that the unit be put back into its original carton for storage.

Do not stack heavy objects on top of the unit.

### Storing The Power Cord

When the unit is not in use, please store the power cord away as shown.

